

Pescara PTX110-25 Stainless Steel

Pescara delivers timeless appeal by evoking Italian traditions and artisan culture. The essential lines and generous dimensions create a refined oasis and luxurious atmosphere, for the ultimate livable kitchen. A complete selection of accessories maximizes the efficiency of the Pescara sink with the same level of detail and quality Franke is known for.

Product Picture

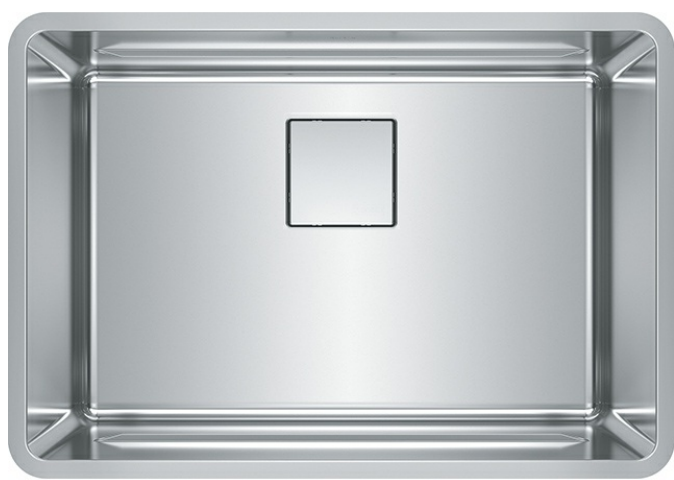

Technical Drawing

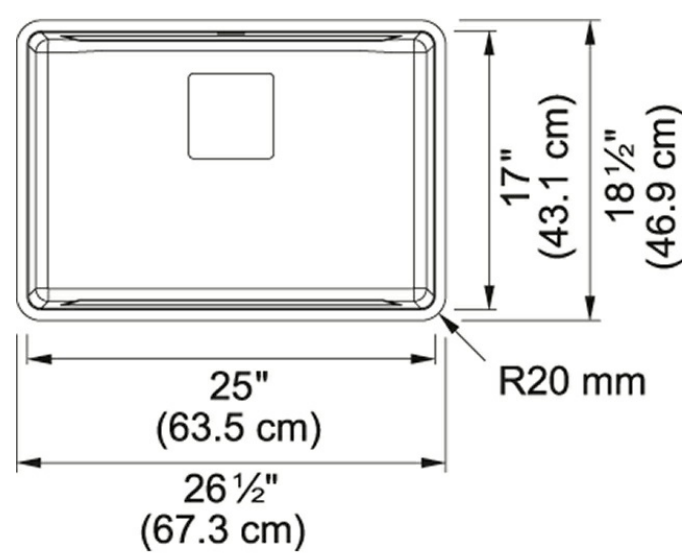

Product Dimensions

Length overall	18 1/2"
Width overall	26 1/2"
Depth Overall	9 1/2"
Length of large bowl	17"
Width of large bowl	25"
Minimum Cabinet Size	30"

General Information

Cut-Out Template	Yes
Franke Integral Ledge	BUILT-IN
Where to buy	Showroom

Article Numbers

FUN#	122.0491.565
US Part Number	PTX110-25

