

UTY-TERX

INSTALLATION MANUAL

EXTERNAL SWITCH CONTROLLER

For authorized service personnel only.

English

INSTALLATIONSANLEITUNG

EXTERNE SCHALTERSTEUERUNG

Nur für autorisiertes Fachpersonal.

Deutsch

MANUEL D'INSTALLATION

COMMANDE DE COMMUTATEUR EXTERNE

Pour le personnel agréé uniquement.

Français

MANUAL DE INSTALACIÓN

CONTROL EXTERNO DE INTERRUPTORES

Únicamente para personal de servicio autorizado.

Español

MANUALE DI INSTALLAZIONE

DISPOSITIVO DI CONTROLLO ESTERNO

A uso esclusivo del personale tecnico autorizzato.

Italiano

ΕΓΧΕΙΡΙΔΙΟ ΕΓΚΑΤΑΣΤΑΣΗΣ

ΕΛΕΓΚΤΗΣ ΕΞΩΤΕΡΙΚΟΥ ΔΙΑΚΟΠΤΗ

Μόνο για εξουσιοδοτημένο τεχνικό προσωπικό.

Ελληνικά

MANUAL DE INSTALAÇÃO

CONTROLO EXTERNO DE COMUTADORES

Apenas para técnicos autorizados.

Português

РУКОВОДСТВО ПО УСТАНОВКЕ

КОНТРОЛЛЕР ВНЕШНЕГО ПЕРЕКЛЮЧАТЕЛЯ

Только для авторизованного обслуживающего персонала.

Русский

MONTAJ KILAVUZU

HARICI ANAHTARLAMA KUMANDASI

Yalnızca yetkili servis personeli için.

Türkçe

安装说明书

外部开关控制器

仅针对授权的专业维修人员。

中文

富士通将军有限公司

FUJITSU GENERAL LIMITED



[Original instructions]

PART NO. 9374707157-02

INSTALLATION MANUAL

PART NO. 9374707157-02
EXTERNAL SWITCH CONTROLLER

Contents

1. SAFETY PRECAUTIONS	1
2. MAIN UNIT AND ACCESSORIES	1
3. ELECTRICAL REQUIREMENT	1
4. SELECTING AN INSTALLATION LOCATION	2
4. 1. Dimensions	2
4. 2. Specifications	2
5. WIRING	2
5. 1. Wiring method	3
5. 2. Unit wiring	3
6. INSTALLING THE EXTERNAL SWITCH CONTROLLER	4
6. 1. Connecting the cables	4
7. CONNECTION OF REMOTE CONTROLLER CABLE	5
8. CONNECTION OF EXTERNAL INPUT CABLE	6
9. CIRCUIT BOARD SETTING	6
10. ABOUT SWITCH SETTING	9
11. EXAMPLE SETTING	9
12. TURNING ON THE POWER	10
13. LED DISPLAY	10
13. 1. Normal code	10
13. 2. Error code	10

1. SAFETY PRECAUTIONS

- The "SAFETY PRECAUTIONS" indicated in this manual contain important information pertaining to your safety. Be sure to observe them.
- Request the user to keep this manual on hand for future use, such as for relocating or repairing the unit.

WARNING

This mark indicates procedures which, if improperly performed, might lead to the death or serious injury of the user.

Perform electrical work by an authorized service personnel in accordance with this manual and the electrical wiring regulations or implementation regulations of the country. Also do not install this unit by yourself. Improper electric work will cause electric shock or a fire.

Perform installation work in accordance with this manual. Request an authorized service personnel to perform installation work. Do not install this unit by yourself. Improper installation will cause injury, electric shock, fire, etc.

In the event of a malfunction (burning smell, etc.), immediately stop operation, turn off the electrical breaker, and consult authorized service personnel.

Do not install the unit in the following areas:

- Do not install the unit near a source of heat, steam, or flammable gas.
- Area filled with mineral oil or containing a large amount of splashed oil or steam, such as a kitchen. It will deteriorate plastic parts, causing the parts to fail or the unit to leak water.
- Area that generates substances that adversely affect the equipment, such as sulfuric gas, chlorine gas, acid, or alkali. It will cause the copper pipes and brazed joints to corrode, which can cause refrigerant leakage.
- Area containing equipment that generates electromagnetic interference. It will cause the control system to malfunction, preventing the unit from operating normally.
- Area that can cause combustible gas to leak, contains suspended carbon fibers or flammable dust, or volatile inflammables such as paint thinner or gasoline. If gas leaks and settles around the unit, it can cause a fire.
- Do not use the unit for special purposes, such as storing food, raising animals, growing plants, or preserving precision devices or art objects. It can degrade the quality of the preserved or stored objects.
- Install the unit in a well-ventilated place avoiding rains and direct sunlight.

Do not operate this unit when your hands are wet. Touching the unit with wet hands will cause an electric shock.

If children may approach the unit, take preventive measures so that they cannot reach the unit.

CAUTION

This mark indicates procedures which, if improperly performed, might possibly result in personal harm to the user or damage to property.

Pay abundant care when transporting this unit because it is a precision device. Improper transportation will cause trouble.

Do not touch the switches with sharp objects. Doing so will cause injury, trouble, or electric shock.

Do not expose this unit directly to water. Doing so will cause trouble, electric shock, or heating.





Do not set vessels containing a liquid on this unit. Doing so will cause heating, fire, or electric shock.

Dispose of the packing materials safely. Tear and dispose of the plastic packing bags so that children cannot play with them. There is the danger of suffocation if children play with the original plastic bags.

Do not insert articles into the slit parts of this unit. Doing so will cause trouble, heating, or electric shock.

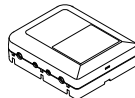
2. MAIN UNIT AND ACCESSORIES

The following installation parts are supplied. Use them as required.

Name and Shape	Q'ty	Application
External switch controller 	1	This product
Installation manual 	1	This manual
Cable tie 	4	For mounting the remote controller cable and external input cable.
Screw (M4 x 16 mm) 	3	For mounting this product

3. ELECTRICAL REQUIREMENT

Use	Size	Cable type	Remarks
Remote controller cable (2-wire type)	0.33 to 1.25 mm ² (16~22AWG)	Sheathed PVC cable*	Non-polar 2 core, twisted pair (Maximum cable length: 500m (1,640 ft))
Remote controller cable (3-wire type)	0.33 mm ² (22AWG)	Sheathed PVC cable*	Polar 3core, twisted pair (Maximum cable length: 25m (82 ft))
External input cable	0.33 to 1.25 mm ² (16~22AWG)	Sheathed PVC cable*	2 core, twisted pair (Maximum cable length: 50m (164 ft))

*: Use shielded cable in accordance with local rules for remote controller cable.

Select a flexible cable that can be bound using cable ties from over the cable sheath inside this unit.

Maximum connectable number of remote controllers by cable size and the length.

Cable size		Max. connectable number of remote controllers					
AWG	mm ²	L* ≤ 100 m		100 m < L* ≤ 250 m		250 m < L* ≤ 500 m	
		VRF	RAC	VRF	RAC	VRF	RAC
16	1.25	4	2	4	2	4	2
18	0.75 (1.25 > S* ≥ 0.75)	4	2	4	2	2	2
20	0.5 (0.75 > S* ≥ 0.5)	4	2	2	2	2	2
22	0.3 (0.5 > S* ≥ 0.3)	4	2	1	1	1	1

*L: Total cable length, *S: Cable size

4. SELECTING AN INSTALLATION LOCATION

4.1. Dimensions

This product is comprised of a body and cover.

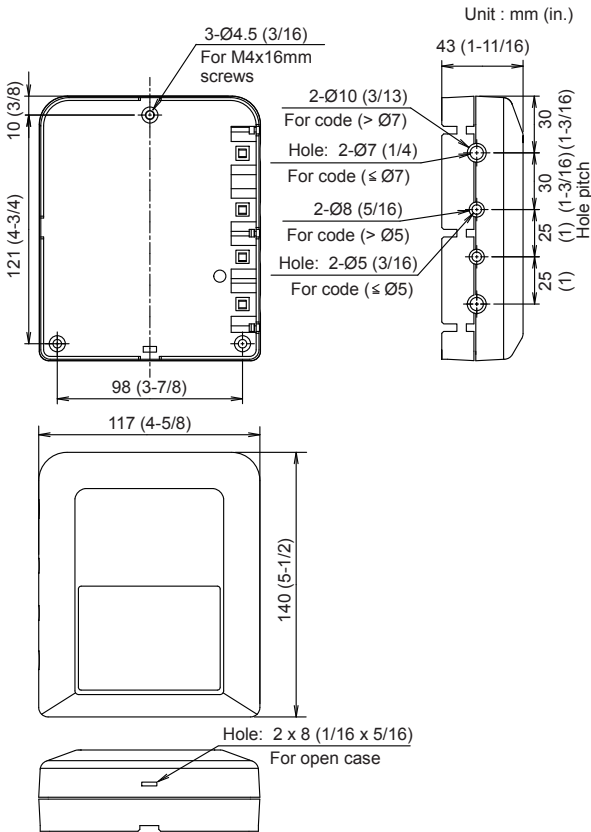

4.2. Specifications

Power consumption (W)		0.6
Temperature °C (°F)	Operating	0-46 (32-114)
	Packaged	-10-60 (14-140)
Humidity (%)	Packaged	0-95 (RH); No condensation
Dimensions H x W x D mm (in.)		43 x 117 x 140 (1-11/16 x 4-5/8 x 5-1/2)
Weight g (oz.)		250 (9)

5. WIRING

⚠ WARNING

Before starting installation work, turn off the power of this unit and the connection destination. Do not turn on the power again until installation is completed. Otherwise, it will cause electric shock or fire.

Use the accessories or specified connection cable. Do not modify power supply cable and connection cables other than those specified, do not use extension cables, and do not use independent branch wiring. It may cause electric shock or fire.

Install the connection cables securely to the terminal block. Confirm that external force is not applied to the cable. Use connection cables made of the specified cable. If intermediate connection or insertion fixing are imperfect, it will cause electric shock, fire, etc.

When connecting the connection cable, route the cables so that the cover of this unit is securely fixed. If the cover is imperfectly fixed, it may cause fire or overheating of the terminals.

Perform earth (ground) work positively. Do not connect the earth (ground) cable to a telephone cable, water pipe, or conductor rod.

Always fasten the outside covering of the connection cables with the cable clamp. (If the insulator is chafed, electric leakage may occur.)

Perform all wiring works so that the user does not touch the wiring. Doing so will cause injury or electric shock.

If any cable is damaged, do not repair or modify it yourself. Improper work will cause electric shock or fire.

⚠ CAUTION

Do not bind the remote controller cable and the external input cable together with or parallel to the power supply cable of the indoor and outdoor units. It may cause erroneous operation.

When performing wiring work, be careful not to damage the cable or injure yourself. Also, connect the connectors securely. Loose connectors will cause trouble, heating, fire, or electric shock.

Install the indoor and outdoor units, power supply cable, connection cable and remote controller cable 1 m (40 in.) away from television and radio to avoid distorted images and noise. Otherwise, a malfunction could result.

Perform wiring so that water does not enter this unit along the external wiring. Always install a trap to the wiring or take other countermeasures. Otherwise it will cause trouble or electric shock or fire.

Confirm the name of each unit and name of each terminal block of the unit and connect the wiring in accordance with the directions given in the manual so that there is no incorrect wiring. Incorrect wiring will damage the electric parts and cause smoke and fire.

When installing the connection cables near a source of electromagnetic waves, use shielded cable. Otherwise, a breakdown or malfunction could result.

The terminal screws and earth (ground) screws have different shapes. Be sure to install the screws in the correct locations. If the screws are installed in the wrong locations, the circuit board could be damaged.

5.1. Wiring method

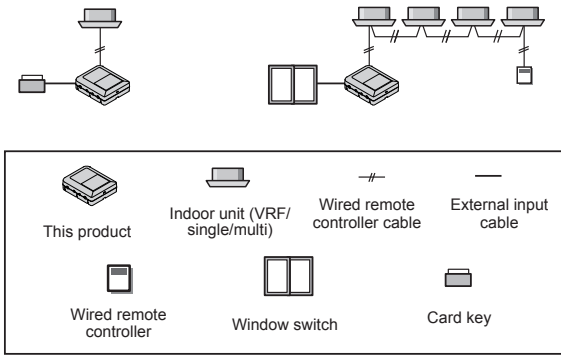

Connectable types of indoor unit and remote controller

The wired remote controller shown in the table below can be connected. The indoor unit that can be connected is the indoor unit that can connect to following remote controller.

Model name	RC number	Type
UTY-R*R*	AR-WEC** AR-WFA** AR-WFB** AR-WFC** AR-WFD** AR-WGA** AR-WGB**	Non-polar 2 wire
UTB- *UD	AR-6TC**	Polar 3 wire
UTY-R*N**	AR-WAE** AR-WAF** AR-WBE** AR-WBF** AR-WDC** AR-WDD**	Polar 3 wire
UTY-R*K*	AR-WAA** AR-WAC** AR-WBA** AR-WBB** AR-WBC** AR-WBD** AR-WBE** AR-WBF**	Polar 3 wire
UTB- *UB	AR-3TA**	Polar 3 wire
UTB- *PB	AR-3SA**	Polar 3 wire
UTB- *RA	AR-3SA**	Polar 3 wire

(* arbitrary character)

[Example of connecting single split type indoor unit in a parallel arrangement]

Case 1: For non-polar 2 wire

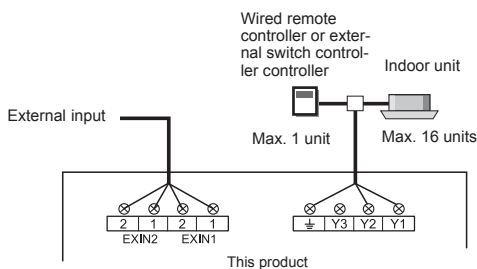

Case 2: For polar 3 wire

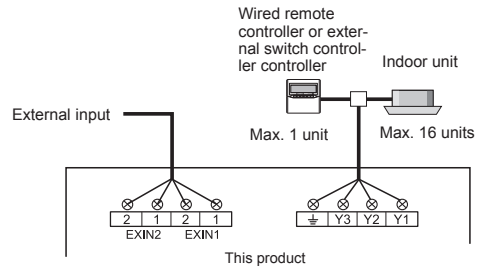

- Up to 16 indoor units may be controlled with a single external switch controller, however multiple indoor units connected to the external switch controller are generally required to have the same operation setting.
- Two or more types of VRF1 system, VRF2 system, single model or multi systems cannot be mixed together.

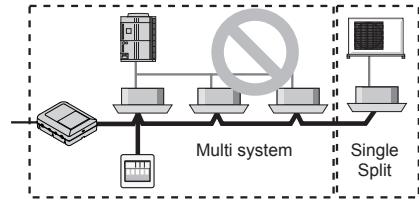

5.2. Unit wiring

5.2.1 External input cable and Remote controller cable

Remote controller cable

For 2-wire type

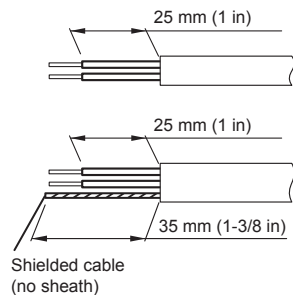

For 3-wire type

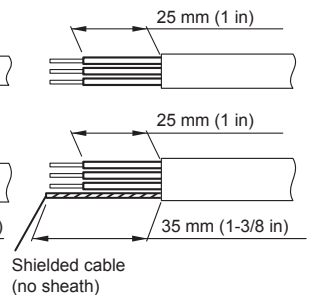

External input cable

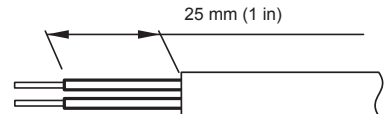

WARNING

Tighten the terminal screws to the specified torques, otherwise, abnormal overheating may be occurred and possibly cause heavy damage inside the unit.

Tightening torque

M3 screw (Remote controller / Y1, Y2, Y3) (External input / EXIN1, EXIN2)	0.5 to 0.6 N·m (4.4 to 5.3 lbf·in) (5 to 6 kgf·cm)
---	--

⚠ CAUTION

To peel the sheath from the lead cable, use a dedicated tool that will not damage the conductor cable.

When installing a screw on the terminal block, do not cut the cable by overtightening the screw. On the other hand, an under tightened screw can cause faulty contact, which will lead to a communication failure.

6. INSTALLING THE EXTERNAL SWITCH CONTROLLER

⚠ WARNING

Always use the accessories and specified installation work parts. Check the state of the installation parts. Not using the specified parts will cause units to fall off, electric shock, fire, etc.

Install at a place that can withstand the weight of the unit and install positively so that the unit will not topple or fall.

When installing this unit, make sure that there are no children nearby. Otherwise, injury or electric shock could result.

⚠ CAUTION

Do not set the DIP switch or rotary switch of this unit except as specified in this installation manual or the instruction manual supplied with the air conditioner. Setting the switches other than specified will cause an accident or trouble.

Use an insulated screwdriver to set the DIP switches.

Before opening the cover of this unit, completely discharge static electricity charged on your body. Otherwise, failure or malfunction could result.

Do not touch the circuit board and circuit board parts directly with your hands. Otherwise, injury or electric shock could result.

Tightening the mounting screws too tight will damage the body of this unit.

6.1. Connecting the cables

- (1) Turn off the power of the connecting unit.
- (2) Insert a screwdriver, etc., into the hole (For open case) and open the top cover.

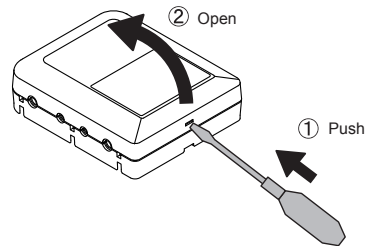

- (3) Connect the external input cable and remote controller cable to their respective terminal block properly.
- (4) Securely tighten the cable tie and then confirm that the cable will not come out.
- (5) Use the 3 screws (M4 × 16 mm) provided to mount this product to the behind ceiling, wall, floor or other suitable location.
- (6) Once the wiring of the cables is completed, snap in the 2 hooks on the top cover and close the top cover.

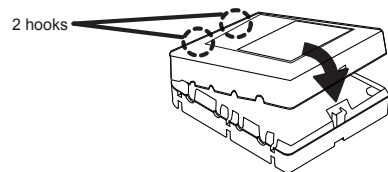

- (7) This product has seven holes as shown below. Putty up unused holes, as needed.

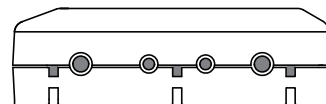

If a cable or cable tie goes through the hole, fill out the gap with the putty.

* The hole for a cable can be widened as necessary. When passing the thick cable through the hole, widen it.

Case 1: For non-polar 2 wire

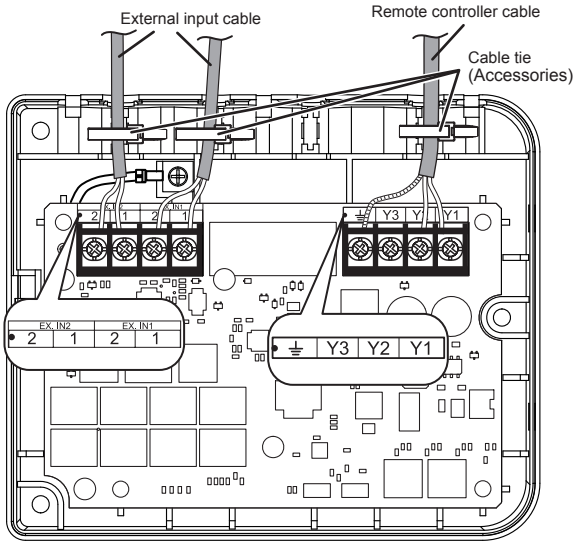

Case 2: For polar 3 wire

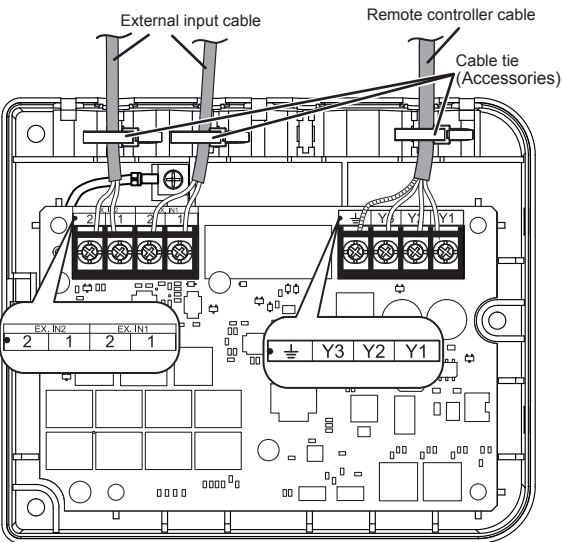

Fix the connector cable even outside the main unit as necessary.
Fix the cable with cable tie using 3 fixing holes.

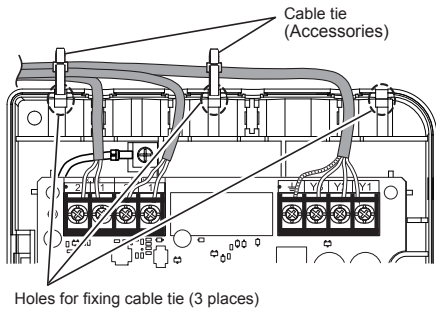

7. CONNECTION OF REMOTE CONTROLLER CABLE

CAUTION

When connecting the remote controller cable to the indoor unit, do not connect it to the outdoor unit or the power terminal block. It may cause a failure.

When connecting Indoor unit and external switch controller with the Remote controller cable, the following items should be considered.

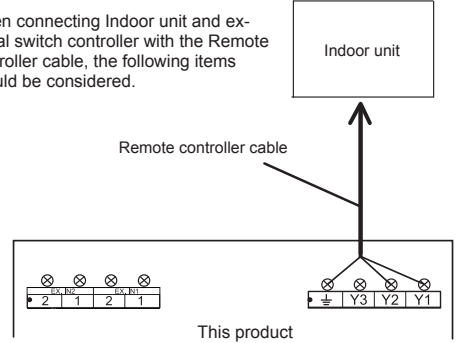

There are 2 methods to connect the remote controller cable to the indoor unit. One is the connection using contained connecting cable, and the other is the connection the remote controller cable is connected to the exclusive terminal block of the indoor unit. Exclusive terminal block for remote controller connection method is different depending on each model. Modify the remote controller cable as per below description and connect it. (For the details, refer to the installation manual of the indoor unit to be used.)

(1) When connecting to the connector

Case 1: For non-polar 2 wire

Use a tool to cut off the terminal on the end of the remote controller cable, and then remove the insulation from the cut end of the cable as shown in Fig. 1. Connect the remote controller cable and connecting cable as shown in Fig. 2. Be sure to insulate the connection between the cables.

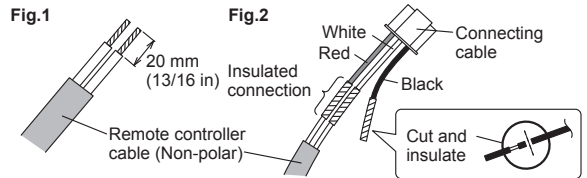

Connect the remote controller cable to the connecting cable, and insert it to the connector. Set to "2WIRE" the DIP switch (SW1) on the PC board of the indoor unit.

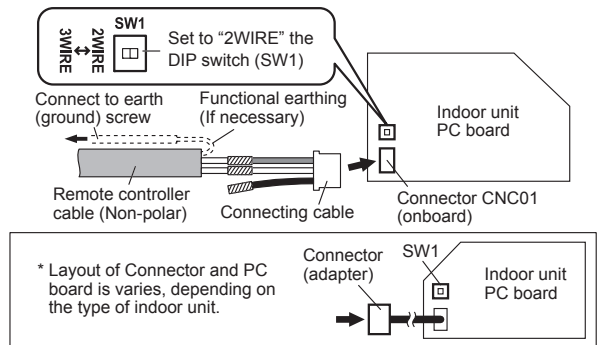

* Layout of Connector and PC board is varies, depending on the type of indoor unit.

Case 2: For polar 3 wire

Modify the cable as per below methods.

Use a tool to cut off the terminal on the end of the remote controller cable, and then remove the insulation from the cut end of the cable as shown in Fig. 1.

Connect the remote controller cable and connecting cable as shown in Fig. 2.

Be sure to insulate the connection between the cables.

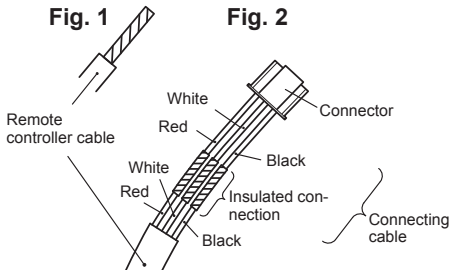

Connect the remote controller cable to the connecting cable, and insert it to the connector.

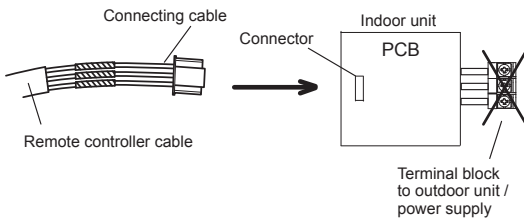

When the board has the 2WIRE/3WIRE DIP switch on it, set it to 3WIRE.

For how to set, see "Case 1: For non-polar 2 wire".

(2) When connecting to the exclusive terminal block

Connect the end of remote controller cable directly to the exclusive terminal block.

If there is the 2WIRE/3WIRE switch on the PC board of the indoor unit, set it to match the connection method of the connected remote controller cable.

Example) Connection of non-polar 2 wire

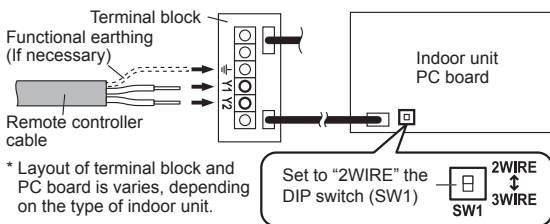

* Layout of terminal block and PC board is varies, depending on the type of indoor unit.

8. CONNECTION OF EXTERNAL INPUT CABLE

When the switch is connected.

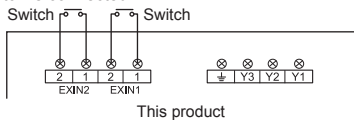

Select low current use contacts (usable at DC5V, DC2mA or less).

Short circuit detection resistance (R ON): $\leq 500 (\Omega)$.
Open circuit detection resistance (R OFF): $\geq 100 (k\Omega)$.
A twister pair cable $0.33\sim 1.25 \text{ mm}^2$ (16~22AWG) should be use.
Maximum length of cable is 50m (164 ft).

9. CIRCUIT BOARD SETTING

The circuit board has a rotary switch, DIP switch and LED as shown below.

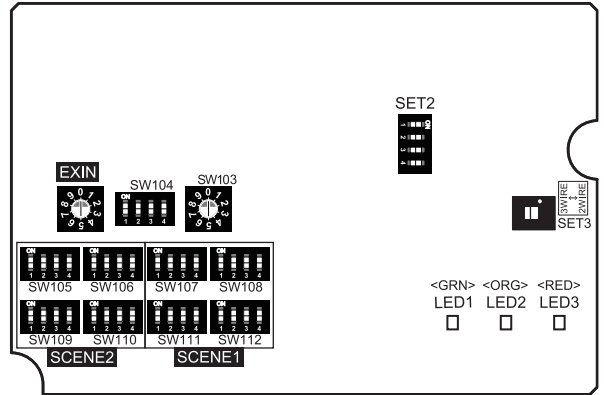

(1) About connections

(1-1) 2WIRE/3WIRE settings (SET3)

Remote controller 2WIRE/3WIRE switching SW
"Default: 2WIRE"

Set matched with the connection method of the remote controller cable to be connected.

(1-2) Master settings (SET 2-1 When setting the SET3 to 3WIRE)

DIP SW	OFF ★	ON
SET 2-1	Master	Slave

(★: Factory setting)

Enabled only when setting the SET3 to 3WIRE

Set when using with a remote controller or other external switch controller. When using with a remote controller, set the remote controller to "Master" and the external switch controller to "Slave".

When using two external switch controllers, set one to "Master" and the other one to "Slave."

(1-3) Response speed setting (SET 2-2)

DIP SW	OFF ★	ON
SET 2-2	Instant (200ms)	Delay (1min)

(★: Factory setting)

Set the time for the signal to be output from the controller after changing the external switch.

(2) About external switch controller operating prohibition

(2-1) Remote controller prohibition setting (SET 2-3)

DIP SW	OFF ★	ON
SET 2-3	Remote controller prohibition ineffective	Remote controller prohibition effective

(★: Factory setting)

If there is a prohibition from the central control unit, this setting determines whether or not there is a prohibition for the external switch controller operation.

(2-2) Operation condition setting (SET 2-4)

DIP SW	OFF ★	ON
SET 2-4	Unconditional	When indoor unit operating only

(★: Factory setting)

Determines whether or not operation of the indoor unit is set as an operation condition for the external switch controller.

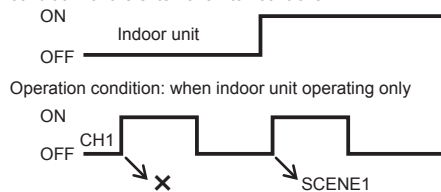

Output from "Remote controller prohibition all operation" is generated regardless the operation condition setting.

(3) About air conditioner output setting

Setting	SW	Reference Section
Mode setting	SW104-1	See (3-1)
External switch detection conditions with Mode 0	SW104-3/4	See (3-2) ①
Output setting with Mode 0	Rotary SW (EXIN)	See (3-2) ②
External switch detection conditions with Mode 1	SW104-3/4	See (3-3) ①
Output setting with Mode 1	Rotary SW (EXIN)	See (3-3) ②
OFF output setting	SW104-2	See (3-4)

(3-1) Mode setting (SW104-1)

DIP SW	OFF ★	ON
SW104-1	Mode 0	Mode 1

(★: Factory setting)

Determines how "SCENE setting" is assigned.

Mode 0: Assign 2 scenes to 2 switches.

Mode 1: Assign 4 scenes to 2 switches.

Mode 0

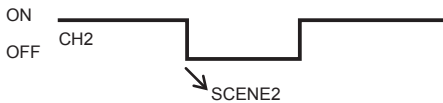

Mode 1

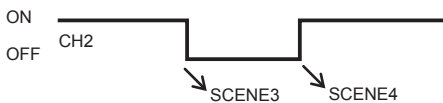
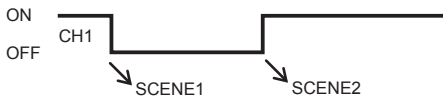

(3-2) For Mode 0 (SW104-1)

① Polarity setting (SW104-3/4)

DIP SW	Setting	OFF ★	ON
SW104-3	CH1 external switch detection condition	ON→OFF	OFF→ON
SW104-4	CH2 external switch detection condition	ON→OFF	OFF→ON

(★: Factory setting)

SW104-3 and SW104-4 sets the polarity of CH1 and CH2 respectively.

SW104-3: OFF



SW104-3: ON



② Rotary switch setting (EXIN)

Rotary switch setting value	Setting
0 ★	No output
1	Operation stop output
2-9	Forbidden

(★: Factory setting)

When set to 0, there will be no output on the side (ON or OFF) opposite to which SCENE 1 or SCENE 2 is assigned.

When set to 1, Operation stop is outputted on the side (ON or OFF) opposite to which SCENE 1 or SCENE 2 is assigned.

EXIN Rotary switch: 0

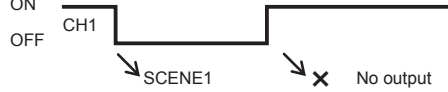

EXIN Rotary switch: 1



(3-3) For Mode 1 (SW104-1)

① Polarity setting (SW104-3/4)

DIP SW	Setting	OFF ★	ON
SW104-3	No function	Fixed to OFF	—
SW104-4	CH2 external switch detection condition	ON → OFF is SCENE3 OFF → ON is SCENE4	OFF → ON is SCENE3 ON → OFF is SCENE4

(★: Factory setting)

② Rotary switch setting (EXIN)

Rotary switch setting value	Setting	SCENE3	SCENE4
0 ★	Operation stop	Operation	Stop
1	Remote controller prohibition all operation	All operation enabled	All operation disabled
2*	Operation mode	COOL	HEAT
3-9	Forbidden		

(★: Factory setting)

* For VRF heat pump models, the operation mode cannot be switched between COOL/HEAT when the indoor unit operation is ON.

Refer to (3-4)

Set CH2.

SW104-3 has no function.

SW104-4 determines SCENE3 and SCENE4 assigned to the function selected with Rotary switch (EXIN).

SW104-4: OFF



SW104-4: ON

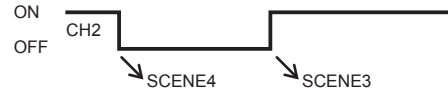

Rotary switch (EXIN) selects the function assigned to CH2.

(3-4) OFF output setting (SW104-2)

For VRF heat pump models, the operation mode cannot be switched between COOL/HEAT when the indoor unit operation is ON. In this case, operation can be switched between COOL/HEAT by setting OFF output to "Enabled," turning operation of the indoor unit to OFF and then changing the operation mode.

DIP SW	OFF ★	ON
SW104-2	Disabled	Enabled

(★: Factory setting)

Determines whether or not there is operation stop output before the output set with the external input switch.

When this is set to "Enabled," if the external switch changes, there is an operation stop output, and then the set air-conditioner operation setting is output 1 minute later.

OFF output enabled



(4) About SCENE setting

Operation (operation stop, fan speed, operation mode, remote controller prohibition all operation, set temperature) of the air conditioner output with "SCENE1" and "SCENE2" can be set. Multiple settings included with each "SCENE" can also be changed simultaneously.

Setting	SW	Reference Section
SCENE 1 setting	SW107, 108, 111, 112	See (4-1)
SCENE 2 setting	SW105, 106, 109, 110	See (4-1)

(4-1) SCENE1/2 setting (SW105~SW112)

This product can be set individually for the 2 types of SCENES. SCENE1 is set with SW107/108/111/112, and SCENE2 is set with SW105/106/109/110.

- Operation stop [SW107-1/2(SCENE1), SW105-1/2(SCENE2)]

Setting	SW107-1	SW107-2	SW105-1	SW105-2
No change ★	OFF	OFF	OFF	OFF
Stop	ON	OFF	ON	OFF
Operation	OFF	ON	OFF	ON
SETBACK *1	ON	ON	ON	ON

(★: Factory setting)

*1 Setting of SETBACK turns back the operation state to that of before switching parameter setting.

When SETBACK is set to ON, the Operation Mode, Fan Speed, and Set Temperature settings become ineffective. "Remote controller prohibition all operation" is also ignored.

To make them effective, set SETBACK to OFF.

- Restore the operation setting of the air conditioner set with "SCENE setting." This product can be set even with remote controller prohibition all operation, so this setting is also restored. If operation stop is set to SETBACK, settings other than operation stop for the same scene will be ignored.

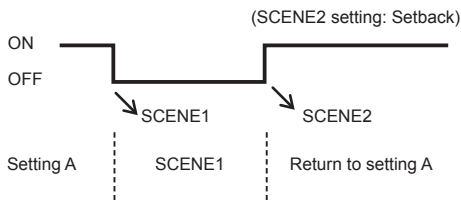

- Fan speed [SW107-3/4(SCENE1), SW105-3/4(SCENE2)]

Setting	SW107-3	SW107-4	SW105-3	SW105-4
No change ★	OFF	OFF	OFF	OFF
Hi	ON	OFF	ON	OFF
Med	OFF	ON	OFF	ON
Lo	ON	ON	ON	ON

(★: Factory setting)

- Operation mode

[SW108-1/2(SCENE1), SW106-1/2(SCENE2)]

Setting	SW108-1	SW108-2	SW106-1	SW106-2
No change 1 ★	OFF	OFF	OFF	OFF
COOL*2	ON	OFF	ON	OFF
HEAT*2	OFF	ON	OFF	ON
No change 2 *3	ON	ON	ON	ON

(★: Factory setting)

*2 For VRF heat pump models, the operation mode cannot be switched between COOL/HEAT when the indoor unit operation is ON.

Refer to (3-4)

*3 If operation mode is set to "No change 2" the operation mode is not changed.

If this scene is run,

- (1) If operation mode is "COOL or DRY," the set temperature will be changed to "set temperature 1."
- (2) If operation mode is "HEAT," the set temperature will be changed to "set temperature 2."
- (3) If operation mode is "AUTO or fan," the set temperature is not changed.

- Remote controller prohibition all operation [SW108-3/4(SCENE1), SW106-3/4(SCENE2)]

Setting	SW108-3	SW108-4	SW106-3	SW106-4
No change ★	OFF	OFF	OFF	OFF
Disabled	ON	OFF	ON	OFF
Enabled	OFF	ON	OFF	ON
Forbidden	ON	ON	ON	ON

(★: Factory setting)

If "Remote controller prohibition effective" is set, the "Remote controller prohibition all operation" setting cannot be set from this product.

With a polar 3 core connection, the "Remote controller prohibition all operation" setting cannot be set.

- Set temperature 1 [SW111-1/2/3/4(SCENE1), SW109-1/2/3/4(SCENE2)]
- Set temperature 2 [SW112-1/2/3/4(SCENE1), SW110-1/2/3/4(SCENE2)]

Setting	SW111-1/ SW109-1, SW112-1/ SW110-1	SW111-2/ SW109-2, SW112-2/ SW110-2	SW111-3/ SW109-3, SW112-3/ SW110-3	SW111-4/ SW109-4, SW112-4/ SW110-4
No change ★	OFF	OFF	OFF	OFF
16°C (60°F) *4 *5	ON	OFF	OFF	OFF
17°C (62°F) *4 *5	OFF	ON	OFF	OFF
18°C (64°F)	ON	ON	OFF	OFF
19°C (66°F)	OFF	OFF	ON	OFF
20°C (68°F)	ON	OFF	ON	OFF
21°C (70°F)	OFF	ON	ON	OFF
22°C (72°F)	ON	ON	ON	OFF
23°C (74°F)	OFF	OFF	OFF	ON
24°C (76°F)	ON	OFF	OFF	ON
25°C (78°F)	OFF	ON	OFF	ON
26°C (80°F)	ON	ON	OFF	ON
27°C (82°F)	OFF	OFF	ON	ON
28°C (84°F)	ON	OFF	ON	ON
29°C (86°F)	OFF	ON	ON	ON
30°C (88°F)	ON	ON	ON	ON

(★: Factory setting)

*4 Do not set the operation mode "HEAT," or the setting temperature "16°C (60°F)" or "17°C (62°F)" for COOLING ONLY MODEL. These settings do not function.

*5 Units cannot operate correctly under the settings shown below:

- Set the operation mode to "HEAT" and temperature to "16°C (60°F)" or "17°C (62°F)" during operation in Cooling priority.

- Set the operation mode to "COOL" during operation in Heating priority.
- Set the Fan speed during the operation mode "DRY".

"Set temperature 2" can only be used with "No change 2."

"Set temperature 1" is normally used, and "Set temperature 2" is applied when the operation mode is "No change 2."

(5) About OFF TIMER setting

OFF TIMER specifications are as follows.

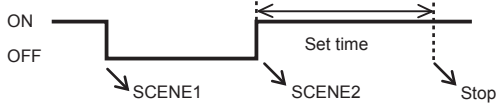

Rotary switch setting (SW103)

Rotary switch setting value	Set time
0 ★	Do not turn Stop
1	Stop after 1 hour *5
2	Stop after 3 hours
3	Stop after 6 hours
4	Stop after 12 hours
5	Stop after 24 hours
6~9	Forbidden

(★: Factory setting)

*5 When the operation mode is set to "No change 2" and the operation mode of the indoor unit is "HEAT," it will turn Stop after 2 hours.

When Rotary switch (SW103) is set to 1~5 and Mode setting (SW104-1) is Mode 1 (ON), the polarity setting (SW104-3) is set as follows.

DIP SW	Setting	OFF	ON
SW104-3	CH1 external switch detection condition	ON → OFF is SCENE1 OFF → ON is SCENE2	ON → OFF is SCENE2 OFF → ON is SCENE1

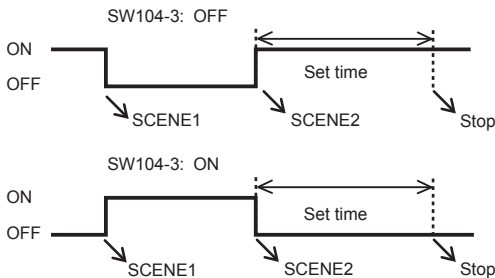

10. ABOUT SWITCH SETTING

To set multiple settings to the same switch, switch combinations are listed at the bottom of the next page. Write down switch setting examples before use.

11. EXAMPLE SETTING

(1) Example setting 1

- Insert card key and set to COOL, temperature 23°C, Fan speed: Hi, remove card key and set to COOL, temperature 30°C, Fan speed: Lo.

(For specifications where inserting the card key turns the contact ON, and removing it turns the contact OFF)

Use the unit by connecting the card key to CH1, and nothing to CH2.

Setting	SW No.	SW setting	Function
Mode	SW104-1	ON	Mode1
OFF output	SW104-2	OFF	Disabled
Polarity	SW104-3	OFF	No function
	SW104-4	OFF	ON → OFF SCENE3 OFF → ON SCENE4
CH2 setting	EXIN	0	Operation stop

SCENE	Setting	SW No.	SW setting	Function
SCENE1	Operation stop	SW107-1/2	OFF/OFF	No change
	Fan speed	SW107-3/4	ON/ON	Lo
	Operation mode	SW108-1/2	ON/OFF	COOL
	All operation	SW108-3/4	OFF/OFF	No change
	Set temperature 1	SW111-1/2/3/4	ON/ON/ ON/ON	30°C (88°F)
	Set temperature 2	SW112-1/2/3/4	OFF/OFF/ OFF/OFF	No change
SCENE2	Operation stop	SW105-1/2	OFF/OFF	No change
	Fan speed	SW105-3/4	ON/OFF	Hi
	Operation mode	SW106-1/2	ON/OFF	COOL
	All operation	SW106-3/4	OFF/OFF	No change
	Set temperature 1	SW109-1/2/3/4	OFF/OFF/ OFF/ON	23°C (74°F)
	Set temperature 2	SW110-1/2/3/4	OFF/OFF/ OFF/OFF	No change

(2) Example setting 2

- When a window is opened, operation stop + remote controller operation prohibited, return to original state when the window is closed.

(For specifications where contact OFF when the window is opened, and contact ON when the window is closed)

Use the unit by connecting the window switch to CH1, and nothing to CH2.

* Only possible when non-polar 2 core remote controller is connected, with remote controller prohibition set to "Ineffective".

Setting	SW No.	SW setting	Function
Mode	SW104-1	ON	Mode1
OFF output	SW104-2	OFF	Disabled
Polarity	SW104-3	OFF	No function
	SW104-4	OFF	ON → OFF SCENE3 OFF → ON SCENE4
CH2 setting	EXIN	0	Operation stop

SCENE	Setting	SW No.	SW setting	Function
SCENE1	Operation stop	SW107-1/2	ON/OFF	Stop
	Fan speed	SW107-3/4	OFF/OFF	No change
	Operation mode	SW108-1/2	OFF/OFF	No change
	All operation	SW108-3/4	OFF/ON	Enabled
	Set temperature 1	SW111-1/2/3/4	OFF/OFF/ OFF/OFF	No change
	Set temperature 2	SW112-1/2/3/4	OFF/OFF/ OFF/OFF	No change
SCENE2	Operation stop	SW105-1/2	ON/ON	SETBACK
	Fan speed	SW105-3/4	OFF/OFF	No change
	Operation mode	SW106-1/2	OFF/OFF	No change
	All operation	SW106-3/4	OFF/OFF	No change
	Set temperature 1	SW109-1/2/3/4	OFF/OFF/ OFF/OFF	No change
	Set temperature 2	SW110-1/2/3/4	OFF/OFF/ OFF/OFF	No change

(3) Example setting 3

- When inserting card key
If the indoor unit operation mode is COOL, operation ON, set temperature 26°C (80°F)
If the indoor unit operation mode is HEAT, operation ON, set temperature 20°C (68°F)
- Removing the card key
If the indoor unit operation mode is COOL, set temperature 30°C (88°F)
If the indoor unit operation mode is HEAT, set temperature 16°C (60°F)
Then set operation stop after 3 hours

When connecting the card key to CH1, and nothing to CH2

Inserting the card key makes the contact ON, and removing it makes it OFF

Setting	SW No.	SW setting	Function
Mode	SW104-1	ON	Mode1
OFF output	SW104-2	OFF	Disabled
Polarity	SW104-3	ON	OFF→ON SCENE1 ON→OFF SCENE2
	SW104-4	OFF	ON→OFF SCENE3 OFF→ON SCENE4
CH2 setting	EXIN	0	Operation stop
OFF TIMER	SW103	2	Stop after 3 hours

SCENE	Setting	SW No.	SW setting	Function
SCENE1	Operation stop	SW107-1/2	OFF/ON	Operation
	Fan speed	SW107-3/4	OFF/OFF	No change
	Operation mode	SW108-1/2	ON/ON	No change 2
	All operation	SW108-3/4	OFF/OFF	No change
	Set temperature 1	SW111-1/2/3/4	ON/ON/ OFF/ON	26°C (80°F)
	Set temperature 2	SW112-1/2/3/4	ON/OFF/ ON/OFF	20°C (68°F)
SCENE2	Operation stop	SW105-1/2	OFF/OFF	No change
	Fan speed	SW105-3/4	OFF/OFF	No change
	Operation mode	SW106-1/2	ON/ON	No change 2
	All operation	SW106-3/4	OFF/OFF	No change
	Set temperature 1	SW109-1/2/3/4	ON/ON/ ON/ON	30°C (88°F)
	Set temperature 2	SW110-1/2/3/4	ON/OFF/ OFF/OFF	16°C (60°F)

12. TURNING ON THE POWER

- Check this product wiring and switch settings on the circuit board.
- Check the wiring and switch settings for the VRF system or multi system or single model. For the wiring and switch settings method, refer to the installation instruction sheet of each unit.
- Turn on the power for the VRF system or multi system or single model.
- Power will be supplied from the system to the converter.
 - This product will be initialized and the power turned on. LED1 (green) and LED2 (orange) will flash.
 - After initial setting is completed, operation will be restarted automatically. LED1 (green) lights.
 - This product does not operate during initialization.
 - * An error code will appear on LED in the event of a malfunction.

13. LED DISPLAY

13.1. Normal code

Normal indications			Normal contents
LED1 (green)	LED2 (orange)	LED3 (red)	
●	●	□	During initialization (during initialization sequence)
■	□	□	Normally operating

Display mode ■ : On
□ : Off
● : Flashing

13.2. Error code

When error occurs in the remote controller connected to the Network converter, please refer to the installation manual of the remote controller and indoor unit.

Error indications			Error contents
LED1 (green)	LED2 (orange)	LED3 (red)	
● (1)	● (2)	◇	Remote controller communication error
● (1)	● (5)	◇	Scan error
● (2)	● (6)	◇	Indoor unit address setting error
● (11)	● (2)	◇	Peripheral unit transmission PCB error

Display mode ● : 0.5s ON / 0.5s OFF
◇ : 0.1s ON / 0.1s OFF
() : Number of flashing

• Switch location map

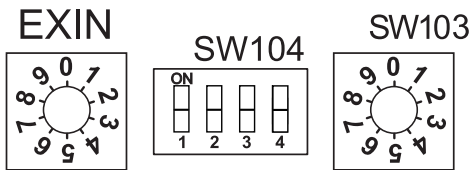

SET2

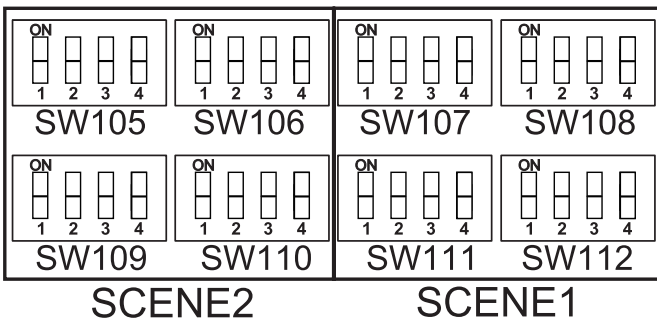
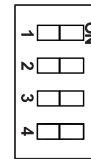

FUJITSU GENERAL LIMITED

3-3-17, Suenaga, Takatsu-ku, Kawasaki 213-8502, Japan