

ADDENDUM

001

March 2016

LonWorks Airstage Communication Cable Changes

To help eliminate Airstage communication wiring installation issues, Fujitsu is standardizing on a specific model of LonWorks cable that can be used on all Airstage VRF installations. Fujitsu will be providing the cable as an Airstage Part. Currently, the cable is available in 250 Ft and 500 Ft spool/reel sizes. This LonWorks cable shall be the **ONLY APPROVED LONWORKS CABLE** to be used on any Airstage system installation. The approval of the Extended Warranty shall be contingent on the use of this cable.

The Airstage Parts for the Fujitsu LonWorks cables are the following:

Cable Type	Pairs	Details	Catalog Number
Level 4 NEMA 22AWG	1	250ft LonWorks Shielded cable	K00250LW
	1	500ft LonWorks Shielded cable	K00500LW

This addendum information shall supersede any LonWorks cable requirements listed in any of the Airstage Design & Technical Manuals or Installation Manuals.

Design & Technical Manual for Airstage V-II 208/230V, 60Hz
Design & Technical Manual for Airstage V-II 460V, 60Hz
Design & Technical Manual for Airstage VR-II 208/230V, 60Hz
Design & Technical Manual for Airstage VR-II 460V, 60Hz
Design & Technical Manual for Airstage J-II 208/230V, 60Hz
Design & Technical Manual for Outdoor Air Unit 208/230V, 60Hz

Fujitsu Airstage VRF system wiring detail:

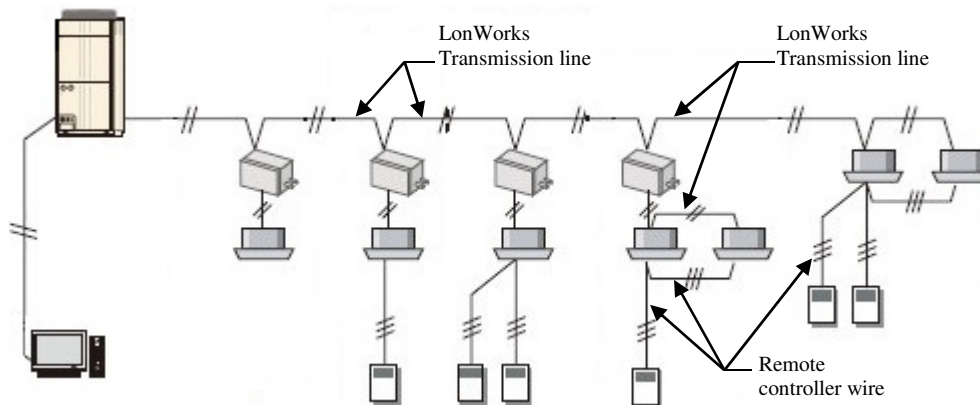



SERVICE MANUAL

AIRSTAGE™ V-II

Variable Refrigerant Flow System

Multi Air Conditioning System for Buildings

Large Capacity Multi VRF System

DC Inverter Control Compressor

Long Piping System Design

High Efficiency Refrigerant R410A



208/230V 60Hz

FUJITSU GENERAL LIMITED

CONTENTS

1. TEST RUN

1-1 EXECUTION PROCEDURE AND EXECUTION PRECAUTIONS	01-01
1-2 TEST RUN METHOD	01-03
1-2-1 Check Items Before Power ON.....	01-03
1-2-2 Check Items After Power ON.....	01-04
1-2-3 Test Run From Outdoor PC Board.....	01-06
1-2-4 Test Run From Remote Controller.....	01-07
1-3 TEST RUN CONTROL	01-11
1-4 Field Setting And Monitor Mode List for Outdoor unit	01-12
1-5 Field Setting / Function setting for Indoor unit	01-15
1-6 Field Setting / Function setting for Outdoor air unit	01-16

2. OUTDOOR UNIT OPERATION CONTROL

2-1 INPUT / OUTPUT LIST	02-01
2-2 COMPRESSOR OPERATION	02-02
2-2-1 Operation / Stop Condition.....	02-02
2-2-2 Capacity Control.....	02-02
2-2-3 Speed Range of Start,Stop,And Operation.....	02-03
(For DC Inverter Rotary Compressor)	
2-2-4 Compressor Sequence Operation.....	02-05
2-3 FAN CONTROL	02-06
2-3-1 Cooling Operation.....	02-06
2-3-2 Heating Operation.....	02-07
2-3-3 Low noise mode.....	02-08
2-3-4 Snow Falling Protection Fan Mode.....	02-09
2-3-5 Other Control.....	02-09
2-4 EXPANSION VALVE CONTROL	02-09
2-5 SPECIAL OPERATION	02-10
2-5-1 Oil Recovery Operation.....	02-10
2-5-2 Pre-Heat Operation.....	02-11
2-5-3 Defrost Operation Control.....	02-11
2-6 PROTECTIVE FUNCTION	02-13
2-6-1 Protective Function List.....	02-13

CONTENTS

3. INDOOR UNIT OPERATION CONTROL

3-1 FAN CONTROL	03-01
3-1-1 Fan Speed Setting.....	03-01
3-1-2 "AUTO" Position.....	03-01
3-2 MASTER CONTROL	03-02
3-2-1 Operation Mode Control.....	03-02
3-2-2 Auto Changeover.....	03-04
3-2-3 "COOL" Position.....	03-05
3-2-4 "HEAT" Position.....	03-05
3-3 LOUVER CONTROL	03-06
3-4 ELECTRONIC EXPANSION VALVE CONTROL	03-09
3-5 DRAIN PUMP OPERATION	03-09
3-6 FUNCTION	03-10
3-6-1 Auto Restart.....	03-10
3-6-2 Icing Protection Control.....	03-10
3-6-3 Oil Recovery Operation.....	03-10
3-7 TIMER CONTROL	03-11
3-7-1 Wireless Remote Controller.....	03-11
3-7-2 Wired Remote Controller.....	03-13

4. TROUBLE SHOOTING

4-1 NORMAL OPERATION	04-01
4-1-1 Indoor Unit Display.....	04-01
4-1-2 Outdoor Unit Display.....	04-02
4-2 ABNORMAL OPERATION	04-03
4-2-1 Indoor Unit Display.....	04-03
4-2-2 Outdoor Unit Display.....	04-04
4-2-3 Error Code List for Outdoor Unit.....	04-05
4-2-4 Remote Controller Display.....	04-06
4-2-5 Error Code List for Simple and Wired Remote Controller.....	04-07
4-2-6 Error Code List for Group Remote Controller.....	04-07
4-2-7 Trouble Level of System.....	04-08
4-2-8 Error History Mode.....	04-10
4-3 TROUBLE SHOOTING	04-11
4-3-1 Trouble Shooting With Error Code (INDOOR UNIT).....	04-11
4-3-2 Trouble Shooting With Error Code (OUTDOOR UNIT).....	04-22
4-3-3 Trouble Shooting for Optional Parts.....	04-70
4-4 SERVICE INFORMATION	04-84
4-4-1 Backup operation.....	04-84
4-4-2 Work procedure after the backup operation.....	04-86
4-5 SERVICE PARTS INFORMATION	04-87

CONTENTS

5. APPENDING DATA

5-1 REFRIGERANT CIRCUIT	05-01
5-2 WIRING DIAGRAM	05-03
5-2-1 Indoor Unit.....	05-03
5-2-2 Outdoor Unit.....	05-12
5-2-3 Outdoor Air Unit	05-12 ⁺¹
5-2-4 Vertical Air Handler.....	05-12 ⁺³
5-3 SATURATION TABLE (R410A)	05-13
5-3-1 Saturation Temperature and Saturation Pressure Table (°C / Mpa).....	05-13
5-3-2 Saturation Temperature and Saturation Pressure Table (°F / PSI).....	05-14
5-3-3 Temperature and pressure of refrigerant (Graph).....	05-15

6. DISASSEMBLY PROCESS



AIRSTAGE™ V-II

Variable Refrigerant Flow System

1. TEST RUN

1. TEST RUN

1-1 EXECUTION PROCEDURE AND EXECUTION PRECAUTIONS

Before execution

Execution procedure and precautions	Reason
Do not install the units in the place not recommended in the installation manual.	• The performance may drop significantly due to the protection function
Check the characteristics of the refrigerant used and verify the special features of the refrigerant. If refrigerant must be charged, always charge the refrigerant specified for the product. *Confirm the product design pressure. < R410A 609psi (4.20MPa) >	• Use of a refrigerant other than the specified refrigerant will invite equipment failure
Prepare the design for the system	
① Use new refrigerant piping of the thickness specified by the D&T manual. ② Since R410A dedicated tools are necessary, prepare them in advance. ③ Absolutely avoid use of existing piping. If use of existing piping is unavoidable, the piping must be cleaned.	• Secure the necessary pressure resistance.

Execution 1/2

Sleeve and insert work	Always use a level to keep the indoor unit level. If the equipment is tilted toward the drain port, install it so that the tilt is within 13/32 in(10mm). Excessive tilt will cause water leakage.	• Prevention of water leakage
Indoor unit installation	When performing piping work, observe the following items so that the inside of the piping is clean and air tight.	• Foreign matter, water, etc. in the piping will cause faulty cooling and compressor failure.
Refrigerant piping work	① Use pipe that is not dirty inside. ② Confirm the design for the piping (Diameter, Thickness) ③ When the pipe is left standing, protect it. ④ Confirm the angle of separation tube and header correctry. ⑤ Finish flaring.	• Incorrect pipe diameter will cause faulty cooling • Incorrect angle of separation tube or header will be cause poor cooling or refrigerant noise problem
Drain piping work	⑥ Confirm the width across flats dimension and shape of flare nuts. ⑦ Always blow nitrogen while brazing. ⑧ Perform flushing before connecting the equipment.	• Refrigerant leakage will cause low performance and abnormal stopping
Duct work	① Always make the downward slope of the drain pipe 1/100 or greater and make the horizontal length within 66ft.(20m). ② Use hard polyvinylchloride pipe as the drain pipe. ③ Support the drain pipe between 59-1/16 in(1.5m) to 6-3/4 in (2.0m). ④ Use pipe of 1 inch or bigger (VP30 or greater) as central piping.	• Prevention of water leakage
Heat insulation work	Select the size of the heat insulating material according to the ambient temperature and relative humidity of the refrigerant. Use a heat insulating material having a heat conductivity of 0.043W/(m·k) or less.	• Prevention of water leakage
Electrical work	When making flare connections always use a torque wrench and tighten the flare nut to the specified torque.	• Refrigerant leakage will cause low performance and abnormal stopping.
Outdoor unit foundation work	Pressurize the product with nitrogen gas up to the design pressure and conduct a 24Hr air tight test.	• Refrigerant leakage will cause low performance and abnormal stopping.
Outdoor unit installation	① Install a vacuum pump with reverse flow check mechanism or a reverse flow check adaptor to a conventional vacuum pump and use. Pump down to the required vaccum level. ② Approximately 1 hour or longer after 500 micron (-100.7kPa) reached. Allow to stand for approximately 1 hour after stopping the vacuum pump and confirm that the needle does not return. ③ Air purging using refrigerant is strictly prohibited.	• Mixing in of vacuum pump oil by reverse flow will cause equipment trouble. • Recommend the vacuuming mode
Refrigerant piping connection work		
Air tightness test		
Vacuum drying		

* Vacuuming mode

This function is used for vacuuming the indoor unit and the connection piping if power was turned ON before performing the required vacuuming procedure.

Note: For starting Vacuuming mode, the refrigerant address setting has to be finished.

When the [vacuuming mode] is set, <Push switch setting, F3:21> EEV of connected all indoor units opens.
So, the vacuuming indoor unit and piping becomes easier.

When the vacuuming ends, please turn off the power supply for all of the indoor units and outdoor unit, [vacuuming mode] is released.

Execution 2/2

Addition refrigerant charging	<ol style="list-style-type: none"> ① Confirm the additional refrigerant amount with the installation manual, etc. ② Always take the R410A refrigerant from the cylinder liquid phase. (Do not lay a cylinder with siphon pipe on its side.) ③ Use an R410A dedicated gauge manifold and charging hose. ④ Charge refrigerant using the liquid pipe. ⑤ When the defined amount of refrigerant cannot charge using the liquid pipe, charge refrigerant using the gas pipe while operating the cooling test run. Charge refrigerant bit by bit with cautious operation of valve for the liquid refrigerant back prevention. 	<ul style="list-style-type: none"> • If taken from the air phase, since the composition of the refrigerant which is charged will change, low performance and abnormal stop will occur easily. • Prevent wrong amount of refrigerant charge.
Gas leak test	Use an R410A dedicated leak tester to check for gas leaks.	• A leak tester for other than R410A cannot detect leaks.
Initial setting	<ol style="list-style-type: none"> ① Set the refrigerant circuit address. (ROTARY SW : REF AD × 10, ×1) Set the outdoor unit address. ② (DIP SW : SET3-1 / 3-2) ③ Number of slave units setting. (Master unit only) (DIP SW : SET3-3 / SET3-4) ④ Number of outdoor units setting. (DIP SW : SET5-1 / 5-2) 	<p>Arbitrary numbers can be set in range of 00-99</p> <p>OFF / OFF: Master unit OFF / ON : Slave unit 1 ON / OFF : Slave unit 2</p> <p>OFF / OFF: 0 units (Master unit only) OFF / ON : 1 unit (1 slave unit connected) ON / OFF : 2 units (2 slave unit connected)</p> <p>OFF / OFF: 1 (Master unit only) OFF / ON : 2 (1 master unit + 1 slave unit) ON / OFF : 3 (1 master unit + 2 slave units)</p>
Piping length setting	<p>Set according to the length of the connection piping. Set to "Standard 131ft to 213ft (40 to 65m)" at the factory. Set using the push button SW on the outdoor unit PC board. (See technical Manual System design)</p>	
Address setting	<p>Set the refrigerant circuit address and indoor unit address. Can be set by rotary SW on the indoor unit control PC board or from a remote controller or from a push button SW on the outdoor unit PC board (automatic address).</p>	
Test run & adjustment	<p>[Note] Set the rotary SW on the PC board while the power is OFF. Perform setting by remote controller and setting from push button SW on the outdoor unit PC board while the power is ON.</p>	
Turnover & explanation of operation		

1-2 TEST RUN METHOD

1-2-1 Check Items Before Power ON

Procedure	Check contents	Judgement standard	Check
Power source	Circuit breaker capacity	Outdoor unit: 45A	
		Indoor unit: 20A	
	Type of power source wiring	Outdoor unit: Select the power cable type and size in accordance with relevant local regulations.	
		Indoor unit: Select the power cable type and size in accordance with relevant local regulations.	
	Supply power source	Using a phase tester, etc., check the phase of the power source.	
		Outdoor unit side: Between L1 - L2 AC 208/230V	
		Between L2 - L3 AC 208/230V	
Between L3 - L1 AC 208/230V			
Indoor unit side: AC 208/230V			

Outdoor unit	Appearance	Shall be no scratches, deformation, etc. (Be careful of deformation of the front panel)	
	Serial No.	Shall be checked and entered in the check sheet.	
	Outside air temperature	Shall be checked and entered in the check sheet.	
	Power source wiring connection	Connection points check & loose terminal panel screws check	
	Type of communication line	22AWG (0.33mm ²), shielded wire used	
	Communication line connection	Connection points check & loose terminal panel screws check	
	Connection piping	Check whether or not the heat insulation material is installed without a gap.	
	DIP-SW setting	Outdoor unit address setting (SET : 3-1, 2)	
		Setting for number of slave units (SET : 3-3, 4)	
		Number of outdoor units installed (SET : 5-1, 2)	
	Rotary SW setting	Terminal resistor setting (SET : 5-4)	
	Additional refrigerant amount	Refrigerant circuit address setting (SET : REF AD×10 & ×1)	
	3-way valve	Comparison of calculated value and value written on electrics box. Entered in check sheet.	
		MASTER: Gas pipe shall be full-open.	
MASTER: Liquid pipe shall be full-open.			
SLAVE1: Gas pipe shall be full-open.			
SLAVE1: Liquid pipe shall be full-open.			
SLAVE2: Gas pipe shall be full-open.			
SLAVE2: Liquid pipe shall be full-open.			

[Note] If operated with the 3-way valve closed, the oil discharged from the compressor will not be returned and will lead to failures.

Indoor unit	Appearance	There shall be no scratches, deformation, tilting, etc.		
	Serial No.	Shall be checked and entered in the check sheet.		
	Drain cap installation	Shall be installed positively.		
	Power source wiring connection	Connection points check & loose terminal panel screws check		
	Type of communication line	22AWG (0.33mm ²), shielded wire used		
	Communication line connection	Connection points check & loose terminal panel screws check		
	Type of remote controller wiring	22AWG (0.33mm ²),		
	Remote controller wiring connection	Connection points check & loose terminal panel screws check		
	Connection piping	Check whether or not the heat insulation material is installed without a gap.		
		Rotary SW setting	Refrigerant circuit address (REF AD)	
		Indoor unit address (IU AD)		
		At automatic address setting, IU AD/REF AD shall be [0].		
		Remote controller address (RC AD)		
DIP-SW setting	Function setting (Remote controller custom code/ external input switching)			

1-2-2 Check Items After Power ON

[Note]

Cooling test run for each refrigerant circuit.

If multiple refrigerant circuits are test run at the same time, refrigerant circuit address setting errors cannot be detected.

Procedure	Check contents	Judgement standard	Check
Power ON	Outdoor unit circuit breaker ON	Check lighting of PC board LED101 and 7-segment display.	
	Indoor unit circuit breaker ON	Check whether or not indoor unit OPERATION and TIMER lamps flash alternately.	

[Note] Turn on all indoor units power in the same refrigerant circuit address.

When the system operates with the indoor units remaining no power, it is cause of malfunction.

Outdoor unit PC board push button SW setting/check	Function setting	Are the necessary functions set?	
--	------------------	----------------------------------	--

Address setting/check	Automatic address setting	Addresses shall be assigned to all indoor units. Check for unset or duplicated addresses.	
	Address read	All the indoor units and outdoor units of the same refrigerant circuit can be checked on the service tool.	
	Address record	Enter the set addresses in the check sheet.	
	Address hold check	Check whether or not the address setting is held by the service tool after indoor/outdoor circuit breakers were turned OFF ⇒ ON.	

Cooling test run	Outdoor unit (master) push button SW operation	All the indoor units in the same refrigerant circuit shall enter the cooling test run state. The outdoor units corresponding to the operation capacity of the indoor units shall operate. *See P01-05 described later.	
------------------	--	--	--

All of the indoor units operation (after 30 mins)	<On service tool>		
	High pressure	HPS: 392psi (2.7 MPa) *	
	Low pressure	LPS: 116psi (0.8 MPa) *	
	Discharge pipe temperature (outdoor unit)	TH1: 176.0°F (80°C) *	
	Suction pipe temperature (outdoor unit)	TH4: 66.2°F (19°C) *	
	Subcool (difference between inlet and outlet of SCHEX)	TH6 - TH7 : 18 °F (10°C) or greater *	
	Inlet air temperature (indoor unit)	TH21 : 80.6°F (27°C) *	
	Heat exchange inlet temperature (indoor unit)	TH22 : 53.6°F (12°C) *	
	Heat exchange outlet temperature (indoor unit)	TH24 : 55.4°F (13°C) *	
	Compressor operation	Shall operate corresponding to the operation capacity of the indoor units.	
	Data output	Service tool used, output (CSV ⇒ Excel)	
	<Outdoor unit>		
	Outdoor PC board/7-segment display	The 7-segment display of all outdoor units of the same refrigerant circuit shall display	
	Operation voltage	Between L1-L2 AC 208/230V 60Hz	
		Between L2-L3 AC 208/230V 60Hz	
		Between L3-L1 AC 208/230V 60Hz	
	Abnormal sound/abnormal vibration	These shall be no abnormal sound or abnormal vibration.	
		The outdoor fan shall not make a moaning sound.	
		There shall be no discharge air leaking from the outdoor duct.	
		There shall be no pipe chattering sound or flute sound generated.	
<Indoor unit service tool + actual measurement>			
Outlet air temperature	Inlet air temperature and outlet air temperature difference shall be 18°F (10°C) or greater.		
Abnormal sound/abnormal vibration	There shall be no abnormal sound or abnormal vibration.		
Water leakage check	There shall be no water leakage. There shall be no condensation on the drain, cabinet, piping, and discharge port.		
Remote controller operation	Shall operate according to the settings. (ON-OFF, set temperature change)		

Procedure	Check contents	Judgement standard	Check
Indoor unit individual operation	<Indoor unit service tool + actual measurement>		
	Fan operation	Shall be switched to all fan speeds in the cooling mode.	
	Louver operation (except duct)	Louver shall be switched to all positions. Shall also swing.	
	Outlet air temperature	Inlet air temperature and outlet air temperature difference shall be 18°F(10°C) or greater There shall be no abnormal sound or abnormal vibration.	
	Abnormal sound/abnormal vibration	There shall be no water leakage. There shall be no condensation on the drain,	
	Water leakage check	cabinet, piping, and discharge port. Shall operate according to the settings. (ON-OFF, set temperature change)	
	Remote controller operation		

*

These are representative figures of AOUA96RLBV at the standard condition.

- Cooling : Indoor temperature of 80.6°F(27.0°C), and outdoor temperature of 95°F (35.0°C) -

If conditions are different from those above mentioned, the figures will be changed slightly.

It depends on following conditions.

- Outdoor unit capacity
- Indoor and outdoor temperature
- Indoor unit capacity
- Pipe length
- etc

1-2-3 Test Run From Outdoor PC Board

All the indoor units connected to the outdoor unit can be test-operated by push button setting. (Only for master unit)

● SWITCH POSITION

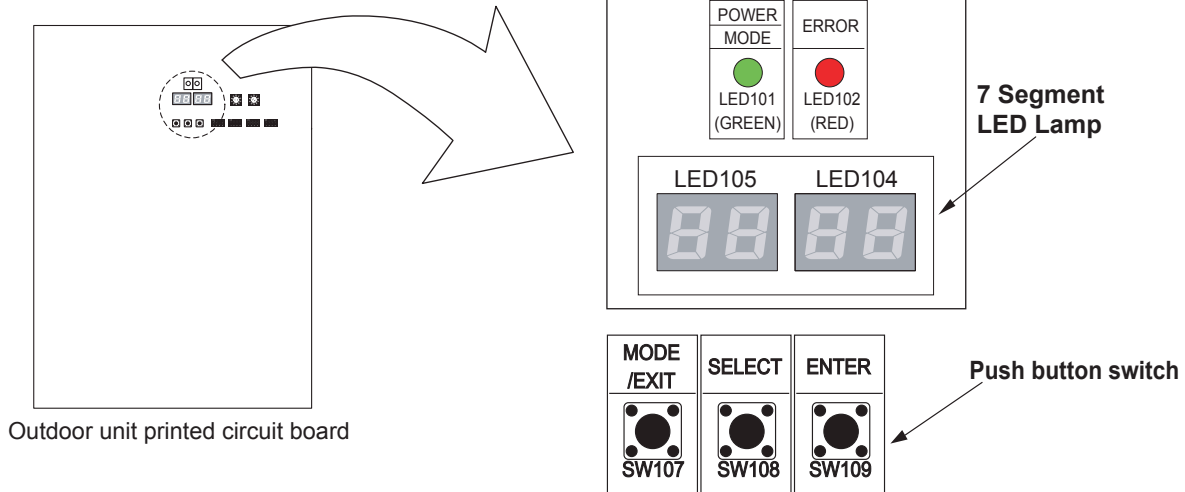

● TEST RUN SETTING

For a detailed description of push button operation, refer to the [D&T manual Chapter 6. SYSTEM DESIGN]

< Monitoring condition >

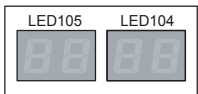

(1) Press the MODE / EXIT button (SW107) once.

< Mode select condition >

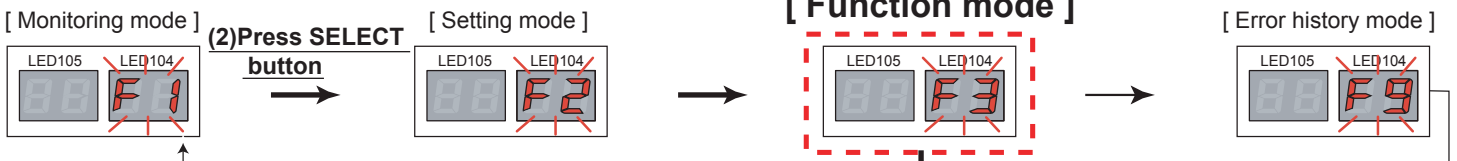

(3) Press the ENTER button (SW109)

< Function select condition >

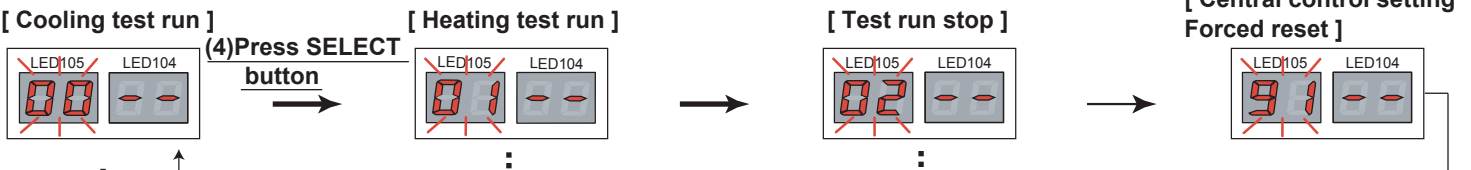

(5) Hold down the ENTER button (SW109) for at least 3 seconds.

< Pursuance completion >

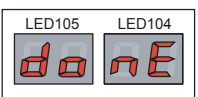

(6) Press the ENTER button (SW109) or Time out (5 seconds)

< Return to mode select condition >

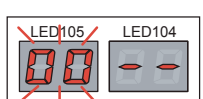

(7) Press the MODE / EXIT button

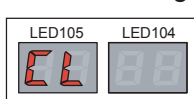

< Return to monitoring condition >





example, Normal indicate : [Cooling mode]

1-2-4 Test Run From Remote Controller

1. Standard wired remote controller

Stop the indoor unit. Push the  button and  button simultaneously for more than two seconds. The air conditioner will start to conduct a test run and "i" will display on the remote controller display.

However, the ,  setting button does not have function, but all other buttons, displays, and protection functions will operate.

- Test run operation will last for 60 Minutes if it is not manually stopped.
- To stop test run, push the START / STOP button of the standard wired remote controller.
- For the operation method, refer to the operating manual and perform operation check.
- Check that there are no abnormal sounds or vibration sounds during test run operation.

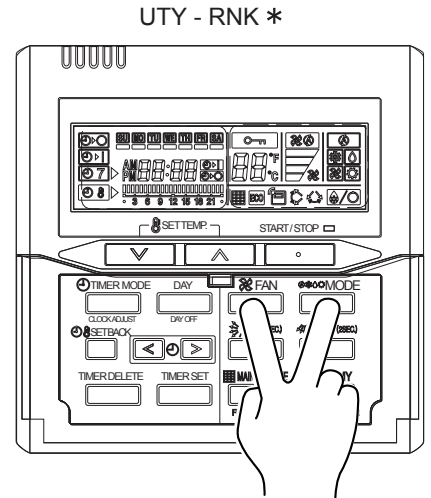



2. Standard wireless remote controller

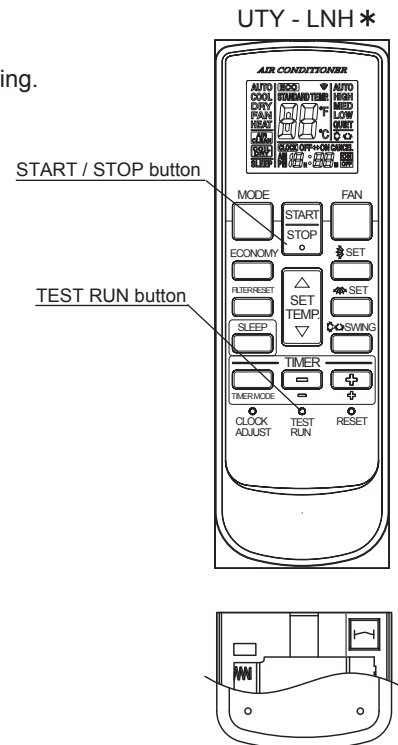

- Press the TEST RUN button on the remote controller, while the air conditioner is running.
- To end test run operation, press the remote controller START / STOP button.

When the air conditioner is being test run, the OPERATION and TIMER lamps of indoor unit flash slowly at the same time.



3. Simple remote controller

Stop the indoor and outdoor units. Push the remote controller  button and  button simultaneously for more than three seconds. The air conditioner will start to conduct a test run and "i" will display on the temperature display.

However the ,  setting button does not have function but all other buttons, displays and protection functions will operate.

- To stop test running press the  button of the simple remote controller.
- For the operation method refer to the operating manual and perform operation check.
- Check that there are no abnormal sounds or vibration sounds during test run operation.

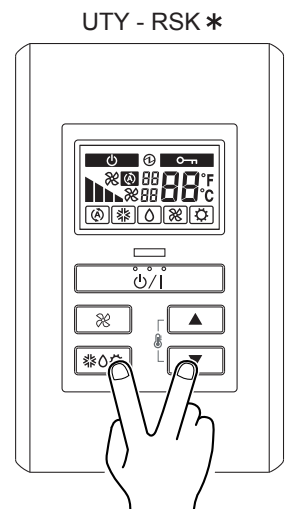

4. Central remote controller

Test run operating procedure

<Monitor screen: 9 units display>

1) Press  Button

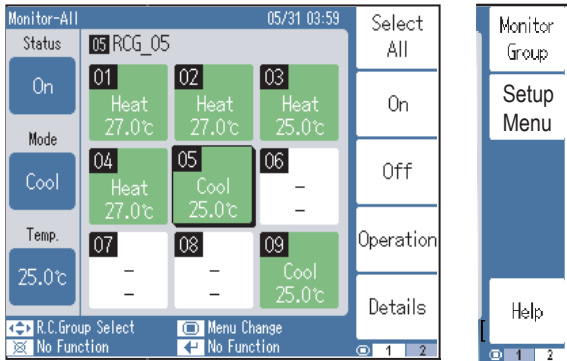

2) Press the [Setup Menu (F2)] button.

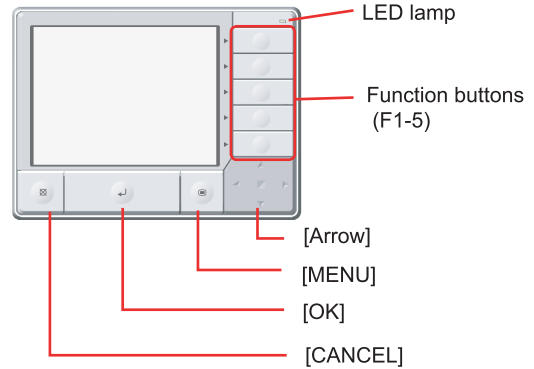

UTY- DCG



< Password verification >

3) Shift the Indoor unit special setting by pressing the [] button and [] button

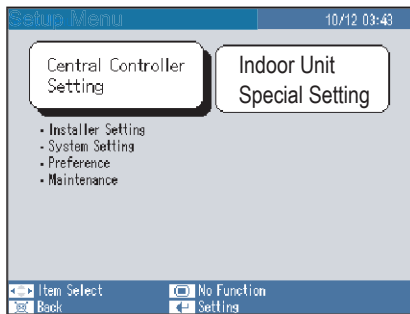

4) Shift the Test Operation by pressing the [] button and [] button

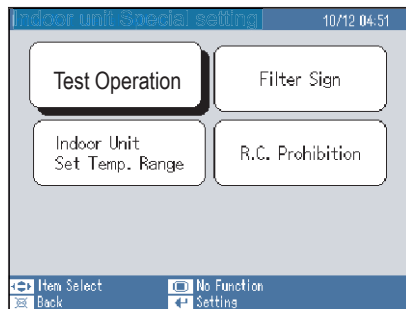

5) Press the [Select All (F2)] button,

6) Press the [Identify Unit (F3)] button

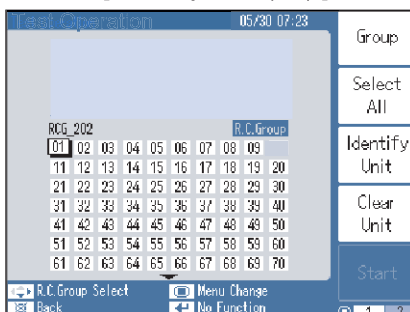

7) Press the [Start (F5)] button.

Note

There are the following 2 methods of resetting test operation.

- (1) Automatic reset when 60 minutes has elapsed.
- (2) Reset when operation stop was performed.

4. Touch panel controller

Test run operating procedure

UTY - DTG*

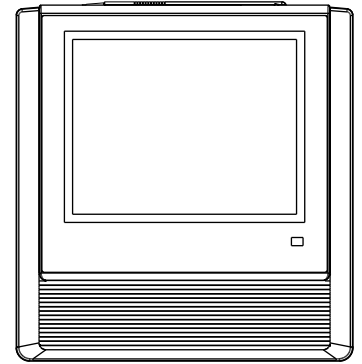

<Monitor screen (icon)>

Monitor Mode 10/11.2008.Mar. 02:20 PM Status: On

Office A On Cool 76°F	Office B On Heat 72°F	PC Room On Cool 76°F
Room 101 Off	Restrant On Auto 76°F	Entrance On Auto 76°F
Meeting 1 On Heat 76°F	Meeting 2 Off	Meeting 3 On Heat 72°F
Conference A On Heat 76°F	Conference B On Auto 72°F	Parking lot Off

Buttons: Select All (1), Clear All, Operation (2), On, Off (*)

<Monitor screen (list)>

Monitor Mode 10/11.2008.Mar. 02:20 PM Status: On

Name	Expand	Status	Mode	Set Temp	Fan	R/C Prohibit
Office A		On	Heat	72°F	High	All
Office B		Mixed	Mixed	Mixed	Mixed	Mixed
PC Room		On	Auto	76°F	Low	
Room 101		Off				
Restrant		On	Cool	80°F	Auto	
Entrance		Off				
Meeting 1		Off				

Buttons: Select All (1), Clear All, Operation (2), On, Off (*)

- (1) Select the indoor unit you want to test run.
Select the indoor unit's icon or list at the monitor screen. (Multiple selections is possible)
You can select all of the indoor units by pressing "Select All" on the monitor screen.
- (2) After indoor unit selection at (1), switch to the <Setting screen> by pressing "Operation".

<Setting screen>

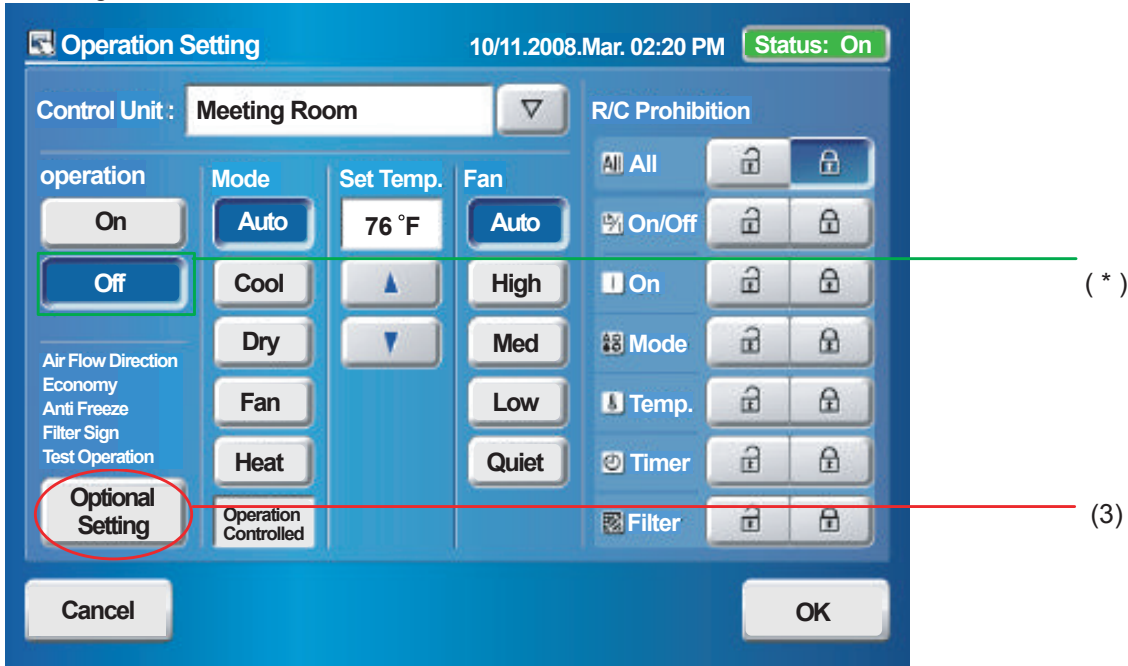

(3) Switch to the <Details setting screen> by pressing "Optional Setting" on the setting screen.

<Details setting screen>

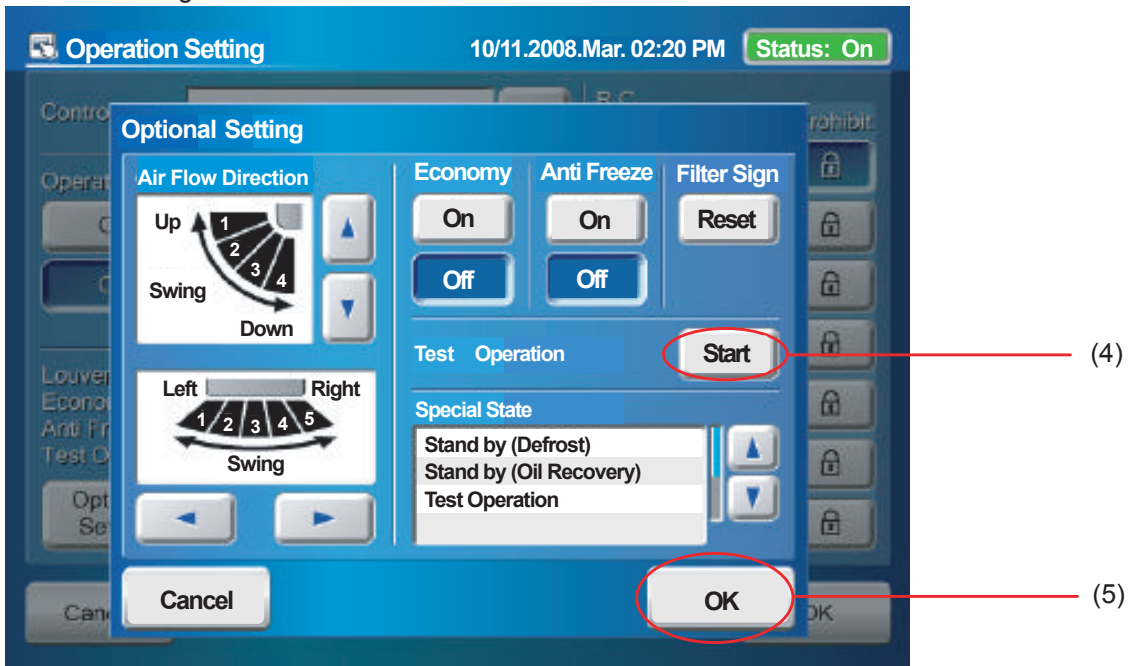

(4) Send (start) test run by pressing "Start" and then pressing "OK" on the details setting screen.

Test run operation will last for 60 Minutes if it is not manually stopped.

During sending, the slave screen shown below is displayed. When sending is completed, the sending slave screen and details setting To interrupt test run, select the device being test run and execute an operation stop command.

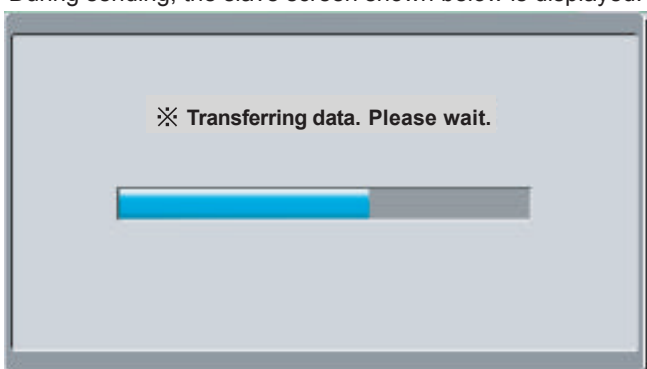

(*) At the monitor screen, test run is reset by stopping operation of the objective devices by pressing "OFF".

(*) Or test operation is reset by stopping operation of the objective devices by pressing "Off" of Operation and then pressing "OK" on the setting screen.

1-3 TEST RUN CONTROL

1. When the test run signal is transmitted from standard wired, wireless remote controller, simple remote controller, transmitted network, and outdoor unit.

- (1) The test run operation starts and the electric expansion valve is controlled to a maximum flow, regardless of the temperature condition.
- (2) Frost prevention operation has priority over item(1).
- (3) Whether state of the indoor unit operates or stops, All units in the same refrigerant circuit will start to conduct a test run in accordance with the operation mode set by push switch of outdoor unit (see 1 - 2 - 3).
- (4) After 60 minutes passes, the test run stops.(5) Test running initialization is shown below.

* Temperature controlling: The system operates without reading room temperature and the setting temperature.

Operating Mode	EXCEPT FOR THE DUCT MODEL		DUCT TYPE	
	Cooling	Heating	Cooling	Heating
Fan speed	Hi	Hi	Hi	Hi
Vertical Air Direction Panel	Position ①	Position ④	————	————
Swing	OFF	OFF	————	————

*EXAMPLE



■ COMPACT CASSETTE TYPE

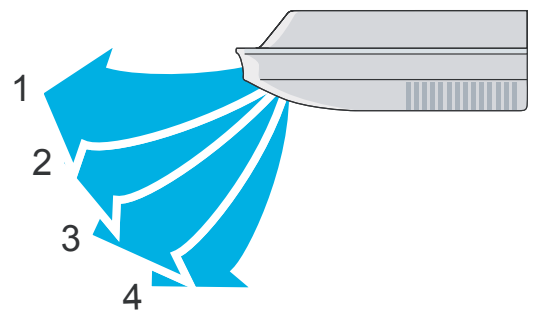

■ CEILING TYPE

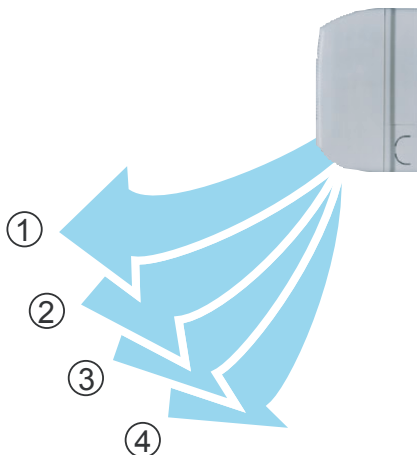

■ COMPACT WALL MOUNTED TYPE

1-4 Field Setting And Monitor Mode List for Outdoor unit

	Classification	ITEM CODE No.	Setting Mode	Information contents
Push switch on outdoor unit PCB Monitor mode [F1]	Device and system	00	Connected number of indoor unit	The number of the communicating unit is displayed
		01	Software version of outdoor unit	Software version: E●●●V○○☆■□L△△-◎
		02	Software version of INV PCB	[E●●●] [V○○] [☆■□] [L△△] [-◎] displays by five items
		03	Software version of communication PCB	It skips when there is no suffix「-◎」
	Operation of each part	10	Rotational speed of outdoor unit fan motor	The rotational speed of the outdoor unit fan motor is displayed [rpm]
		11	Rotational speed of INV compressor	The rotational speed of the compressor is displayed [rps]
		12	Current value of INV compressor	Current value of INV compressor is displayed [A]
		14	Pulse of EEV1	Pulse of EEV1 is displayed [pls]
		15	Pulse of EEV2	Pulse of EEV2 is displayed [pls]
	Time guard	20	Current accumulated run time	Accumulated current time is displayed [×10 hour]
		21	INV compressor accumulated time [Cooling]	Accumulated time is displayed in the cooling operation of the INV compressor [×10 hour]
		22	INV compressor accumulated time [Heating]	Accumulated time is displayed in the heating operation of the INV compressor [×10 hour]
	Refrigerant cycle data 1	30	Information on Thermistor 1 (INV compressor discharge temperature)	The value of the Thermistor 1 is displayed [°C] or [°F]
		32	Information on Thermistor 3 (Outdoor temperature)	The value of the Thermistor 3 is displayed [°C] or [°F]
		33	Information on Thermistor 4 (Suction temperature)	The value of the Thermistor 4 is displayed [°C] or [°F]
		34	Information on Thermistor 5 (Heat-exchanger temperature)	The value of the Thermistor 5 is displayed [°C] or [°F]
		35	Information on Thermistor 6 (Liquid temperature 1)	The value of the Thermistor 6 is displayed [°C] or [°F]
		36	Information on Thermistor 7 (Liquid temperature 2)	The value of the Thermistor 7 is displayed [°C] or [°F]
		37	Information on Thermistor 8 (Sub-cool heat-exchanger inlet temperature)	The value of the Thermistor 8 is displayed [°C] or [°F]
		38	Information on Thermistor 9 (Sub-cool heat-exchanger outlet temperature)	The value of the Thermistor 9 is displayed [°C] or [°F]
		39	Information on Thermistor 10 (INV compressor temperature)	The value of the Thermistor 10 is displayed [°C] or [°F]
	Refrigerant cycle data 2	50	Information on pressure sensor 1 (High pressure sensor)	The value of the pressure sensor 1 is displayed [MPa] or [psi]
		51	Information on pressure sensor 2 (Low pressure sensor)	The value of the pressure sensor 2 is displayed [MPa] or [psi]

	Classification	ITEM CODE No.	Setting Mode	ITEM CODE No.	Setting Function	Default	
Push switch on outdoor unit PCB Monitor mode [F2]	Install	00	Pipe length setting	00	131-213ft.(40-65m)	○	
				01	0-131ft.(0-40m)		
				02	213-295ft.(65-90m)		
				03	295-394ft.(90-120m)		
				04	394-492ft.(120-150m)		
	Correction	10	Sequential start shift	00	Normal	○	
				01	21sec. Delay		
				02	42sec. Delay		
		11	Cooling capacity shift	03	63sec. Delay		
				00	Normal mode	○	
				01	Save energy mode +4°F (+2°C)		
				02	High power mode 1 -4°F (-2°C)		
				03	High power mode 2 -7°F (-4°C)		
		12	Heating capacity shift	04	Forbidden		
				00	Normal mode	○	
				01	Save energy mode -4°F (-2°C)		
				02	High power mode 1 +4°F (+2°C)		
		13	Forbidden	03	High power mode 2 +7°F (+4°C)		
	00				○		
	01						
	00			Forced stop	○		
	01			Emergency stop			
	Change of function 1	20	Switching between forced stop or emergency stop	00	Priority given to the first command	○	
				01	Priority given to the external input of outdoor unit		
		21	Operation mode selecting method	02	Priority given to the master indoor unit		
				00	Normal operation	○	
		22	Snow falling protection fan mode	01	Snow falling protection fan mode		
				00	Standard (30min.)	○	
		23	Interval setting for snow falling protection fan mode	01	Short 1 (5min.)		
				02	Short 2 (10min.)		
				03	Short 3 (20min.)		
				00	Standard	○	
		24	High static pressure mode	01	High static pressure 1(equivalent to 0.12in.WG(30Pa))		
				02	High static pressure 2(equivalent to 0.32in.WG(80Pa))		
	03			Forbidden			
	00				○		
	25,26,27	Forbidden	00		○		
			01				
	28	Change of unit (Temperature)	00	Celsius(°C)	○		
			01	Fahrenheit (°F)			
	29	Change of unit (Pressure)	00	MPa	○		
			01	psi			
	Change of function 2	30	Energy saving level setting	00	Level 1 (stop)	○	
				01	Level 2 (operated at 40% capacity)		
				02	Level 3 (operated at 60% capacity)		
				03	Level 4 (operated at 80% capacity)		
				04	Level 5 (operated at 100% capacity)		
	31	Forbidden	00		○		
			01				
			00	Off (quiet priority)	○		
	Low noise setting 1	40	Capacity priority setting (in low noise mode)	01	On (capacity priority)		
				00	Off (Normal)	○	
				01	On (Low noise mode operation is always done)		
42	Low noise mode operation level	00	Standard (55dB)	○			
		01	Standard (50dB)				
Change of function 3	60	Back up operation	00	On*1	○		
			01	Off*2			
Change of function 4	70	Electricity meter No. setting 1 (Set the ones digit and tens digit of the No of the electricity meter connected to CN135.) *3	00~99	Setting number x00~x99 (Refer to Design & Technical Manual for details.)	00		
			71	Electricity meter No. setting 2 (Set the hundreds digit of the No. of the electricity meter connected to CN135.) *3	00~02	Setting number 0xx~2xx (Refer to Design & Technical Manual for details.)	00
			72	Electricity meter pulse setting 1 (Set the ones digit and tens digit of the No. of the electricity meter pulse setting connected to CN135.) *4	00~99	Setting number xx00~xx99 (Refer to Design & Technical Manual for details.)	00
			73	Electricity meter pulse setting 2 (Set the hundreds digit and thousands digit of the electricity meter pulse setting connected to CN135.) *4	00~99	Setting number 00xx~99xx (Refer to Design & Technical Manual for details.)	00
Change of function 5	90	Forbidden	00		○		
			01				

*1 : If one of compressor fails, backup operation will be performed by the remaining compressors.(For starting the system SET4-2 switching is required)

*2 : If one of compressor fails, all units will be abnormal stop.

*3 : When electricity meter No. is set to "000" and "201 to 299", the pulses input to CN135 become ineffective.
Available setting number is "001" to "200"

*4 : When the electricity meter pulse setting is set to "0000", the pulses input to CN135 become ineffective.
Available setting number is "0001" to "9999"

	Classification	ITEM CODE No.	Setting Mode	Setting Function
Push switch on outdoor unit PCB Monitor mode [F3]	Forced operation	00	Cooling test run	Forced thermostat-ON in Cooling.
		01	Heating test run	Forced thermostat-ON in Heating.
		02	Test run stop	Test run is stopped.
		03,04	Forbidden	
	Install and maintenance 1	10	Signal amplifier automatic address	Automatic address setting operates for signal amplifier.
		11	Indoor unit automatic address	Automatic address setting operates for indoor unit of same refrigerant circuit.
	Install and maintenance 2	20	Forbidden	
		21	Vacuuming mode	Vacuuming mode operatesRefer to page 01-01 for the function.
	Clear	30	Error history clear	All the abnormal code histories are cleared.
		31	Forbidden	
		32	Current time clear	Accumulated current time becomes [0]
		33	INV compressor accumulated time clear	Accumulated time of the INV compressor becomes [0]
		34	Forbidden	
		35	Field setting all clear	Return to default the all set items.
	Reset	40	Abnormal reset *	It was displayed when abnormality occurs, and abnormal code is reset. This is a function that uses to clear abnormal display after the Please operate the switch after power off or power on the outdoor unit.
		41	Maximum memorized indoor unit number reset	Maximum memorized indoor unit number is reset. "E14.5:Indoor unit number shortage" error is cleared.
	Specialty function	91	Foreced Central control function release	When the centralized control device failure, and the centralized control setting cannot be released, this function is used. All the limitations set with the centralized control device are released.

	Classification	ITEM CODE No.	Meaning of Error History Number	Information Contents
Push switch on outdoor unit PCB Monitor mode [F9]	Error history	00	1 time ago (Newest)	When the error occurred, the error code is memorized up to 10 on Main PCB.
		01	2 times ago	
		02	3 times ago	
		03	4 times ago	If the memorized error code becomes over 10, the oldest one will be erased.
		04	5 times ago	
		05	6 times ago	
		06	7 times ago	
		07	8 times ago	
		08	9 times ago	
		09	10 times ago (Oldest)	
Refer to Chapter TROUBLE SHOOTING Error Code List of Outdoor unit				

*< Reset Error Item List By Abnormal Reset Setting >

- Compressor Motor Loss of Synchronization
- Compressor 1 Temperature Abnormal
- Inverter Compressor Start Up Error
- Discharge Temperature 1 Abnormal
- Low Pressure Abnormal
- Current Sensor 1 Error
- Trip Detection
- Rush Current Limiting Resistor Temp Rise Protection
- Outdoor Unit FAN motor 1 Lock Error
- Outdoor Unit FAN motor 2 Lock Error

1-5 Field Setting / Function Setting for Indoor unit

	Classification	ITEM CODE No.	Setting Mode	ITEM CODE No.	Setting Function	Default	
Indoor unit field setting setting by remote controller	Address	01	Indoor unit address	00~63	00~63	00	
		02	Refrigerant circuit address	00~99	00~99	00	
	Filter	11	Filter indicator interval	00	Default	○	
				01	Longer		
				02	Shorter		
		13	Filter sign display	00	Enable	○	
	01			Disable			
	02			Display only on central remote control			
	Airflow	20	Ceiling airflow (Cassette type only)	00	Default	○	
				01	High ceiling		
		23	Vertical airflow direction (Cassette type only)	00	Default	○	
				01	Raise		
		24	Horizontal swing airflow direction (For horizontal swing equipped model)	00	Default	○	
				01	Left half		
		26*1	Static Pressure setting - Slim Duct type - The Range of static pressure is different from one model to other.	00	SP mode 00 [0 in.WG (0 Pa)]		
				01	SP mode 01 [0.04 in.WG (10 Pa)]		
				02	SP mode 02 [0.08 in.WG (20 Pa)]		
				03	SP mode 03 [0.12 in.WG (30 Pa)]		
				04	SP mode 04 [0.16 in.WG (40 Pa)]		
				05	SP mode 05 [0.20 in.WG (50 Pa)]		
				06	SP mode 06 [0.24 in.WG (60 Pa)]		
				07	SP mode 07 [0.28 in.WG (70 Pa)]		
				08	SP mode 08 [0.32 in.WG (80 Pa)]		
				09	SP mode 09 [0.36 in.WG (90 Pa)]		
				31	Normal SP [0.10 in.WG (25 Pa)]	○	
				Static Pressure setting*2*3 - Duct (high pressure) type - Range of static pressure is different from one model to other.	05	SP mode 05 [0.20 in.WG (50 Pa)]	
					06	SP mode 06 [0.24 in.WG (60 Pa)]	
					07	SP mode 07 [0.28 in.WG (70 Pa)]	
					08	SP mode 08 [0.32 in.WG (80 Pa)]	
					09	SP mode 09 [0.36 in.WG (90 Pa)]	
					10	SP mode 10 [0.40 in.WG (100 Pa)]	
11					SP mode 11 [0.44 in.WG (110 Pa)]		
12					SP mode 12 [0.48 in.WG (120 Pa)]		
13					SP mode 13 [0.52 in.WG (130 Pa)]		
14	SP mode 14 [0.56 in.WG (140 Pa)]						
15	SP mode 15 [0.60 in.WG (150 Pa)]						
16	SP mode 16 [0.64 in.WG (160 Pa)]						
17	SP mode 17 [0.68 in.WG (170 Pa)]						
18	SP mode 18 [0.72 in.WG (180 Pa)]						
19	SP mode 19 [0.76 in.WG (190 Pa)]						
20	SP mode 20 [0.80 in.WG (200 Pa)]						
21	SP mode 21 [0.84 in.WG (210 Pa)]						
22	SP mode 22 [0.88 in.WG (220 Pa)]						
23	SP mode 23 [0.92 in.WG (230 Pa)]						
24	SP mode 24 [0.96 in.WG (240 Pa)]						
25	SP mode 25 [1.00 in.WG (250 Pa)]						
26	SP mode 26 [1.04 in.WG (260 Pa)]						
27	SP mode 27 [1.08 in.WG (270 Pa)]						
28	SP mode 28 [1.12 in.WG (280 Pa)]						
29	SP mode 29 [1.16 in.WG (290 Pa)]						
30	SP mode 30 [1.20 in.WG (300 Pa)]						
31	Normal SP [0.60 in.WG (150 Pa)]	○					

*1: Please refer to FAN PERFORMANCE CURVE within Design and Technical manual for the features of each setting.

*2: If the Setting Number in ARUH96TLAV is configured to "30", the operation is the same as that in "29 (SP mode 29)".

*3: ARUH72TLAV : 04 (SP mode 04) - 27 (SP mode 27) and 31 (Normal SP)
ARUH96TLAV , ARUH72TLAV1 : 05 (SP mode 05) - 30 (SP mode 30) and 31 (Normal SP)

	Classification	ITEM CODE No.	Setting Mode	ITEM CODE No.	Setting Function	Default
Indoor unit field setting setting by remote controller	Correction	30	Cool air temperature trigger	00	Default 0°F(0°C)	○
				01	Temperature overshoot setting +4°F(+2°C)	
				02	Temperature undershoot setting -4°F(-2°C)	
		31	Heat air temperature trigger	00	Default 0°F(0°C)	○
				01	Temperature undershoot setting -11°F(-6°C)	
				02	Temperature slightly unndershoot setting -7°F(-4°C)	
	Change of function 1	40	Auto restart *1	00	Enable	
				01	Disable	○
		43	Cool air prevention	00	Enable	○
				01	Disable (Ventilation mode)	
		46	External control	00	Start / Stop	○
				01	Emergency stop *2	
				02	Forced stop *3	
		47	Error report target	00	All	○
				01	Display only for central remote control	
		49	Fan setting when cooling thermostat OFF (Duct (72/96) type only)	00	Follow the setting on the remote controller	○
				01	Stop	
		Change of function 2	60	Switching functions for external inputs and external outputs terminals (Duct (72/96) type only)	00	Mode 0
	01				Mode 1	
	02				Mode 2	
	03				Mode 3	
	04				Mode 4	
	05				Mode 5	
	06				Mode 6	
	07				Mode 7	
	08				Mode 8	
	61		Control switching of external heaters (Duct (72/96) type only)	00	Auxiliary heater control 1	○
				01	Auxiliary heater control 2	
				02	Heat pump prohibition control	
				03	Heater selection control using outdoor temperature 1	
	62		Operating temperature switching of external heaters (Duct (72/96) type only)	04	Heater selection control using outdoor temperature 2	
00				Setting 0	○	
01		Setting 1				
02		Setting 2				
03		Setting 3				
			04	Setting 4		
			05	Setting 5		

*1: Auto restart is an emergency function such as for power failure etc.

Do not start and stop the indoor unit by this function in normal operation.

Be sure to operate by the control unit, converter or external input device.

*2: If an emergency stop is performed from an external controller, same refrigerant system will be disabled.

*3: If forced stop is set, indoor unit stops by the input to the external input terminals, and Start/Stop by a remote controller is restricted.

1-6 Field Setting / Function Setting for Outdoor air unit

	Classification	ITEM CODE No.	Setting Mode	ITEM CODE No.	Setting Function	Default			
Indoor unit field setting setting by remote controller	Address	00	Indoor unit address	00~63	00~63	00			
		02	Refrigerant circuit address	00~99	00~99	00			
	Filter	11	Filter indicator Interval	00	Default	○			
				01	Longer				
		13	Filter sign display	00	Enable				
				01	Disable	○			
	Airflow	26	Static Pressure setting - Outdoor air unit Only - The Range of static pressure is different from one model to other.	02	Display only on central remote control				
				05	SP mode 05 [0.20 in.WG (50 Pa)]				
				06	SP mode 06 [0.24 in.WG (60 Pa)]				
				07	SP mode 07 [0.28 in.WG (70 Pa)]				
				08	SP mode 08 [0.32 in.WG (80 Pa)]				
				09	SP mode 09 [0.36 in.WG (90 Pa)]				
				10	SP mode 10 [0.40 in.WG (100 Pa)]				
				11	SP mode 11 [0.44 in.WG (110 Pa)]				
				12	SP mode 12 [0.48 in.WG (120 Pa)]				
				13	SP mode 13 [0.52 in.WG (130 Pa)]				
				14	SP mode 14 [0.56 in.WG (140 Pa)]				
				15	SP mode 15 [0.60 in.WG (150 Pa)]				
				16	SP mode 16 [0.64 in.WG (160 Pa)]				
				17	SP mode 17 [0.68 in.WG (170 Pa)]				
				18	SP mode 18 [0.72 in.WG (180 Pa)]				
				19	SP mode 19 [0.76 in.WG (190 Pa)]				
				20	SP mode 20 [0.80 in.WG (200 Pa)]				
				21	SP mode 21 [0.84 in.WG (210 Pa)]				
				22	SP mode 22 [0.88 in.WG (220 Pa)]				
				Change of function 1	40, 43, 46, 47	Auto restart *1 Cool air prevention External control Error report target	31	Normal SP	○
							00	Enable	
							01	Disable	○
	00	Super low							
	01	Follow the setting on the remote controller	○						
	00	Start / Stop	○						
	01	Emergency stop							
	02	Forced stop (Start/Stop by RC is restricted)							
	Change of function 2	60,61,62, 63, 65	Forbidden Humidifier control *2 Threshold temperature setting for cool / heat switch over*3	01	Display only for central remote control	○			
				00					
				00	mode 00	○			
				01	mode 01				
				02	mode 02				
				00	mode 0 ±10°F (±5°C)	○			
	01	mode 1 +4°F (±2°C)							
	02	mode 2 +6°F (±3°C)							
	03	mode 3 +8°F (±4°C)							
04	mode 4 +10°F (±5°C)								
05	mode 5 +12°F (±6°C)								
06	mode 5 +14°F (±7°C)								

*1: Auto restart is an emergency function such as for power failure etc.

Do not start and stop the indoor unit by this function in normal operation.
Be sure to operate by the control unit, converter or external input device.

*2: Select control conditions of external output.

"Mode 00" is output when heating thermostat is ON, "Mode 01" is output in heating operation, "Mode 02" is output in heating operation and in fan operation.

*3: Threshold temperature setting for cool / heat mode under auto operation ; Set temperature ±4°F (±2°C) to ±14°F (±7°C)

*Cool / heat mode tends to be switched as the threshold temperature range gets smaller,
and cool / heat mode becomes difficult to be switched as the threshold temperature range gets larger.
Set the proper value according to use conditions.



AIRSTAGE™ V-II

Variable Refrigerant Flow System

2. OUTDOOR UNIT OPERATION CONTROL

2. OUTDOOR UNIT OPERATION CONTROL

2-1 INPUT / OUTPUT LIST

		Input / output or kind of detail	Control range
I N P U T	Discharge pressure sensor Suction pressure sensor Discharge temperature sensor 1 Outdoor temperature sensor Suction temperature sensor Heat exchanger temperature sensor Liquid temperature sensor 1 Liquid temperature sensor 2 Sub-cool heat exchanger (inlet) sensor Sub-cool heat exchanger (outlet) sensor Compressor temperature sensor 1 Operation current sensor Pressure switch 1 (Inverter comp)	Pressure sensor Pressure sensor Thermistor Thermistor Thermistor Thermistor Thermistor Thermistor Thermistor Thermistor Thermistor Thermistor Thermistor Thermistor Thermistor Current transformer Pressure switch	Measure range 0.0 to 5.0MPa (0 to 725psi) Measure range 0.0 to 1.7MPa (0 to 247psi) Measure range 10 to 130°C (50 to 266°F) Measure range -25 to 58°C (-13 to 136°F) Measure range -35 to 70°C (-31 to 158°F) Measure range -35 to 70°C (-31 to 158°F) Measure range -35 to 70°C (-31 to 158°F) Measure range -35 to 70°C (-31 to 158°F) Measure range -35 to 70°C (-31 to 158°F) Measure range -35 to 70°C (-31 to 158°F) Measure range -35 to 70°C (-31 to 158°F) Measure range 10 to 130°C (50 to 266°F)
	Rotary SW & DIP-SW & Push SW	Address and function setting	Open 4.2MPa(609psi) / Short 3.2MPa(464psi)
O U T P U T	Compressor 1 (Inverter) Electronic expansion valve 1 (Main) Electronic expansion valve 2 (SC-Hex) Fan motor 4-way valve 1 Solenoid valve 1 Solenoid valve 2 Solenoid valve 3 Crank case heater 1 Base heater	Magnetic relay EEV coil EEV coil DC Brushless motor 4-way valve coil Hot gas bypass INV Comp pressure equalizing valve ACM oil return valve1. For Inverter Compressor Field supply	Operation coil AC208-230V, 60Hz Operating voltage DC12V Operating voltage DC12V AC208-230V, 60Hz 6/5 W AC208-230V, 60Hz 8W AC208-230V, 60Hz, 6W AC208-230V, 60Hz, 6W AC230V, 25W AC208-230V, 35W
Communication Input / Output	LoN WORKS® Inverter communication Outdoor unit communication	Indoor unit ↔ Outdoor unit Outdoor unit ↔ Outdoor unit	
External Input / Output	External input 1 (CN131) (Low noise mode operation) External input 2 (CN132) (Cooling / Heating priority) External input 3 (CN133) (Outdoor unit operation peak control) External input 4 (CN134) (Emergency stop operation)	Dry contact input	
	External output 1 (CN136) (Error display) External output 2 (CN137) (Operation display)	ON (Error) / OFF (Normal) ON (Operation) / OFF (Stop)	Control output: DC 0/12-24V, Max.30mA Control output: DC 0/12-24V, Max.30mA
LED display	Single LED 101 Single LED 102 7 Segment LED	Display the information on operation, error and setting with single LED and 7 segment LED.	

2-2 COMPRESSOR OPERATION

2-2-1 Operation / Stop Condition

When cooling requirement capacity or heating requirement capacity from either of the indoor units in the same refrigerant circuit is input, the compressor operates.

When all the indoor units in no "cooling requirement capacity" or "heating requirement capacity", the compressor is stopped.

But in the following case, the compressor operates in accordance with operation of each mode.

- During 3 minute restart prevention operation
- Icing protection
- Failure (Refer to chapter 4, TROUBLE SHOOTING)
- Oil recovery
- Under expansion valve initialization
- At protective operation
- Emergency stop
- Defrost operation
- Peak cut stop operation

2-2-2 Capacity Control

(1) Capacity of compressor operation

By combining the operation of DC inverter rotary compressor, the amount of required refrigerant circulation according to cooling and heating load can be supplied from compressor efficiently.

DC inverter rotary compressor is able to control the amount of required refrigerant circulation in details.

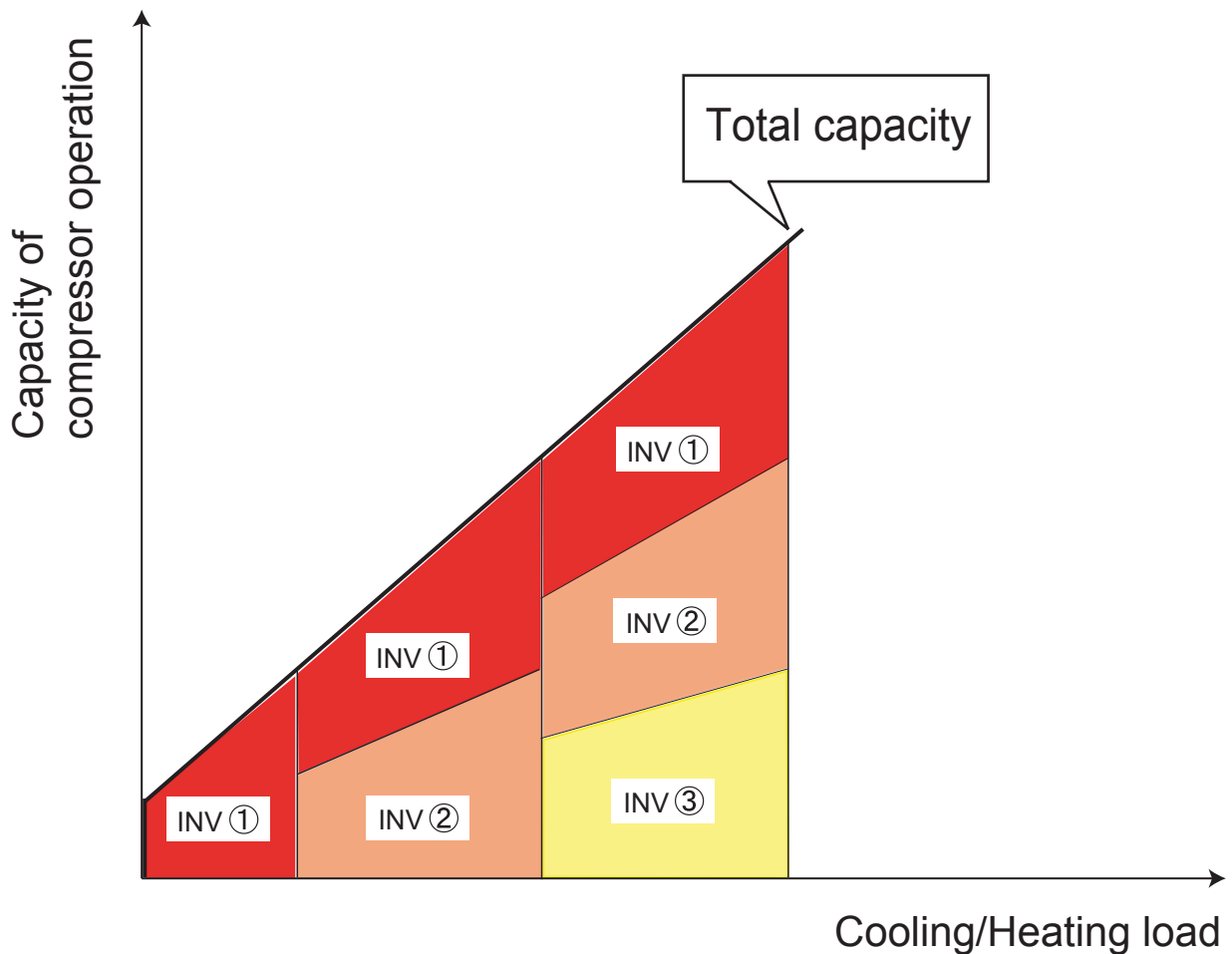

(2) Target low-pressure and high-pressure control

<Cooling>

In order to make the evaporation pressure of the indoor unit at the proper pressure on a variety of operations, capacity of the compressor will be controlled by low-pressure sensor of the outdoor unit (Master unit).

<Heating>

In order to make the condensation pressure of the indoor unit at the proper pressure on a variety of operations, capacity of the compressor will be controlled by high-pressure sensor of the outdoor unit (Master unit).

Target low-pressure and high pressure temperature depends on system capacity, capacity of compressor operation, pipe length, and capacity shift switch settings.

2-2-3 Speed Range of Start, Stop, And Operation (For DC Inverter Rotary Compressor)

- On stop mode : 0 rps
- On operating mode : 30 - 100 rps
- Master and slave inverter compressors rotational speed are controlled the same
(In the case of multi outdoor unit)

(1) Cooling starting process

- For cooling operation only, the upper limit speed at starting is made 50rps and is raised in +10rps increments every 60 seconds.

- The compressor operates at the upper limit speed if the target speed is higher than the upper limit speed.
- The compressor operates at the target speed if the target speed is lower than the upper limit speed.

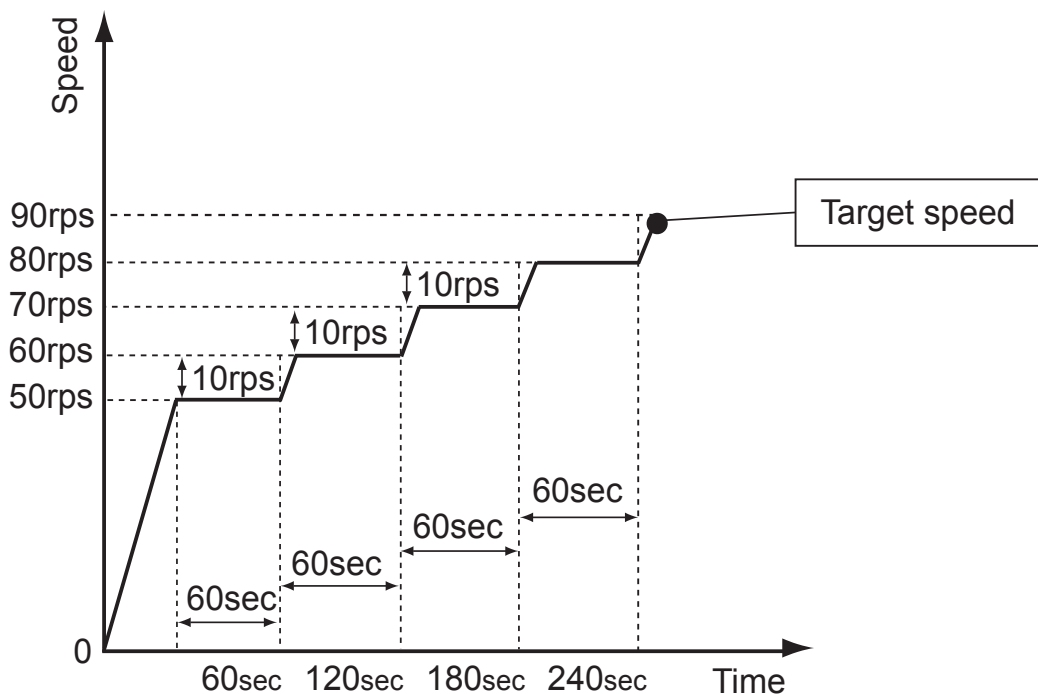

(2) Heating starting process

At the start of heating, the compressor is started by the following process. The compressors start-up to change the 4 way valve. Capacity control returns to normal control after the end of the starting process. (target high-pressure control)

< Starting process >

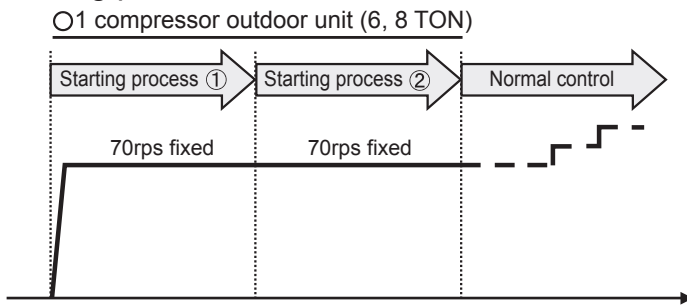

	End conditions
Starting process ①	7 minutes elapsed from start of process ① or 1 minute elapsed from start of process ① and high-pressure of all outdoor units $\geq 363\text{psi}$ (2.50MPa)
Starting process ②	30 minutes elapsed from start of process ② or high-pressure of all outdoor units $\geq 381\text{psi}$ (2.63MPa) or discharge SH of all operating compressors $>54^\circ\text{F}$ (12°C)

*However, when the following condition (A) or (B) are satisfied, starting process is not performed.

< Conditions under which starting process is not performed >

- (A) When outside air temperature $>68^\circ\text{F}$ (20°C)
- (B) When the system has ever operated in heating mode and it is within 30 minutes after stop. (including thermostat OFF stop)

< Operation >

Inverter compressor of all outdoor unit is started at 40rps and normal control immediately begins. (target high-pressure control)

(3) Limits the upper limit speed of the INV compressor according to the present high-pressure value.

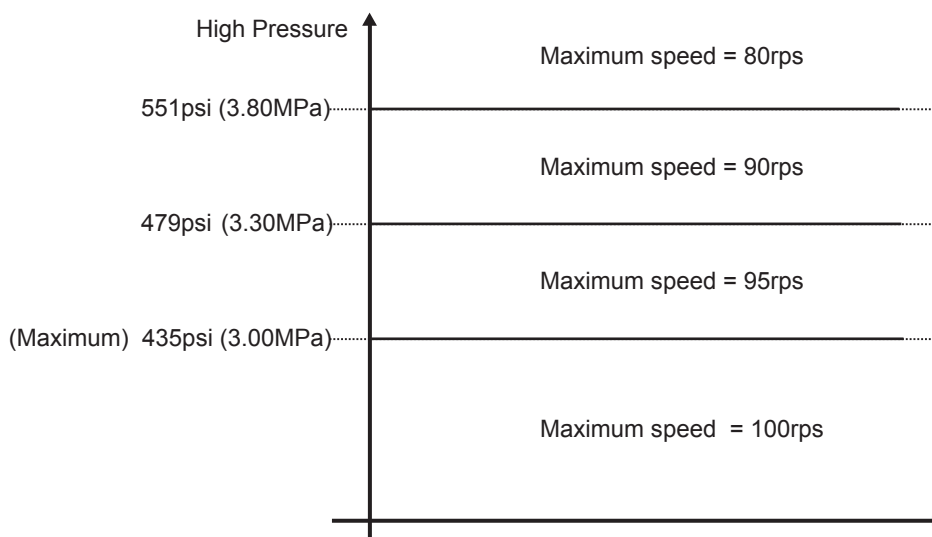

2-2-4 Compressor Sequence Operation

Make starting sequence and start and stop of the compressors in accordance with the below sequence.

Example) Starting sequence ①: Compressor started first, compressor stopped last

Starting sequence ②: Compressor started 2nd, compressor stopped 2nd from the end

- Operate so that the speed of the operating INV compressors is the same.
(May also vary with the upper limit & lower limit speed restriction)
- Rotate the starting sequence under the following conditions:
 - Defrosting
 - Oil recovery
 - When cooling discharge temperature is high

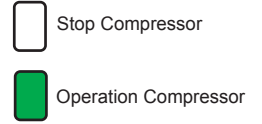

CONST. : Constant speed compressor
INV : Inverter compressor

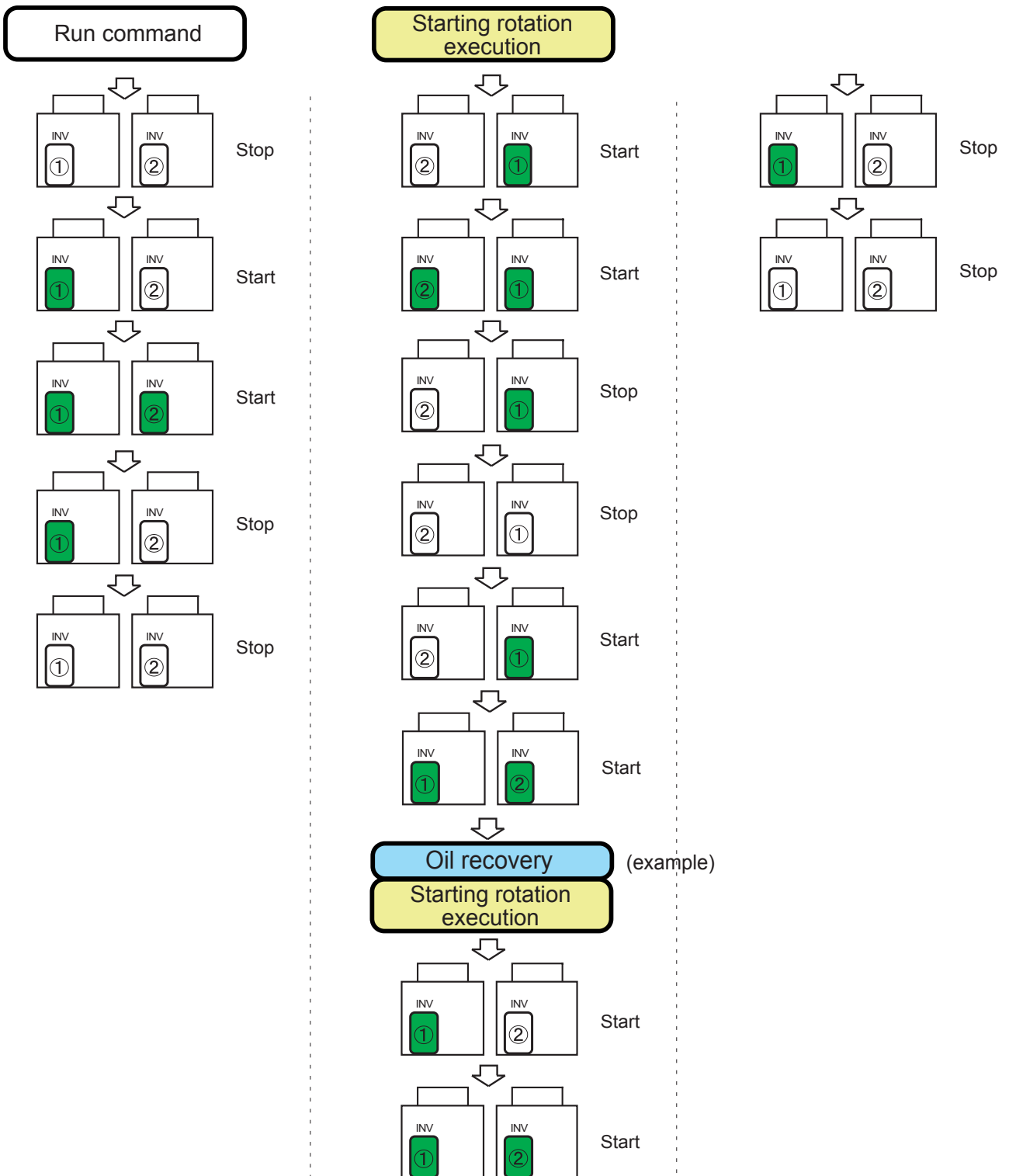

2-3 FAN CONTROL

2-3-1 Cooling Operation

Fan step	Fan speed (rpm)	
	AOUA72RLBV	AOUA96RLBV
16	880	880
15	860	860
14	810	810
13	720	720
12	600	600
11	500	500
10	420	420
9	360	360
8	320	320
7	300	300
6	intermittent 6	intermittent 6
5	intermittent 5	intermittent 5
4	intermittent 4	intermittent 4
3	intermittent 3	intermittent 3
2	intermittent 2	intermittent 2
1	intermittent 1	intermittent 1
0	0	0

- Switching conditions of step
The initial speed of the outdoor unit is detected by out door temperature sensor.

Outside air temperature sensor detected value	Fan step
TAOUT > 86°F (30°C)	16
86°F (30°C) ≥ TAOUT > 68°F (20°C)	10
68°F (20°C) ≥ TAOUT > 50°F (10°C)	7
50°F (10°C) ≥ TAOUT	0

The fan is controlled to keep high pressure saturation temperature within the target range as follows

High-pressure saturation temperature

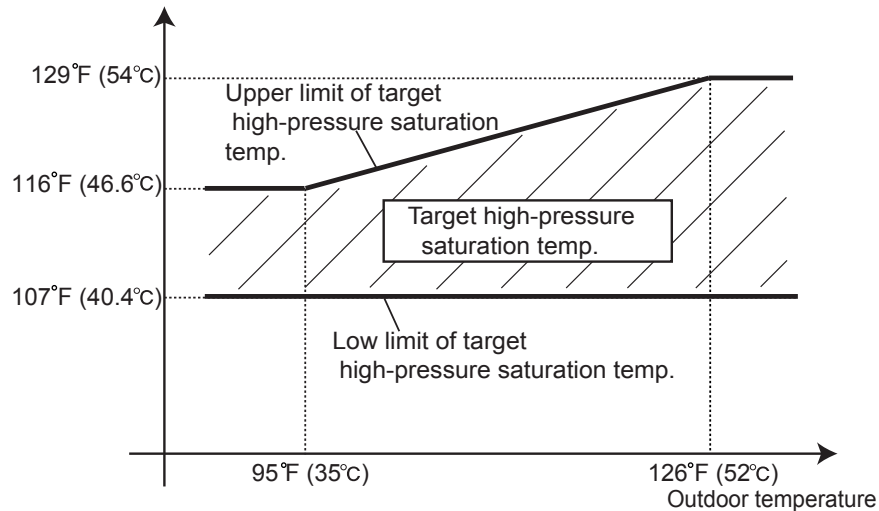

Thereafter, the high-pressure is monitoring at a set time interval and the fan speed is changed by the following conditions.

(Conditions which lower the fan speed)

High-pressure saturation < low limit of target high-pressure saturation range and heat sink temperature ≤ 167°F (75°C)

(Conditions which raise the fan speed)

High-pressure saturation > upper limit of target high-pressure saturation or heat sink temperature ≥ 176°F (80°C)

● Intermittent fan mode

Fan step	Fan mode	Fan speed 0 rpm duration time T (sec)	Fan speed 300 rpm duration time (sec)
6	intermittent 6	6	7
5	intermittent 5	12	
4	intermittent 4	19	
3	intermittent 3	26	
2	intermittent 2	33	
1	intermittent 1	40	

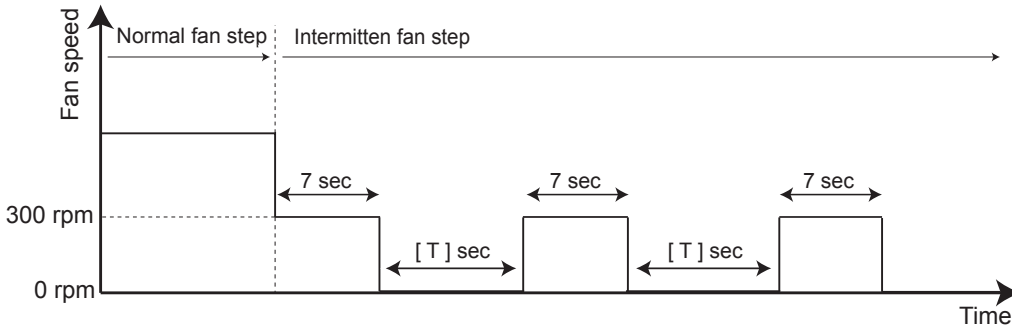

When switched from normal fan step to intermittent fan step, always start from 300rpm/7sec.
When there was a change during intermittent step 1-6, switching is performed at the time the current speed duration time reaches time-up.

2-3-2 Heating Operation

Fan step	Fan speed (rpm)	
	AQUA72RLBV	AQUA96RLBV
16	880	880
15	860	860
14	830	830
13	700	700
12	600	600
11	500	500
10	420	420
9	360	360
8	320	320
7	300	300

● Switching conditions of step

The initial speed of the first boot outdoor unit is detected by outdoor air temperature sensor value (TAOUT).

Outside air temperature sensor detected value	Fan step
TAOUT < 50°F (10°C)	16
50°F (10°C) ≤ TAOUT < 59°F (15°C)	12
59°F (15°C) ≤ TAOUT < 68°F (20°C)	7
68°F (20°C) ≤ TAOUT	7

Thereafter, the high-pressure is monitoring at a set time interval and the fan speed is changed by the following conditions.
Other outdoor units are normally operated at fan step 16.

(Condition which lowers the fan speed)

High-pressure ≥ 479psi (3.30MPa) and heat sink temperature ≤ 167°F (75°C)

(Condition which raises the fan speed)

High-pressure saturation ≤ 464psi (3.20MPa) or heat sink temperature ≥ 176°F (80°C)

2-3-3 Low noise mode

When the low noise mode setting ON from PUSH SW or EXTERNAL INPUT, the outdoor unit operates in the low noise mode as follows.

«Settings and corresponding operations»

Capacity priority setting (PUSH SW)	Low noise level setting (PUSH SW)	Operation mode
OFF	LEVEL 1	LOW NOISE MODE ①
	LEVEL 2	LOW NOISE MODE ②
ON	LEVEL 1	* Automatic switching ①
	LEVEL 2	* Automatic switching ②

«Low noise mode and operation contents»

		6TON	8TON
LOW NOISE MODE ①	COOL	Fan upper limit speed	600rpm
		Upper limit compressor capacity	INV 45rps
	HEAT	Fan upper limit speed	600rpm
		Upper limit compressor capacity	INV 47rps
LOW NOISE MODE ②	COOL	Fan upper limit speed	500rpm
		Upper limit compressor capacity	INV 45rps
	HEAT	Fan upper limit speed	500rpm
		Upper limit compressor capacity	INV 45rps

The constant speed compressor is stopped in the LOW NOISE MODE ① and ②

The operating noise is reduced by limiting the rotational speed of the inverter compressor and fan motor

LOW NOISE MODE ① • • • The operating sound lowers about 55 dB.

LOW NOISE MODE ② • • • The operating sound lowers about 50 dB.

* Automatic switching ①

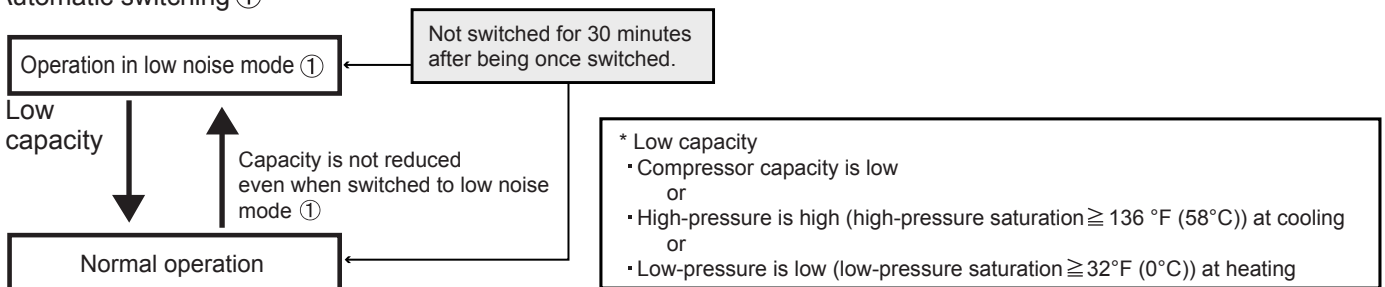

* Automatic switching ②

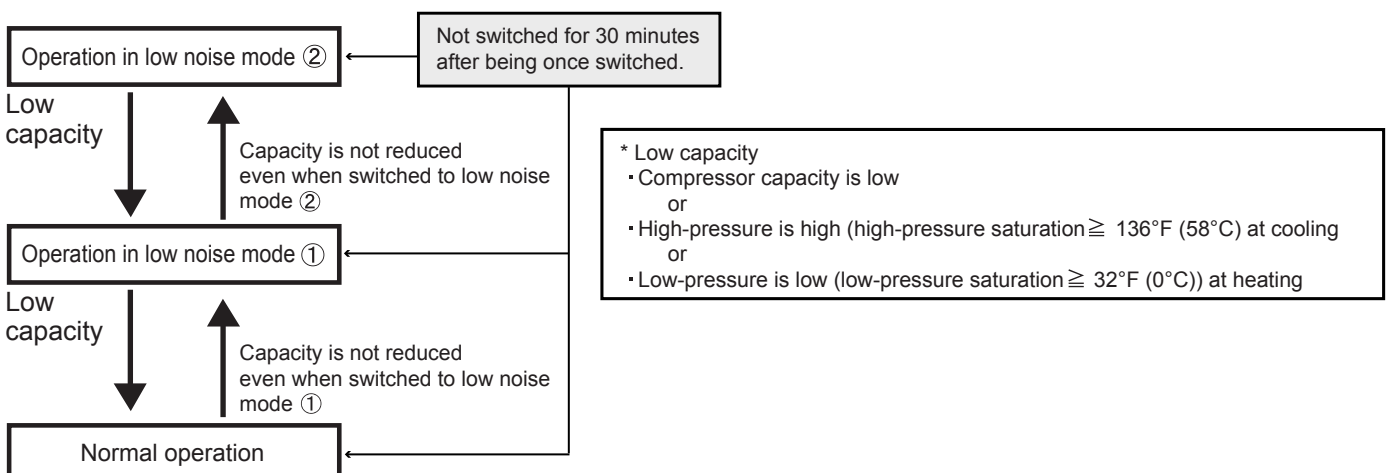

2-3-4 Snow Falling Protection Fan Mode

The fan rotation is forced into maximum speed when the outdoor temperature becomes 41°F (5°C) or less when snow falling protection fan mode is set on.

The fan is rotated for 1 minute at the fan step upper limit at the interval set by PUSH SW.

This mode ends when the outdoor temperature becomes 45°F (7°C) or more or operation starts.

(Operation contents)

Interval setting	PUSH SW setting (F2 - 23)	Interval time Int (min)
setting④ (standard)	00	30
setting①	01	5
setting②	02	10
setting③	03	20

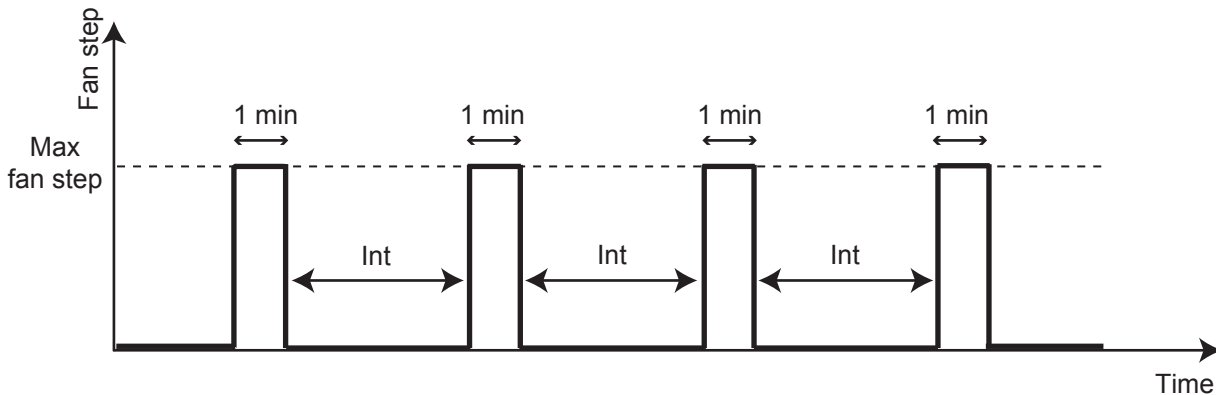

2-3-5 Other Control

To accurately detect the outside air temperature, the fan is operated while the outdoor unit is stopped.

2-4 EXPANSION VALVE CONTROL

	Initialization conditions	Operation mode	Control range	
			operation	stop
EEV 1	① When power turned on	Cooling	0 pulses	0 pulses
		Heating	55 - 500 pulses	
EEV 2	② When operation stopped	Cooling	55 - 500 pulses	0 pulses
		Heating		

< Cooling mode >
0 pulses basically.

< Heating mode >

EEV is controlled so that the system reaches closer to the target discharge temperature that is calculated from high and low pressure.

2-5 SPECIAL OPERATION

2-5-1 Oil Recovery Operation

(1) Purpose of the operation

The amount of refrigerant lubricant oil which has been transported to the indoor units and the connection pipe with the refrigerant will accumulate as the operation time of compressor increases. It is necessary to recover the oil back into the outdoor unit for a certain time interval in order to prevent compressors from damaging due to lack of lubrication oil.

① Simple oil recovery operation < Oil recovery from the gas main pipe > (Only cooling mode)

< Start condition >

Suction temperature — low pressure saturation temperature $\geq 50^{\circ}\text{F}$ (10°C) continues for 30 minutes

< End condition >

Suction temperature — low pressure saturation temperature $\leq 45^{\circ}\text{F}$ (7°C)

< Operation >

Indoor unit : Expansion valve of operating indoor unit gradually opened

Outdoor unit : Normal cooling operation

② Cooling oil recovery operation

< Start condition >

Compressor accumulated operation time since last cooling oil recovery operation exceeds 3 hours (first time : 1hour)

< End condition >

30 seconds have elapsed since the start and "suction temperature - low pressure saturation temperature $\leq 41^{\circ}\text{F}$ (5°C)" at all outdoor units or 6 minutes have elapsed since the start.

< Operation >

COMPRESSOR: Performed by all INV compressors operating up until now

INV speed varies depending on the operation state.

EEV Opening (Indoor/Outdoor unit): Controlled pulse (as normal operation mode).

FAN speed (Indoor/Outdoor unit) : Controlled fan speed (as normal operation mode).

③ Heating oil recovery operation

< Start condition >

Compressor accumulated operation time since the last heating oil recovery exceeds 8 hours (first time : 1hour)

< End condition >

After 4 minutes have elapsed

< Operation >



COMPRESSOR: Performed by all INV compressors operating up until now

INV speed varies depending on the operation state.

EEV Opening (Indoor/Outdoor unit) : Controlled pulse (as normal operation mode)

FAN speed (Indoor/Outdoor unit) : Controlled fan speed (as normal operation mode)

Others

During the oil recovery operation,  appears on the display of wired remote controller, and  appears on the simple remote controller.

The operation indicators (LED) of the indoor units flash slowly.

2-5-2 Pre-heat Operation

This pre-heat operation protects the start up failure by preventing the refrigerant from migrating into the compressor crank case.
Crankcase heater ON: 30 minutes elapsed since installed compressors stopped (However, ON when power turned on)
OFF: installed compressors operation
*It doesn't control according to the temperature.

2-5-3 Defrost Operation Control

< Defrosting start condition >

Accumulated heating operation time is 40 minutes or longer
[Accumulated heating operation time is reset at the end of cooling operation or defrosting operation.]
and
an outdoor unit satisfies condition ① or ② below

Condition : "Heat exchange temperature $\leq 28.4^{\circ}\text{F} (-2^{\circ}\text{C})$ " accumulated operating time is 180 minutes or longer
① (75 minutes for indoor unit connection capacity $\leq 90\%$ at 1 outdoor unit connection)

Condition : After the following all condition satisfied, "heat exchange temperature \leq defrosting start judgment
② temperature and during heat exchange liquid temperature drop" accumulated time:10minutes
(a) accumulated heating operation time ≥ 30 minutes
(b) 10 minutes have elapsed after outdoor unit starting
(c) 5 minutes have elapsed since oil recovery

* Defrosting start and end judgment temperature are determined by the outdoor temperature.

Defrosting start judgment temperature($^{\circ}\text{C}$) = $0.8 \times \text{Outdoor temperature } (^{\circ}\text{C}) - 11.6$
 \Rightarrow Defrosting start judgment temperature($^{\circ}\text{F}$) = $0.8 \times \text{Outdoor temperature } (^{\circ}\text{F}) - 52.9$
* However , $-17.7^{\circ}\text{F}(-27.6^{\circ}\text{C})$ to $21.2^{\circ}\text{F} (-6^{\circ}\text{C})$

If the calculated result is lower than $-17.7^{\circ}\text{F} (-27.6^{\circ}\text{C})$, the judgment temperature is defined as $-17.7^{\circ}\text{F}(-27.6^{\circ}\text{C})$
If the calculated result is higher than $21.2^{\circ}\text{F}(-6^{\circ}\text{C})$, the judgment temperature is defined as $21.2^{\circ}\text{F}(-6^{\circ}\text{C})$

< Defrosting end condition >

① At all outdoor units, heat exchange liquid temperature \geq end judgment temperature
or

② When 10 minutes have elapsed from the start
(When the indoor unit connection capacity is 90% or less, after 15 minutes have elapsed.)

\Rightarrow Defrosting end judgment temperature($^{\circ}\text{C}$)= $0.39 \times \text{outdoor temperature} (^{\circ}\text{C}) + 12.7$
Defrosting end judgment temperature($^{\circ}\text{F}$) = $0.39 \times \text{outdoor temperature} (^{\circ}\text{F}) + 54.8$
* However, $41.0^{\circ}\text{F} (5^{\circ}\text{C})$ to $53.6^{\circ}\text{F}(12^{\circ}\text{C})$ range

If the calculated result is lower than $41.0^{\circ}\text{F}(5^{\circ}\text{C})$, the judgment temperature is defined as $41.0^{\circ}\text{F} (5^{\circ}\text{C})$
If the calculated result is higher than $53.6^{\circ}\text{F}(12^{\circ}\text{C})$, the judgment temperature is defined as $53.6^{\circ}\text{F}(12^{\circ}\text{C})$

< Operating state of each part during defrosting operation >

Indoor unit EEV : Open FAN : Stop

Outdoor unit FAN : Stop Compressor : In operation

[STEP 1]

All compressors operates and it defrosting.

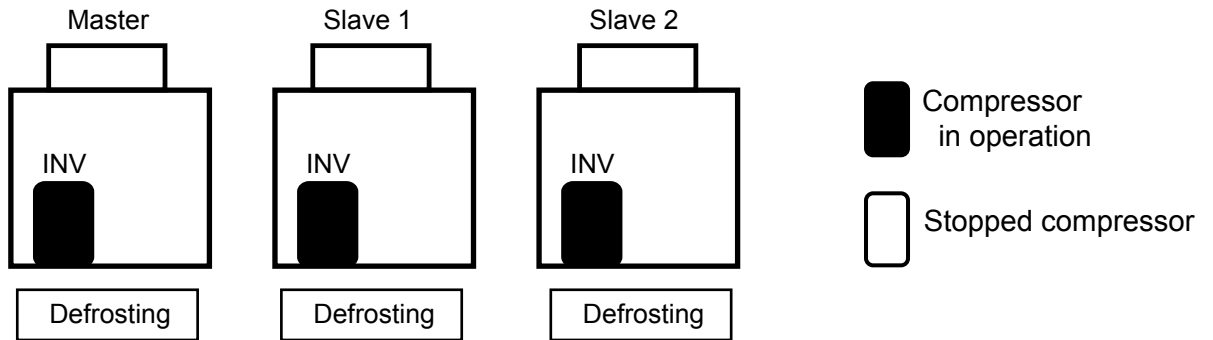

[STEP 2]

Outdoor units which satisfied the defrost end judgment temperature are stopped for constant speed compressor and are operated at the lowest speed (30rps) for inverter compressor.

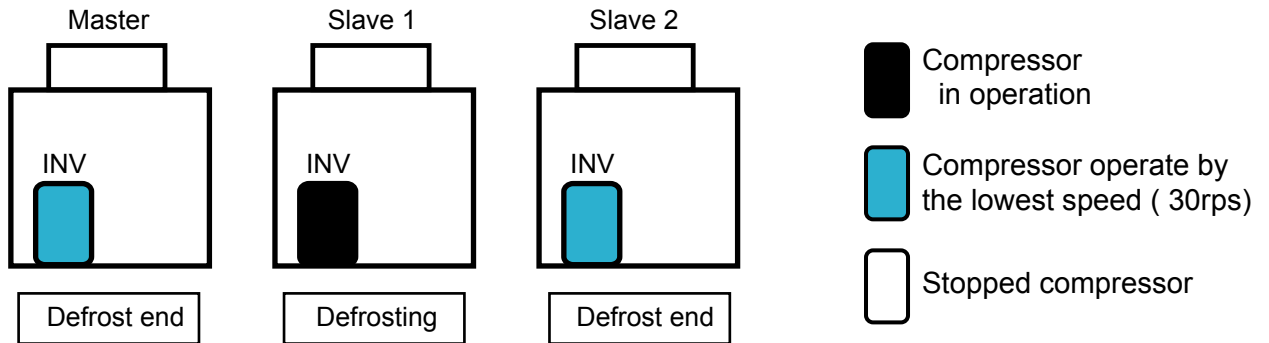

[STEP 3]

When the defrost of all outdoor units ends, all outdoor unit stop. The start rotation execution is done, and restarts.

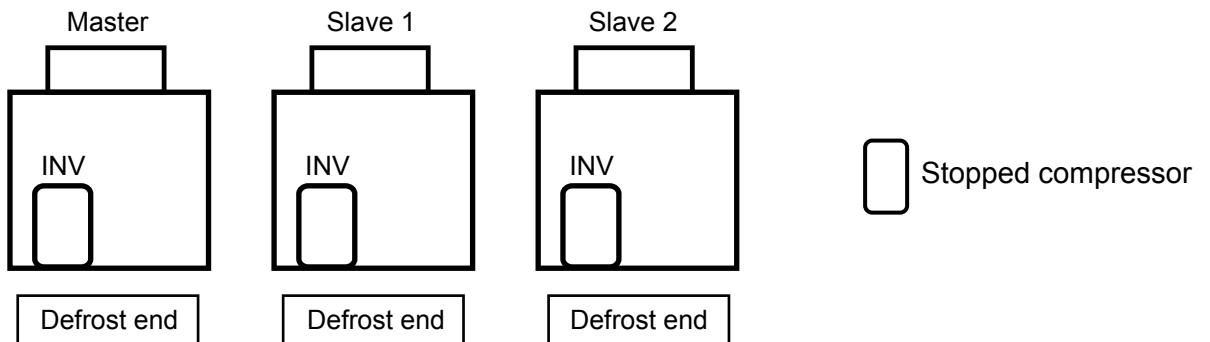

2-6 PROTECTIVE FUNCTION

2-6-1 Protective Function List

Protective Function	Detect Parts	COOL	HEAT	DISPLAY	Operating Condition	Operation
Discharge Temp Protection 1	Discharge Temp Thermistor	○		—	<p><Starting conditions> 3 minutes have elapsed since the start of operation and (discharge temperature $\geq 212^{\circ}\text{F}(100^{\circ}\text{C})$ or suction SH $\geq 50^{\circ}\text{F}(10^{\circ}\text{C})$ accumulated time 30 minutes)-</p> <p><Reset conditions> Discharge temperature $\leq 203^{\circ}\text{F}(95^{\circ}\text{C})$ and suction $\leq 45^{\circ}\text{F}(7^{\circ}\text{C})$</p>	EEV of operating indoor unit gradually opened
Discharge Temp Protection 2	Discharge Temp Thermistor	○	○	—	<p><Starting conditions> Cooling: Discharge temperature $\geq 203^{\circ}\text{F}(95^{\circ}\text{C})$ Heating: Discharge temperature $\geq 216^{\circ}\text{F}(102^{\circ}\text{C})$</p> <p><Reset conditions> Discharge temperature $< 194^{\circ}\text{F}(90^{\circ}\text{C})$ Discharge temperature $< 207^{\circ}\text{F}(97^{\circ}\text{C})$</p>	EEV2 + 30pls/30 secs
Discharge Temp Protection 3	Discharge Temp Thermistor	○		—	<p><Starting conditions> Discharge temperature $\geq 225^{\circ}\text{F}(107^{\circ}\text{C})$</p> <p><Reset conditions> Discharge temperature $\leq 221^{\circ}\text{F}(105^{\circ}\text{C})$</p>	Outdoor unit rotation execution * After rotation has been executed once; it is executed every 15 minutes.
Discharge Temp Protection 4	Discharge Temp Thermistor	○	○	—	<p>< starting condition> Discharge temperature $\geq 221^{\circ}\text{F}(105^{\circ}\text{C})$</p> <p><Pattern reset condition> Discharge temperature $\leq 212^{\circ}\text{F}(100^{\circ}\text{C})$</p>	INV compressor speed -6rps every 30 secs Speed rise prohibited, when discharge temperature becomes lower than $221^{\circ}\text{F}(105^{\circ}\text{C})$, prohibit the rotational speed rise of the compressor.
Discharge Temp Protection 5	Discharge Temp Thermistor		○	—	<p><Starting conditions> Discharge temperature $\geq 203^{\circ}\text{F}(95^{\circ}\text{C})$ and EEV1=500pls</p> <p><Reset conditions> 2 minutes have elapsed and (discharge temperature $\leq 194^{\circ}\text{F}(90^{\circ}\text{C})$ or EEV1 ≤ 400pls)</p>	Expansion valve of stopped indoor unit gradually opened (upper limit 200pls)
Discharge Temp Protection 6	Discharge Temp Thermistor		○	—	<p><Starting conditions> Discharge temperature $\geq 194^{\circ}\text{F}(90^{\circ}\text{C})$</p> <p><Reset conditions> Discharge temperature $< 194^{\circ}\text{F}(90^{\circ}\text{C})$</p>	EEV1: Forcefully OPEN
Discharge Temp Protection Stop	Discharge Temp Thermistor	○	○	P1	<p><Pattern ① starting condition> Discharge temperature \geq fixed value $230^{\circ}\text{F}(110^{\circ}\text{C})$</p> <p><Pattern ① reset condition> 3 minutes have elapsed and discharge temperature $\leq 176^{\circ}\text{F}(80^{\circ}\text{C})$</p>	Corresponding compressor stopped
				EA11 (INV)	<p><Pattern ② starting condition> Pattern ① generated 2 times within 40 minutes</p> <p><Pattern ② reset condition> Error reset (push button SW) executed after power turned on again</p>	Corresponding compressor stopped (permanent stop) Error display
High Pressure Protection 1	High Pressure Sensor	○		—	<p><Starting conditions> High-pressure $\geq 571\text{psi}(3.94\text{MPa})$</p> <p><Reset conditions> Fixed time has elapsed and high-pressure $\leq 537\text{psi}(3.70\text{MPa})$ * Fixed time when SV1: ON 180 secs, when SV2: ON 30 secs</p>	At INV independent operation: SV2 ON
High Pressure Protection 2	High Pressure Sensor		○	—	<p><Starting conditions> High-pressure $\geq 522\text{psi}(3.60\text{MPa})$</p> <p><Reset conditions> 3 minutes have elapsed and high-pressure $\leq 406\text{psi}(2.80\text{MPa})$</p>	At INV independent operation: SV2 ON When still insufficient: SV1 ON + SV2 ON
High Pressure Protection 3	High Pressure Sensor	○		—	<p><Starting conditions> Fixed time has elapsed and high-pressure $\geq 508\text{psi}(3.50\text{MPa})$ (* Fixed time at start of operation: 10 secs, after operation execution: 20 secs)</p> <p><Reset conditions> Operation (fan speed 1 step increase) complete</p>	Fan speed 1 step increase
High Pressure Protection 4	High Pressure Sensor		○	—	<p><Pattern ① starting condition> High-pressure $\geq 479\text{psi}(3.30\text{MPa})$</p> <p><Pattern ① reset condition> High-pressure $< 479\text{psi}(3.3\text{MPa})$</p>	Fan speed lowered/every 30 secs
				—	<p><Pattern ② starting condition> High-pressure $\geq 508\text{psi}(3.50\text{MPa})$</p> <p><Pattern ② reset condition> High-pressure $< 508\text{psi}(3.50\text{MPa})$</p>	Fan lowest speed (300rpm) fixed
High Pressure Protection 5	High Pressure Sensor		○	—	<p><Starting conditions> High-pressure $\geq 464\text{psi}(3.20\text{MPa})$</p> <p><Reset conditions> High-pressure $< 464\text{psi}(3.20\text{MPa})$</p>	Compressor capacity lowered/every 15 secs
Abnormal High Pressure Protection Control	High Pressure Sensor	○		—	<p><Pattern ① starting condition> High-pressure $\geq 548\text{psi}(3.78\text{MPa})$</p> <p><Pattern ① reset condition> After 25 seconds have elapsed and high-pressure $< 537\text{psi}(3.70\text{MPa})$</p>	Compressor capacity rise prohibited
				—	<p><Pattern ② starting condition> High-pressure $\geq 566\text{psi}(3.90\text{MPa})$</p> <p><Pattern ② reset condition> After 25 seconds have elapsed and high-pressure $< 548\text{psi}(3.78\text{MPa})$</p>	Compressor capacity lowered every 30 secs

Protective Function	Detect Parts	COOL	HEAT	DISPLAY	Operating Condition	Operation
High Pressure Protection Stop 1	High Pressure Sensor	○	○	P2	<p><Pattern ① starting condition> High-pressure $\geq 580\text{psi}(4.00\text{MPa})$</p> <p><Pattern ① reset condition> 5 minutes have elapsed and high-pressure $\leq 508\text{psi}(3.50\text{MPa})$</p>	All compressors in outdoor unit stopped
				EA41	<p><Pattern ② starting condition> Pattern ① generated 3 times within 60 minutes.</p> <p><Pattern ② reset condition> 10 minutes have elapsed and high-pressure $\leq 508\text{psi}(3.50\text{MPa})$</p>	All compressors in outdoor unit stopped Error display
High Pressure Protection Stop 2	Pressure Switch	○	○	P2	<p><Pattern ① starting condition> Pressure SW operated (Operated by high-pressure $\geq 609\text{psi}(4.20\text{MPa})$)</p> <p><Pattern ① reset condition> 5 minutes have elapsed and pressure SW operation reset (Reset by high-pressure $\leq 464\text{psi}(3.20\text{MPa})$)</p>	Corresponding compressor stopped
				EA42 (INV)	<p><Pattern ② starting condition> Pattern ① generated 3 times within 60 minutes.</p> <p><Pattern ② reset condition> 10 minutes have elapsed and pressure SW operation reset (Reset by high-pressure $\leq 464\text{psi}(3.20\text{MPa})$)</p>	Corresponding compressor stopped Error display
Low Pressure Protection 1	Low Pressure Sensor	○		—	<p><Starting conditions> Low-pressure $\leq 29\text{psi}(0.20\text{MPa})$</p> <p><Reset conditions> 5 minutes have elapsed and low-pressure $\geq 44\text{psi}(0.30\text{MPa})$</p>	SV1 ON
Low Pressure Protection 2	Low Pressure Sensor		○	—	<p><Starting conditions> Low-pressure $\leq 15\text{psi} (0.10\text{MPa})$</p> <p><Reset conditions> 3 minutes have elapsed and low-pressure $\geq 25\text{psi} (0.17\text{MPa})$</p>	SV1 ON
Low Pressure Protection 3	Low Pressure Sensor	○		—	<p><Starting conditions> One operating outdoor unit and INV compressor operating at 30rps and low-pressure $\leq 94\text{psi}(0.65\text{MPa})$</p> <p><Reset conditions> 5 minutes have elapsed and INV compressor operating at 40rps or faster</p>	SV1 ON
Low Pressure Protection 4	Low Pressure Sensor		○	—	<p><Starting conditions> 3 minutes have elapsed and low-pressure $\leq 94\text{psi}(0.18\text{MPa})$</p> <p><Reset conditions> 3 minutes have elapsed and low-pressure $\geq 32\text{psi}(0.22\text{MPa})$</p>	EER of stopped indoor unit opened quickly (450pls)
Abnormal Low Pressure Protection Control	Low Pressure Sensor		○	—	<p><starting condition> Low-pressure $\leq 23\text{psi}(0.16\text{MPa})$</p> <p><reset condition> 3 minutes have elapsed and low-pressure $\geq 26\text{psi} (0.18\text{MPa})$</p>	Compressor capacity lowered every 180 secs, when the Low-pressure becomes more than 25psi(0.17MPa), prohibit compressor capacity rise.
Low Pressure Protection Stop	Low Pressure Sensor	○	○	P3	<p><Pattern ① starting condition> Low-pressure $\leq 7\text{psi}(0.05\text{MPa})$ or low-pressure $\leq 15\text{psi}(0.10\text{MPa})$ continues for 10 mins</p> <p><Pattern ① reset condition> 3 minutes have elapsed and low-pressure $\geq 25\text{psi}(0.17\text{MPa})$</p>	All compressors in outdoor unit stopped
				EA51	<p><Pattern ② starting condition> Pattern ① generated 5 times within 180 minutes.</p> <p><Pattern ② reset condition> Error reset (push button SW) executed after power turned on again.</p>	All compressors in outdoor unit stopped (permanent stop) Error display
Compressor Temp Protection Stop	Compressor Temp Thermistor	○	○	P4	<p><Pattern ① starting condition> Compressor temperature \geq fixed value 234 °F(112°C)</p> <p><Pattern ① reset condition> 3 minutes have elapsed and discharge temperature ≤ 176 °F(80°C)</p>	Corresponding compressor stopped
				EA31 (INV)	<p><Pattern ② starting condition> Pattern ① generated 2 times within 40 minutes</p> <p><Pattern ② reset condition> Error reset (push button SW) executed after power turned on again</p>	Corresponding compressor stopped (permanent stop) Error display

Protective Function	Detect Parts	COOL	HEAT	DISPLAY	Operating Condition	Operation
Overcurrent Break Stop (INV compressor)	Overcurrent Protection Circuit	○	○	E941 (permanent stop)	Inverter compressor is stopped when the over current protection circuit in the inverter PC Board detects an abnormal current during the operation. If it repeated 5 times, the inverter compressor becomes permanent stop.	INV compressor stopped
				E931 (permanent stop)	Inverter compressor is stopped when the over current protection circuit in the inverter PC Board detects an abnormal current at the time of start up. Inverter compressor becomes permanent stop if it repeated over the number of set time.	
				—	<Reset condition> Error reset (push button SW) executed after power turned on again.	
Heatsink Temp Protection Stop	Heatsink Temp Thermistor	○	○	—	<Pattern ① starting condition> Heat sink temperature $\geq 190^{\circ}\text{F}(88^{\circ}\text{C})$ <Pattern ① reset condition> 3 minutes have elapsed and heat sink temperature $\leq 167^{\circ}\text{F}(75^{\circ}\text{C})$	INV compressor stopped
				EAC4	<Pattern ② starting condition> Pattern ① generated 3 times within 60 minutes. <Pattern ② reset condition> 10 minutes have elapsed and heat sink temperature $\leq 167^{\circ}\text{F}(75^{\circ}\text{C})$	INV compressor stopped Error display
Frequency Maximum Setting Protection (INV compressor)	Current Detector Circuit	○	○	—	<Pattern ① starting condition> Current value $\geq 27.5\text{A}$ <Pattern ① reset condition> Current value $< 27.5\text{A}$	INV compressor speed rise prohibited
				—	<Pattern ② starting condition> Current value $\geq 28.5\text{A}$ <Pattern ② reset condition> Current value $< 28.5\text{A}$ <div style="border: 1px solid black; padding: 2px; width: fit-content;"> • Pattern ① and ② start current value changed by outside temperature </div>	INV compressor speed lowered

AIRSTAGE™ V-II

Variable Refrigerant Flow System

3. INDOOR UNIT OPERATION CONTROL

3. INDOOR UNIT OPERATION CONTROL

3-1 FAN CONTROL

3-1-1 Fan Speed Setting

Fan speed setting



Press the FAN CONTROL button to set the fan speed.



3-1-2 "AUTO" Position

1. COOL OPERATION

The fan speed is determined automatically in accordance with the condition " T_R (corrected room temperature) - T_s (corrected set temperature)" as shown on the right.

However, the fan speed zone is determined in the manner as the room temperature increases for the following cases.

- (1) When the T_s is changed.
- (2) When the operation mode is changed from other mode to "COOL".
- (3) When the fan control is changed from other position to "AUTO".

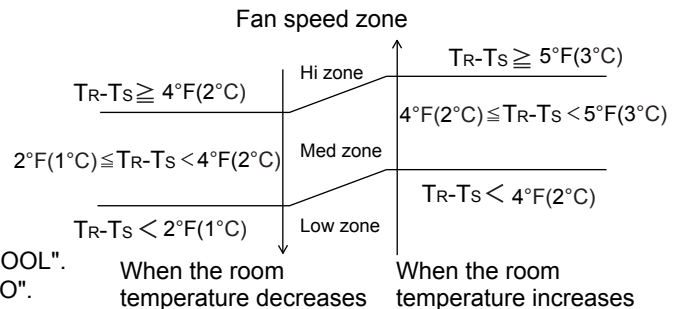

2. HEAT OPERATION

Same as Cooling operation, fan speed is decided by the difference between the room temperature and the set temperature.

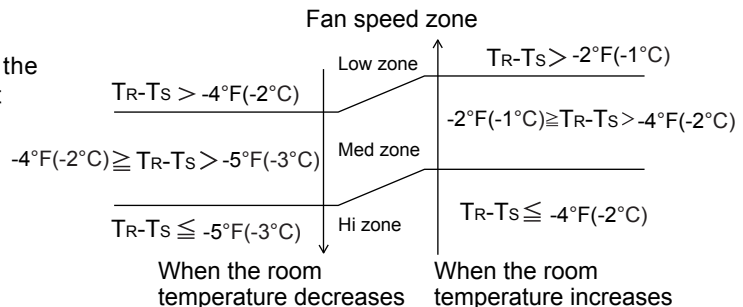

3. DRY OPERATION

The indoor fan always rotates at "Lo" speed.

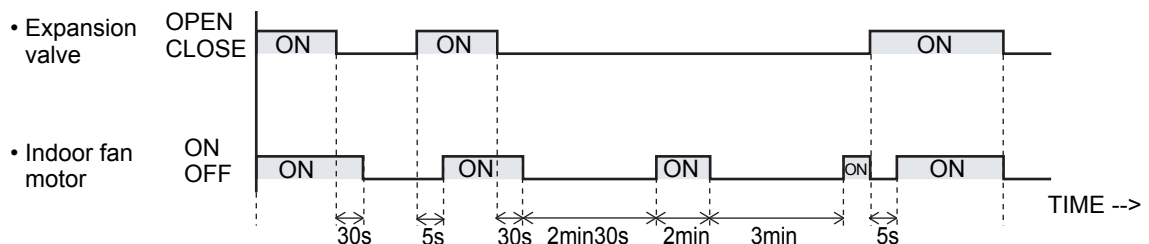

- (1) The indoor fan starts operation 5 seconds after the electric expansion valve opens. However, when the indoor unit just starts its operation or the operation mode is changed from other to "DRY" and the refrigerant circulation is not stopped, the fan will rotate immediately without a delay time of 5 seconds.
- (2) The indoor fan will stop in 30 seconds when the refrigerant circulation stops.
- (3) The indoor fan will stop immediately when the indoor unit is stopped by pushing the stop button or by a setting of ON timer.
- (4) When the refrigerant circulation is stopped due to a lower room temperature for more than 3 minutes, the fan will rotate 2 minutes at intervals of 3 minutes.
- (5) When the indoor unit just starts its operation or the operation mode is changed from other to "DRY" and the refrigerant circulation is stopped, the fan will rotate for 1 minute and then it will operate according to the statement (4).

* The above explanation may differ from the actual operating condition when the compressor is controlled under protection function.

3-2 MASTER CONTROL

3-2-1 Operation Mode Control

Each operation mode is controlled as below.

(1) Stop mode

- Indoor fan motor : OFF
- Electric expansion valve : Stop pulse
- Drain pump : Turns ON-OFF by the drain pump control function

(2) Cool, Dry and Heat Mode

	Cool	Dry	Heat
Indoor fan motor	Operates according to the AIR FLOW-MODE setting.	See the fan control page.	Operates according to the AIR FLOW-MODE setting, and besides cold air prevention operation
Drain pump	Turns ON-OFF by the drain pump control function		
Electrical expansion valve	Pulse controlled by the temperature difference calculation and frost prevent function	Pulse controlled by the temperature difference calculation and frost prevent function	Pulse controlled by the temperature difference.

(3) Priority mode

The purpose of the priority mode is to restrict operation commands (heating, cooling, dry) from the connected indoor units. There are 3 priority modes of Neutral, Cooling Priority, and Heating Priority. The operation modes restricted by each of these modes are as follows:

Priority mode	Restricted operation mode
Neutral	No restrictions
Cooling priority	Heating
Heating priority	Cooling, dry

1. Priority mode decision methods

Method 1. (Default value)

The initial priority mode is made Neutral and is shifted to Cooling Priority when cooling and to Heating Priority when heating depending on which operation mode (cooling, heating) was input first. After shifting to Cooling Priority or Heating Priority, the priority mode shifts to Neutral only when there was a Stop input from all the indoor units.

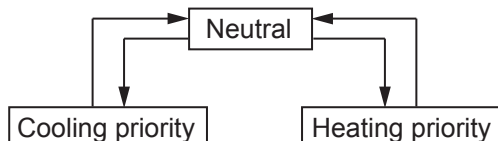

Method 2. (Management by outdoor unit)

Operation mode management is made "Management by outdoor unit" by outdoor unit PUSH-SW (field setting).

The priority mode shifts to Cooling Priority or Heating Priority in accordance with input from the outdoor unit regardless of the current mode.

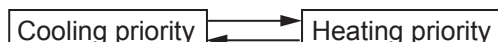

Method 3. (Management by indoor unit)

Operation mode management is made "Management by indoor unit" by outdoor unit PUSH-SW (field setting).

Then the master indoor unit is set by wired remote controller.

Thereupon the priority mode shifts to Cooling Priority or Heating Priority in accordance with input from the master indoor unit regardless of the current priority mode.

The priority mode is fixed at either cooling or heating even if the master indoor unit stops

Cooling/heating switching can be performed by the master indoor unit only.

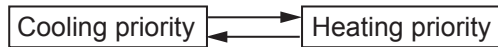

(4) Opposite operation mode

When the operation mode commanded from an indoor unit (remote controller) and the operation mode allowed by the system (cooling and dry operation for cooling only type and operation mode allowed by priority mode for heat pump type) do not match, it is indicated by blinking of an LED.

Timer lamp: 3 secs ON/1 sec OFF repeated

3-2-1 Operation Mode Control for Outdoor air unit

Each operation mode is controlled as below.

(1) Stop mode

- Outdoor air unit fan motor : OFF
- Electric expansion valve : Stop pulse
- Drain pump : Turns ON-OFF by the drain pump control function
- Solenoid valve : Closed

(2) Cool and Heat Mode

Each operation mode is controlled as below.

	Cool	Heat	Fan
Outdoor air unit fan motor	Operates according to the HIGH MODE setting.	Operates according to the HIGH MODE setting.	Operates according to the HIGH MODE setting.
Drain pump	Turns ON-OFF by the drain pump control function		
Electrical expansion valve	Pulse controlled by the temperature difference calculation and freeze prevention control	Pulse controlled by the temperature difference.	Stop pulse
Solenoid valve	Closed at all times	Opened at thermostat off and compressor on. Closed at other operation.	Closed at all times

(3) Priority mode

The purpose of the priority mode is to restrict operation commands (heating, cooling) from the connected outdoor air units. There are 3 priority modes of Neutral, Cooling Priority, and Heating Priority. The operation modes restricted by each of these modes are as follows:

Priority mode	Restricted operation mode
Neutral	No restrictions
Cooling priority	Heating
Heating priority	Cooling

1. Priority mode decision methods

Method 1. (Default value)

The initial priority mode is made Neutral and is shifted to Cooling Priority when cooling and to Heating Priority when heating depending on which operation mode (cooling, heating) was input first. After shifting to Cooling Priority or Heating Priority, the priority mode shifts to Neutral only when there was a Stop input from all the indoor units.

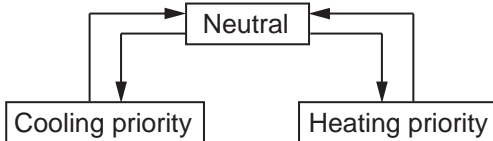

Method 2. (Management by Outdoor unit)

Operation mode management is made "Management by Outdoor unit" by Outdoor unit PUSH-SW (field setting).

The priority mode shifts to Cooling Priority or Heating Priority in accordance with input from the Outdoor unit regardless of the current mode.

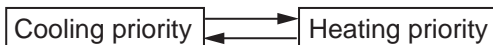

Method 3. (Management by indoor unit)

Operation mode management is made "Management by indoor unit" by Outdoor unit PUSH-SW (field setting).

Then the master indoor unit is set by wired remote controller.

Thereupon the priority mode shifts to Cooling Priority or Heating Priority in accordance with input from the master indoor unit regardless of the current priority mode.

The priority mode is fixed at either cooling or heating even if the master indoor unit stops Cooling/Heating switching can be performed by the master indoor unit only.

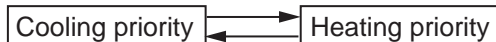

(4) Opposite operation mode

When the operation mode commanded from an indoor unit (remote controller) and the operation mode allowed by the system (cooling and dry operation for cooling only type and operation mode allowed by priority mode for heat pump type) do not match, it is indicated by blinking of an LED.

Timer lamp: 3 secs ON/1 sec OFF repeated

3-2-2 Auto Changeover

[Method]

1. Switch operation mode management to "Management by indoor unit" by outdoor unit DIP-SW.
2. Set the master indoor unit by wired remote controller.
3. Judge cooling/heating by the difference between the master indoor unit's setting temperature and the room temperature.

Auto changeover is not ideal for systems that comprise of multiple indoor units.

■ AUTO CHANGEOVER operation

Operation flow chart

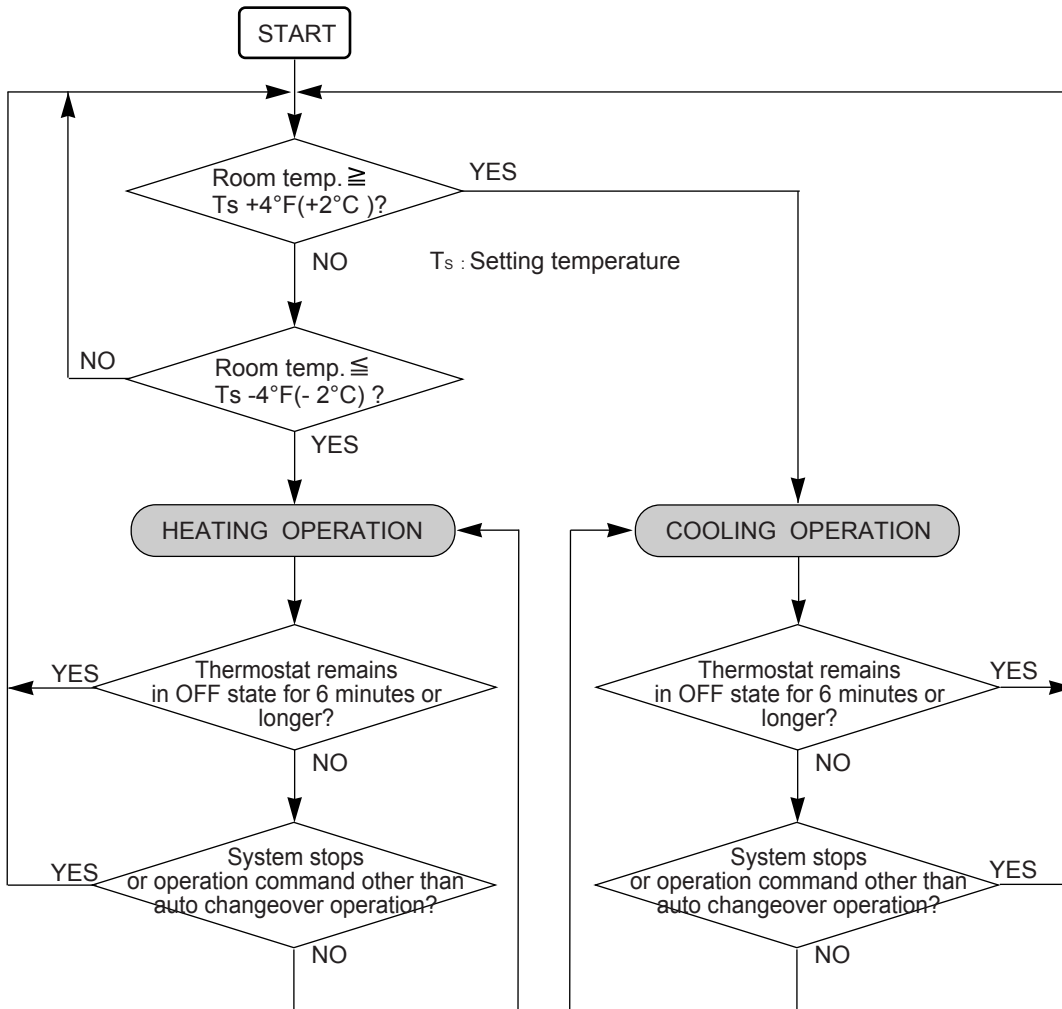

3-2-2 Auto Changeover

[Method]

1. Switch operation mode management to "Management by indoor unit" by outdoor unit DIP-SW.
2. Set the master indoor unit by wired remote controller.
3. Judge cooling/heating by the difference between the master indoor unit's setting temperature and the room temperature.

■ AUTO CHANGEOVER operation

Operation flow chart

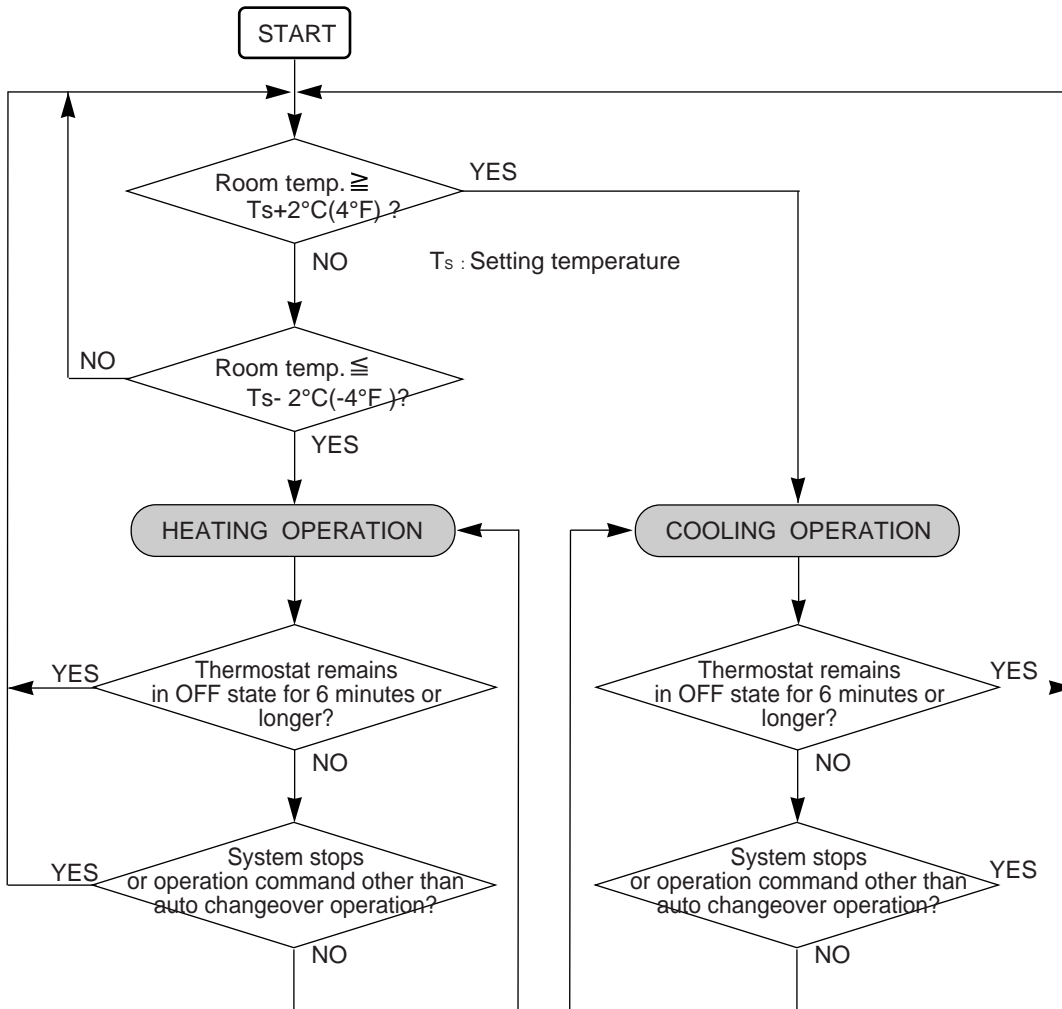

3-2-3 "COOL" Position

When using the cooling mode, set the temperature to a value lower than the current room temperature, otherwise the indoor unit will not start the cooling operation and only the fan will rotate.

An example for COOLING TEMPERATURE CONTROL time chart (Manual setting)

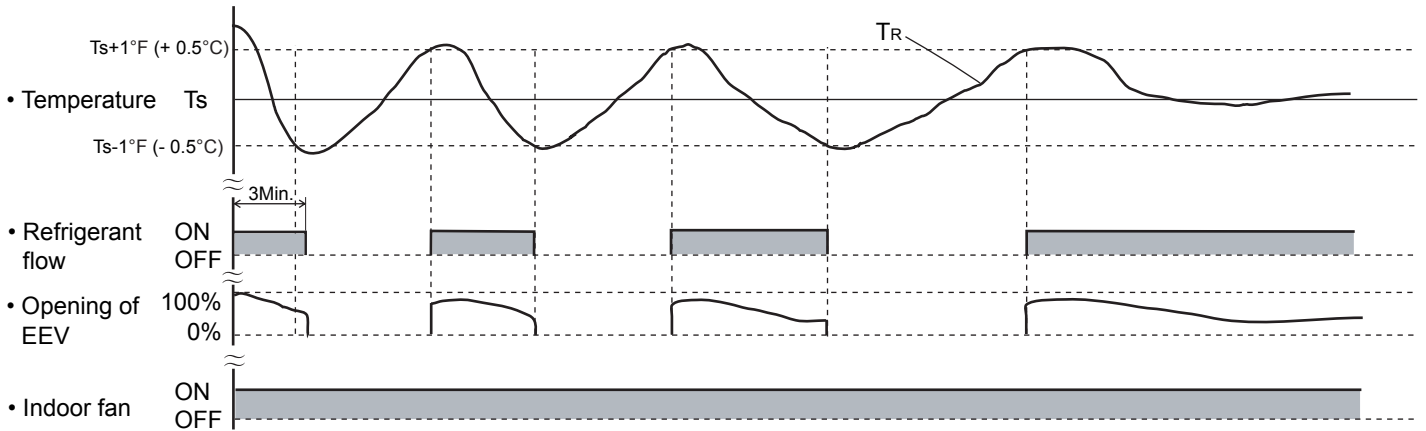

T_s : Corrected setting temperature $T_s+1^\circ\text{F} (+0.5^\circ\text{C})$: The thres hold temperature of start of refrigerant flow
 T_R : Corrected room temperature $T_s-1^\circ\text{F} (-0.5^\circ\text{C})$: The thres hold temperature of stop of refrigerant flow

3-2-4 "HEAT" Position

- (1) When using the heating mode, set the temperature to a value higher than the current room temperature, otherwise the indoor unit will not start the heating operation.
- (2) After the start of heating operation, the fan of indoor unit will not rotate until the heater exchange is warmed up to blow out warm air.
- (3) During defrosting, the OPERATION indicator lamp flashes 6 sec. ON and 2 sec. OFF, and repeat. The heating operation will be temporarily interrupted.

An example for HEATING TEMPERATURE CONTROL time chart (Manual setting)

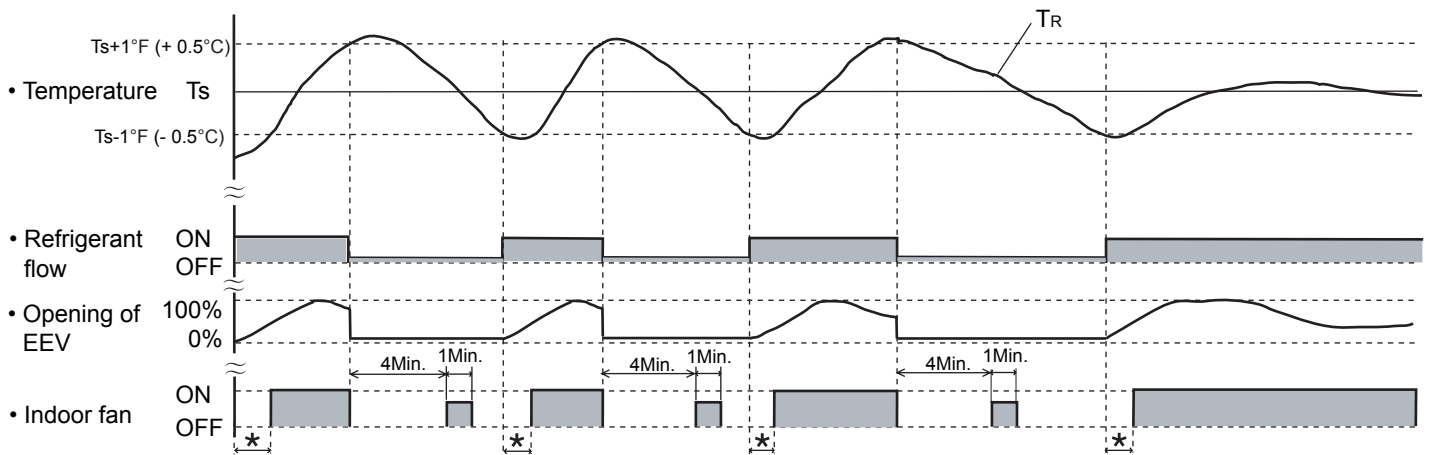

T_s : Corrected setting temperature $T_s+1^\circ\text{F} (+0.5^\circ\text{C})$: The thres hold temperature of start of refrigerant flow
 T_R : Corrected room temperature $T_s-1^\circ\text{F} (-0.5^\circ\text{C})$: The thres hold temperature of stop of refrigerant flow
 \ast : Duration of cold air prevention

3-2-4 "COOL" Position for Outdoor air unit

When using the cooling mode, set the temperature to a value lower than the discharge airflow temperature, otherwise the outdoor air unit will not start the cooling operation and only the fan will rotate.

An example for COOLING TEMPERATURE CONTROL time chart (Manual setting)

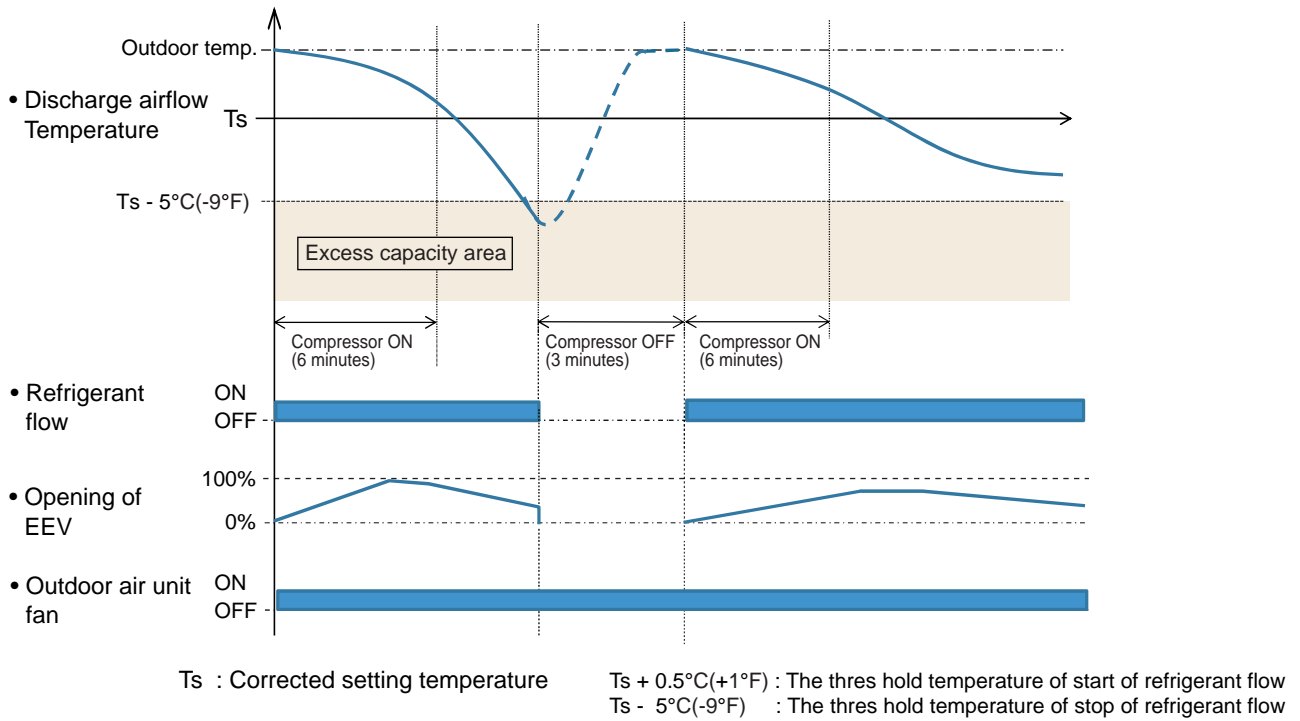

3-2-5 "HEAT" Position for Outdoor air unit

- (1) When using the heating mode, set the temperature to a value higher than the discharge airflow temperature, otherwise the outdoor air unit will not start the heating operation.
- (2) During defrosting, the OPERATION indicator lamp flashes 6 sec. ON and 2 sec. OFF, and repeat. The heating operation will be temporarily interrupted.

An example for HEATING TEMPERATURE CONTROL time chart (Manual setting)

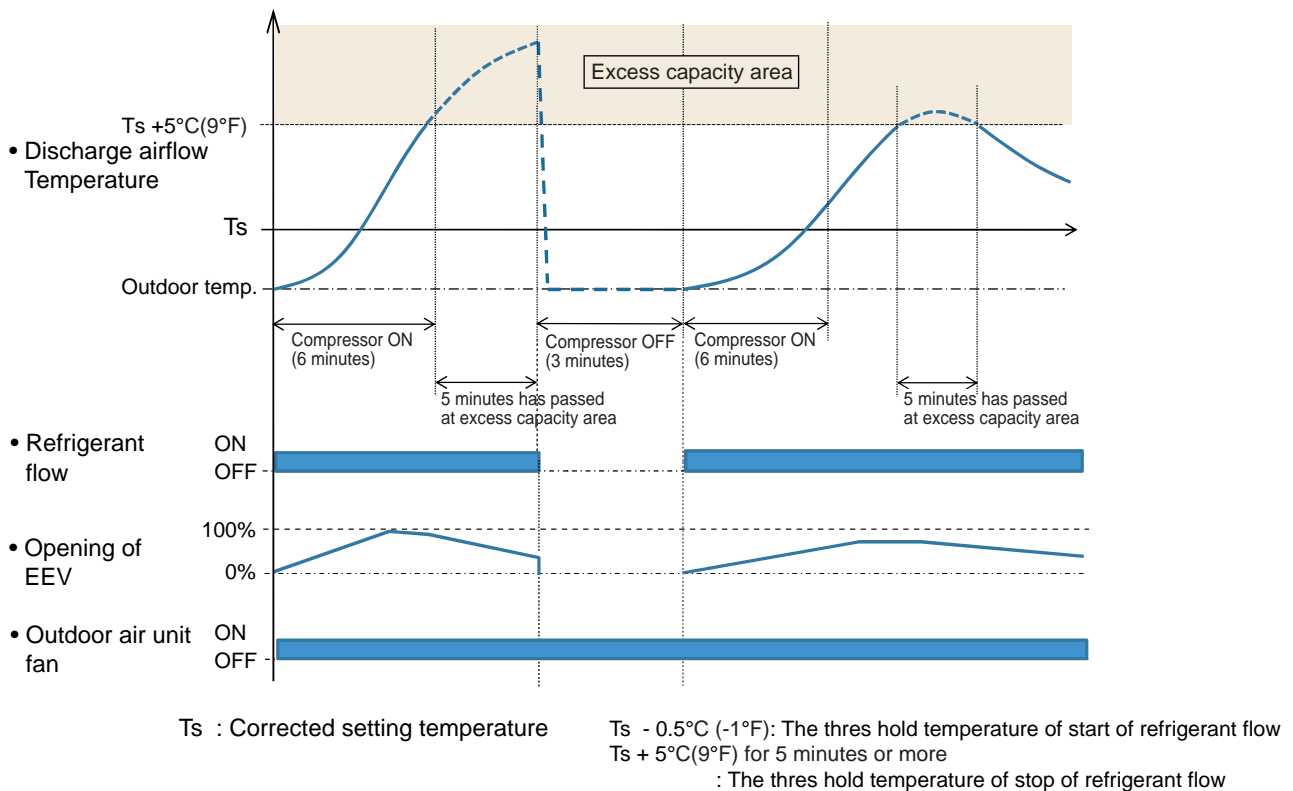

3-3 LOUVER CONTROL

(1) ADJUSTING THE DIRECTION OF AIR CIRCULATION

Instructions relating to heating (*) are applicable only to heat pump type outdoor unit.

Begin air conditioner operation before performing this procedure.

Vertical Air Direction Adjustment

This instructions are applicable to "LARGE CEILING TYPE", "UNIVERSAL FLOOR/CEILING TYPE", "CASSETTE TYPE", "WALL MOUNTED TYPE" and "COMPACT WALL MOUNTED TYPE".

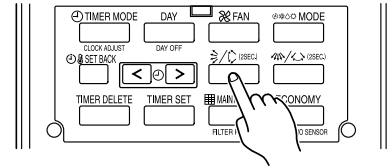

Example : When set to vertical air direction.

Press the **VERTICAL AIR FLOW DIRECTION SET** button.

- Press the VERTICAL AIRFLOW DIRECTION button.
The temperature display will change to the vertical airflow direction setting display.
- Press the VERTICAL AIRFLOW DIRECTION button to change the vertical louvre position.
The position number will appear on the display.

Cooling & Dry : ①, ②, ③, ④

Heating : ①, ②, ③, ④

■ LARGE CEILING TYPE

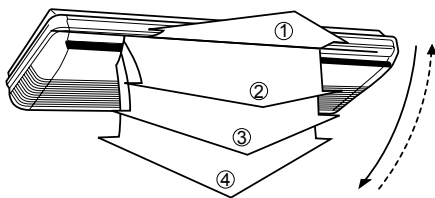

■ UNIVERSAL FLOOR/CEILING TYPE

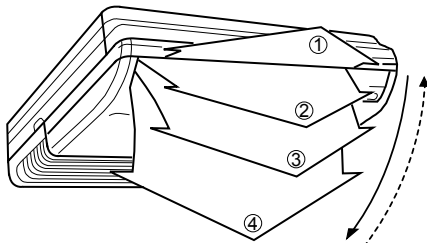

■ CASSETTE TYPE

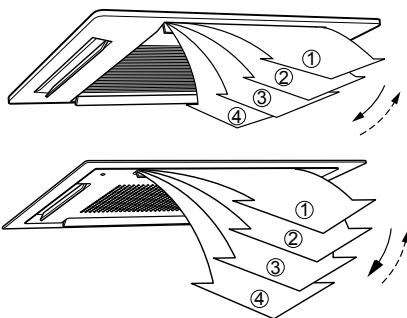

■ WALL MOUNTED TYPE

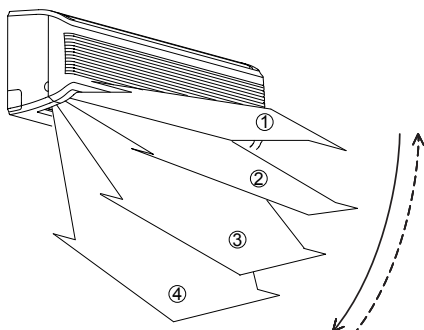

■ COMPACT WALL MOUNTED TYPE

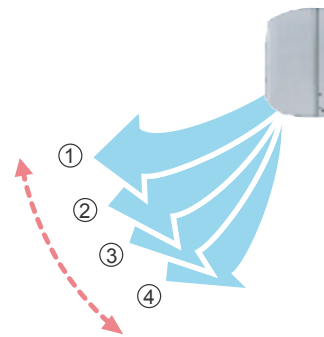

⚠ DANGER!

Never place fingers or foreign objects inside the outlet ports, since the internal fan operates at high speed and could cause personal injury.

- Always use the remote control unit's AIR FLOW DIRECTION button to adjust the UP/DOWN air direction flaps or RIGHT/LEFT air direction louvers. Attempting to move them manually could result in improper operation; in this case, stop operation and restart. The louvers should begin to operate properly again.
- When used in a room with infants, children, elderly or sick persons, the air direction and room temperature should be considered carefully when making settings.

- Use the air direction adjustments within the ranges shown above.
- The vertical airflow direction is set automatically as shown, in accordance with the type of operation selected.
During Cooling mode : Horizontal flow ①
* During Heating mode : Downward flow ④
- During AUTO mode operation, for the first minute after beginning operation, airflow will be horizontal ①, the air direction cannot be adjusted during this period.

Horizontal Air Direction Adjustment

This instructions are applicable to "LARGE CEILING TYPE", "UNIVERSAL FLOOR/CEILING TYPE" and "WALL MOUNTED TYPE".

Press the **HORIZONTAL AIR FLOW DIRECTION SET** button.

- Press the HORIZONTAL AIRFLOW DIRECTION button. The temperature display will change to the horizontal airflow direction setting display.
- Press the HORIZONTAL AIRFLOW DIRECTION button to change the horizontal louvre position. The position number will appear on the display.

Cooling & Dry : ①, ②, ③, ④, ⑤

Heating : ①, ②, ③, ④, ⑤

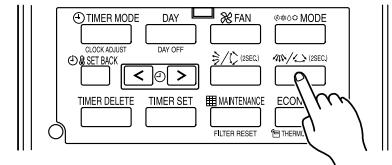

Example : When set to horizontal air direction.

■ LARGE CEILING TYPE

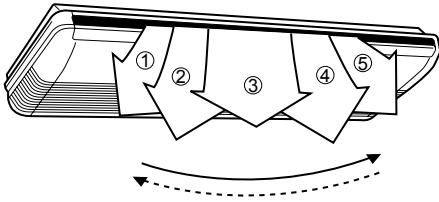

■ WALL MOUNTED TYPE

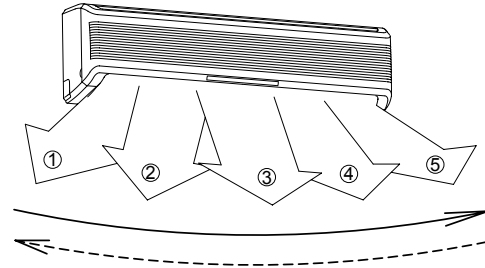

■ UNIVERSAL FLOOR/CEILING TYPE

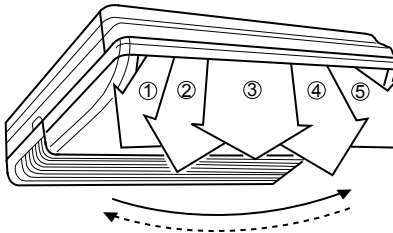

(2) SWING OPERATION

Instructions are applicable to "LARGE CEILING TYPE", "UNIVERSAL FLOOR / CEILING TYPE", "CASSETTE TYPE", "WALL MOUNTED TYPE" and "COMPACT WALL MOUNTED TYPE".

Begin air conditioner operation before performing this procedure.

To select Vertical airflow SWING Operation

This instructions are applicable to "LARGE CEILING TYPE", "UNIVERSAL FLOOR/CEILING TYPE", "CASSETTE TYPE", "WALL MOUNTED TYPE" and "COMPACT WALL MOUNTED TYPE".

Press the **VERTICAL SWING** button for more than two seconds.

The remote controller's Vertical Swing Display will light up.

In this mode, the UP/DOWN air direction flaps will swing automatically to direct the air flow both up and down.

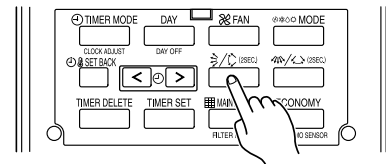

Example : When set to vertical swing.

To Stop Vertical airflow SWING Operation

Press the **VERTICAL SWING** button for more than two seconds once and again.

The remote controller's Vertical Swing Display will go out.

Airflow direction will return to the setting before swing was begun.

Instructions are applicable to "LARGE CEILING TYPE", "UNIVERSAL FLOOR / CEILING TYPE", "CASSETTE TYPE", "WALL MOUNTED TYPE", and "COMPACT WALL MOUNTED TYPE".

About Vertical Airflow SWING Operation

- The SWING operation may stop temporarily when the air conditioner's fan is not operating, or when operating at very low speeds.
- The swing operation is not available depending on the model. Please refer to the operating manual for the indoor unit.

Air swing range

Air flow direction set	Range of swing
①	① to ④ (All range)
②	
③	
④	

To select Horizontal Airflow SWING Operation

This instructions are applicable to "LARGE CEILING TYPE", "UNIVERSAL FLOOR / CEILING TYPE", "WALL MOUNTED TYPE".

Press the HORIZONTAL SWING button for more than two seconds.

The remote controller's Horizontal Swing Display will light up. In this mode, the RIGHT/LEFT air direction louvers will swing automatically to direct the airflow both right and left.

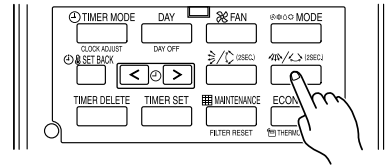

Example : When set to horizontal swing.

To stop Horizontal airflow SWING Operation

Press the HORIZONTAL SWING button for more than two seconds once and again.

The remote controller's Horizontal Swing Display will go out. Airflow direction will return to the setting before swing was begun.

About Horizontal Airflow Swing Operation

- Left and right swing range can be changed in 3 steps by field setting.
- The SWING operation may stop temporarily when the air conditioner's fan is not operating, or when operating at very low speeds.
- The swing operation is not available depending on the model. Please refer to the operating manual for the indoor unit.

Left and right swing range (◆ ... Factory setting)

Range of swing	Function Number	Setting Value
◆ ① to ⑤ (All range)	24	00
① to ③		01
③ to ⑤		02

3-4 ELECTRONIC EXPANSION VALVE CONTROL

1. Initialization

- When the power is turned ON.
- When it has passed the limited time since the last initialization.

2. Operation Control

- When indoor unit stopping

Outdoor unit Condition	EEV Condition
OFF	Fully closed
Cooling	Fully closed
Heating	Slightly open

- When starting up
(Cooling) Move to the cooling control base pulse in steps.
(Heating) Move to the heating control base pulse in steps.
- Automatic operatic control
Automatic PI control is performed based on the indoor unit heat exchanger outlet temp and inlet temp.
- Room temperature control
The room temperature is controlled so that it reaches to the set-up temperature based on the difference between the room temperature and the set-up temperature, and the change of indoor unit temperature. if the room temperature becomes 1°F (0.5°C) lower than the set-up temperature, EEV is fully closed.

3. Special Control

- Oil recovery operation : Controlled pulse.
- Test run operation : Controlled pulse.
- Icing protection control : Fully closed.
- Pump down operation : Fully open.
- Defrost operation : Controlled pulse

3-5 DRAIN PUMP OPERATION

- (1) When cooling and refrigerant circulation starts, the drain pump starts simultaneously.
- (2) The drain pump operates continuously for 3 minutes after the compressor stopped.
- (3) When the refrigent circulation is stopped by a start of indoor heat exchanger frost prevention operation, the drain pump will turn off in 1 hour after the end of indoor heat exchanger frost prevention operation.
- (4) When the water level in the drain pan rises up and then the float switch functions:
 - ① Microcomputer stops the refrigerant circulation and indoor fan motor operation.
 - ② Drain pump operates continuously for 3 minutes after the float switch is turned off.
(Almost condensing water may be drained)
- (5) When the float switch turns ON continuously for 3 minutes, 'FAILURE INDICATION' operates.
- (6) When the float switch turns OFF within 3 minutes, the unit starts cooling operation.

3-4 ELECTRONIC EXPANSION VALVE CONTROL for Outdoor air unit

1. Initialization

- When the power is turned ON.
- When it has passed the limited time since the last initialization.

2. Operation Control

- When indoor unit stopping by Thermo-OFF condition.

Outdoor unit Condition	EEV Condition
OFF	Fully closed
Cooling	Fully closed
Heating	Fully closed

- When starting up
(Cooling) Move to the cooling control base pulse in steps.
(Heating) Move to the heating control base pulse in steps.
- Automatic operatic control
Automatic PI control is performed based on the indoor unit heat exchanger outlet temp and inlet temp.
- Discharge airflow temperature control
The discharge airflow temperature is controlled so that it reaches to the set-up temperature based on the difference between the discharge airflow temperature and the set-up temperature.
Cooling operation: 1) If the discharge airflow temperature becomes 5°C lower than the set-up temperature, EEV is fully closed.
2) If the suction airflow temperature becomes 0.5°C lower than the set-up temperature, EEV is fully closed.
Heating operation: 1) If the discharge airflow temperature becomes 5°C higher than the set-up temperature for 5 minutes or more, EEV is fully closed.
2) If the suction airflow temperature becomes 0.5°C higher than the set-up temperature, EEV is fully closed.

3. Special Control

- Oil recovery operation : Controlled pulse(Maximum 1400 puls)
- Test run operation : Controlled pulse.
- Freeze prevention control : Fully closed.
- Vacuuming operation : Fully open.
- Defrost operation : Controlled pulse(Maximum 1400 puls)

3-5 DRAIN PUMP OPERATION for Outdoor air unit

- (1) When cooling and refrigerant circulation starts, the drain pump starts simultaneously.
- (2) The drain pump operates continuously for 3 minutes after the refrigerant circulation stopped.
- (3) When the refrigent circulation is stopped by a start of indoor heat exchanger frost prevention operation, the drain pump will turn off in 1 hour after the end of indoor heat exchanger frost prevention operation.
- (4) When the water level in the drain pan rises up and then the float switch functions:
 - ① Microcomputer stops the refrigerant circulation and indoor fan motor operation.
 - ② Drain pump operates continuously for 3 minutes after the float switch is turned off.
(Almost condensing water may be drained)
- (5) When the float switch turns ON continuously for 3 minutes, 'FAILURE INDICATION' operates.
- (6) When the float switch turns OFF within 3 minutes, the unit starts cooling operation.

3-6 FUNCTION

3-6-1 Auto Restart

The air conditioner restarts with the previous setting operation.

3-6-2 Icing Protection Control

The icing of the indoor heat exchanger is prevented during the cooling and dry mode operation.

(1) Starting Condition

- Compressor is operation more than 3 minutes.
When "Heat exchanger inlet temperature $\leq T_A$ " continues *4 minutes or more.
- Compressor is operation more than 3 minutes.
When "Heat exchanger outlet temperature $\leq T_A$ " continues 4 minutes or more.

(2) Operation

EEV is closed.
Fan is at the setting amount.

(3) Completing Condition

Heat exchanger inlet and middle temperature $\geq T_B$
After more than 5 minutes

* Drain pump turns off at 60 minutes past the completion of the icing protection operation.

T_A	T_B
34°F (1°C)	45°F(7°C)

3-6-3 Oil Recovery Operation

[Oil recovery operation] : It periodically returns the residual refrigerant oil in the indoor unit and the connection piping back to the outdoor unit , and prevents the compressor oil level from decreasing.

Indoor unit LED : Operation LED

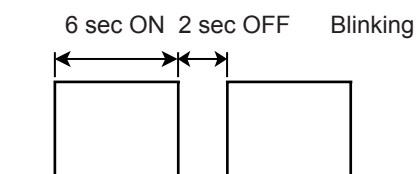

Indoor fan : Same operation before oil recovery operation.

Indoor EEV : Control pulse

* During the above operation, refrigerant noise from the indoor unit may be heard.

3-6-4 Outdoor temperature protected operation for Outdoor air unit

1. COOL OPERATION

The contents of operation is controlled as following based on the suction airflow temperature.

- a) Operation mode management is made "Management by indoor unit", and outdoor air unit is master indoor unit.

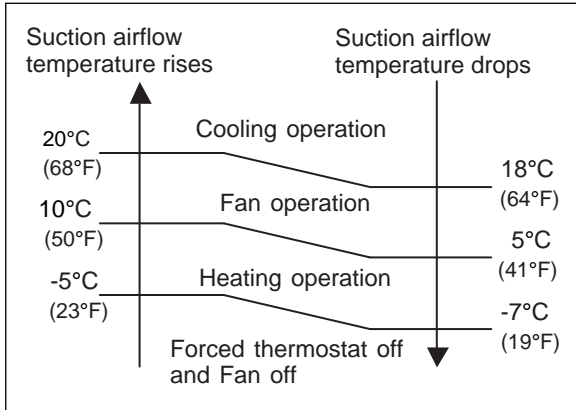

- b) Cases Other than (a)

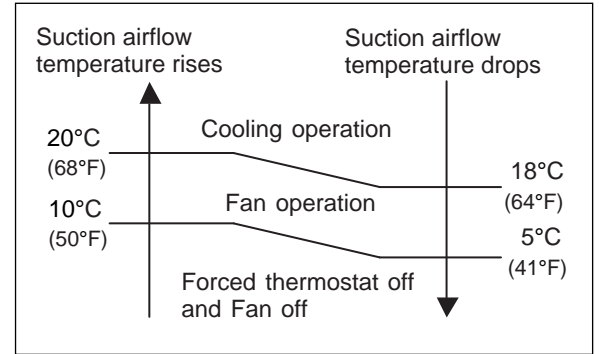

2. HEAT OPERATION

The contents of operation is controlled as following based on the suction airflow temperature.

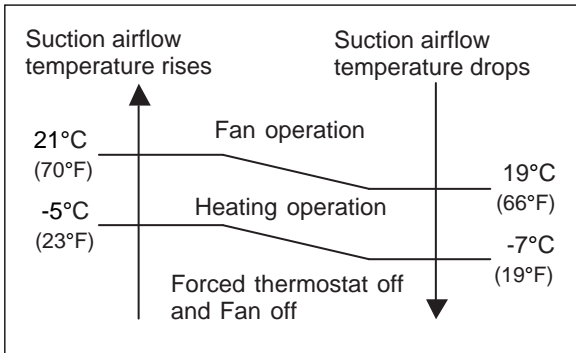

3. FAN OPERATION

The contents of operation is controlled as following based on the suction airflow temperature.

- a) Operation mode management is made "Management by indoor unit", by and outdoor air unit is master indoor unit.

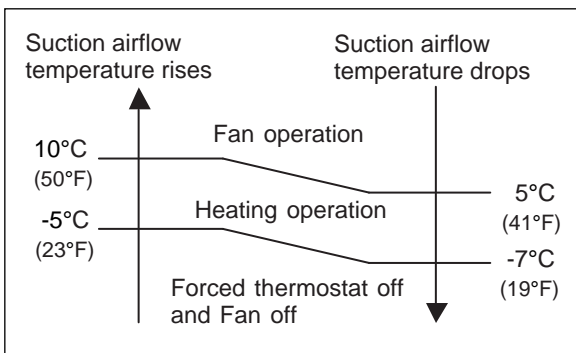

- b) Cases Other than (a)

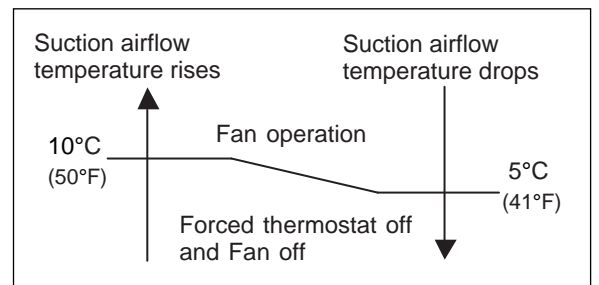

3-7 TIMER CONTROL

3-7-1 Wireless Remote Controller

UTY - LNH*

There are following 4 kinds of timer modes are available.

- ON Timer
- OFF Timer
- PROGRAM Timer
- SLEEP Timer

1. ON / OFF TIMER

The timer functions cannot be used when this controller is used together with the remote controller (Wired type).
A beeping sound is made when a signal is received.

To set the ON / OFF timer



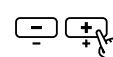
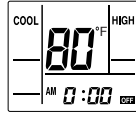

Press the START/ STOP button to start the air conditioner, and then proceed as follows.

<p>1  Press the TIMER MODE button to select "OFF TIMER" or "ON TIMER"</p> <p>→ CANCEL → OFF TIMER → ON TIMER → PROGRAM TIMER (OFF ← ON, OFF → ON) ←</p>	<p>2   Adjust the OFF or ON time. (About 5 seconds later, the entire display will reappear.)</p>
--	---

2. PROGRAM TIMER

To set the PROGRAM timer

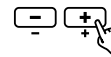
Press the START/ STOP button to start the air conditioner, and then proceed as follows.

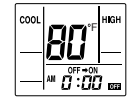
<p>1  Select "OFF TIMER"</p>	<p>2  Adjust the OFF time.</p>	<p>3  Select "ON TIMER"</p>
<p>4  Adjust the ON time. (About 5 seconds later, the entire display will reappear.)</p>	<p>5   Select "PROGRAM TIMER" (Either OFF → ON or OFF ← ON will display.) (If the ON timer has been selected to operate first, the unit will stop operating at this point.)</p>	

To cancel the TIMER

 Select "**CANCEL**".
The air conditioner will return to normal operation.

*To change operating conditions

If you wish to change the operating conditions (ON/OFF, Mode, Fan Speed, Temperature Setting), after making the time setting, wait until the entire display reappears, then press the appropriate buttons to change to the desired operating condition.

* Even ON/OFF and Sleep timer are valid.

3. SLEEP TIMER

To set the SLEEP timer

Unlike other timer functions, the **SLEEP** timer is designed to set the duration of time in which the unit does not operate. The **SLEEP** timer can be set regardless of whether the indoor unit is operating or stopped.

<p>1  (Both the indoor unit's OPERATION indicator lamp (green) and the TIMER indicator lamp (orange) will light.)</p>	<p>2   Adjust the OFF time. (About 5 seconds later, the entire display will reappear.)</p>
---	--

To change the timer settings

<p>1  Press the SLEEP button once again.</p>	<p>2  Set the time using the TIMER SET buttons.</p>
---	--

*To cancel the TIMER

 Select "**CANCEL**".
The air conditioner will return to normal operation.

*To stop air conditioner operation during timer operating



* Even ON/OFF and Program timer are valid.

- Sleep timer

The sleep timer function automatically corrects the temperature thermostat setting according to the time setting to prevent excessive cooling and heating while sleeping.

Cooling operation / dry operation

When the sleep timer is set, the set temperature automatically rises 2°F(1°C) every hour. The set temperature can rise up to a maximum of 4°F(2°C)

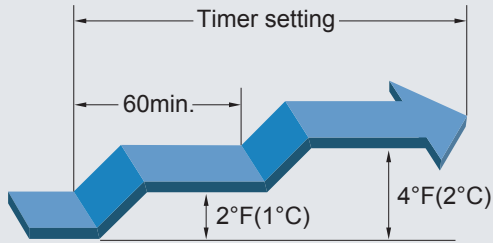

Heating operation

When the sleep timer is set, the set temperature automatically drops 2°F(1°C) every 30 minutes. The set temperature can drop to a maximum of 7°F(4°C)

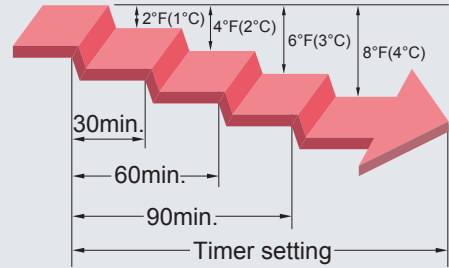

3-7-2 Wired Remote Controller



UTY - RNKU

- ON / OFF TIMER
- WEEKLY TIMER
- TEMPERATURE SET BACK TIMER





1. ON / OFF TIMER

The timer function is not available depending on the model.



To set the ON/OFF timer

1  **TIMER MODE**
 **CLOCK ADJUST**

Press the timer mode button to select the ON timer or OFF timer. It is switched every time as shown in the below diagram when the button is pressed.

No display →  →  →  → 

NON STOP **OFF TIMER** **ON TIMER** **WEEKLY TIMER**

2   

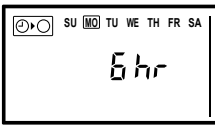

From 1 to 24 hours ex. OFF timer set for 6 hours

Press the set time buttons to set the time. After the time is set, the timer will start automatically. The amount of time until the OFF timer operates that is displayed on the timer display decreases as time passes.

● **To cancel**

 **TIMER DELETE**

- Press the DELETE button to cancel the timer mode.
- The timer mode can also be canceled by changing the timer mode using the timer mode button.

2. WEEKLY TIMER

The timer function is not available depending on the model.

Weekly timer setting

1

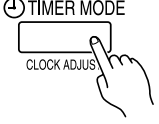
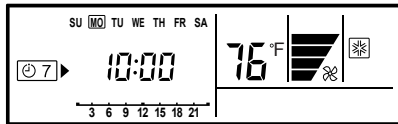
Press the timer mode button to select the weekly timer.

2

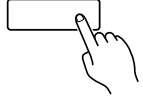

Press the SET button for 2 seconds or more.

3

Day of the week setting

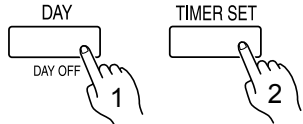

Press the DAY button to select the day of the week, and then press the TIMER SET button to confirm the setting.

* For ALL, all of the days can be set together when a appears around each day.

* ALL → SU → MO → TU → WE → TH → FR → SA

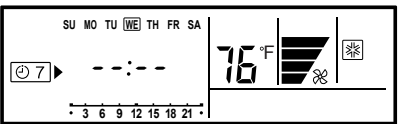

4

Time setting (ON / OFF timer)

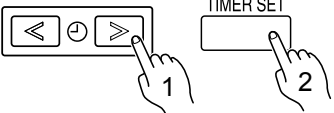

Press the SET TIME buttons to set the ON time in 30-minute increments, then press the TIMER SET button to proceed to the OFF time setting. Set the OFF time in the same way. If necessary, set the second weekly timer settings in the same way.

When the operating time is set, the  mark appears.

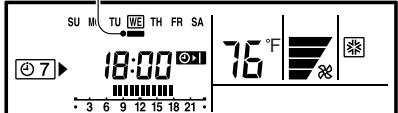

ex. The timer is set for 7:00-18:00.

Time setting (Independent OFF timer)

Switching from ON/OFF timer to independent OFF timer

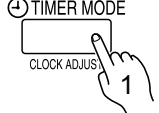

The independent timer will flash on the display.

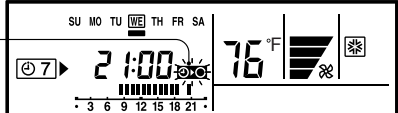

ON-2 → OFF-2 → OFF-2 → OFF-3

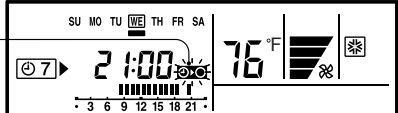

5

Repeat steps 3 and 4 to set the weekly timer for another day of the week.

6

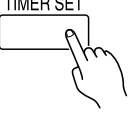

Press the TIMER SET button for 2 seconds or more to complete the weekly timer settings.

To delete the operating time



If the TIMER DELETE button is pressed during steps 3 or 4, the operating time for the selected day will be deleted. If all the days are selected, the operating times for all of the days will be deleted.

To start /cancel the WEEKLY timer operation

● To start

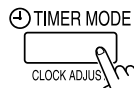

The independent timer will flash on the display.

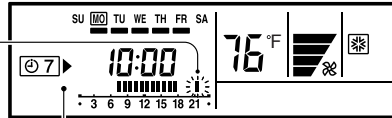

ex. Operating time 7:00-18:00
Indpnd. OFF time 21:00

When the weekly timer is selected, the timer starts automatically.

The operating time for the current day is displayed.

● To cancel

TIMER DELETE

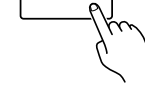

- Press the TIMER DELETE button to cancel the timer mode.
- The timer mode can also be canceled by changing the timer mode using the TIMER MODE button.

i NOTES

(1) PRECAUTIONS DURING WEEKLY TIMER SETUP

Setup is not possible in the following cases, so amend the time.

- Be sure to set the ON time first, then the OFF time. If either the ON time or the OFF time is not set correctly, the timer will not operate properly.
- The WEEKLY 2 settings cannot be set earlier than the WEEKLY 1 settings.
- The WEEKLY 1 and WEEKLY 2 time spans cannot overlap.

(2) The earliest OFF time you can set is 30 minutes after the ON time.

(3) The OFF time can be carried over to the next day.

(4) The earliest independent OFF time you can set is 30 minutes after the last OFF time.

(5) An independent OFF time can be set up to 0:00 hours of the next day.

(6) Even if the timer operation is set, the timer indicator lamp of the indoor unit does not light up. (The timer indicator lamp is used for wireless remote controllers only.)

To set the DAY OFF (for a holiday)

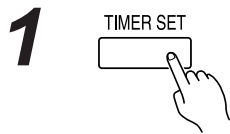

During the weekly timer, press the TIMER SET button for 2 seconds or more to set the day.

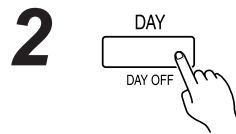

Select the day to set the DAY OFF.

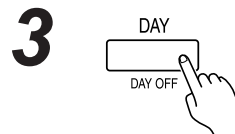

Press the DAY (DAY OFF) button for 2 seconds or more to set the DAY OFF.

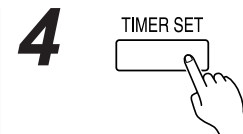

Press the TIMER SET button for 2 seconds or more to complete the DAY OFF setting.

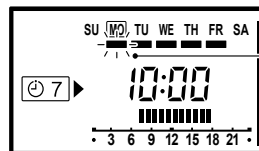
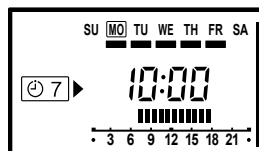

Flashing mark: indicates the DAY OFF.

ex. The DAY OFF is set for Monday.

● To cancel

Follow the same procedures as those for setup.

i NOTES

- The DAY OFF setting is only available for days for which weekly settings already exist.
- If the operating time carries over to the next day (during a next day setting), the effective DAY OFF range will be set as shown below.

● Normal

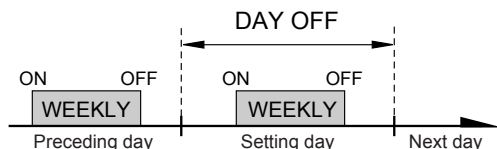

● Next day setting

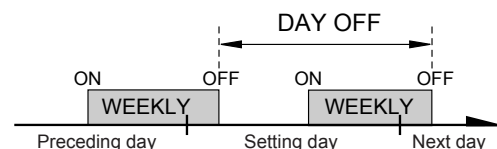

- The DAY OFF setting can only be set one time.
- The DAY OFF setting is cancelled automatically after the set day has passed.

3. TEMPERATURE SET BACK TIMER

The timer function is not available depending on the model.

Temperature SET BACK timer setting

1  SET BACK

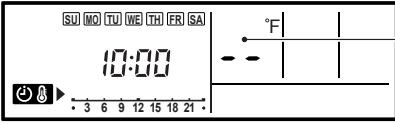

If there is no existing SET BACK temperature setting, "--" will be displayed for the temperature.

Press the SET BACK button to change to the SET BACK confirmation display. The SET BACK operating time and the set temperature will be displayed.

2  TIMER SET



Press the SET button for 2 seconds or more.

3 • Day setting • Operating time setting

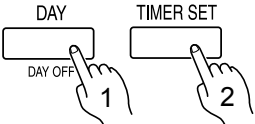
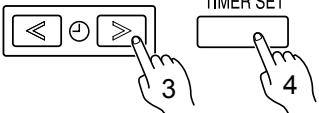

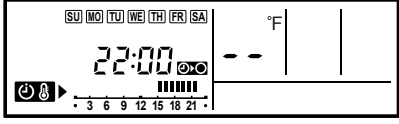

Follow step **3** and **4** in "To set the WEEKLY timer". The DELETE button is also used as described in the procedures for the weekly timer.

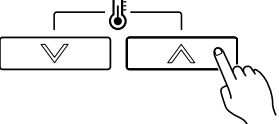
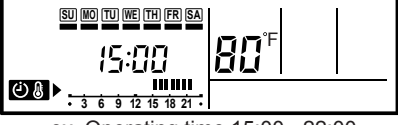

ex. When setting all days together

4 • Temperature setting



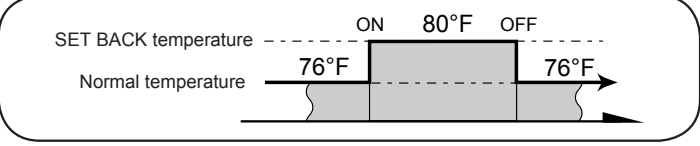

Press the set temperature buttons to set the temperature. (The temperature setting range is the same as the range for the operation mode.)

ex. Operating time 15:00 - 22:00





5  TIMER SET



Repeat steps **3** and **4**. Press the SET button for 2 seconds or more to complete the temperature SET BACK timer settings.

To start /cancel the temperature SET BACK timer operation

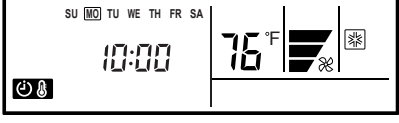

• To start

 SET BACK

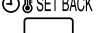

ex. Display during SET BACK timer operation (The operating time will not be displayed.)

Press the SET BACK button. The SET BACK confirmation display appears for 5 seconds, and then the timer starts automatically.

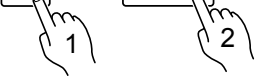
• To cancel

 SET BACK  TIMER DELETE

Press the SET BACK button, and then press the DELETE button while the SET BACK confirmation display is displayed. Even if the SET BACK button is pressed again, the SET BACK timer will be cancelled.

i NOTES

- The SET BACK timer only changes the set temperature, it cannot be used to start or stop air conditioner operation.
- The SET BACK timer can be set to operate up to two times per day but only one temperature setting can be used.
- The SET BACK timer can be used together with the ON, OFF, and weekly timer functions.
- The SET BACK operating time is displayed only in the SET BACK confirmation display. (Refer to step 1 for the SET BACK confirmation display.)
- During the COOL/DRY mode, the air conditioner will operate at a minimum of 64°F even if the SET BACK temperature is set to 63°F or lower.
- Room temperatures as low as 48°F to 58°F cannot be set depending on the model.



AIRSTAGE™ V-II

Variable Refrigerant Flow System

4. TROUBLE SHOOTING



















4. TROUBLESHOOTING

4-1 NORMAL OPERATION

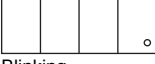
4-1-1 Indoor Unit Display

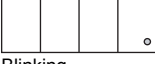
Indication type	Indication Lamp	Flashing Pattern
Operation	Operation LED	Continuous lighting
Anti Freeze		Continuous lighting(lowered light)
Timer	Timer LED	Continuous lighting(lowered light)
Filter	Filter LED	Continuous lighting
Power Failure	Operation LED	
	Timer LED	
Test Operation	Operation LED	
	Timer LED	
Defrosting	Operation LED	
Oil Recovery		
Opposite Operation Mode	Timer LED	
Maintenance Mode	Operation LED	
	Timer LED	
	Filter LED	

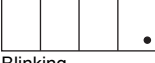
4-1-2 OUTDOOR UNIT DISPLAY

Indication type	7 Segment LED Pattern	Description
Idling(stop)	 Blank	
Cooling Mode	 "C" OO "L"	
Heating Mode	 "H" EA "T"	
Oil Recovery Operation	 "O" IL "R" ECOVERY	Refer to 02-10 page for operation.
Defrost Operation	 "D" E "F" ROST	Refer to 02-11 page for operation.
Discharge Temp. Protection is stopped	 "P" ROTECT "1"	<Starting condition> Discharge temp \geq fixed value 230°F(110°C) <Release condition> 3 minutes have elapsed and discharge temperature \leq 176°F (80°C)
High Pressure Protection is stopped	 "P" ROTECT "2"	<Starting condition> High pressure \geq 580psi (4.00MPa) <Release condition> 5 minutes have elapsed and high pressure \leq 508psi (3.50MPa)
Low Pressure Protection is stopped	 "P" ROTECT "3"	<Starting condition> Low pressure \leq 7psi (0.05MPa) or low pressure \leq 15psi (0.10MPa) continues for 10 mins <Release condition> 3 minutes have elapsed and low pressure \geq 25psi (0.17MPa)
Compressor Temperature Protection is stopped	 "P" ROTECT "4"	<Starting condition> Compressor temp \geq fixed value 234°F (112°C) <Release condition> 3 minutes have elapsed and discharge temperature \leq 176°F(80°C)
Peak Cut Mode	 "P" eak "C" ut	
Low Noise Mode	 "L" OW "N" OISE	Refer to 02-08 page for operation.
Snow Falling Protection Fan mode	 "SN" OW	Refer to 02-09 page for operation.
Inverter Compressor Operation Indication	 Blinking	ON  OFF
Constant Speed Compressor Operation Indication	 Blinking	ON  OFF
Inverter Compressor and Constant Speed Compressor Operation Indication	 Blinking	ON  OFF

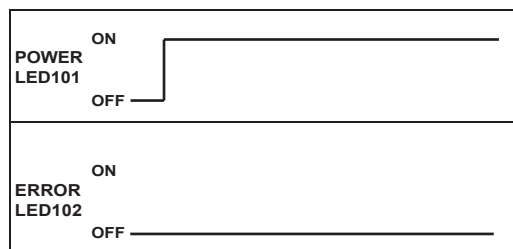
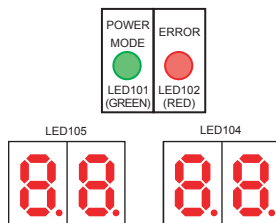

4-2 ABNORMAL OPERATION

4-2-1 Indoor Unit Display

Please refer the flashing pattern as follows.

Error Contents	Operation LED	Timer LED	Filter LED	Trouble shooting
Remote Controller Communication Error	1 times flash	2 times flash	Continuous flash	9,10
Network Communication Error	1 times flash	4 times flash	Continuous flash	12
Indoor Unit Parallel Communication Error	1 times flash	6 times flash	Continuous flash	11
Address setting Error	2 times flash	6 times flash	Continuous flash	89,90
Connection Unit Number Error in Wired Remote Controller System	2 times flash	9 times flash	Continuous flash	91,92
Indoor Unit Power Frequency Abnormal	3 times flash	1 times flash	Continuous flash	2
Indoor Unit Main PCB Error	3 times flash	2 times flash	Continuous flash	1,3
Indoor Unit Power Supply Error For Fan Motor 1	3 times flash	9 times flash	Continuous flash	83
Indoor Unit Power Supply Error For Fan Motor 2			Continuous flash	83
Indoor Unit Power Supply Error Of AC24V System			Continuous flash	88
Indoor Unit Communication circuit (WRC) Error	3 times flash	10 times flash	Continuous flash	93
Room Temperature Sensor Error	4 times flash	1 times flash	Continuous flash	4
Indoor Unit Heat Ex. Sensor Error	4 times flash	2 times flash	Continuous flash	5,6
Indoor Unit Suction Air Temp. Thermistor Error	4 times flash	10 times flash	Continuous flash	84
Indoor Unit Discharge Air Temp. Thermistor Error			Continuous flash	85
Indoor Unit Fan Motor Error	5 times flash	1 times flash	Continuous flash	8
Indoor Unit Coil (EEV) Error	5 times flash	2 times flash	Continuous flash	94
Water Drain Abnormal	5 times flash	3 times flash	Continuous flash	7
Indoor Unit Fan Motor 2 Rotation Error	5 times flash	9 times flash	Continuous flash	86
Outdoor Unit Error	9 times flash	15 times flash	Continuous flash	13 ~ 55

Depending on contents of Outdoor unit, it may not indicate. (Refer to "TROUBLE LEVEL OF SYSTEM")

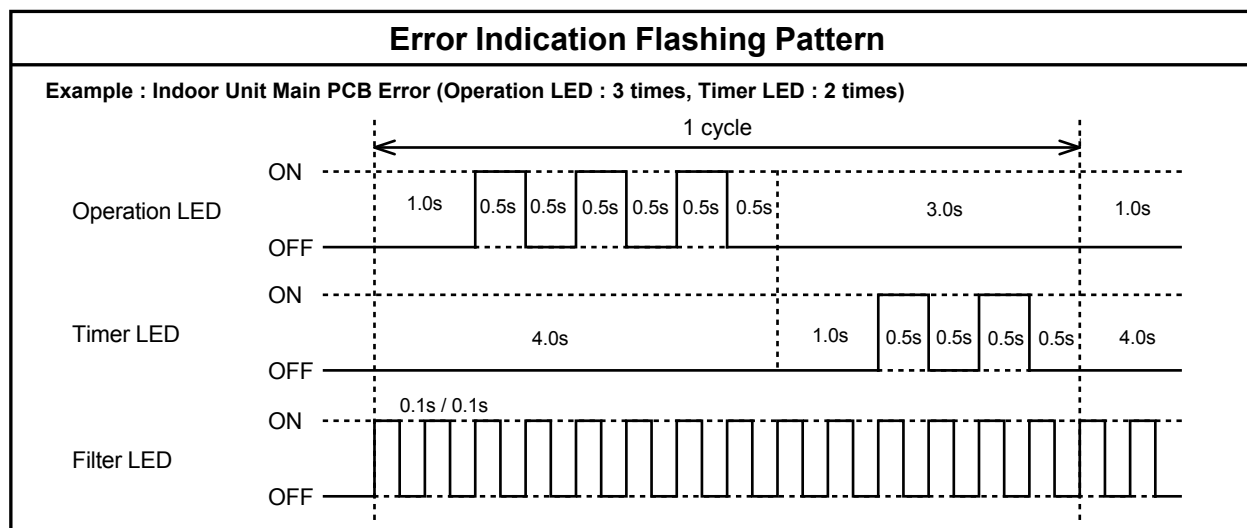

* LED Display when Option receiver unit installed.

4-2-2 Outdoor Unit Display

LED display

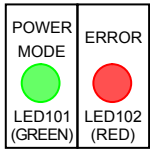

POWER MODE LED : on
ERROR LED : blink

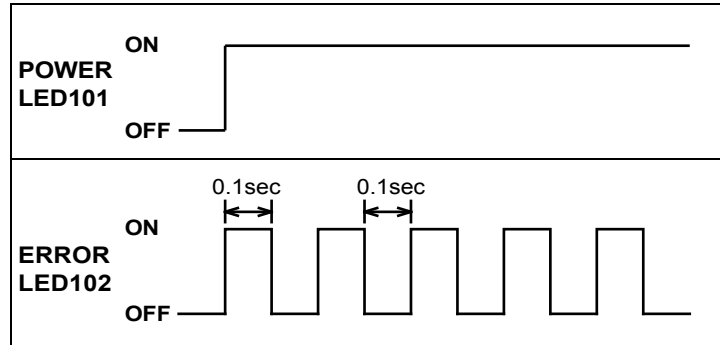

Operation button

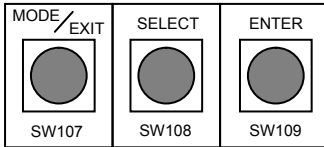

ERROR transition

Short press : less than 3 seconds
Long press : more than 3 seconds

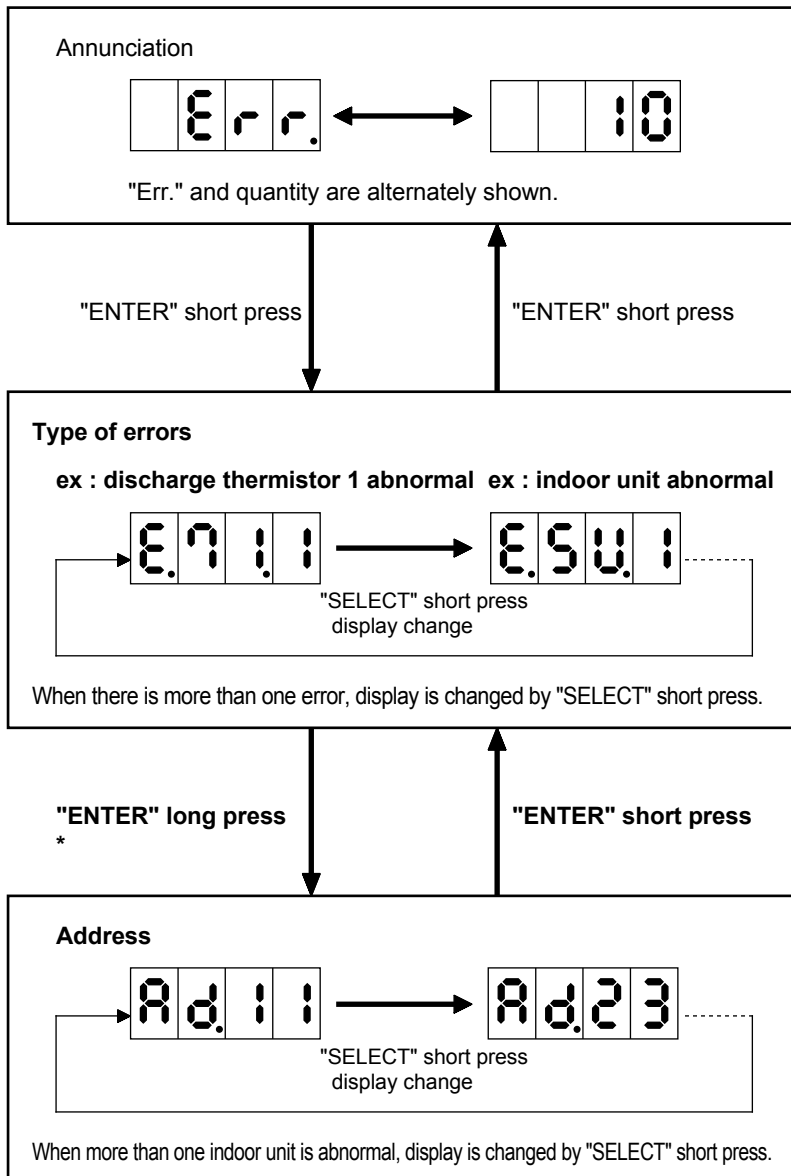

If some error is newly occurred or resolved during transition, it is reflected after going back to "Annunciation".

* Only in the case of "indoor unit abnormal (E.5U.1)", indoor unit address is shown by ENTER long press.

4-2-3 Error Code List for Outdoor Unit

Error Code	Error Contents	Trouble shooting
- - - -	Initial Setting Error	13
1 3 . 1	Communication Error Between Outdoor Unit	14
1 4 . 1	Outdoor Unit Network communication 1 Error	15
1 4 . 2	Outdoor Unit Network communication 2 Error	16
1 4 . 5	Indoor unit number shortage	17
2 8 . 1	Auto Address Setting Error	18
2 8 . 4	Signal Amplifier Auto Address Setting Error	19
5 U . 1	Indoor Unit Error	1~12.83~86 88~94
6 1 . 5	Outdoor Unit Reverse Phase Wire Error	20
6 2 . 3	Outdoor Unit EEPROM Access Error	21
6 2 . 6	Inverter Communication Error	22
6 2 . 8	Outdoor Unit EEPROM Data Error	23
6 3 . 1	Inverter Error	24
6 7 . 2	Inverter PCB Momentary Power Failure Detection	25
6 8 . 2	Rush Current Limiting Resistor Temp Rise Protection	26
6 9 . 1	Outdoor Unit Communication PCB Parallel Communication Error	27
7 1 . 1	Discharge Temp Sensor 1 Error	28
7 2 . 1	Compressor Temp Sensor 1 Error	29
7 3 . 3	Outdoor Unit Heat Ex. Liquid Temp. Sensor Error	30
7 4 . 1	Outdoor Temp Sensor Error	31
7 5 . 1	Suction Gas Temp Sensor Error	32
7 7 . 1	Heat Sink Temp Sensor Error	33
8 2 . 1	Sub-cool Heat Ex. Gas Inlet Temp. Sensor Error	34
8 2 . 2	Sub-cool Heat Ex. Gas Outlet Temp. Sensor Error	35
8 3 . 1	Liquid Pipe Temp. Sensor 1 Error	36
8 3 . 2	Liquid Pipe Temp. Sensor 2 Error	37
8 4 . 1	Current Sensor 1 Error	38
8 6 . 1	Discharge Pressure Sensor Error	39
8 6 . 3	Suction Pressure Sensor Error	40
8 6 . 4	High Pressure Switch 1 Error	41

Error Code	Error Contents	Trouble shooting
9 3 . 1	Inverter Compressor Start Up Error	42
9 4 . 1	Trip Detection	43
9 5 . 5	Compressor Motor Loss of Synchronization	44
9 7 . 1	Outdoor Unit Fan Motor Lock Error	45
9 7 . 4	Outdoor Unit Fan Motor Undervoltage	46
9 7 . 5	Outdoor Unit Fan Motor Temperature Abnormal	47
9 A . 1	Coil (Expansion Valve 1)Error	48
9 A . 2	Coil (Expansion Valve 2)Error	48
9 U . 2	Slave Unit Error	49
A 1 . 1	Discharge Temperature 1 Abnormal	50
A 3 . 1	Compressor 1 Temperature Abnormal	51
A 4 . 1	High Pressure Abnormal	52
A 4 . 2	High Pressure Protection 1	53
A 5 . 1	Low Pressure Abnormal	54
A C . 4	Heat Sink Temperature Abnormal	55

4-2-4 Remote Controller Display

<< SIMPLE REMOTE CONTROLLER >>

ERROR CODE DISPLAY

If an error occurs, the following display will be shown.
("Er" will appear in the set room temperature display.)
If "Er" is displayed, immediately contact authorized service personnel.

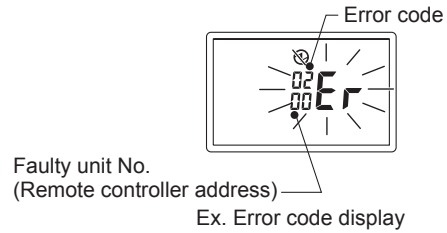

<< WIRED REMOTE CONTROLLER >>

ERROR CODE DISPLAY

If an error occurs, the following display will be shown.
("Er" will appear in the set room temperature display.)
If "Er" is displayed, immediately contact authorized service personnel.

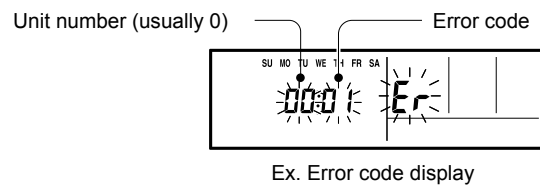

4-2-5 Error Code List for Simple and Wired Remote Controller

Error Code	Error Contents	Trouble shooting
1 2	Remote Controller Communication Error	9, 10, 80
1 4	Network Communication Error	12
1 5	Incompatible indoor unit is connected	81
1 6	Indoor Unit Parallel Communication Error	11
2 6	Address Setting Error	89, 90
2 9	Connection Unit Number Error in Wired Remote Controller System	91, 92
3 1	Indoor Unit Power Frequency Abnormal	2
3 2	Indoor Unit Main PCB Error	1, 3
3 9	Indoor unit power supply circuit Error	83, 88

Error Code	Error Contents	Trouble shooting
3 A	Indoor unit communication circuit (WRC) Error	93
4 1	Room Temperature Sensor Error	4
4 2	Indoor Unit Heat Ex. Sensor Error	5, 6
4 A	Indoor unit air temp.thermistor Error	84, 85
5 1	Indoor Unit Fan Motor Error	8
5 2	Indoor unit Coil (EEV) Error	94
5 3	Water Drain Abnormal	7
5 9	Indoor unit fan motor 2 Rotation Error	86
9 U	Outdoor Unit Error	13~ 55

4-2-6 Trouble shooting index - No Error code / Option products -

	Error condition	Error Contents	Trouble shooting
No Error Code System Abnormal	Indoor Unit - No Power	Indoor Unit - No Power	56
	Outdoor unit - No Power	Outdoor unit - No Power	57
	No operation (Power is ON)	No operation (Power is ON)	58
	No Cooling	No Cooling	59
	Abnoemal Noise	Abnormal Noise	60
	Water leaking	Water leaking	61
External SW controller Abnormal	LED does not light up	Power supply Error	62
	LED flashing 0.5sec ON and OFF	The abnormality in connection of remote controller cable	63
	LED flashing 0.5sec On and 1.0sec OFF	Transmission Error	64
	SW1,SW2 does not operate	Switch Operation Error	65
	No Error display	Power supply Error	66
	Communication Error without Error indication	Communication Error	67
Signal Amplifier Abnormal	Error code 2 6	Address Setting Error	68
	Error code C 1	Parallel Communication Error	69
	Error code D 9	Communication Error in B network	70
	Error code D 14	Communication Error in A network	71
Network converter Abnormal	No Error Display	Power supply Error	72
	Error code C 1	PCB Error 1	73
	Error code 1 2	Communication Error with Standard Remote controller	74
	Error code 1 6	Communication Error with Indoor unit	75
	Error code 2 6	Communication Error with Indoor unit	76
	Error code C A	Software Error	77
	Error code 5 U	Error on Indoor unit / Out door unit	78
Wired Remote Abnormal	Thermostat Sensor indication Flashing	Thermo sensor Error	79
	Error code 1 2	Indoor - Remote controller communication Error	80
	Error code 1 5	Incompatible Indoor unit connected	81
System Controller Service / Web Monitoring Tool	Scanning failure*	Scanning failure (Unit not detected)	82

* Other Error information or Trouble shooting, see the original reference manual separately.

4-2-7 TROUBLE LEVEL OF SYSTEM

<< System Condition when Outdoor Unit Error is occurred >>

System Condition	Outdoor unit Condition		Trouble Level	
			1	2
			(1) Not indicated on Indoor Unit. Not indicated on Peripheral Unit. Indicated on Service Tool.	(2) ● Indicated on Indoor Unit. Indicated on Peripheral. Indicated on Service Tool.
System is not stopped compulsorily.	>Abnormal >LED indication >Outdoor unit does not stop	Operation continues. (Only the subject unit stops)	>Temporary blackout detection protection (Inverter compressor stop) >Outdoor network communication abnormal 1 >Indoor unit number shortage	<ul style="list-style-type: none"> ○ Discharge temperature 1 abnormal (Inverter compressor stops) ○ Compressor 1 temperature abnormal (Inverter compressor stops) ○ High pressure switch 1 error (Inverter compressor stops) ○ Discharge Temp sensor 1 error (Inverter compressor stops) ○ liquid pipe Temp sensor 1 Error liquid pipe Temp sensor 2 Error ○ Suction gas Temp sensor error ○ Outdoor Temp sensor error ○ Sub-cool heat Ex. gas inlet Temp sensor error ○ Sub-cool heat Ex. gas outlet Temp sensor error ○ Compressor Temp sensor 1 error (Inverter compressor stop) ○ Heat sink Temp sensor error (Inverter compressor stop) ○ Current sensor error (Inverter compressor stop) ○ High pressure switch 1 error (Inverter compressor stop) ○ Inverter error (Inverter compressor stop) ○ Heat sink temperature abnormal (Inverter compressor stop) ○ Inverter compressor start up error (Inverter compressor stop) ○ Trip detection (Inverter compressor stops) ○ Rush current limiting resistor Temp rise protection (Inverter compressor stop) ○ Comp. motor loss of synchronization (Inverter compressor stop) ○ Inverter communication error (Inverter compressor stop) <p>Outdoor unit EEPROM access error Outdoor unit EEPROM data corrupted</p>
	>Abnormal >LED indication >Outdoor unit stops >Recoverable >Operation continuable	Only the subject unit stops	(Not available)	(Not available)

- This will not be displayed on indoor unit which Error Report Target(function setting 47 of indoor unit) is set "for administrator".
- System will shut down when all compressors are in abnormal stop due to some sort of defect.

System Condition	Outdoor unit Condition		Trouble Level	
			1	2
			(1) Not indicated on Indoor Unit. Not indicated on Peripheral Unit. Indicated on Service Tool.	(2) Indicated on Indoor Unit. Indicated on Peripheral. Indicated on Service Tool.
System is compulsorily stopped.	>Abnormal >LED indication >Outdoor unit stops >Recoverable >Operation continuable	Subject refrigerant circuit stops	(Not available)	(Not available)
	>Abnormal >LED indication >Outdoor unit stops >Not recoverable >Need to repair >secondary accident is possible.	Subject refrigerant circuit stops	(Not available)	>High pressure abnormal >Low pressure abnormal >Fan motor lock error >Fan motor temperature abnormal >Heat Ex. liquid Temp sensor error >Discharge pressure sensor error >Suction pressure sensor error >Outdoor unit communication PCB parallel communication error >Outdoor unit network communication 2 error >Outdoor unit reverse phase, Missing phase wire error >Outdoor unit fan motor undervoltage >Communication error between outdoor unit

<Important>

Even if power is reset, the following Error cannot release.

- Discharge temperature 1 abnormal
- Compressor 1 temperature abnormal
- Current sensor error
- Inverter compressor start up error
- Trip detection
- Rush current limiting resistor Temp rise protection
- Comp. motor loss of synchronization
- Low pressure abnormal
- Fan motor lock error

These errors can not be judged without operating the system, and the serviceman would not be able to check it if the system power is turned off before visiting the site for repair. In Error release, you need to operate push switch and apply "Error reset" (F3-40) after power restart.

4-2-8 ERROR HISTORY MODE

When an abnormality occurs, the system memorizes the history of error codes up to 10 and it can be displayed on 7 segments LED.

It is an effective means to examine abnormality that occurred in the past

*The error history can be cleared by setting to F3-30.

Refer to the following for the procedure.

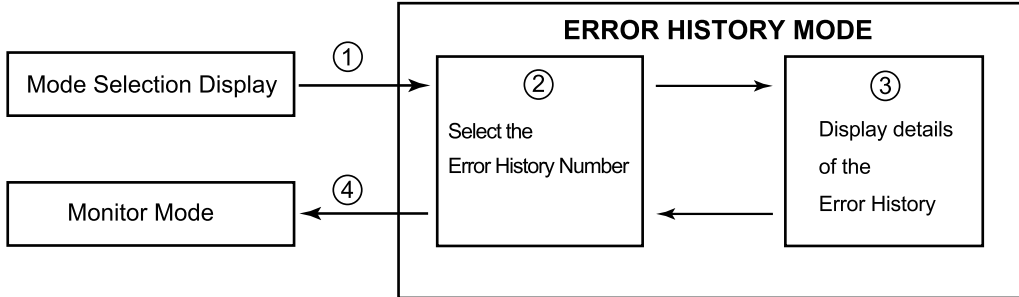

① Change to the Error History Mode from the Mode Selection Display

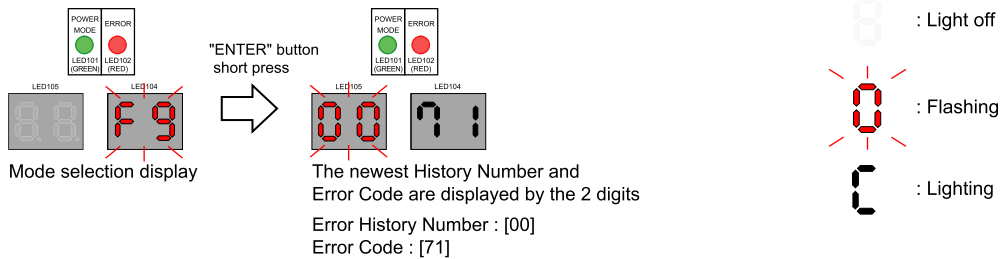

② Select the Error History Number

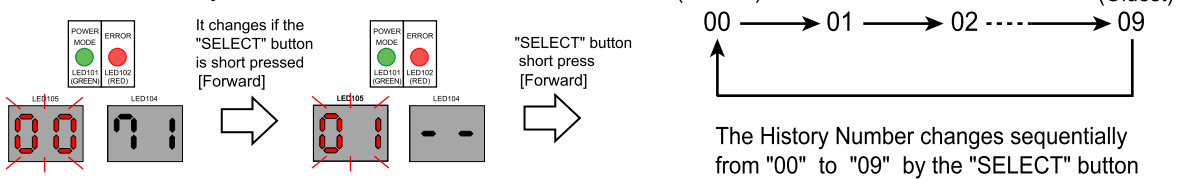

③ Check the detail of the Error History

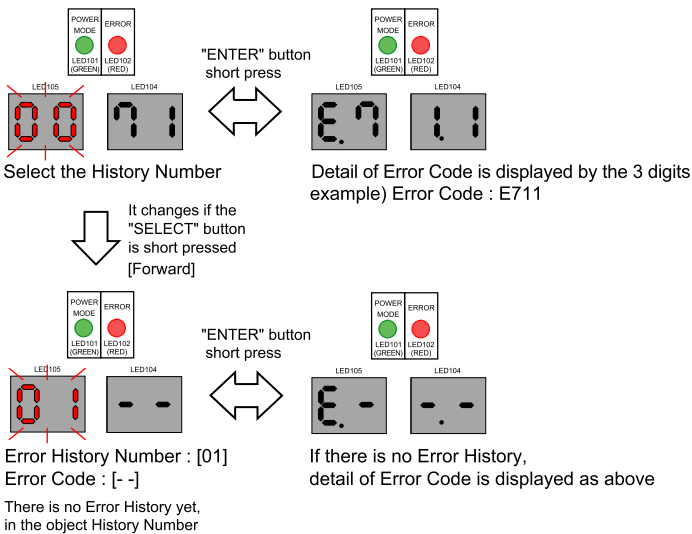

④ End of the Error History mode

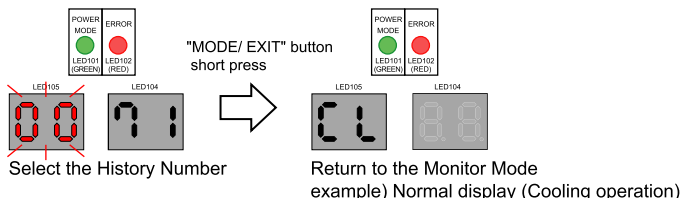

4-3 TROUBLE SHOOTING

4-3-1 Trouble shooting with error code (INDOOR UNIT)

Trouble shooting 1 INDOOR UNIT Error Method: Model Information Error (Indoor Unit Main PCB Error)	Indicate or Display: Outdoor Unit : E.5 U.1 Indoor Unit : Operation LED 3 times Flash, Timer LED 2 Times Flash, Filter LED Continuous Flash. Error Code : 3 2
--	--

Detective Actuators: Indoor Unit Controller PCB Circuit	Detective details: 3 continuous failure of lead test of EEPROM at Power ON, or Apparent Model information error from EEPROM. Also, Error on Model information upon model information test of EEPROM, or Model information of EEPROM not possible to recover.
---	--

Forecast of Cause : 1. Outside cause 2. Connection failure of electric components 3. Controller PCB defective

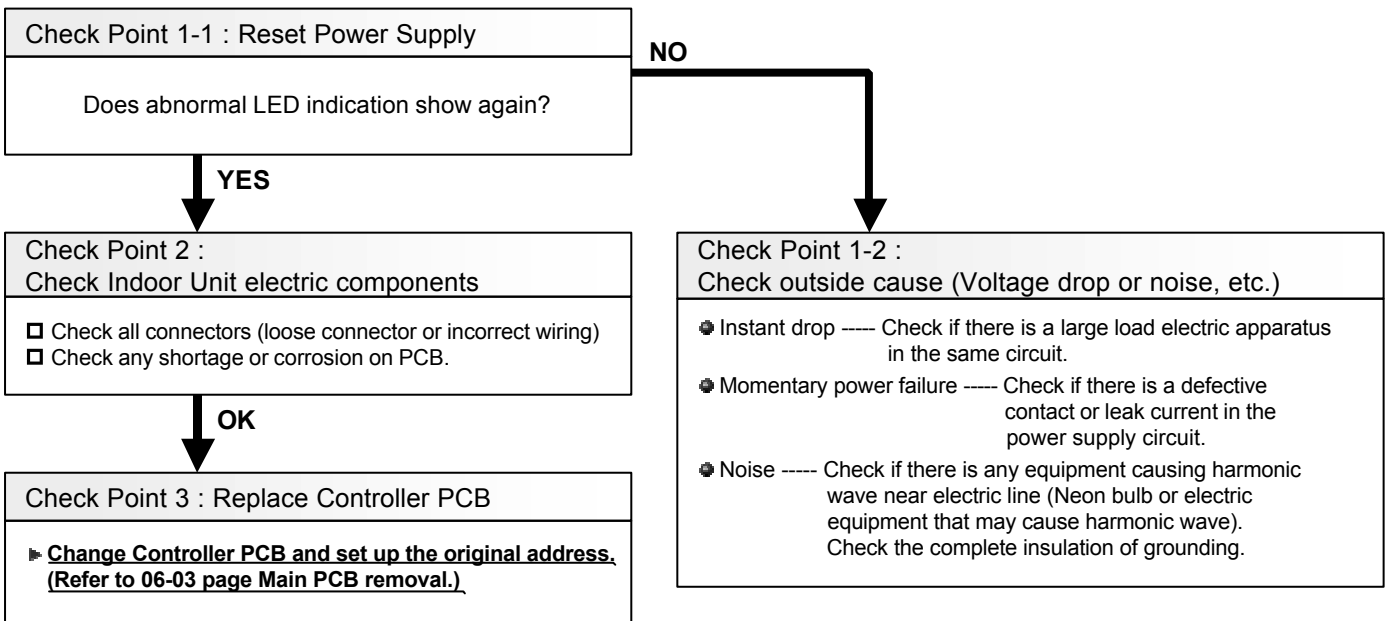

Note : EEPROM

EEPROM(Electronically Erasable and Programmable Read Only Memory) is a non-volatile memory which keeps memorized information even if power is turned off. It can change the contents electronically. To change the contents, it uses higher voltage than normal, and it can not change a partial contents. (Rewriting shall be done upon erasing the all contents.) There is a limit in a number of rewriting.

Trouble shooting 2 INDOOR UNIT Error Method: Power Frequency Abnormal	Indicate or Display: Outdoor Unit : E.5 U.1 Indoor Unit : Operation LED 3 times Flash, Timer LED 1 Times Flash, Filter LED Continuous Flash. Error Code : 3 1
--	--

Detective Actuators: Indoor Unit Controller PCB Circuit	Detective details: When 5 continuous failures occurred at Power frequency test.
---	---

Forecast of Cause : 1. Outside cause 2. Installation failure 3. Defective connection of electric components
4. Controller PCB defective

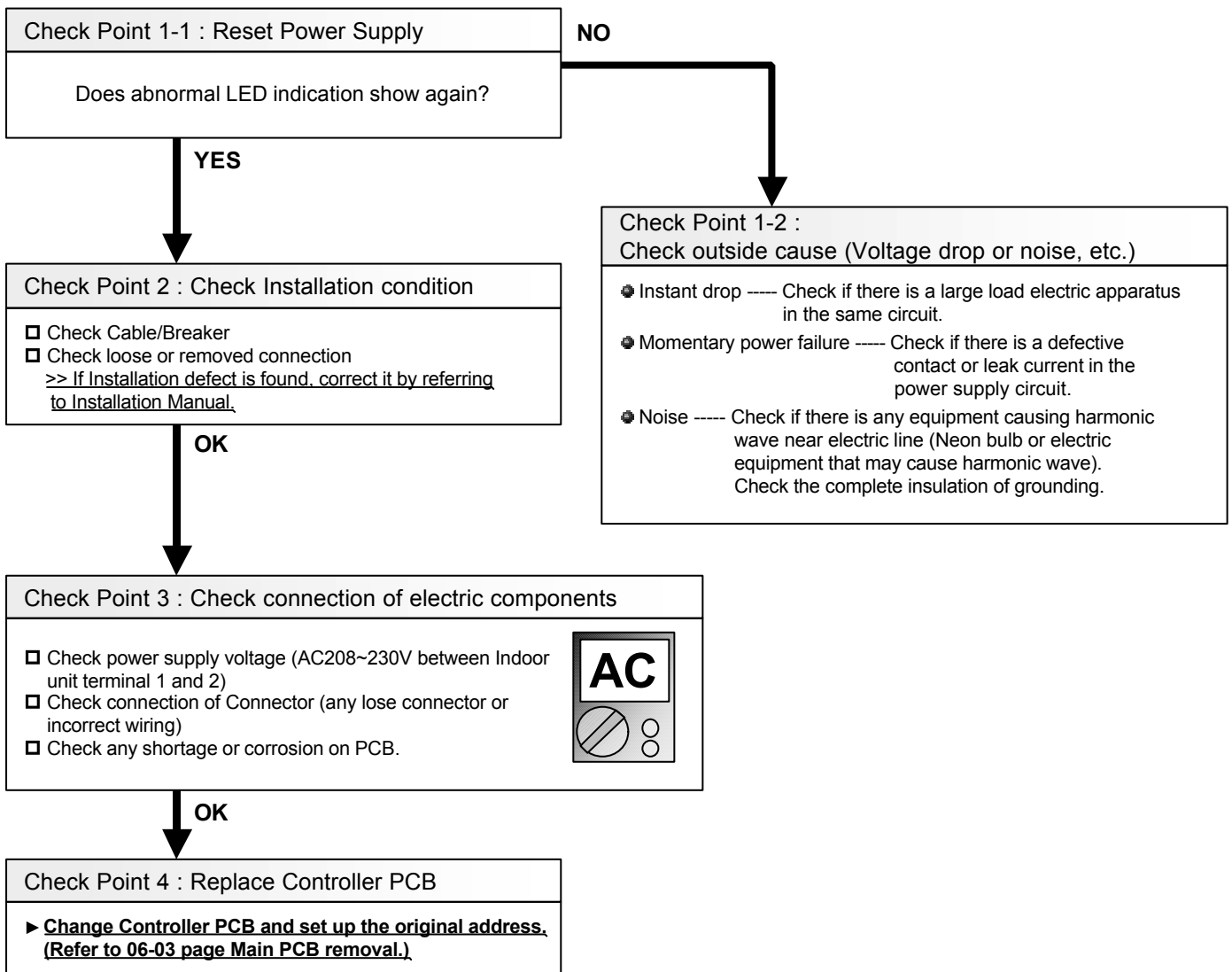

Trouble shooting 3 INDOOR UNIT Error Method: EEPROM Access Abnormal (Indoor Unit Main PCB Error)	Indicate or Display: Outdoor Unit : E.5 U.1 Indoor Unit : Operation LED 3 times Flash, Timer LED 2 Times Flash, Filter LED Continuous Flash. Error Code : 3 2
---	--

Detective Actuators: Indoor Unit Controller PCB Circuit	Detective details: When 3 continuous failure occurred on lead test of EEPROM.
---	---

Forecast of Cause : 1. Outside cause 2. Defective connection of electric component 3. Controller PCB defective

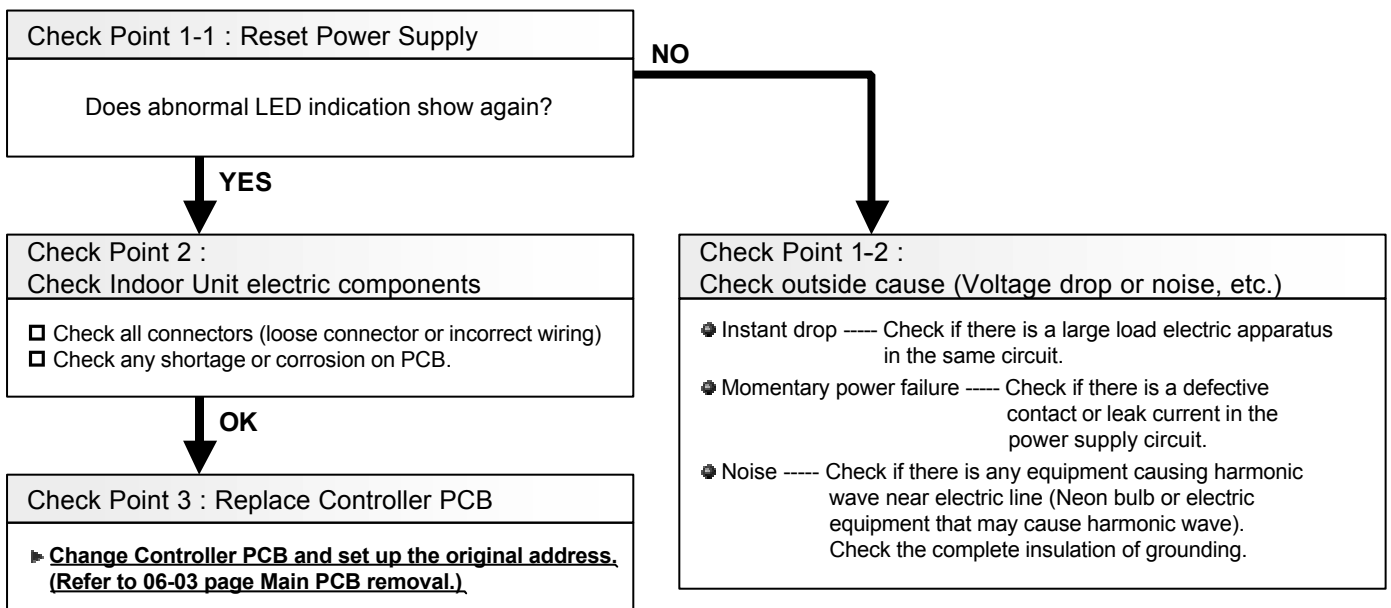

Trouble shooting 4 INDOOR UNIT Error Method: Room Temperature Sensor Error	Indicate or Display: Outdoor Unit : E.5 U.1 Indoor Unit : Operation LED 4 times Flash, Timer LED 1 Times Flash, Filter LED Continuous Flash. Error Code : 4 1

Detective Actuators: Indoor Unit Controller PCB Circuit Indoor Temperature Thermistor	Detective details: When Indoor thermistor open or shortage is detected at power ON.
--	---

Forecast of Cause : 1. Connector defective connection 2. Thermistor defective 3. Controller PCB defective

Check Point 1 : Check connection of Connector

- Check if connector is loose or removed
- Check erroneous connection
- Check if thermistor cable is open

>>Reset Power when reinstalling due to removed connector or incorrect wiring.



Check Point 2 : Remove connector and check Thermistor resistance value

Thermistor Characteristics (Rough value)

Temperature (°F)	32	41	50	59	68	77	86	95
Temperature (°C)	0	5	10	15	20	25	30	35
Resistance Value (kΩ)	33.6	25.2	20.1	15.8	12.5	10.0	8.0	6.5

Temperature (°F)	104	113	122
Temperature (°C)	40	45	50
Resistance Value (kΩ)	5.3	4.3	3.5

► If Thermistor is either open or shorted, replace it and reset the power.



Check Point 3 : Check voltage of Controller PCB (DC5.0V)

Make sure circuit diagram of each indoor unit and check terminal voltage at Thermistor (DC5.0V)

• Duct / High Static pressure Duct Model

H/E Inlet Thermistor (CN20 Wire:Black)

H/E Outlet Thermistor (CN20 Wire:Gray)

Room Temp. Thermistor (CN19 Wire:Black)

• Compact Wall mounted Model (Direct soldering to PCB)

H/E Inlet Thermistor (CN12 Wire:Black)

H/E Outlet Thermistor (CN11 Wire:Gray)

Room Temp. Thermistor (CN10 Wire:Black)

• Slim Duct / Cassette / Floor - Ceiling / Ceiling / Wall mounted Model

H/E Inlet Thermistor (CN9 Wire:Black)

H/E Outlet Thermistor (CN9 Wire:Gray)

Room Temp. Thermistor (CN8 Wire:Black)

► If the voltage does not appear, replace Controller PCB and set up the original address. (Refer to 06-03 page Main PCB removal.)

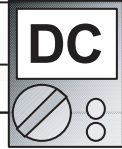

Trouble shooting 5 INDOOR UNIT Error Method: Heat Exchanger Inlet Sensor Error	Indicate or Display: Outdoor Unit : E.5 U.1 Indoor Unit : Operation LED 4 times Flash, Timer LED 2 Times Flash, Filter LED Continuous Flash. Error Code : 4 2
---	--

Detective Actuators: Indoor Unit Controller PCB Circuit Heat Exchanger Inlet Thermistor	Detective details: When open or shorted Heat Exchanger Inlet Thermistor is detected at Power ON.
--	--

Forecast of Cause : 1. Connector defective connection 2. Thermistor defective 3. Controller PCB defective

Check Point 1 : Check connection of Connector <input type="checkbox"/> Check if connector is loose or removed <input type="checkbox"/> Check erroneous connection <input type="checkbox"/> Check if thermistor cable is open >>Reset Power when reinstalling due to removed connector or incorrect wiring.
--



Check Point 2 : Remove connector and check Thermistor resistance value									
Thermistor Characteristics (Rough value)									
Temperature (°F)	32	41	50	59	68	77	86	95	
Temperature (°C)	0	5	10	15	20	25	30	35	
Resistance Value (kΩ)	168.6	129.8	100.9	79.1	62.5	49.8	40.0	32.4	
Temperature (°F)	104	113	122						
Temperature (°C)	40	45	50						
Resistance Value (kΩ)	26.3	21.2	17.8						
► If Thermistor is either open or shorted, replace it and reset the power.									



Check Point 3 : Check voltage of Controller PCB (DC5.0V)		
Make sure circuit diagram of each indoor unit and check terminal voltage at Thermistor (DC5.0V)		
· Duct / High Static pressure Duct Model 	· Compact Wall mounted Model (Direct soldering to PCB) 	
· Slim Duct / Cassette / Floor - Ceiling / Ceiling / Wall mounted Model H/E Inlet Thermistor (CN9 Wire:Black) H/E Outlet Thermistor (CN9 Wire:Gray) Room Temp. Thermistor (CN8 Wire:Black)		
► If the voltage does not appear, replace Controller PCB and set up the original address. (Refer to 06-03 page Main PCB removal.)		

Trouble shooting 6 INDOOR UNIT Error Method: Heat Exchanger Outlet Sensor Error	Indicate or Display: Outdoor Unit : E.5 U.1 Indoor Unit : Operation LED 4 times Flash, Timer LED 2 Times Flash, Filter LED Continuous Flash. Error Code : 4 2

Detective Actuators: Indoor Unit Controller PCB Circuit Heat Exchanger Outlet Thermistor	Detective details: When open or shorted Heat Exchanger outlet Thermistor is detected at Power ON.
---	---

Forecast of Cause : 1. Connector defective connection 2. Thermistor defective 3. Controller PCB defective

Check Point 1 : Check connection of Connector

- Check if connector is loose or removed
- Check erroneous connection
- Check if thermistor cable is open

>>Reset Power when reinstalling due to removed connector or incorrect wiring.



Check Point 2 : Remove connector and check Thermistor resistance value

Thermistor Characteristics (Rough value)

Temperature (°F)	32	41	50	59	68	77	86	95
Temperature (°C)	0	5	10	15	20	25	30	35
Resistance Value (kΩ)	168.6	129.8	100.9	79.1	62.5	49.8	40.0	32.4

Temperature (°F)	104	113	122
Temperature (°C)	40	45	50
Resistance Value (kΩ)	26.3	21.2	17.8

▶ **If Thermistor is either open or shorted, replace it and reset the power.**



Check Point 3 : Check voltage of Controller PCB (DC5.0V)

Make sure circuit diagram of each indoor unit and check terminal voltage at Thermistor (DC5.0V)

• Duct / High Static pressure Duct Model

H/E Inlet Thermistor (CN20 Wire:Black)
H/E Outlet Thermistor (CN20 Wire:Gray)
Room Temp. Thermistor (CN19 Wire:Black)

• Compact Wall mounted (Direct soldering to PCB)

H/E Inlet Thermistor (CN12 Wire:Black)
H/E Outlet Thermistor (CN11 Wire:Gray)
Room Temp. Thermistor (CN10 Wire:Black)

• Slim Duct / Cassette / Floor - Ceiling / Ceiling / Wall mounted Model

H/E Inlet Thermistor (CN9 Wire:Black)
H/E Outlet Thermistor (CN9 Wire:Gray)
Room Temp. Thermistor (CN8 Wire:Black)

Indoor unit Heat Exchanger

▶ **If the voltage does not appear, replace Controller PCB and set up the original address. (Refer to 06-03 page Main PCB removal.)**

Trouble shooting 7 INDOOR UNIT Error Method: Water Drain Abnormal	Indicate or Display: Outdoor Unit : E.5 U.1 Indoor Unit : Operation LED 5 times Flash, Timer LED 3 Times Flash, Filter LED Continuous Flash. Error Code : 5 3
--	--

Detective Actuators: Indoor Unit Controller PCB Circuit Float Switch	Detective details: When Float switch is ON for more than 3 minutes.
---	---

Forecast of Cause : 1. Float switch defective 2. Shorted connector/wire 3. Controller PCB defective 4. Drain pump defective

Check Point 1 : Check Float Switch	
<ul style="list-style-type: none"> <input type="checkbox"/> Check operation of float switch. (any blocking by dust, etc.) <input type="checkbox"/> Remove Float switch and check ON/OFF switching operation by using a meter. >>If Float switch is defective, replace it. 	

↓
OK

Check Point 2 : Check Connector (CN *) / Wire * CN1: Cassette / Slim-Duct / Floor-Ceiling / Ceiling / Wall mounted CN15: Duct / High Static pressure Duct
<ul style="list-style-type: none"> <input type="checkbox"/> Check loose contact of CN* / shorted wire (pinched wire). >>Replace Float switch if the wire is abnormal

↓
OK

Check Point 3 : Check Controller PCB
<ul style="list-style-type: none"> ▶ If Check Point 1 & 2 do not improve the symptom, change Controller PCB and set up the original address. (Refer to 06-03 page Main PCB removal.)

Trouble shooting 8 INDOOR UNIT Error Method: Indoor Unit Fan Motor Error	Indicate or Display: Outdoor Unit : E.5 U.1 Indoor Unit : Operation LED 5 times Flash, Timer LED 1 Times Flash, Filter LED Continuous Flash. Error Code : 5 1
---	--

Detective Actuators: Indoor Unit Controller PCB Circuit Indoor Fan Motor	Detective details: When Indoor fan control is either phase control or DC control and rotation feed back control is ON, the feed back rotation value becomes 0 and lasts for more than 1 minute at motor operation condition. Or, the feed back rotation value continues at 1/3 of target value for more than 1 minute.
---	--

Forecast of Cause : 1. Fan rotation failure 2. Fan motor winding open 3. Motor protection by surrounding temp. increase
 4. Capacitor failure 5. Control PCB failure

Check Point 1 : Check rotation of Fan

Rotate the fan by hand when operation is off.
 (Check if fan is caught, dropped off or locked motor)
>>If Fan or Bearing is abnormal, replace it.



Check Point 2 : Check Motor winding

Check Indoor Fan motor (PARTS INFORMATION 17, 19)
>>If Fan motor is abnormal, replace it.



Check Point 3 : Check ambient temp. around motor

Check excessively high temperature around the motor.
 (If there is any surrounding equipment that causes heat)
>>Upon the temperature coming down, restart operation.



Check Point 4 : Check Motor Capacitor

Check continuity of motor capacitor
>>If it is shorted, replace the capacitor.

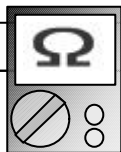

Check Point 5 : Replace Controller PCB

Change Controller PCB and set up the original address.

Attention!!
 In case of Duct type, replace Controller PCB and set up the original address, since it is a tapping control.

Trouble shooting 9 INDOOR UNIT Error Method: Wired Remote Controller Communication Error	Indicate or Display: Outdoor Unit : E.5 U.1 Indoor Unit : Operation LED 1 times Flash, Timer LED 2 Times Flash, Filter LED Continuous Flash. Error Code : 1 2
---	--

Detective Actuators: Indoor unit controller PCB circuit Wired Remote Control	Detective details: Upon receiving the signal more than 1 time from Wired Remote or other Indoor unit, but the same signal has not been received more than 1 minute.
---	---

Forecast of Cause : 1. Terminal connection abnormal 2. Wired Remote Control failure 3. Controller PCB failure

Check Point 1 : Check the connection of terminal

After turning off the power, check & correct the followings.

Indoor Unit - Check the connection of terminal between remote control and Indoor unit, or between Indoor units, and check if there is a disconnection or short of the cable.



Check Point 2 : Check Remote and Controller PCB	
<input type="checkbox"/> Check terminal voltage of controller PCB Connector (CN* : Power supply for Remote)	
* CN5: Slim Duct / Cassette / Floor - Ceiling / Ceiling , CN7: Compact wall, CN17: Wall / Duct / High static pressure Duct If DC12V line (Red - White) on the controller PCB is OK, Remote Control failure (Controller PCB is OK), Replace remote controller If DC12V line was other voltage, check the shorted the wire connection, or replace the controller PCB	
▶ In case of re-installation is done due to removed connector or incorrect wiring, turn on the power again.	

Trouble shooting 10 INDOOR UNIT Error Method: Wired Remote Controller Token Error	Indicate or Display: Outdoor Unit : E.5 U.1 Indoor Unit : Operation LED 1 times Flash, Timer LED 2 Times Flash, Filter LED Continuous Flash. Error Code : 1 2
--	--

Detective Actuators: Indoor unit Controller PCB circuit Wired Remote Control	Detective details: More than 1 time of Token (Communication between wired remote controllers) is received, but it was not received more than 1 minute.
---	--

Forecast of Cause : 1. Terminal connection abnormal 2. Mis-setting 3. Wired Remote Control failure 4. Controller PCB failure

Check Point 1 : Check the connection of terminal

After turning off the power, check & correct the followings.

Indoor Unit - Check the connection of terminal between remote control and Indoor unit, or between Indoor units, and check if there is a disconnection or short of the cable.

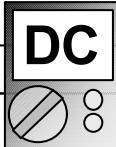

Check Point 2 : Check Remote and Controller PCB	
<input type="checkbox"/> Check terminal voltage of controller PCB Connector (CN* : Power supply for Remote)	
* CN5: Slim Duct / Cassette / Floor - Ceiling / Ceiling , CN7: Compact wall, CN17: Wall / Duct / High static pressure Duct If DC12V line (Red - White) on the controller PCB is OK, Remote Control failure (Controller PCB is OK), Replace remote controller If DC12V line was other voltage, check the shorted the wire connection, or replace the controller PCB	
▶ In case of re-installation is done due to removed connector or incorrect wiring, turn on the power again.	

Trouble shooting 11 INDOOR UNIT Error Method: Indoor Unit Parallel Communication Error	Indicate or Display: Outdoor Unit : E.5 U.1 Indoor Unit : Operation LED 1 times Flash, Timer LED 6 Times Flash, Filter LED Continuous Flash. Error Code : 1 6
--	---

Detective Actuators: Indoor unit Controller PCB circuit Indoor unit Communication PCB	Detective details: When Parallel communication error (Communication reset occurs continuously more than specified times) is detected.
--	---

Forecast of Cause : 1. Connection failure 2. Outside cause 3. Communication PCB failure 4. Controller PCB failure

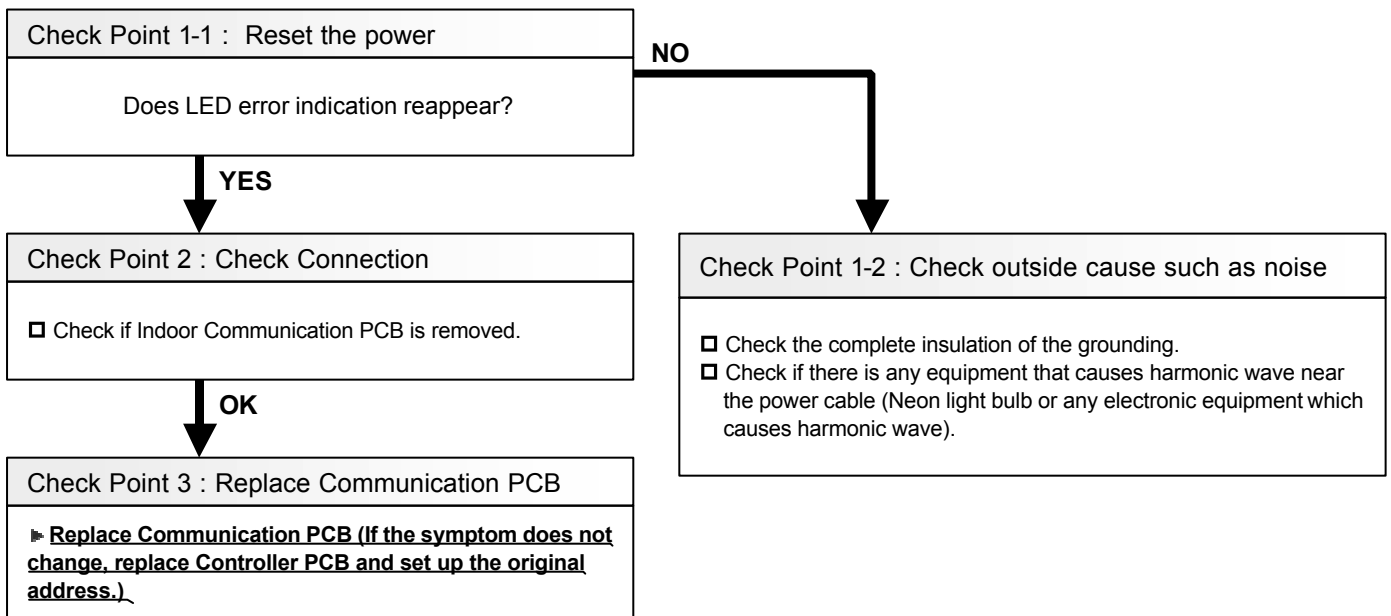

Trouble shooting 12 INDOOR UNIT Error Method: Network Communication Error	Indicate or Display: Outdoor Unit : E.5 U.1 Indoor Unit : Operation LED 1 times Flash, Timer LED 4 Times Flash, Filter LED Continuous Flash. Error Code : 1 4
--	--

Detective Actuators: Indoor unit Controller PCB circuit Indoor unit Communication PCB	Detective details: When the cut-off of network communication is detected (more than 90 seconds passed since the last receipt of Outdoor unit signal).
--	---

Forecast of Cause : 1. Connection failure 2. Total transmission line length exceeds 1640ft.(500m)
 3. Total number of units exceeds 65 units 4. Wrong terminal resistor setting
 5. Wrong I.U, O.U. address setting. 6. Outside cause 7. Communication PCB failure
 8. Controller PCB failure

Check Point 1 : Check the connection
<u>After turning off the power, check and correct followings.</u> <input type="checkbox"/> Is Indoor Communication PCB loose? <input type="checkbox"/> Check loose or removed connection of communication line between Indoor and Outdoor unit. <input type="checkbox"/> When the signal amplifier is connected, is it failure of signal amplifier? (Refer to "TROUBLE SHOOTING FOR OPTIONAL PARTS")



Check Point 2: Check Transmission wiring rules / SW setting
<input type="checkbox"/> Check the total transmission line length (The total transmission wire in one network segment has to be less than 1640ft.(500m) <input type="checkbox"/> Check the total number of connecting units (Total number of units on one network segment has to be less than 64 units) <input type="checkbox"/> Check the terminal resistor setting (One terminal resistor has to be activated on one network segment) > Check DIP SW setting on the outdoor unit controller PCB or signal amplifier <input type="checkbox"/> Check the IU. or OU. address setting (Refer to the design and technical manual)



Check Point 3 : Check if any outside cause such as voltage drop or noise
<ul style="list-style-type: none"> ⦿ Instant voltage drop ----- Check if there is any electric equipment with a large load within the same circuit. ⦿ Momentary power failure ----- Check contact failure or leak current in power supply circuit >>Check Outdoor Unit as well. ⦿ Check if there is any equipment that causes harmonic wave near the power cable (Neon light bulb or any electronic equipment which causes harmonic wave). And check the complete insulation of grounding. >>If the same symptom does not reappear after resetting the power, possibility of noise is high.



Check Point 4 : Check Communication PCB and Controller PCB
<input type="checkbox"/> If some of Indoor units have errors, replace Communication PCB of the Indoor units that have the error. >> If the symptom does not change, replace Indoor unit Controller PCB. <input type="checkbox"/> If all the Indoor units have error, check if the Outdoor Unit Communication PCB has a loose connection (Refer to Trouble Shooting 14,15,16). >> If the symptom does not change, replace Outdoor unit Communication PCB (Replace Controller PCB if it does not change).

4-3-2 Trouble Shooting With Error Code (OUTDOOR UNIT)

Trouble shooting 13 OUTDOOR UNIT Error Method: Initial Setting Error	Indicate or Display: Outdoor Unit : - - - - Indoor Unit : No Display Error Code : No Display
---	---

Detective Actuators: Outdoor unit main PCB	Detective details: Master unit: When the power is turned on, the number of connected slave units set at the master unit and the number of slave units received by communication do not match. Slave unit: When the power is turned on, not even one master unit communication data can be received.
--	--

Forecast of Cause : 1. Power supply defective 2. Outdoor unit address/number of connected slave units setting mistake 3. The number setting mistake of outdoor unit 4. Connection of communication line between outdoor units defective 5. Main PCB defective
--

Check Point 1 : Check the power supply
<input type="checkbox"/> Main power ON/OFF state check <input type="checkbox"/> Power cable connection, open check



Check Point 2 : Check the outdoor unit address/number of connected slave units setting												
<input type="checkbox"/> Setting check of outdoor unit address of each outdoor unit												
<table border="1" style="width: 100%;"> <thead> <tr> <th>Outdoor unit address</th> <th>SET 3-1</th> <th>SET 3-2</th> </tr> </thead> <tbody> <tr> <td>Master</td> <td>OFF</td> <td>OFF</td> </tr> <tr> <td>Slave 1</td> <td>OFF</td> <td>ON</td> </tr> <tr> <td>Slave 2</td> <td>ON</td> <td>OFF</td> </tr> </tbody> </table>	Outdoor unit address	SET 3-1	SET 3-2	Master	OFF	OFF	Slave 1	OFF	ON	Slave 2	ON	OFF
Outdoor unit address	SET 3-1	SET 3-2										
Master	OFF	OFF										
Slave 1	OFF	ON										
Slave 2	ON	OFF										
<input type="checkbox"/> Check the number setting of slave unit												
<table border="1" style="width: 100%;"> <thead> <tr> <th>Connected the number (Slave units)</th> <th>SET 3-3</th> <th>SET 3-4</th> </tr> </thead> <tbody> <tr> <td>0 unit</td> <td>OFF</td> <td>OFF</td> </tr> <tr> <td>1 unit</td> <td>OFF</td> <td>ON</td> </tr> <tr> <td>2 units</td> <td>ON</td> <td>OFF</td> </tr> </tbody> </table>	Connected the number (Slave units)	SET 3-3	SET 3-4	0 unit	OFF	OFF	1 unit	OFF	ON	2 units	ON	OFF
Connected the number (Slave units)	SET 3-3	SET 3-4										
0 unit	OFF	OFF										
1 unit	OFF	ON										
2 units	ON	OFF										



Check Point 3 : Check the number setting of outdoor units												
<input type="checkbox"/> Check the number setting of outdoor units												
<table border="1" style="width: 100%;"> <thead> <tr> <th>Number of outdoor unit</th> <th>DIP-SW SET5-1</th> <th>DIP-SW SET5-2</th> </tr> </thead> <tbody> <tr> <td>1 unit</td> <td>OFF</td> <td>OFF</td> </tr> <tr> <td>2 units</td> <td>OFF</td> <td>ON</td> </tr> <tr> <td>3 units</td> <td>ON</td> <td>OFF</td> </tr> </tbody> </table>	Number of outdoor unit	DIP-SW SET5-1	DIP-SW SET5-2	1 unit	OFF	OFF	2 units	OFF	ON	3 units	ON	OFF
Number of outdoor unit	DIP-SW SET5-1	DIP-SW SET5-2										
1 unit	OFF	OFF										
2 units	OFF	ON										
3 units	ON	OFF										



Check Point 4 : Check the connection of communication line between outdoor units
Drop the power and perform the check. <input type="checkbox"/> Connection and open check of communication lines between outdoor units



Check Point 5 : Replace Main PCB
<input type="checkbox"/> Change Main PCB and set up the original address (Refer to 06-03 page Main PCB removal.)

Trouble shooting 14 OUTDOOR UNIT Error Method: Communication Error Between Outdoor Unit	Indicate or Display: Outdoor Unit : E. 13. 1 Indoor Unit : Operation LED 9 times Flash, Timer LED 15 times Flash, Filter LED Continuous Flash. Error Code : 13
--	---

Detective Actuators: Outdoor unit main PCB	Detective details: Master unit: State in which "number of connected slave units" by Dip-SW and the number of slave units which can be recognized by communication did not match continued for 10 seconds or more after the start of control. Slave unit: State in which communication from the master unit was not received continued for 10 seconds or more after the start of control.
--	---

Forecast of Cause : 1. Noise, momentary open, voltage drop 2. Power supply defective
 3. The number setting mistake of outdoor unit
 4. Connection of communication lines between outdoor units defective 5. Main PCB defective

Check Point 1 : Noise, momentary open, voltage drop

- Check if temporary voltage drop was not generated.
- Check if momentary open was not generated.
- Check if ground is connection correctly or there are no related cables near the power line.

↓ **OK**

Check Point 2 : Check the power supply

- Main power ON/OFF state check
- Power cable connection, open check

↓ **OK**

Check Point 3 : Check the number setting of outdoor units

- Check the number setting of outdoor units

Number of outdoor unit	DIP-SW SET5-1	DIP-SW SET5-2
1 unit	OFF	OFF
2 units	OFF	ON
3 units	ON	OFF

↓ **OK**

Check Point 4 : Check the connection of communication lines between outdoor units

Turn off the power and check.

- Connection and open check of communication lines between outdoor units.

↓ **OK**

Check Point 5 : Replace Main PCB

- Change Main PCB and set up the original address.
(Refer to 06-03 page Main PCB removal.)

Trouble shooting 15 OUTDOOR UNIT Error Method: Outdoor Unit Network Communication 1 Error	Indicate or Display: Outdoor Unit : E. 14. 1 Indoor Unit : No display Error Code : 14
--	--

Detective Actuators: Outdoor unit Main PCB	Detective details: • No communication for 180 seconds or more from an indoor unit which received communication once and no outdoor network communication error 2.
--	---

Forecast of Cause : 1. Noise, momentary open, voltage drop 2. Indoor unit power off 3. Communication line connection 4. Transmission wiring rules / SW setting 5. Communication PCB mounting defective, Communication PCB defective 6. Controller PCB defective
--

Check Point 1 : Noise, momentary open, voltage drop
<input type="checkbox"/> Check if temporary voltage drop was not generated. <input type="checkbox"/> Check if momentary open was not generated. <input type="checkbox"/> Check if ground is connection correctly or there are no related cables near the power line.

↓ **OK**

Check Point 2 : Check the indoor unit power supply
<input type="checkbox"/> Main power ON check <input type="checkbox"/> Power cable connection and open check

↓ **OK**

Check Point 3 : Check the communication line connection
<input type="checkbox"/> Communication line (Indoor unit: X1, X2 / Other circuit: Z1, Z2 / Multi Outdoor unit: H1,H2) connection, open check <input type="checkbox"/> Transmission wire condition Reference: 56 ohm + X ohm(the resistance of network cable) per one network segment.

↓ **OK**

Check Point 4: Check Transmission wiring rules / SW setting
<input type="checkbox"/> Check the total transmission line length (The total transmission wire in one network segment has to be less than 1640ft.(500m) <input type="checkbox"/> Check the total number of connecting units (Total number of units on one network segment has to be less than 64 units) <input type="checkbox"/> Check the terminal resistor setting (One terminal resistor has to be activated on one network segment) > Check DIP SW setting on the outdoor unit controller PCB or signal amplifier <input type="checkbox"/> Check the IU. or OU. address setting (Refer to the design and technical manual)

↓ **OK**

Check Point 5 : Check the communication PCB (outdoor unit/indoor unit)
<input type="checkbox"/> Communication PCB connection check <input type="checkbox"/> Communication PCB check

↓ **OK**

Check Point 6 : Replace Main PCB (outdoor unit / indoor unit)
<input type="checkbox"/> Change Main PCB and set up the original address. (Refer to 06-03 page Main PCB removal.)

Trouble shooting 16 OUTDOOR UNIT Error Method : Outdoor Unit Network Communication 2 Error	Indicate or Display: Outdoor Unit : E. 14. 2 Indoor Unit : Operation LED 9 times Flash, Timer LED 15 Times Flash, Filter LED Continuous Flash. Error Code : 14
---	---

Detective Actuators: Outdoor unit Main PCB	Detective details: -No communication for 180 seconds or more from all indoor units that once received communication
--	---

Forecast of Cause : 1. Noise, momentary open, voltage drop 2. Indoor unit power off 3. Communication line connection 4. Transmission wiring rules / SW setting 5. Communication PCB mounting defective, Communication PCB defective 6. Controller PCB defective
--

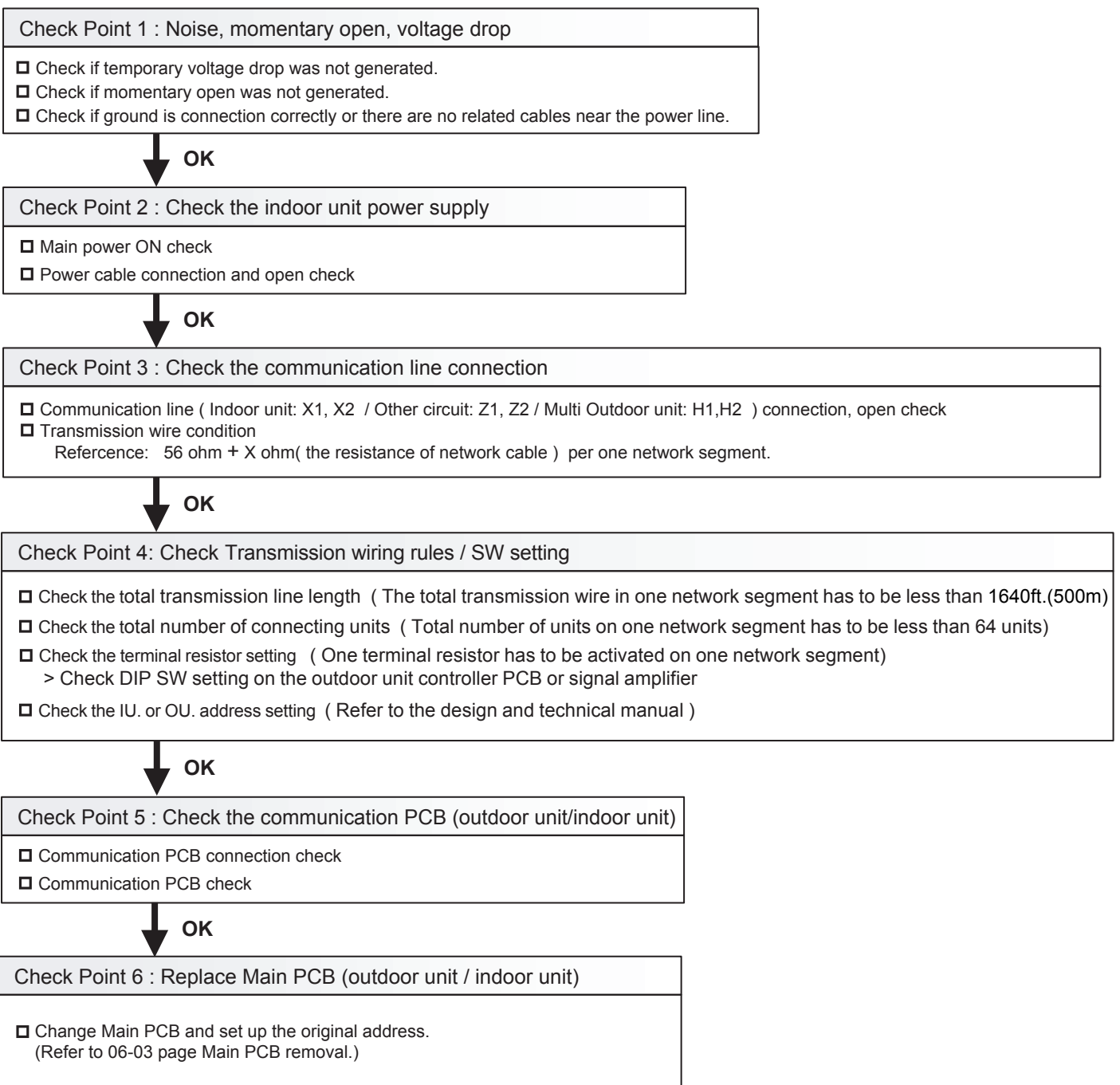

Trouble shooting 17 INDOOR UNIT Error Method: Indoor unit number shortage error	Indicate or Display:
	Outdoor Unit : E.1 4.5 Indoor Unit : No display Error Code : No display

Detective Actuators: Indoor unit Controller PCB circuit Indoor unit Communication PCB	Detective details: When the indoor unit number decreases for 180 seconds from the memorized maximum indoor units number after power(Breaker) ON.
--	--

Forecast of Cause : 1. Indoor unit power off 2. Noise, momentary open, voltage drop
 3. Communication line connection defective 4. Terminal resistor setting mistake
 5. Communication PCB mounting defective, Communication PCB defective 6. Controller PCB defective

Check Point 1 : Find the indoor unit that the communication is lost.

Check system drawing and service tool.



Check Point 2 : Check the indoor unit power supply

Main power ON check
 Power cable connection and open check



Check Point 2 : Noise, momentary open, voltage drop

Check if temporary voltage drop was not generated.
 Check if momentary open was not generated.
 Check if ground is connection correctly or there are no related cables near the power line.



Check Point 3 : Check the communication line connection

Communication line connection, open check



Check Point 4 : Check the Terminal resistor setting

Terminal resistor setting check



Check Point 5 : Check the communication PCB (indoor unit / outdoor unit)

Communication PCB connection check
 Communication PCB check



Check Point 6 : Replace Main PCB and Communication PCB (indoor unit / outdoor unit)

Change Main PCB and Communication PCB, and set up the original address.
 (Refer to 06-03 page Main PCB removal.)

Attention!!
 Even if this error occurs, system does not stop.
 If the failure indoor unit is pinpointed and it needs to erase the error indication, it can be reset by function setting (F3-41: Maximum memorized indoor unit number reset).

Trouble shooting 18 UTDOOR UNIT Error Method: Auto Address Setting Error	Indicate or Display: Outdoor Unit : E. 28. 1 Indoor Unit : No Display Error Code : 28
---	--

Detective Actuators: Outdoor unit Main PCB	Detective details: • When none of the connected indoor units answers during auto address And when abnormal answer signal is input.
--	---

Forecast of Cause : 1. Indoor unit power supply defective 2 Indoor unit overconnected 3.Communication line incorrect connection 4. Noise, momentary open
--

Check Point 1 : Check the indoor unit power supply <input type="checkbox"/> Check the indoor unit power supply
--



Check Point 2 : Check the indoor unit number connection <input type="checkbox"/> Check if more than 64 indoor units are connected in a refrigerant circuit
--



Check Point 3 : Check the communication line connection Check if communication line is correctly connected <input type="checkbox"/> Is it uncoupled or cut halfway ? <input type="checkbox"/> Connecting terminal position is correct as the installation manual shows ?
--



Check Point 4 : Check noise, momentary open, voltage drop <input type="checkbox"/> Check if power supply temporarily stops by outages or if strong noise is generated from surrounding environment during auto address
--

Trouble shooting 19 <u>UTDOOR UNIT Error Method:</u> Signal Amplifier Auto Address Error	<u>Indicate or Display:</u> Outdoor Unit : E. 28. 4 Indoor Unit : No Display Error Code : 28
---	---

<u>Detective Actuators:</u> Outdoor unit Main PCB	<u>Detective details:</u> ▪ When abnormal answer signal is input during signal amplifier auto address
---	---

<u>Forecast of Cause :</u> 1. Signal amplifier power supply defective 2. Signal amplifier overconnected 3. Signal amplifier auto address wrong setting 4. Noise, momentary open.
--

Check Point 1 : Check signal amplifier unit power supply <input type="checkbox"/> Check signal amplifier unit power supply
--

↓ **OK**

Check Point 2 : Check the signal amplifier number connection <input type="checkbox"/> Check if more than 8 signal amplifiers are connected in a network

↓ **OK**

Check Point 3 : Check the operation of signal amplifier auto address setting <input type="checkbox"/> Check if signal amplifier auto address is set at the same time from multiple outdoor units (master unit)
--

↓ **OK**

Check Point 4 : Check noise, momentary open, voltage drop <input type="checkbox"/> Check if power supply temporarily stops by outages or if strong noise is generated from surrounding environment during signal amplifier auto address

Trouble shooting 20 OUTDOOR UNIT Error Method: Outdoor Unit Reverse Phase, Missing Phase Wire Error	Indicate or Display: Outdoor Unit : E. 61. 5 Indoor Unit : Operation LED 9 times Flash, Timer LED 15 Times Flash, Filter LED Continuous Flash. Error Code : 61
--	---

Detective Actuators: Outdoor unit Main PCB	Detective details: •Reverse phase prevention circuit detected reversed phase input or input was not normal.
--	---

Forecast of Cause : 1. Noise, momentary open, voltage drop 2. Power supply defective
 3. Filter PCB (Main) defective 4. Main PCB defective

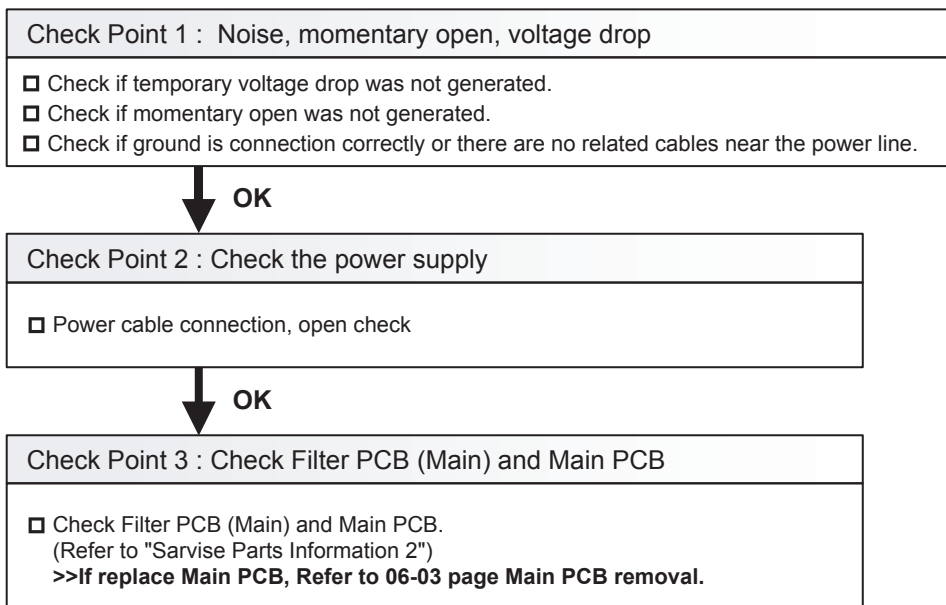

Trouble shooting 21 OUTDOOR UNIT Error Method: Outdoor Unit EEPROM Access Error	Indicate or Display: Outdoor Unit : E. 62. 3 Indoor Unit : Operation LED 9 times Flash, Timer LED 15 Times Flash, Filter LED Continuous Flash. Error Code : 62
--	---

Detective Actuators: Outdoor unit Main PCB	Detective details: •Access to EEPROM failed due to some cause after outdoor unit started.
--	---

Forecast of Cause : 1. Noise, momentary open, voltage drop 2. Main PCB defective

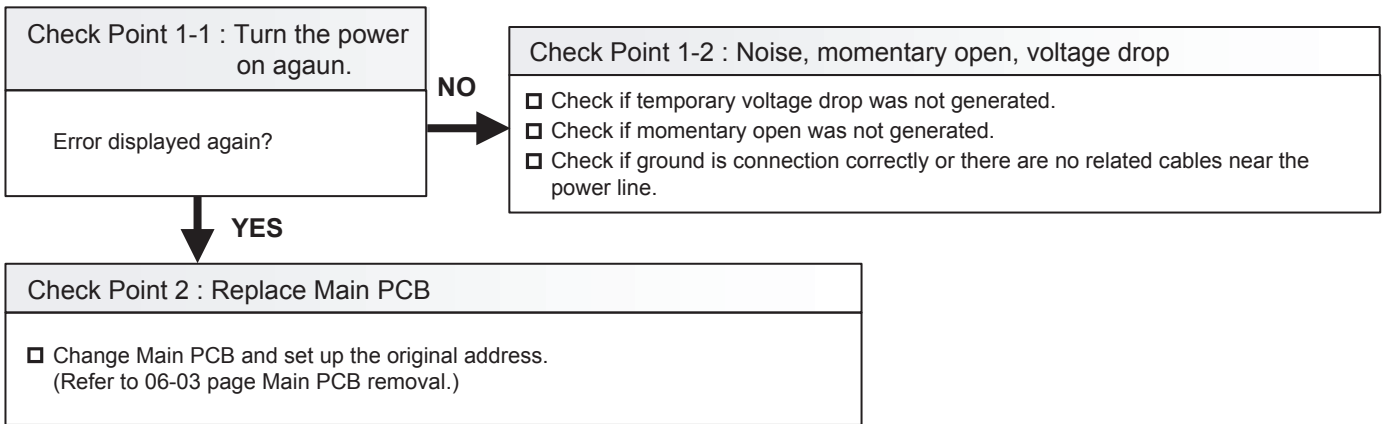

Trouble shooting 22 OUTDOOR UNIT Error Method: Inverter Communication Error	Indicate or Display: Outdoor Unit : E. 62. 6 Indoor Unit : Operation LED 9 times Flash, Timer LED 15 Times Flash, Filter LED Continuous Flash. Error Code : 62
--	---

Detective Actuators: Outdoor unit Main PCB	Detective details: •Communication not received from Inverter PCB for 10 seconds or more
--	---

Forecast of Cause : 1. Noise 2. Main to Inverter PCBs wiring connection defective
 3. Main PCB defective 4. Inverter PCB defective

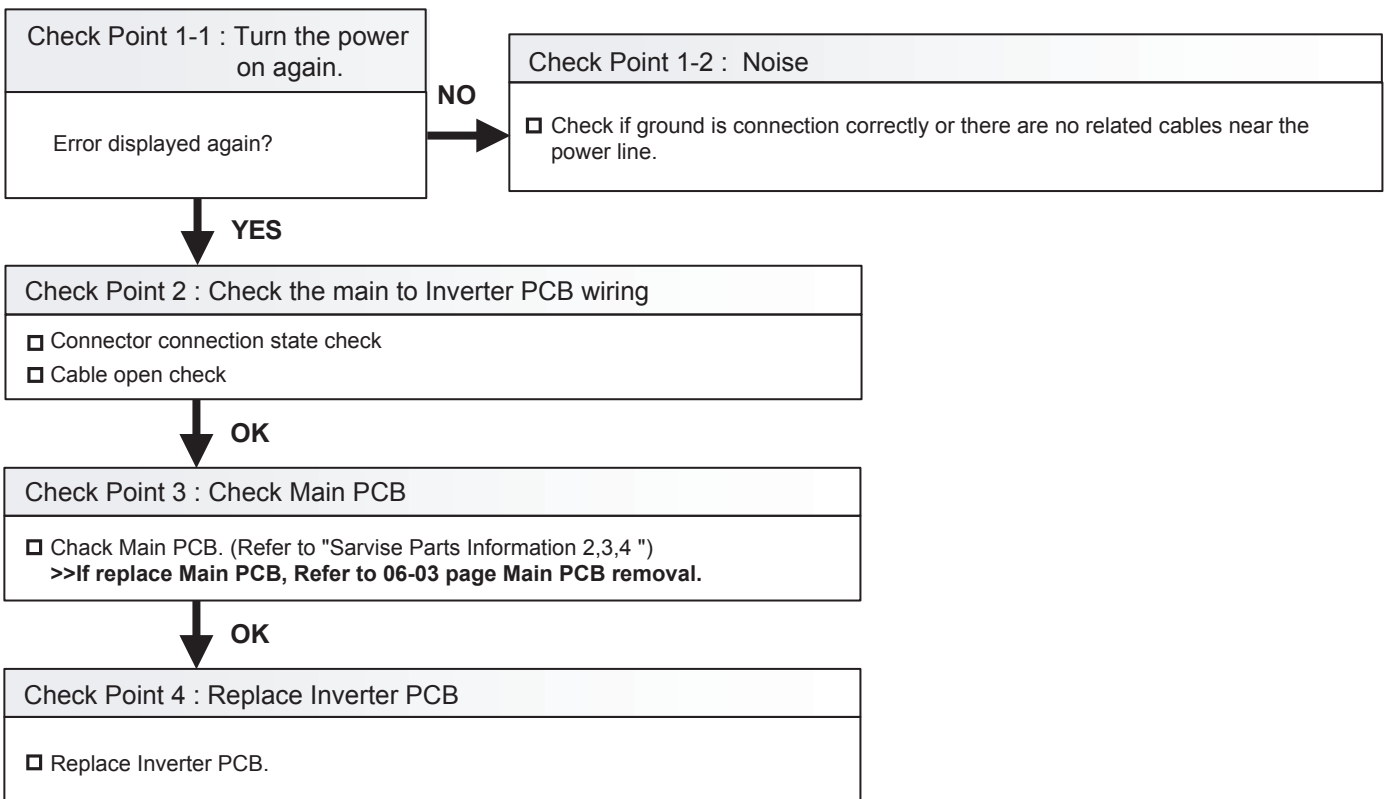

Trouble shooting 23 OUTDOOR UNIT Error Method: Outdoor Unit EEPROM Data Error	Indicate or Display: Outdoor Unit : E. 62. 8 Indoor Unit : Operation LED 9 times Flash, Timer LED 15 Times Flash, Filter LED Continuous Flash. Error Code : 62
--	---

Detective Actuators: Outdoor unit Main PCB	Detective details: <ul style="list-style-type: none"> ▪ Set contents sum value memorized in EEPROM and sum value calculated based on the set contents read from EEPROM do not match * Regarding the sum value, only the contents set in the push button SW setting mode (F2) shall be the objective.
--	--

Forecast of Cause : 1. Noise, momentary open, voltage drop 2. Main PCB defective

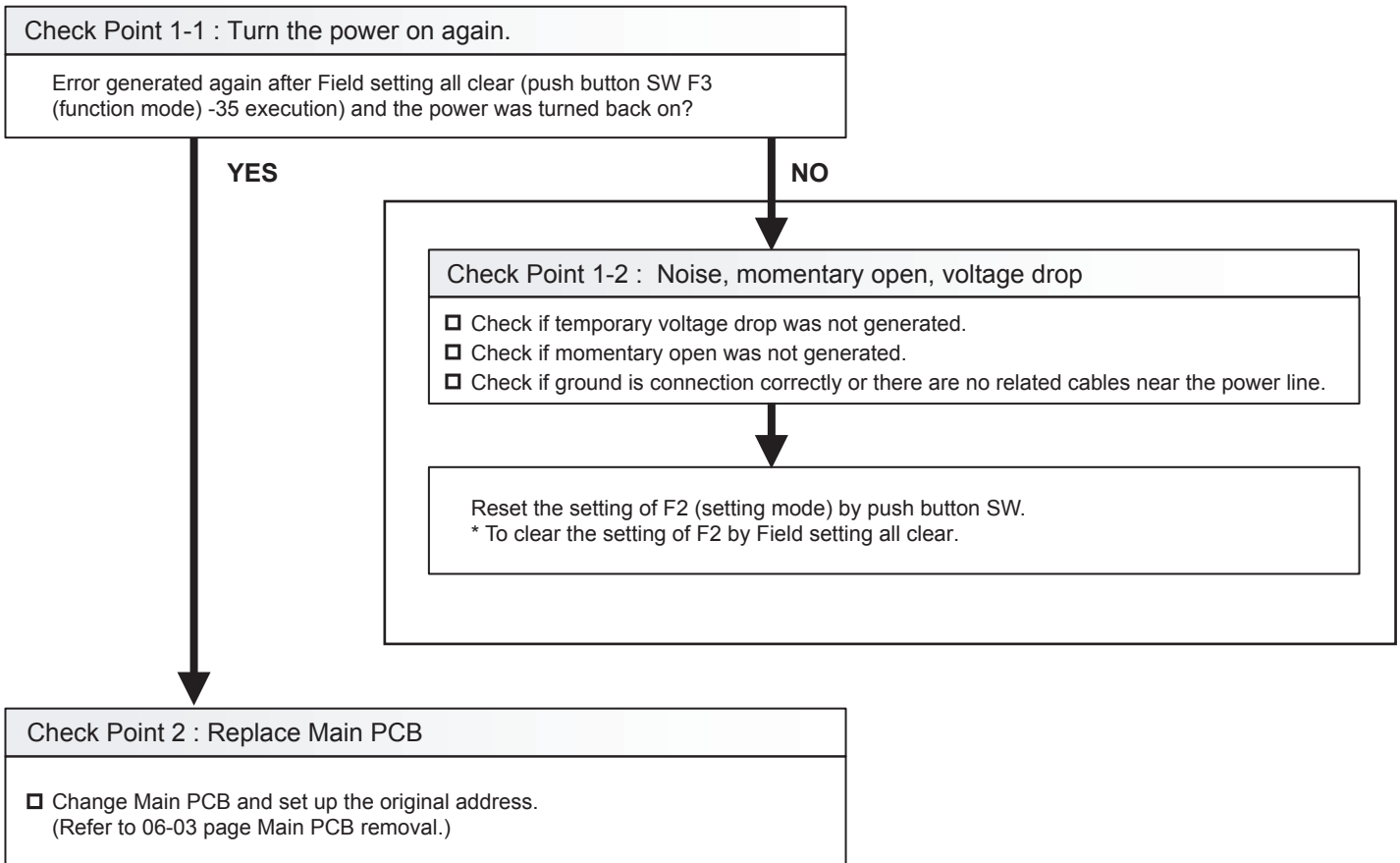

Trouble shooting 24 OUTDOOR UNIT Error Method: Inverter Error	Indicate or Display: Outdoor Unit : E. 63. 1 Indoor Unit : Operation LED 9 times Flash, Timer LED 15 Times Flash, Filter LED Continuous Flash. Error Code : 63
--	---

Detective Actuators: Inverter PCB	Detective details: •Error information received from Inverter PCB
---	--

Forecast of Cause : 1. Noise, momentary open, voltage drop. 2. Power supply to Filter PCB (INV) to Inverter PCB wiring disconnection, open 3. Filter PCB (INV) defective 4. Inverter PCB defective 5. Cement Resistor Open circuit

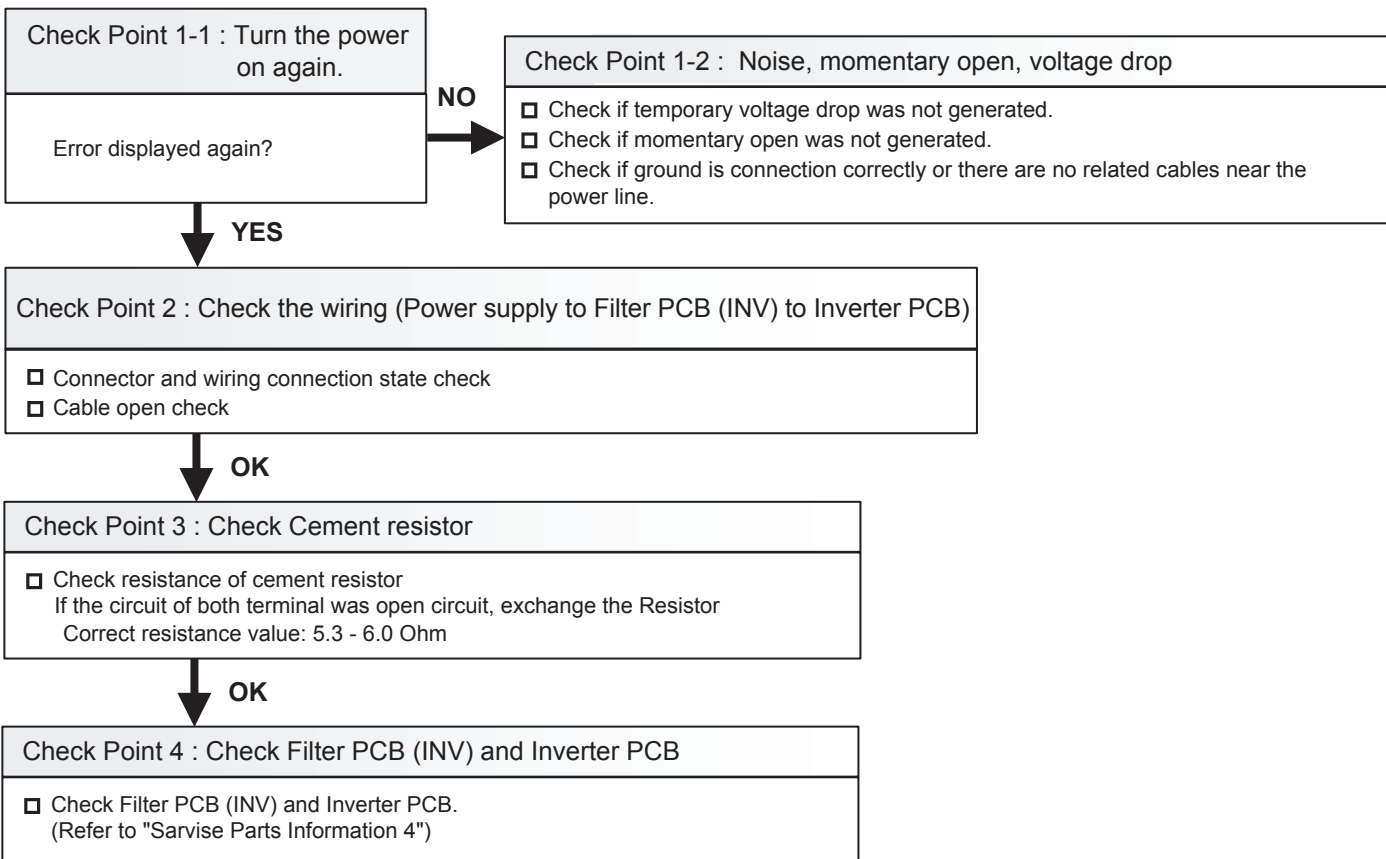

Trouble shooting 25 OUTDOOR UNIT Error Method: Inverter PCB Momentary Power Failure Detection	Indicate or Display: Outdoor Unit : E. 67. 2 Indoor Unit : No Display Error Code : 67
--	--

Detective Actuators: Inverter PCB	Detective details: · "Momentary power failure" received from Inverter PCB
---	---

Forecast of Cause : 1. Noise, momentary power failure, voltage drop 2. Magnetic Relay (for Inverter) coil side wiring disconnection, open 3. Power supply to Filter PCB (INV) to Inverter PCB wiring disconnection, open 4. Main PCB defective 5. Inverter PCB defective

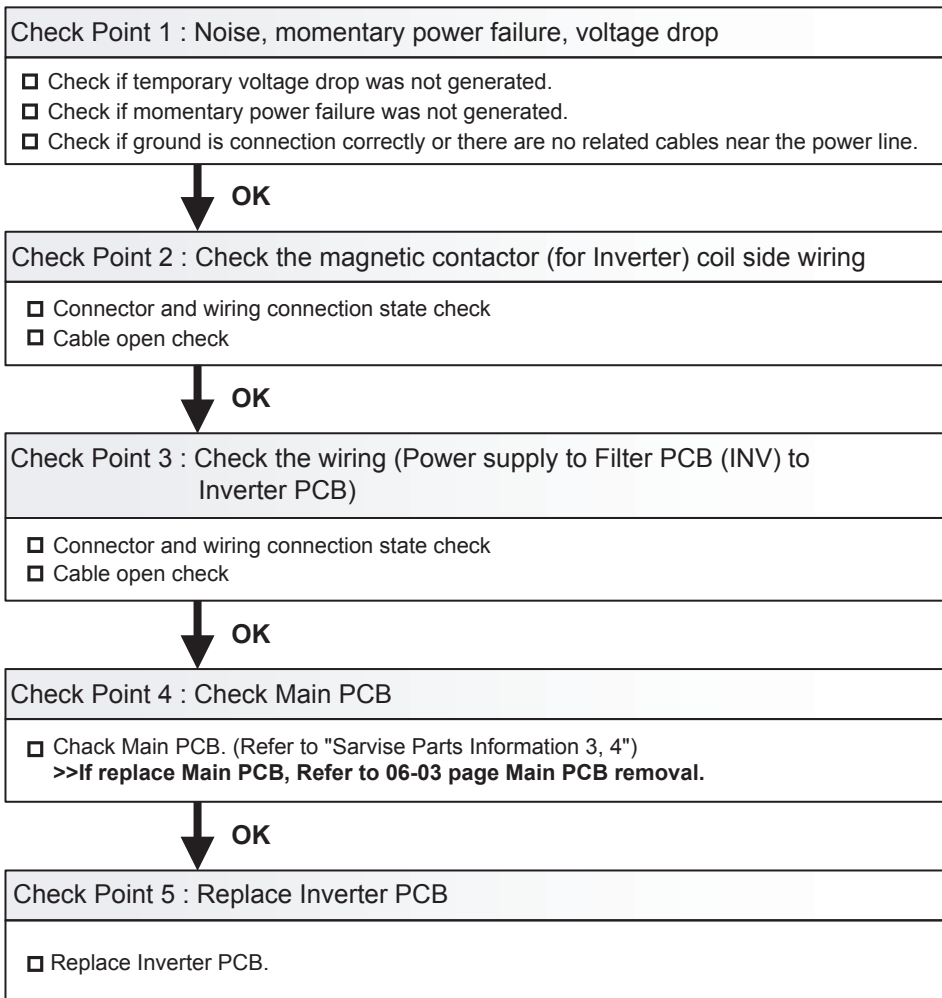

Trouble shooting 26 OUTDOOR UNIT Error Method: Rush Current Limiting Resistor Temp Rise Protection	Indicate or Display: Outdoor Unit : E. 68. 2 Indoor Unit : Operation LED 9 times Flash, Timer LED 15 Times Flash, Filter LED Continuous Flash. Error Code : 68
---	---

Detective Actuators: Inverter PCB	Detective details: ▪ "Protection stop by "Rush current limiting resistor temperature rise detection" of inverter PCB" was generated 2 times.
---	--

Forecast of Cause :	1. Magnetic relay (for INV) coil side wiring disconnection, open 2. Power supply to Filter PCB (INV) to Inverter PCB wiring disconnection, open 3. Magnetic relay activation circuit defective 6. Main PCB output 230 VAC on CN130 defective Main PCB defective (output 230VAC on CN130 for Magnetic relay (INV) defective)
----------------------------	---

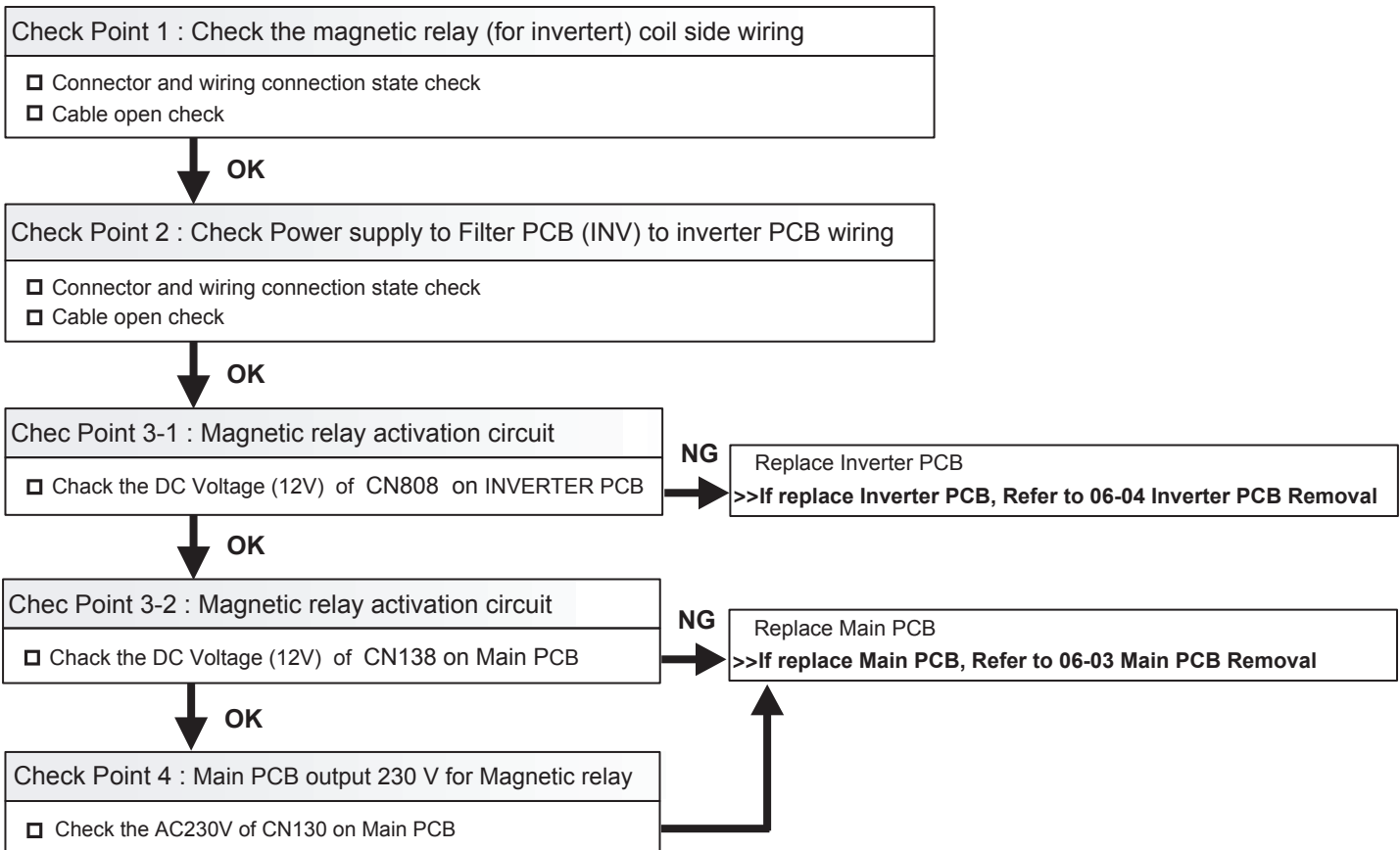

After fixing the problem and for canceling the Error, Error Reset (F3-40) will be required after power reset

Trouble shooting 27 OUTDOOR UNIT Error Method: Outdoor Unit Communication PCB Parallel Communication Error	Indicate or Display: Outdoor Unit : E. 69. 1 Indoor Unit : Operation LED 9 times Flash, Timer LED 15 Times Flash, Filter LED Continuous Flash. Error Code : 69
---	---

Detective Actuators: Outdoor unit Main PCB	Detective details: •Parallel communication (communication between master PC and Neuron Chip) failed 5 times.
--	--

Forecast of Cause :

1. Wrong terminal resistor set in the transmission segment
2. Noise
3. Communication PCB connection defective
4. Communication PCB defective
5. Main PCB defective

Check Point 1 : Check the terminal resistor setting

- No terminal resistor set in the single network segment
- Dual terminal resistor set in the single network segment
- DIP SW SET5-4 OFF: Disable (Factory setting)
ON : Enable

↓
OK

Check Point 2-1 : Turn the power on again.

Error displayed again?

→ **NO**

Check Point 2-2 : Noise

- Check if ground is connection correctly or there are no related cables near the power line.

↓
YES

Check Point 3 : Check the communication PCB connection

- Communication PCB connection check

↓
OK

Check Point 4 : Check the communication PCB

- Communication PCB check

↓
OK

Check Point 5 : Replace Main PCB

- Change Main PCB and set up the original address.
(Refer to 06-03 page Main PCB removal.)

Trouble shooting 28 OUTDOOR UNIT Error Method: Discharge Temp Sensor 1 Error	Indicate or Display: Outdoor Unit : E. 71. 1 Indoor Unit : Operation LED 9 times Flash, Timer LED 15 Times Flash, Filter LED Continuous Flash. Error Code : 71
---	---

Detective Actuators: Discharge temperature thermistor 1	Detective details: <ul style="list-style-type: none"> • Discharge temperature thermistor 1 short detected • Discharge thermistor 1 open detected after compressor 1 operated continuously for 5 minutes or more
---	---

Forecast of Cause : <ol style="list-style-type: none"> 1. Connector connection defective, open 2. Thermistor defective 3. Main PCB defective
--

Check Point 1 : Check the connector connection and cable open
<input type="checkbox"/> Connector connection state check <input type="checkbox"/> Cable open check



Check Point 2 : Check the thermistor
<input type="checkbox"/> Thermistor characteristics check (Disconnect the thermistor from the PCB and check.) * For the thermistor characteristics, refer to the "Service Parts Information 22".

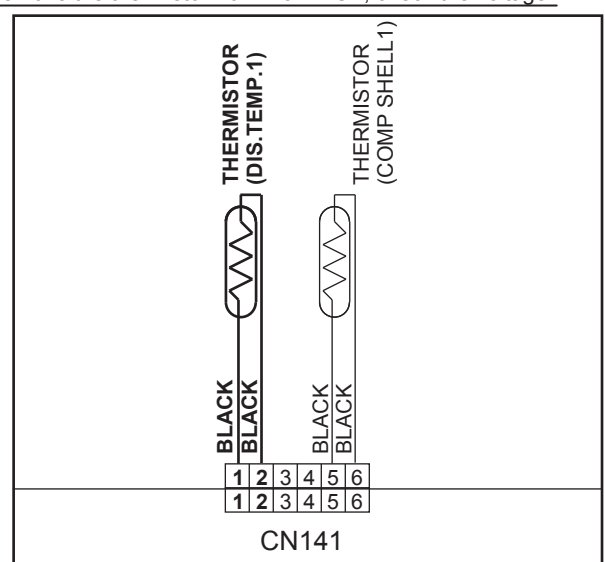
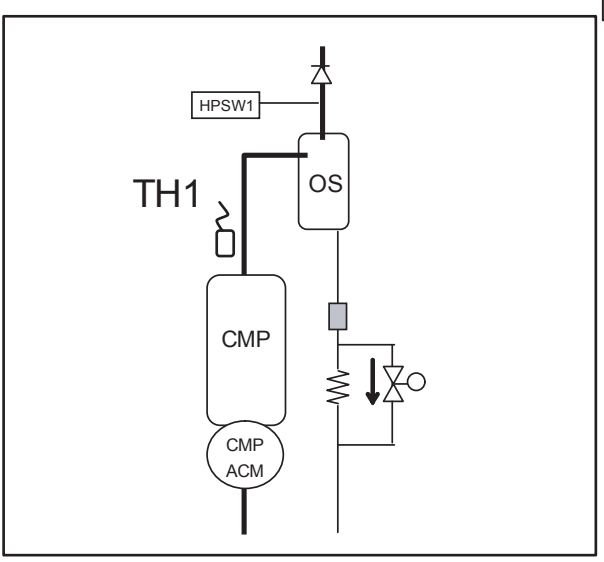

Check Point 3 : Check voltage of Main PCB (DC5.0V)	<div style="border: 1px solid black; padding: 2px; display: inline-block;">DC</div> 
<input type="checkbox"/> Main PCB (CN141:1-2) voltage value = 5V <u>Remove the thermistor from Main PCB, check the voltage.</u>	
	
Discharge temperature sensor 1 (CN141:1-2) ▶ If the voltage does not appear, replace Main PCB and set up original address. (Refer to 06-03 page Main PCB removal.)	

After fixing the problem and for canceling the Error, Error Reset (F3-40) will be required after power reset

Trouble shooting 29 OUTDOOR UNIT Error Method: Compressor Temp Sensor 1 Error	Indicate or Display: Outdoor Unit : E. 72. 1 Indoor Unit : Operation LED 9 times Flash, Timer LED 15 Times Flash, Filter LED Continuous Flash. Error Code : 72
--	---

Detective Actuators: Compressor temperature thermistor 1	Detective details: <ul style="list-style-type: none"> • Compressor temperature thermistor 1 short detected • Compressor thermistor 1 open detected after compressor 1 operated continuously for 5 minutes or more
--	---

Forecast of Cause : <ol style="list-style-type: none"> 1. Connector connection defective, open 2. Thermistor defective 3. Main PCB defective
--

Check Point 1 : Check the connector connection and cable open

- Connector connection state check
- Cable open check



Check Point 2 : Check the thermistor

- Thermistor characteristics check (Disconnect the thermistor from the PCB and check.)
 * For the thermistor characteristics, refer to the "Service Parts Information 22".



Check Point 3 : Check voltage of Main PCB (DC5.0V)

- Main PCB (CN141:5-6) voltage value = 5V
 Remove the thermistor from Main PCB, check the voltage.

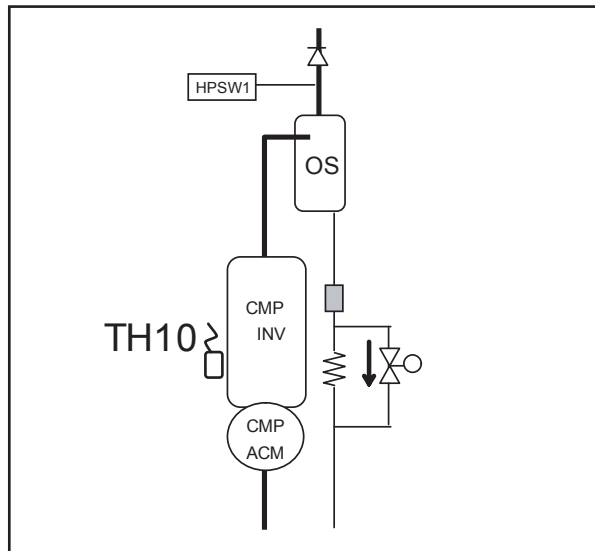
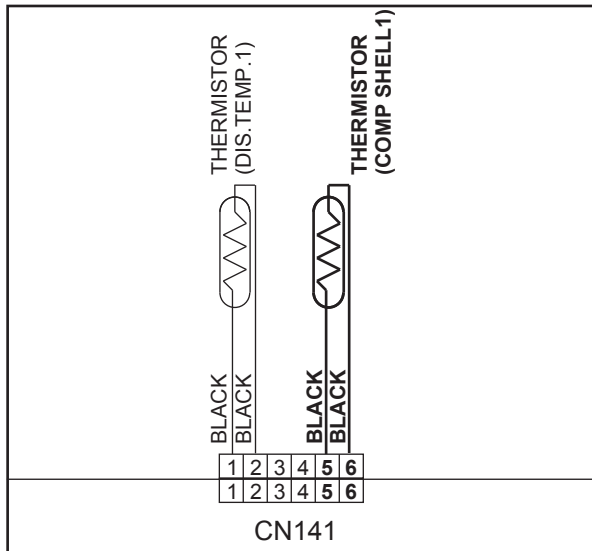

Compressor temperature sensor 1 (CN141:5-6)

► **If the voltage does not appear, replace Main PCB and set up original address.**
 (Refer to 06-03 page Main PCB removal.)

After fixing the problem and for canceling the Error, Error Reset (F3-40) will be required after power reset

Trouble shooting 30 OUTDOOR UNIT Error Method: Outdoor Unit Heat Ex. Liquid Temp. Sensor Error	Indicate or Display: Outdoor Unit : E. 73. 3 Indoor Unit : Operation LED 9 times Flash, Timer LED 15 Times Flash, Filter LED Continuous Flash. Error Code : 73
---	---

Detective Actuators: Heat exchanger liquid temperature thermistor	Detective details: • Heat exchanger liquid temperature thermistor short or open detected
---	--

Forecast of Cause :	1. Connector connection defective, open 2. Thermistor defective 3. Main PCB defective
----------------------------	---

Check Point 1 : Check the connector connection and cable open
<input type="checkbox"/> Connector connection state check <input type="checkbox"/> Cable open check



Check Point 2 : Check the thermistor
<input type="checkbox"/> Thermistor characteristics check (Disconnect the thermistor from the PCB and check.) * For the thermistor characteristics, refer to the "Service Parts Information 22".

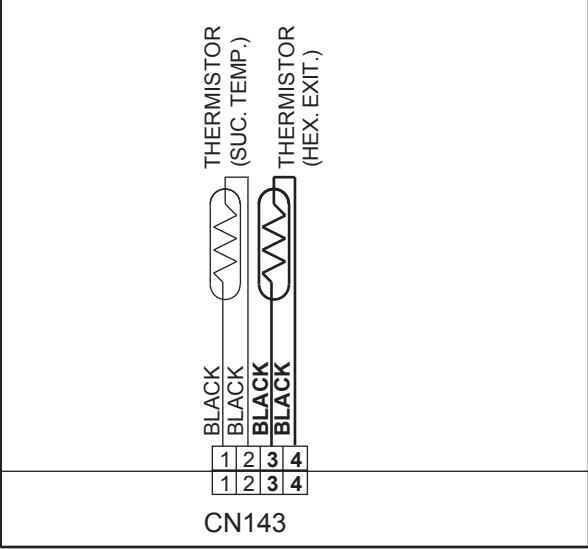
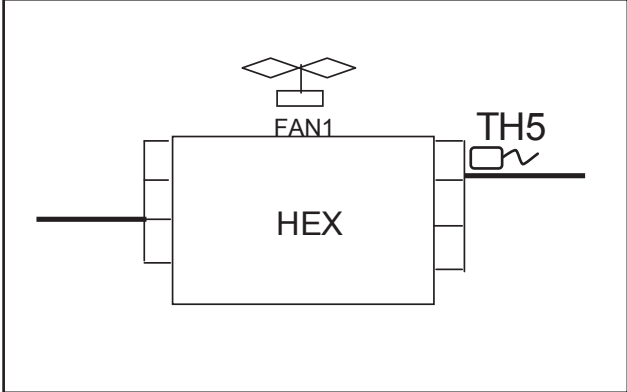

Check Point 3 : Check voltage of Main PCB (DC5.0V)	<div style="border: 1px solid black; padding: 5px; display: inline-block;"> DC  </div>
<input type="checkbox"/> Main PCB (CN143:3-4) voltage value = 5V <u>Remove the thermistor from Main PCB, check the voltage.</u>	
	
Heat exchanger liquid temperature sensor (CN143:3-4)	
▶ If the voltage does not appear, replace Main PCB and set up original address. (Refer to 06-03 page Main PCB removal.)	

Trouble shooting 31 OUTDOOR UNIT Error Method: Outdoor Temp Sensor Error	Indicate or Display: Outdoor Unit : E. 74. 1 Indoor Unit : Operation LED 9 times Flash, Timer LED 15 Times Flash, Filter LED Continuous Flash. Error Code : 74
---	---

Detective Actuators: Outdoor temperature thermistor	Detective details: • Outdoor temperature thermistor short or open detected
---	--

Forecast of Cause : <ol style="list-style-type: none"> 1. Connector connection defective, open 2. Thermistor defective 3. Main PCB defective
--

Check Point 1 : Check the connector connection and cable open
<input type="checkbox"/> Connector connection state check <input type="checkbox"/> Cable open check

↓ **OK**

Check Point 2: Check the thermistor
<input type="checkbox"/> Thermistor characteristics check (Disconnect the thermistor from the PCB and check.) * For the thermistor characteristics, refer to the "Service Parts Information 22".

↓ **OK**

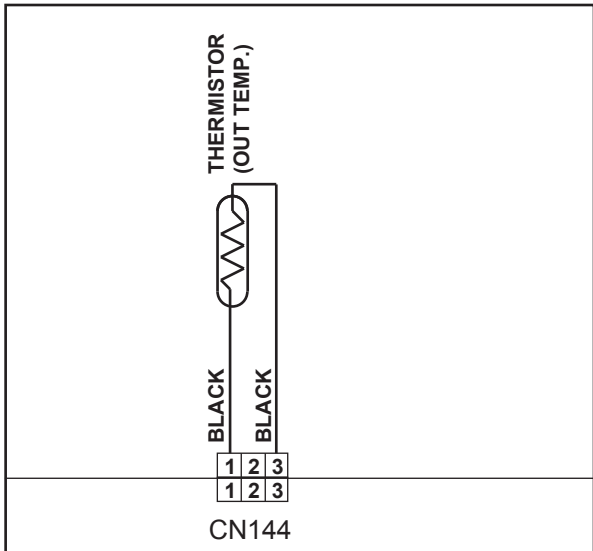
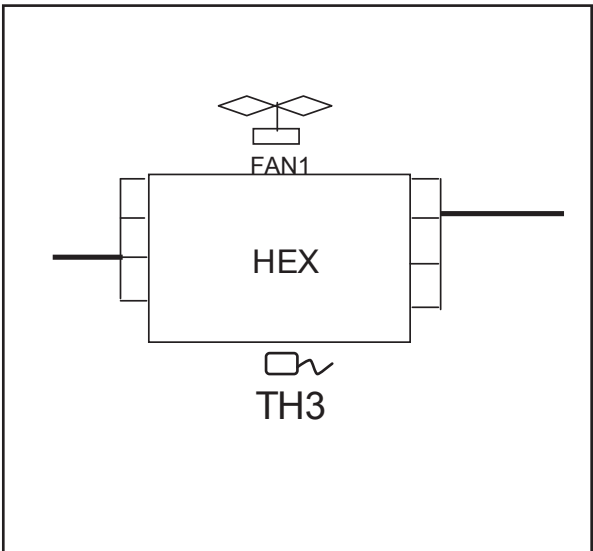
Check Point 3 : Check voltage of Main PCB (DC5.0V)	<div style="border: 1px solid black; padding: 2px; display: inline-block;">DC</div> 
<input type="checkbox"/> Main PCB (CN144:1-3) voltage value = 5V <u>Remove the thermistor from Main PCB, check the voltage.</u>	
 <p style="text-align: center;">Outdoor temperature sensor (CN144:1-3)</p>	
<p>▶ If the voltage does not appear, replace Main PCB and set up original address. (Refer to 06-03 page Main PCB removal.)</p>	

Trouble shooting 32 OUTDOOR UNIT Error Method: Suction Gas Temp Sensor Error	Indicate or Display: Outdoor Unit : E. 75. 1 Indoor Unit : Operation LED 9 times Flash, Timer LED 15 Times Flash, Filter LED Continuous Flash. Error Code : 75
---	---

Detective Actuators: Suction gas temperature thermistor	Detective details: • Suction gas temperature thermistor short or open detected
---	--

Forecast of Cause : <ol style="list-style-type: none"> 1. Connector connection defective, open 2. Thermistor defective 3. Main PCB defective
--

Check Point 1 : Check the connector connection and cable open
<input type="checkbox"/> Connector connection state check <input type="checkbox"/> Cable open check

↓ **OK**

Check Point 2 : Check the thermistor
<input type="checkbox"/> Thermistor characteristics check (Disconnect the thermistor from the PCB and check.) * For the thermistor characteristics, refer to the "Service Parts Information 22".

↓ **OK**

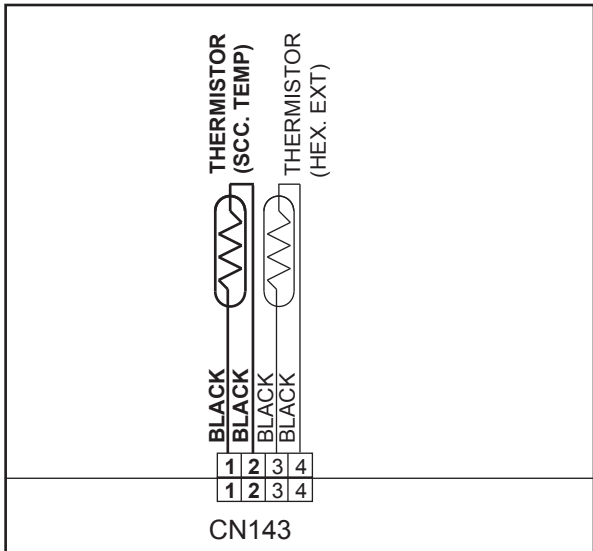
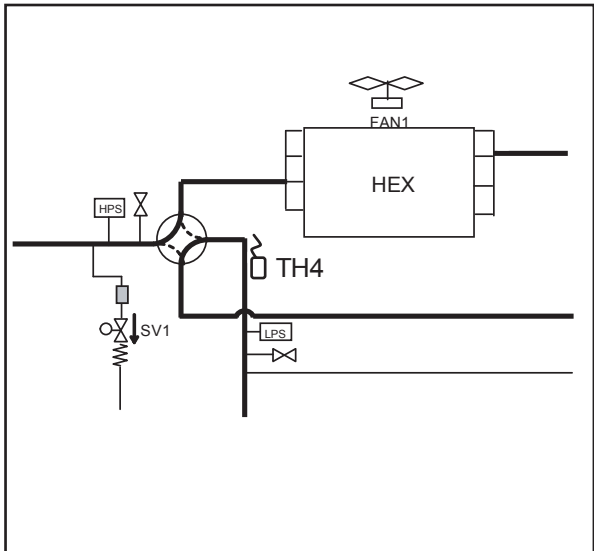
Check Point 3 : Check voltage of Main PCB (DC5.0V)	<div style="border: 1px solid black; padding: 5px; display: inline-block;"> DC  </div>
<input type="checkbox"/> Main PCB (CN143:1-2) voltage value = 5V <u>Remove the thermistor from Main PCB, check the voltage.</u>	
	
Suction gas temperature sensor (CN143:1-2)	
► If the voltage does not appear, replace Main PCB and set up original address. (Refer to 06-03 page Main PCB removal.)	

Trouble shooting 33 OUTDOOR UNIT Error Method: Heat Sink Temp Sensor Error	Indicate or Display: Outdoor Unit : E. 77. 1 Indoor Unit : Operation LED 9 times Flash, Timer LED 15 Times Flash, Filter LED Continuous Flash. Error Code : 77
---	---

Detective Actuators: Heat sink temperature thermistor	Detective details: • Heat sink temperature thermistor open/short detected
---	---

Forecast of Cause : <ol style="list-style-type: none"> 1. Connector connection defective, open 2. Thermistor defective 3. Inverter PCB defective
--

Check Point 1 : Check the connector connection and cable open
<input type="checkbox"/> Connector connection state check <input type="checkbox"/> Cable open check

↓ OK

Check Point 2 : Check the thermistor
<input type="checkbox"/> Thermistor characteristics check (Disconnect the thermistor from the PCB and check.) * For the thermistor characteristics, refer to the "Service Parts Information 22".

↓ OK

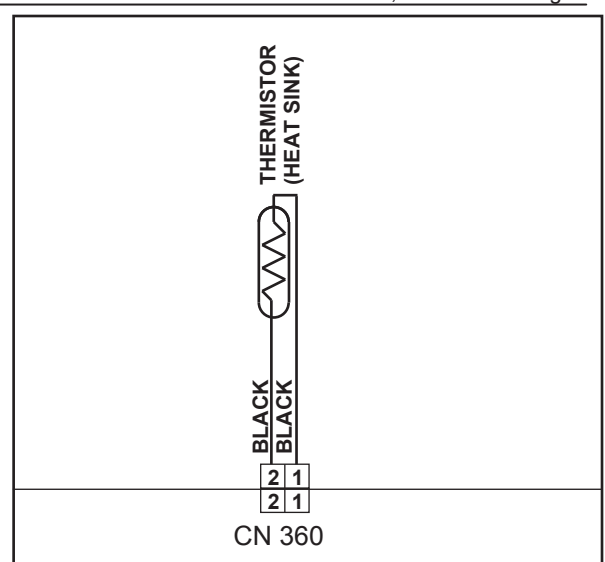
Check Point 3 : Check voltage of Inverter PCB (DC5.0V)	<div style="border: 1px solid black; padding: 2px; display: inline-block;">DC</div> 
<input type="checkbox"/> Inverter PCB (CN360:1-2) voltage value = 5V <u>Remove the thermistor from Inverter PCB, check the voltage.</u>	
	
Heat sink temperature thermistor (CN360:1-2)	
► If the voltage does not appear, replace Inverter PCB and set up original address.	

Trouble shooting 34 OUTDOOR UNIT Error Method: Sub-cool Heat EX. Gas Inlet Temp Sensor Error	Indicate or Display: Outdoor Unit : E. 82. 1 Indoor Unit : Operation LED 9 times Flash, Timer LED 15 Times Flash, Filter LED Continuous Flash. Error Code : 82
---	---

Detective Actuators: Sub-cooling heat exchanger gas inlet temperature thermistor	Detective details: • Sub-cooling heat exchanger gas inlet temperature thermistor short or open detected
--	---

Forecast of Cause :

1. Connector connection defective, open
2. Thermistor defective
3. Main PCB defective

Check Point 1 : Check the connector connection and cable open

Connector connection state check

Cable open check

↓
OK

Check Point 2 : Check the thermistor

Thermistor characteristics check (Disconnect the thermistor from the PCB and check.)

* For the thermistor characteristics, refer to the "Service Parts Information 22".

↓
OK

Check Point 3 : Check voltage of Main PCB (DC5.0V)

Main PCB (CN142:5-6) voltage value = 5V
Remove the thermistor from Main PCB, check the voltage.

DC



CN142

Sub-cooling heat exchanger gas inlet temperature sensor (CN142:5-6)

▶ **If the voltage does not appear, replace Main PCB and set up original address.**
(Refer to Refer to 06-03 page Main PCB removal.)

Trouble shooting 35 OUTDOOR UNIT Error Method: Sub-cool Heat EX. Gas outlet Temp Sensor Error	Indicate or Display: Outdoor Unit : E. 82. 2 Indoor Unit : Operation LED 9 times Flash, Timer LED 15 Times Flash, Filter LED Continuous Flash. Error Code : 82
--	---

Detective Actuators: Sub-cooling heat exchanger gas outlet temperature thermistor	Detective details: • Sub-cooling heat exchanger gas outlet temperature thermistor short or open detected
---	--

Forecast of Cause :

1. Connector connection defective, open
2. Thermistor defective
3. Main PCB defective

Check Point 1 : Check the connector connection and cable open

Connector connection state check
 Cable open check

↓
OK

Check Point 2 : Check the thermistor

Thermistor characteristics check (Disconnect the thermistor from the PCB and check.)
 * For the thermistor characteristics, refer to the "Service Parts Information 22".

↓
OK

Check Point 3 : Check voltage of Main PCB (DC5.0V)

Main PCB (CN142:7-8) voltage value = 5V
 Remove the thermistor from Main PCB, check the voltage.

DC



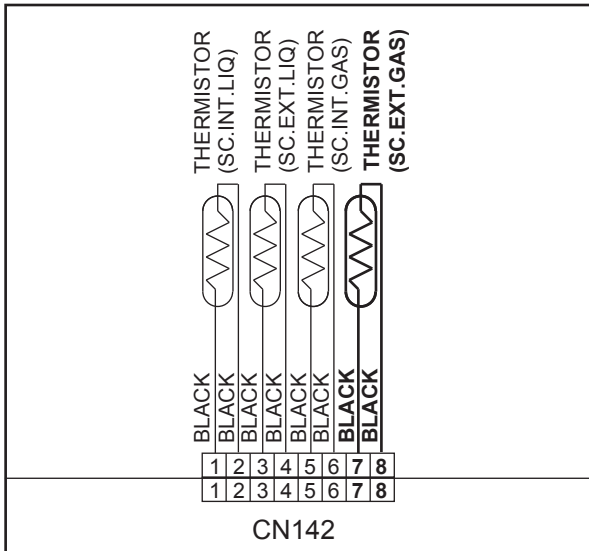

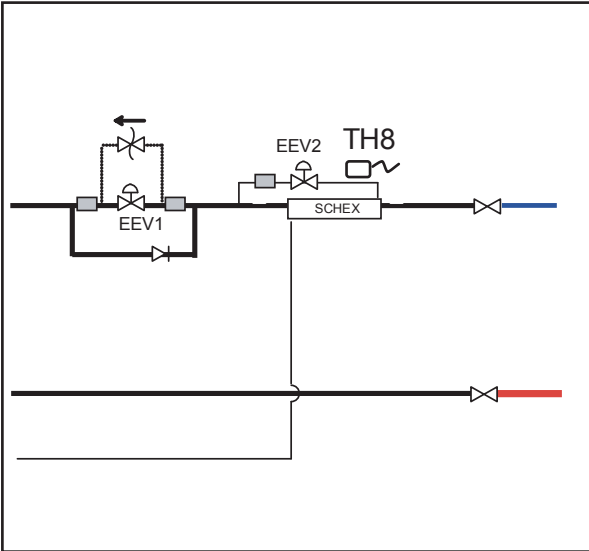

Sub-cooling heat exchanger gas outlet temperature sensor (CN142:7-8)

► **If the voltage does not appear, replace Main PCB and set up original address.**
(Refer to 06-03 page Main PCB removal.)

Trouble shooting 36 OUTDOOR UNIT Error Method: Liquid Pipe Temp. Sensor 1 Error	Indicate or Display: Outdoor Unit : E. 83. 1 Indoor Unit : Operation LED 9 times Flash, Timer LED 15 Times Flash, Filter LED Continuous Flash. Error Code : 83
--	---

Detective Actuators: Liquid pipe temperature thermistor 1	Detective details: • Liquid pipe temperature thermistor 1 short or open detected
---	--

Forecast of Cause : <ol style="list-style-type: none"> 1. Connector connection defective, open 2. Thermistor defective 3. Main PCB defective
--

Check Point 1 : Check the connector connection and cable open
<input type="checkbox"/> Connector connection state check <input type="checkbox"/> Cable open check

↓ **OK**

Check Point 2 : Check the thermistor
<input type="checkbox"/> Thermistor characteristics check (Disconnect the thermistor from the PCB and check.) * For the thermistor characteristics, refer to the "Service Parts Information 22".

↓ **OK**

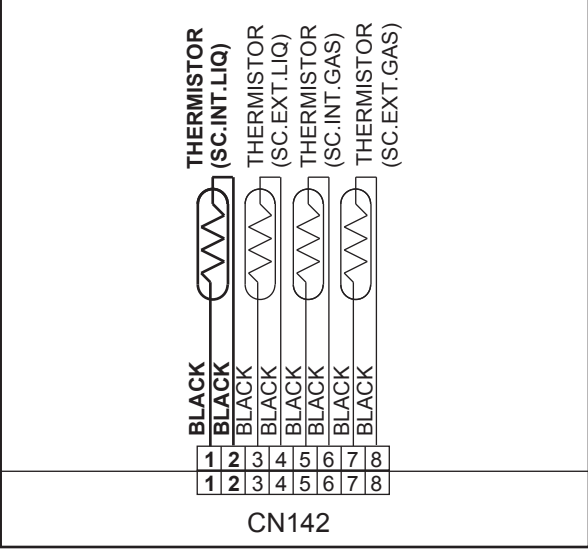
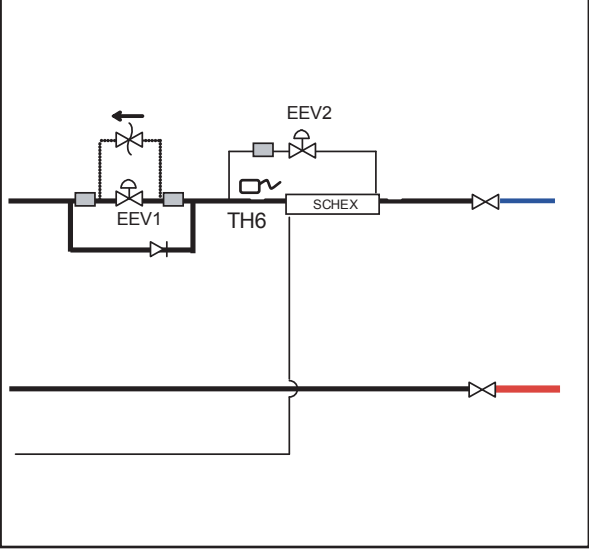
Check Point 3 : Check voltage of Main PCB (DC5.0V) <input type="checkbox"/> Main PCB (CN142:1-2) voltage value = 5V Remove the thermistor from Main PCB, check the voltage.	<div style="border: 1px solid black; padding: 2px; display: inline-block;"> DC  </div>
<div style="display: flex; justify-content: space-around;"> <div style="border: 1px solid black; padding: 5px; text-align: center;">  <p style="text-align: center;">CN142</p> </div> <div style="border: 1px solid black; padding: 5px;">  </div> </div>	
Liquid pipe temperature sensor 1 (CN142:1-2) ▶ If the voltage does not appear, replace Main PCB and set up original address. (Refer to 06-03 page Main PCB removal.)	

Trouble shooting 37 OUTDOOR UNIT Error Method: Liquid Pipe Temp Sensor 2 Error	Indicate or Display: Outdoor Unit : E. 83. 2 Indoor Unit : Operation LED 9 times Flash, Timer LED 15 Times Flash, Filter LED Continuous Flash. Error Code : 83
---	---

Detective Actuators: Liquid pipe temperature thermistor 2	Detective details: • Liquid pipe temperature thermistor 2 short or open detected
---	--

Forecast of Cause : <ol style="list-style-type: none"> 1. Connector connection defective, open 2. Thermistor defective 3. Main PCB defective
--

Check Point 1 : Check the connector connection and cable open
<input type="checkbox"/> Connector connection state check <input type="checkbox"/> Cable open check

↓ **OK**

Check Point 2 : Check the thermistor
<input type="checkbox"/> Thermistor characteristics check (Disconnect the thermistor from the PCB and check.) * For the thermistor characteristics, refer to the "Service Parts Information 22".

↓ **OK**

Check Point 3 : Check voltage of Main PCB (DC5.0V) <input type="checkbox"/> Main PCB (CN142:3-4) voltage value = 5V Remove the thermistor from Main PCB, check the voltage.	<div style="border: 1px solid black; padding: 5px; display: inline-block;"> DC </div>
<p style="text-align: center;">CN142</p>	
Liquid pipe temperature sensor 2 (CN142:3-4) ► If the voltage does not appear, replace Main PCB and set up original address. (Refer to 06-03 page Main PCB removal.)	

Trouble shooting 38 OUTDOOR UNIT Error Method: Current Sensor 1 Error	Indicate or Display: Outdoor Unit : E. 84. 1 Indoor Unit : Operation LED 9 times Flash, Timer LED 15 Times Flash, Filter LED Continuous Flash. Error Code : 84
--	---

Detective Actuators: Judgment from value sensed by current sensor 1 (current sensor for inverter) * Current sensor 1 is mounted on Filter PCB (INV)	Detective details: <ul style="list-style-type: none"> • "Protection stop by "inverter speed ≥ 50rps and sensor value 0A continued for 1 min"" was generated 2 times • Sensor value while inverter stopped = maximum was detected
--	--

Forecast of Cause : <ol style="list-style-type: none"> 1. Filter PCB (INV) to Inverter PCB CT system wiring connector disconnection, open 2. Power supply to Filter PCB (INV) to Inverter PC wiring disconnection, open 3. Filter PCB(INV) defective (Power supply section, current sensor section) 4. Inverter PCB defective
--

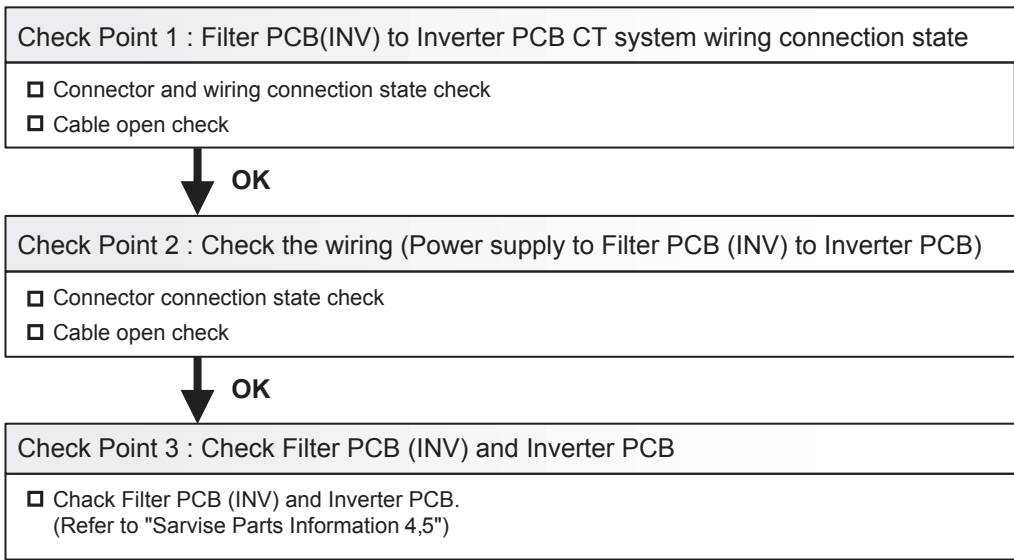

After fixing the problem and for canceling the Error, Error Reset (F3-40) will be required after power reset

Trouble shooting 39
OUTDOOR UNIT Error Method:
Discharge Pressure Sensor Error

Indicate or Display:
Outdoor Unit : E. 86. 1
Indoor Unit : Operation LED 9 times Flash, Timer LED 15 Times Flash, Filter LED Continuous Flash.
Error Code : 86

Detective Actuators:

Discharge pressure sensor

Detective details:

- When any of the following conditions is satisfied, a discharge pressure sensor error is generated.
 1. 30 seconds or more have elapsed since the outdoor unit power was turned on and pressure sensor detected value < 0.3V continued for 30 seconds or more
 2. 30 seconds or more have elapsed since the outdoor unit power was turned on and pressure sensor detected value \geq 5.0V was detected.

- Forecast of Cause :**
1. Discharge pressure sensor connector disconnection, open
 2. Discharge pressure sensor defective
 3. Main PCB defective

Check Point 1 : Check the discharge pressure sensor connection state

- Connector connection state check
- Cable open check



Check Point 2 : Check the discharge pressure sensor

- Sensor characteristics check
- * For the characteristics of the discharge pressure sensor, refer to the "Service Parts Information 20".



Check Point 3 : Check voltage of Main PCB (DC5.0V)

- Main PCB (CN118:1-3) voltage value = 5V
- Remove the connector from Main PCB, check the voltage

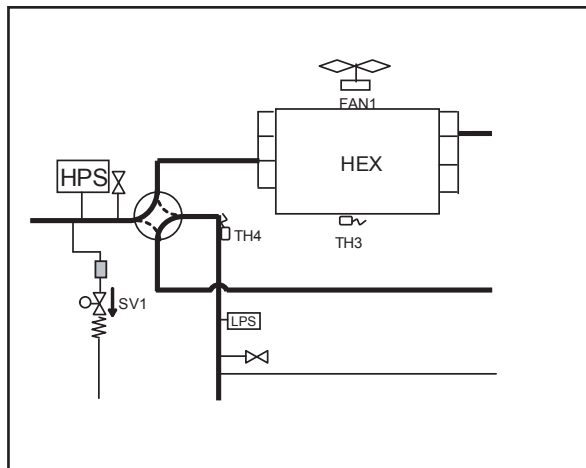
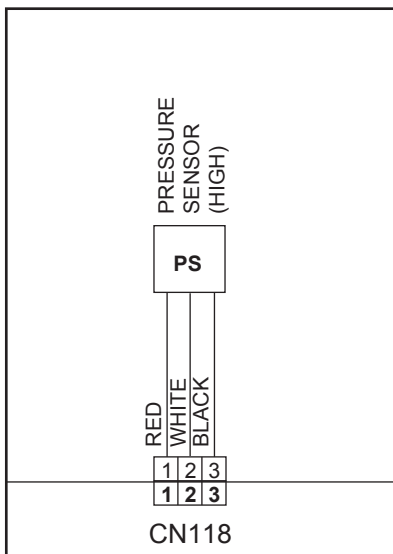

Discharge pressure sensor (CN118:1-3)

► **If the voltage does not appear, replace Main PCB and set up original address.**
 (Refer to 06-03 page Main PCB removal.)

Trouble shooting 40
OUTDOOR UNIT Error Method:
Suction Pressure Sensor Error

Indicate or Display:

Outdoor Unit : E. 86. 3
Indoor Unit : Operation LED 9 times Flash, Timer LED 15 Times Flash, Filter LED Continuous Flash.
Error Code : 86

Detective Actuators:

Suction pressure sensor

Detective details:

- When any of the following conditions is satisfied, a suction pressure sensor error is generated.
 1. 30 seconds or more have elapsed since the outdoor unit power was turned on and pressure sensor detected value < 0.06V continued for 30 seconds or more.
 2. 30 seconds or more have elapsed since the outdoor unit power was turned on and pressure sensor detected value $\geq 5.0V$ was detected.

- Forecast of Cause :**
1. Suction pressure sensor connector disconnection, open
 2. Suction pressure sensor defective
 3. Main PCB defective

Check Point 1 : Check the suction pressure sensor connection state

- Connector connection state check
- Cable open check



Check Point 2 : Check the suction pressure sensor

- Sensor characteristics check
- * For the characteristics of the suction pressure sensor, refer to the "Service Parts Information 20".



Check Point 3 : Check voltage of Main PCB (DC5.0V)

- Main PCB (CN119:1-3) voltage value = 5V
 Remove the connector from Main PCB, check the voltage.

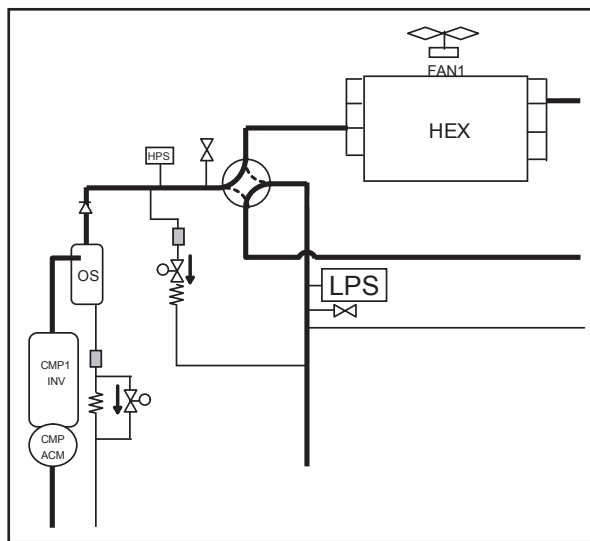
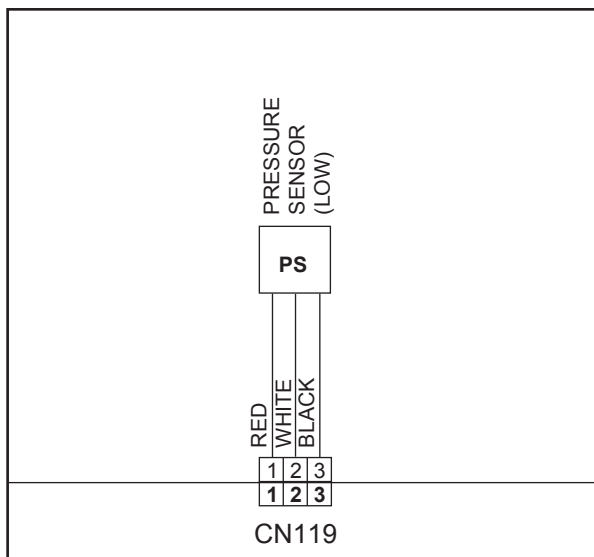

Suction pressure sensor (CN119:1-3)

► **If the voltage does not appear, replace Main PCB and set up original address.**
 (Refer to 06-03 page Main PCB removal.)

Trouble shooting 41 OUTDOOR UNIT Error Method: High Pressure Switch 1 Error	Indicate or Display: Outdoor Unit : E. 86. 4 Indoor Unit : Operation LED 9 times Flash, Timer LED 15 Times Flash, Filter LED Continuous Flash. Error Code : 86
--	---

<u>Detective Actuators:</u> High pressure switch 1	<u>Detective details:</u> • When the power was turned on, "high pressure switch 1: open" was detected.
--	--

<u>Forecast of Cause :</u> <ol style="list-style-type: none"> 1. High pressure switch 1 connector disconnection, open 2. High pressure switch 1 characteristics defective 3. Main PCB defective

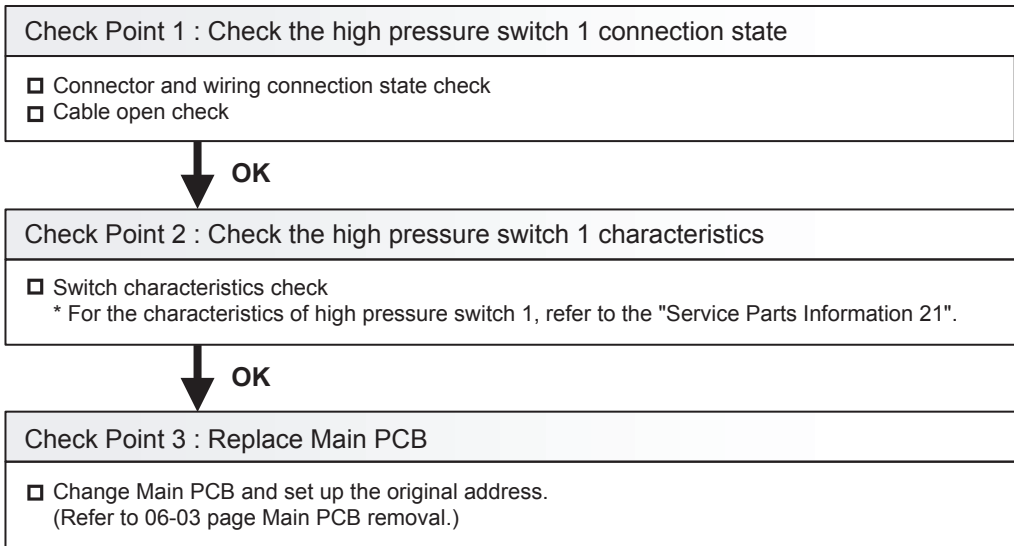

Trouble shooting 42 OUTDOOR UNIT Error Method: Inverter Compressor Start UP Error	Indicate or Display: Outdoor Unit : E. 93. 1 Indoor Unit : Operation LED 9 times Flash, Timer LED 15 Times Flash, Filter LED Continuous Flash. Error Code : 93
--	---

Detective Actuators: Inverter PCB	Detective details: <ul style="list-style-type: none"> ▪ "Protection stop by "overcurrent generation at inverter compressor starting" ⇒ restart" generated consecutively 60 times x 2 sets (total 120 times) * The shortest time up to error generation is about 100 minutes * Restart is not performed if an indoor unit in the same refrigerant system is not turned ON by thermostat. * After the end of the 1st set, the 2nd set is not started if all the compressors in the same refrigerant system are not temporarily stopped.
---	--

Forecast of Cause : <ol style="list-style-type: none"> 1. Inverter PCB to inverter compressor wiring disconnection, open 2. Inverter PCB defective 3. Inverter compressor defective (lock, winding short)

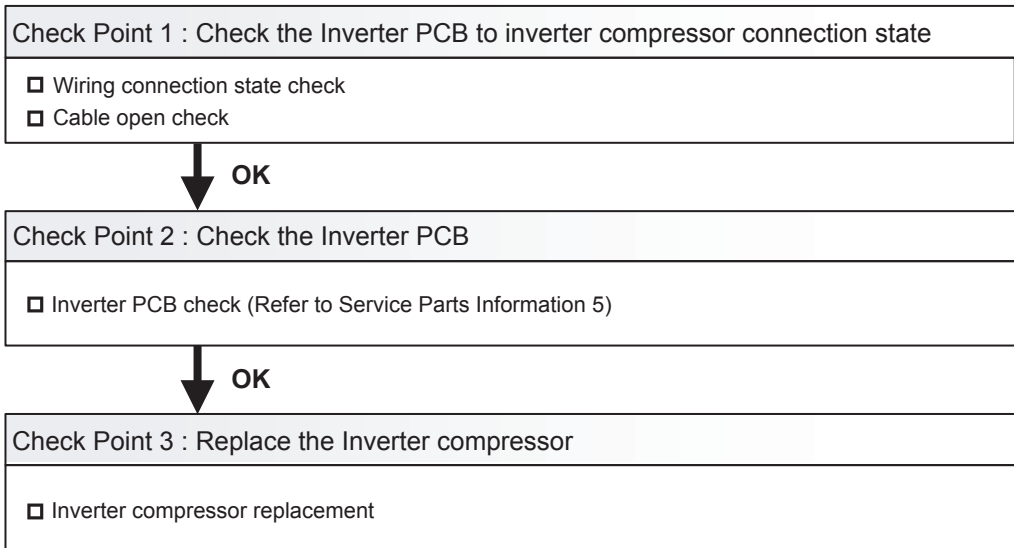

After fixing the problem and for canceling the Error, Error Reset (F3-40) will be required after power reset

Trouble shooting 43 OUTDOOR UNIT Error Method: Trip Detection	Indicate or Display: Outdoor Unit : E. 94. 1 Indoor Unit : Operation LED 9 times Flash, Timer LED 15 Times Flash, Filter LED Continuous Flash. Error Code : 94
--	---

Detective Actuators: Inverter PCB	Detective details: <ul style="list-style-type: none"> ▪ "Protection stop by "overcurrent generation after inverter compressor start processing completed"" generated consecutively 5 times. * The number of generations is reset if protection stop is not generated again within 40 seconds after restarting.
---	--

Forecast of Cause : <ol style="list-style-type: none"> 1. Outdoor unit fan operation defective, foreign matter on heat exchanger, excessive rise of ambient temperature 2. Inverter PCB defective 3. Inverter compressor defective (lock, winding short)
--

Check Point 1 : Check the outdoor unit fan operation, heat exchanger, ambient temperature
<input type="checkbox"/> No obstructions in air passages? <input type="checkbox"/> Heat exchange fins clogged <input type="checkbox"/> Outdoor unit fan motor check <input type="checkbox"/> Ambient temperature not raised by the effect of other heat sources? <input type="checkbox"/> Discharged air not sucked in?



Check Point 2 : Check the Inverter PCB
<input type="checkbox"/> Inverter PCB check (Refer to Service Parts Information 5)



Check Point 3 : Replace the Inverter compressor
<input type="checkbox"/> Inverter compressor replacement

After fixing the problem and for canceling the Error, Error Reset (F3-40) will be required after power reset

Trouble shooting 44 OUTDOOR UNIT Error Method: Compressor Motor Loss of Synchronization	Indicate or Display: Outdoor Unit : E. 95. 5 Indoor Unit : Operation LED 9 times Flash, Timer LED 15 Times Flash, Filter LED Continuous Flash. Error Code : 95
--	---

Detective Actuators: Inverter PCB	Detective details: <ul style="list-style-type: none"> ▪ "Protection stop by "loss of synchronization detection"" generated consecutively 5 times * The number of generations is reset if protection stop is not generated again within 40 seconds after restarting.
---	---

Forecast of Cause : <ol style="list-style-type: none"> 1. Inverter PCB defective 2. Inverter compressor defective (lock)

Check Point 1 : Check the Inverter PCB
<input type="checkbox"/> Inverter PCB check (Refer to Service Parts Information 3.4)



Check Point 2 : Replace the Inverter compressor
<input type="checkbox"/> Inverter compressor replacement

After fixing the problem and for canceling the Error, Error Reset (F3-40) will be required after power reset

Trouble shooting 45 <u>OUTDOOR UNIT Error Method:</u> Outdoor Unit Fan Motor Lock Error	<u>Indicate or Display:</u> Outdoor Unit : E. 97. 1 Indoor Unit : Operation LED 9 times Flash, Timer LED 15 Times Flash, Filter LED Continuous Flash. Error Code : 97
--	--

<u>Detective Actuators:</u> Outdoor unit fan	<u>Detective details:</u> <ul style="list-style-type: none"> ▪ "Protection stop by "fan speed \leq 100rpm" 20 seconds after fan operation command issued" was generated consecutively 5 times * The compressor is protection stopped every time fan protection stop has been generated 3 times.
--	--

<u>Forecast of Cause :</u> <ol style="list-style-type: none"> 1. Rotation obstruction by foreign matter 2. Motor wiring, connector disconnection, open 3. Fan motor defective (winding open, lock) 4. Main PCB defective (drive circuit, speed detection circuit)
--

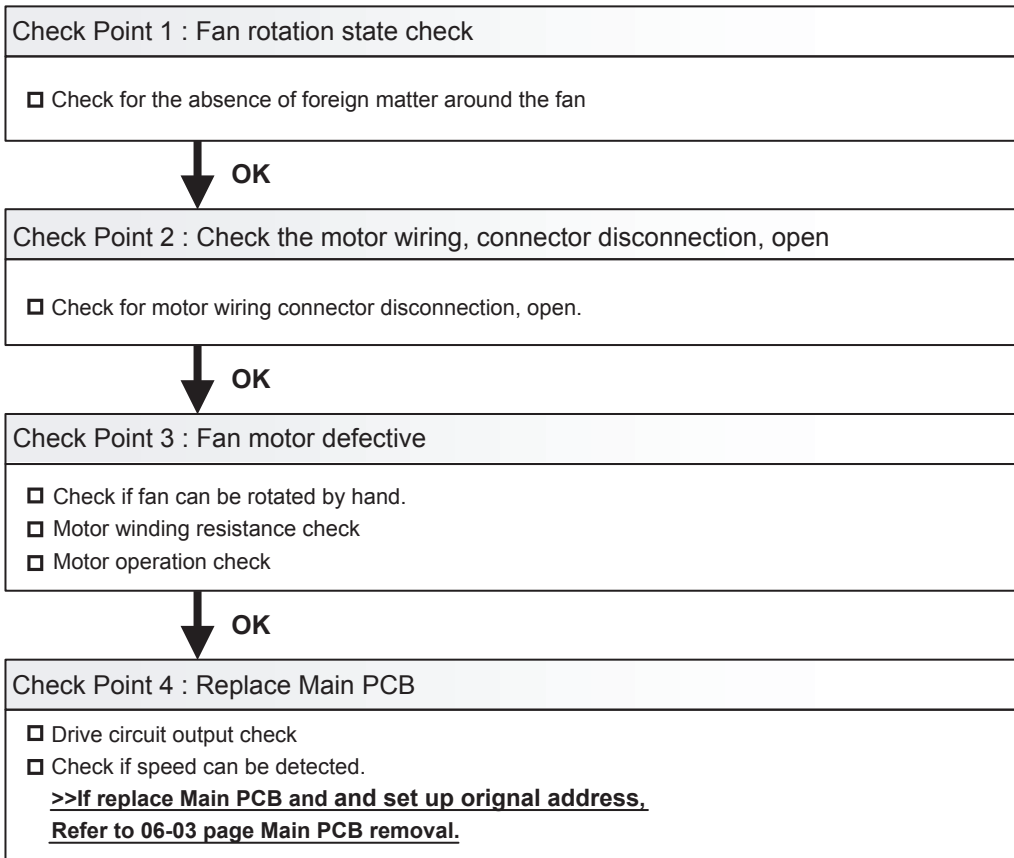

After fixing the problem and for canceling the Error, Error Reset (F3-40) will be required after power reset

Trouble shooting 46 OUTDOOR UNIT Error Method: Outdoor Unit Fan Motor Undervoltage	Indicate or Display: Outdoor Unit : E. 97. 4 Indoor Unit : Operation LED 9 times Flash, Timer LED 15 Times Flash, Filter LED Continuous Flash. Error Code : 97
---	---

Detective Actuators: Outdoor unit main	Detective details: ▪ Low DC power supply (DC voltage 195V or less) detected
--	---

Forecast of Cause :	1. Power OFF, voltage drop, momentary open 2. Power supply wiring connection defective, open 3. Main PCB defective (electrolytic capacitor, DC voltage detection circuit)
----------------------------	---

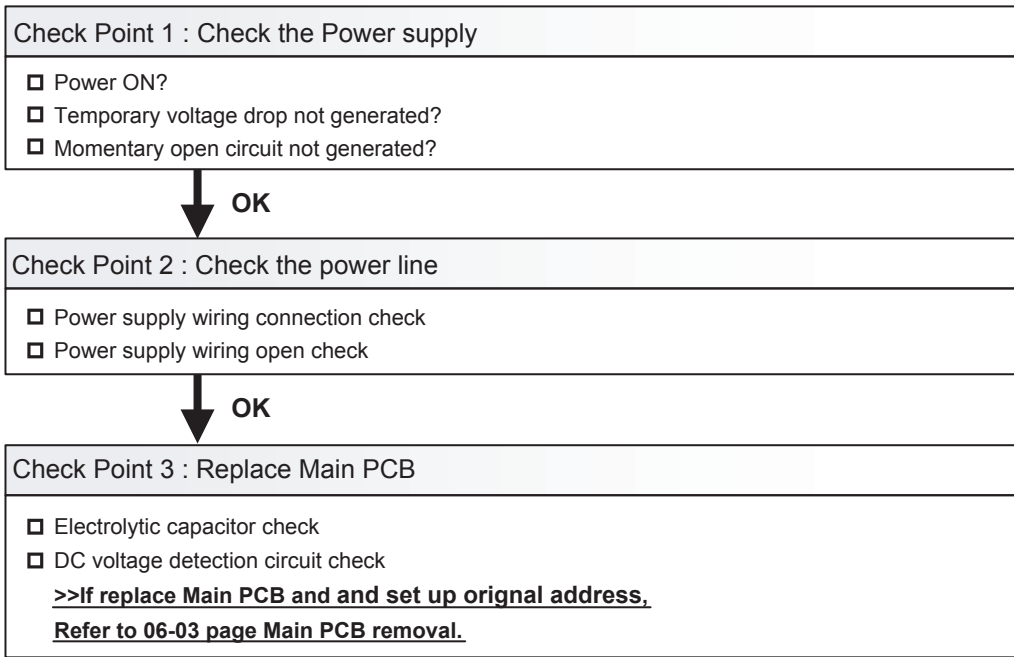

Trouble shooting 47 OUTDOOR UNIT Error Method: Outdoor Unit Fan Motor Temperature Abnormal	Indicate or Display: Outdoor Unit : E. 97. 5 Indoor Unit : Operation LED 9 times Flash, Timer LED 15 Times Flash, Filter LED Continuous Flash. Error Code : 97
---	---

Detective Actuators: Outdoor unit fan	Detective details: <ul style="list-style-type: none"> ▪ Protection stop "When the abnormal temperature protection which detected by the internal device in the FAN motor PCB." by fan speed $\leq 270\text{rpm}^*$ after 60 seconds have elapsed after fan operation command issued generated 3 times within 3 hours. <p style="text-align: right;">*270rpm: Criteria for stop condition</p>
---	--

Forecast of Cause :	<ol style="list-style-type: none"> 1. Rotation obstructed by foreign matter 2. Ventilation obstructed by heat exchange foreign matter 3. Excessive ambient temperature rise 4. Static pressure setting incorrect, specified static pressure value exceeded 5. Fan motor defective (internal PCB defective)
----------------------------	---

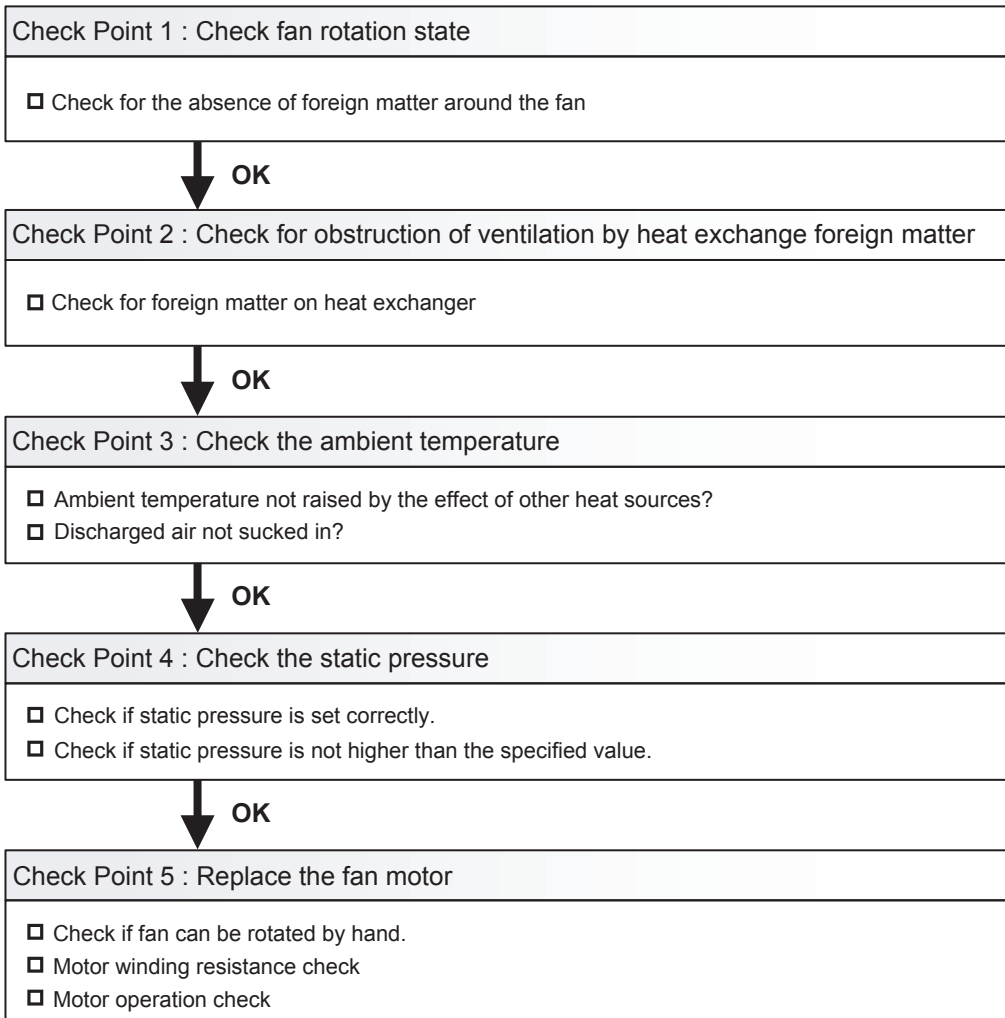

Trouble shooting 48 OUTDOOR UNIT Error Method: Coil EEV1 Error Coil EEV2 Error	Indicate or Display: Outdoor Unit : E. 9A. 1 (EEV1), E. 9A. 2 (EEV2) Indoor Unit : Operation LED 9 times Flash, Timer LED 15 Times Flash, Filter LED Continuous Flash. Error Code : 9A
---	---

Detective Actuators: Main PCB	Detective details: ▪ When the EEV input on the Main PCB (CN116, CN117) was open circuit or short circuit.
---	---

Forecast of Cause :
1. EEV coil lose connection 2. EEV wire(s) cut or pinched 4. Defective EEV coil 3. Main PCB (DC 12V) output abnormal

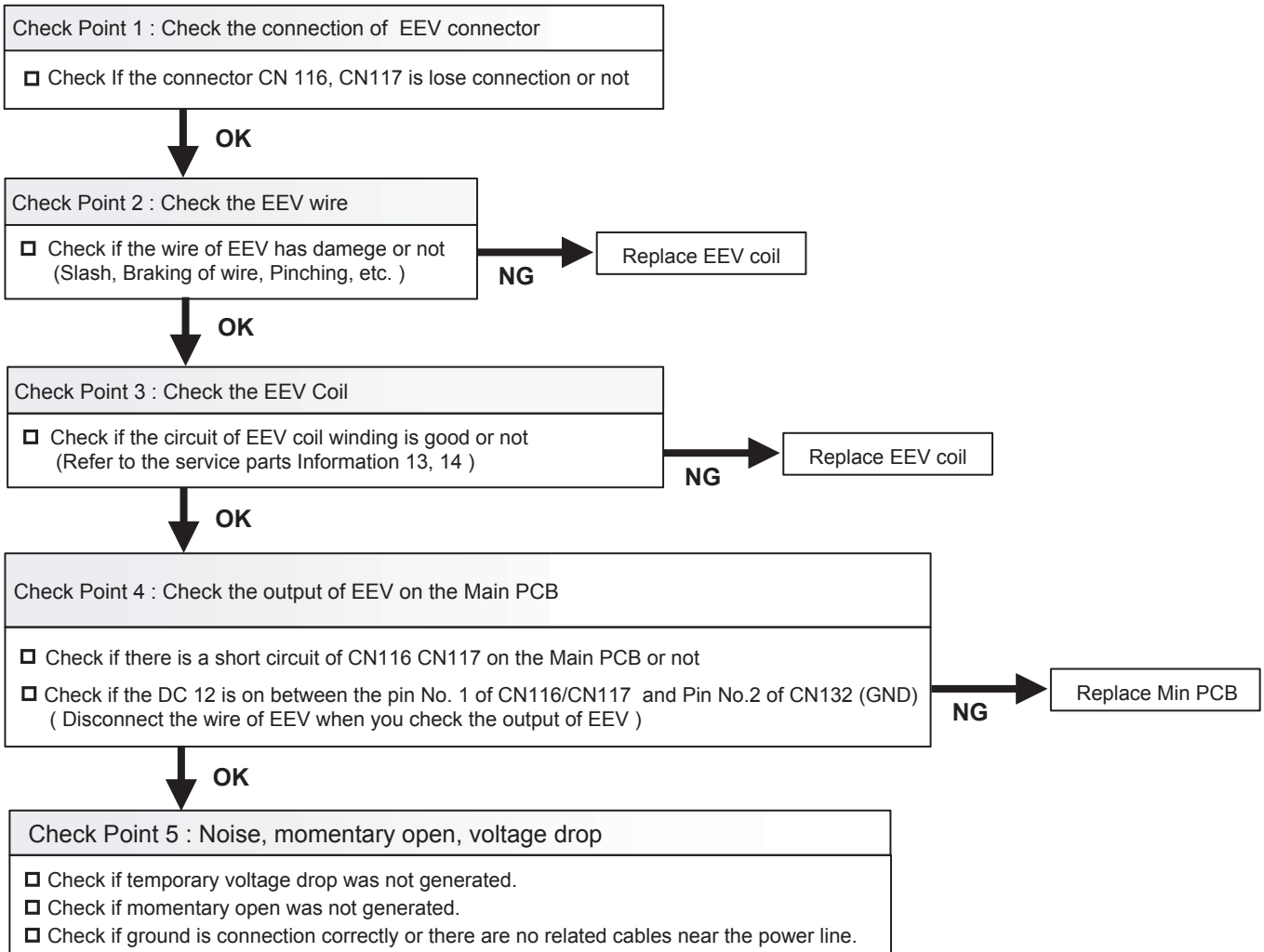

<p>Trouble shooting 49 <u>OUTDOOR UNIT Error Method:</u> Slave Unit Error</p>	<p><u>Indicate or Display:</u> Outdoor Unit : E. 9U. 2 Indoor Unit : No display Error Code : 9U</p>
--	--

<p><u>Detective Actuators:</u> Slave Unit</p>	<p><u>Detective details:</u> <ul style="list-style-type: none"> ▪ Error signal received from slave unit of same refrigerant system </p>
---	--

<p>Check Point 1 : Check the slave unit</p>
<p><input type="checkbox"/> Slave unit 7 seg display check ⇒ Check by troubleshooting based on displayed error code.</p>

Trouble shooting 50 OUTDOOR UNIT Error Method: Discharge Temperature 1 Abnormal	Indicate or Display: Outdoor Unit : E. A1. 1 Indoor Unit : Operation LED 9 times Flash, Timer LED 15 Times Flash, Filter LED Continuous Flash. Error Code : A1
--	---

Detective Actuators: Discharge temperature thermistor 1	Detective details: • "Protection stop by "discharge temperature1 \geq 230°F (110°C) during compressor 1 operation"" generated 2 times within 40 minutes.
---	--

Forecast of Cause : <ol style="list-style-type: none"> 1. 3-way valve not opened 2. EEV defective, strainer clogged 3. Outdoor unit operation defective, foreign matter on heat exchanger 4. Discharge temperature thermistor 1 defective 5. Insufficient refrigerant

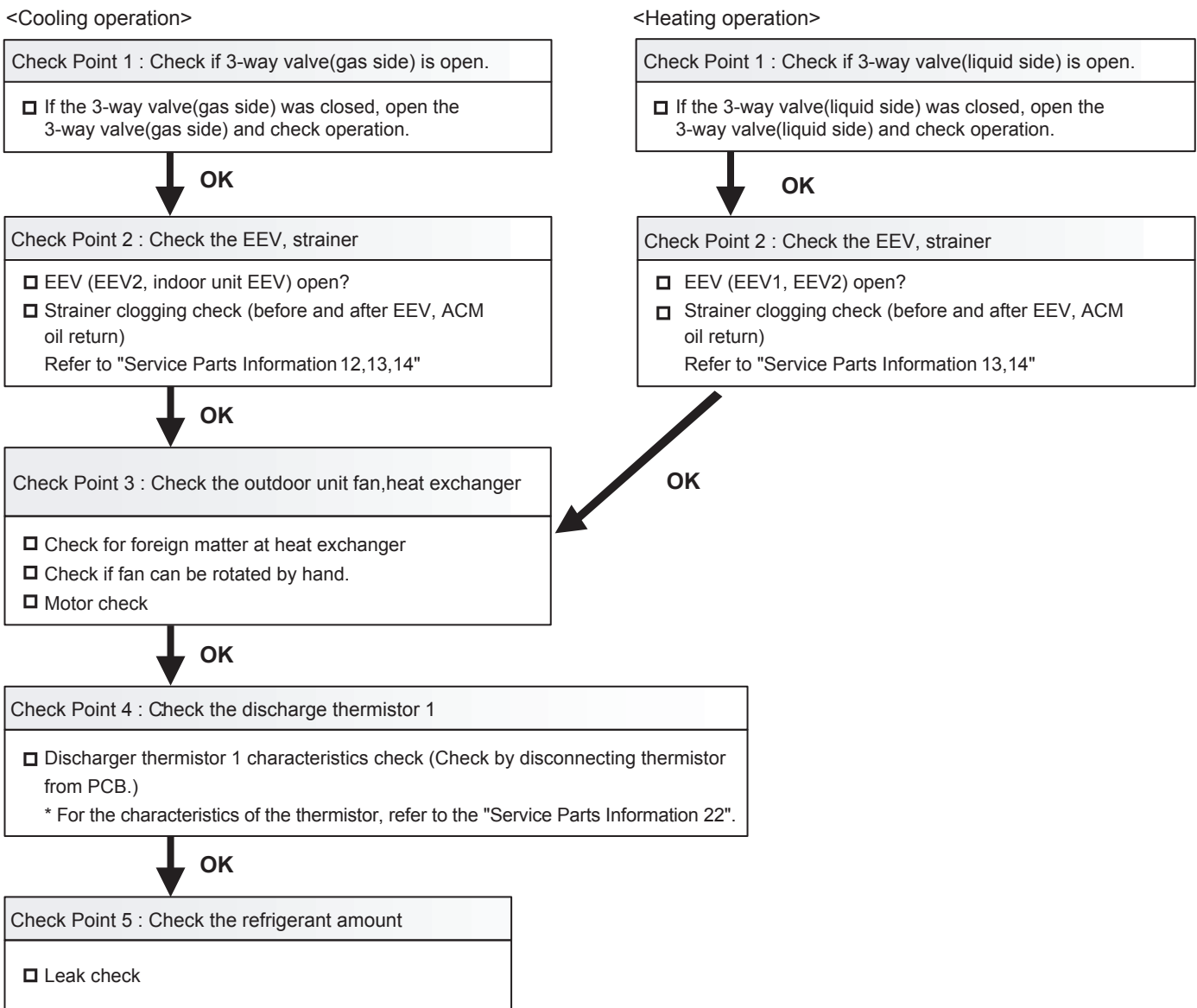

After fixing the problem and for canceling the Error, Error Reset (F3-40) will be required after power reset

Trouble shooting 51 OUTDOOR UNIT Error Method: Compressor 1 Temperature Abnormal	Indicate or Display: Outdoor Unit : E. A3. 1 Indoor Unit : Operation LED 9 times Flash, Timer LED 15 Times Flash, Filter LED Continuous Flash. Error Code : A3
---	---

Detective Actuators: Compressor temperature thermistor 1	Detective details: • "Protection stop by "compressor 1 temperature" $\geq 234^{\circ}\text{F}$ (112°C) during compressor 1 operation" generated 2 times within 40 minutes.
--	--

Forecast of Cause : <ol style="list-style-type: none"> 1. 3-way valve not opened 2. EEV defective, strainer clogged 3. Outdoor unit operation defective, foreign matter on heat exchanger 4. Compressor 1 temperature thermistor defective 5. Insufficient refrigerant
--

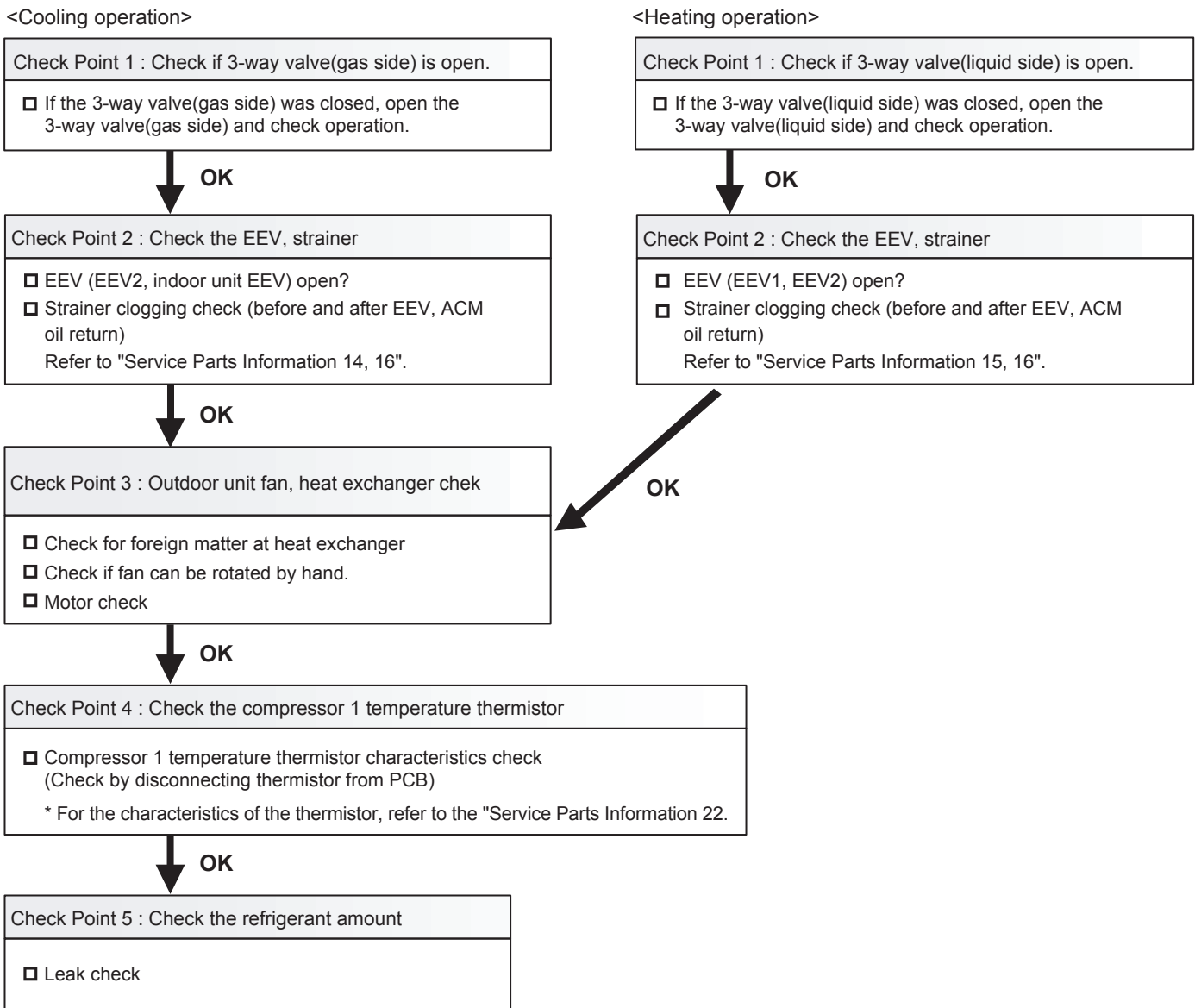

After fixing the problem and for canceling the Error, Error Reset (F3-40) will be required after power reset

Trouble shooting 52 OUTDOOR UNIT Error Method: High Pressure Abnormal	Indicate or Display: Outdoor Unit : E. A4. 1 Indoor Unit : Operation LED 9 times Flash, Timer LED 15 Times Flash, Filter LED Continuous Flash. Error Code : A4
--	---

Detective Actuators: Judgment from value sensed by discharge pressure sensor	Detective details: ▪ "Protection stop by "discharge pressure \geq 580psi (4.00MPa) during operation of any compressor"" generated 3 times within 60 minutes.
--	--

Forecast of Cause : 1. 3-way valve not opened 2. Outdoor unit fan operation defective, foreign matter at heat exchanger, excessive ambient temperature rise 3. Check valve clogged
 4. EEV defective, strainer clogged 5. Solenoid valve defective
 6. Discharge pressure sensor defective 7. Refrigerant overcharged

<Cooling operation>

Check Point 1 : Check if 3-way valve(liquid side) is open.
 If the 3-way valve(liquid side) was closed, open the 3-way valve(liquid side) and check operation.



Check Point 2 : Check the outdoor unit fan operation, heat exchanger, ambient temperature
 No foreign matter in air passage?
 Heat exchange fins clogged
 Outdoor unit fan motor check
 Ambient temperature not raised by effect of other heat sources?
 Discharged air not sucked in?



Check Point 3 : Check the check valve
 Check if check valve (parallel with EEV1) not clogged.



Check Point 5 : Check the solenoid valve (SV1, SV2)
 Solenoid valve operation check
 Refer to "Service Parts Information 15".



Check Point 6 : Check the discharge pressure sensor
 Discharge pressure sensor characteristics check
 * For the characteristics of the discharge pressure sensor, refer to "Service Parts Information 20".



Check Point 7 : Check the refrigerant amount
 Refrigerant charged amount check

<Heating operation>

Check Point 1 : Check if 3-way valve(gas side) is open.
 If the 3-way valve(gas side) was closed, open the 3-way valve(gas side) and check operation.



Check Point 4 : Check the EEV, strainer (indoor unit)
 EEV operation check
 Check of strainers before and after EEV
 Refer to "Service Parts Information 12 ".

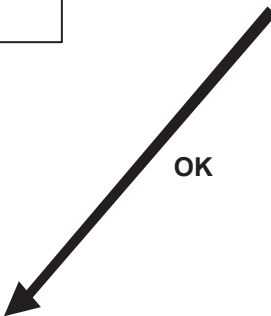

Trouble shooting 53 OUTDOOR UNIT Error Method: High Pressure Protection 1	Indicate or Display: Outdoor Unit : E. A4. 2 Indoor Unit : Operation LED 9 times Flash, Timer LED 15 Times Flash, Filter LED Continuous Flash. Error Code : A4
--	---

Detective Actuators: High pressure switch 1	Detective details: ▪ "Protection stop by "high pressure switch 1 operated during compressor 1 operation"" generated 3 times within 60 minutes
---	---

Forecast of Cause :	1. 3-way valve not opened 2. Outdoor unit fan operation defective, foreign matter at heat exchanger, excessive ambient temperature rise 3. Check valve clogged 4. EEV defective, strainer clogged 5. Solenoid valve defective 6. High pressure switch 1 defective 7. Refrigerant overcharged
----------------------------	--

<Cooling operation>

Check Point 1 : Check if 3-way valve(liquid side) is open.
<input type="checkbox"/> If the 3-way valve(liquid side) was closed, open the 3-way valve(liquid side) and check operation.

↓ **OK**

Check Point 2 : Check the outdoor unit fan operation, heat exchanger, ambient temperature
<input type="checkbox"/> No foreign matter in air passage? <input type="checkbox"/> Heat exchange fins clogged <input type="checkbox"/> Outdoor unit fan motor check <input type="checkbox"/> Ambient temperature not raised by effect of other heat sources? <input type="checkbox"/> Discharged air not sucked in?

↓ **OK**

Check Point 3-1 : Check the check valve
<input type="checkbox"/> Check if check valve (parallel with EEV1) not clogged.

↓ **OK**

Check Point 3-2 : Check the check valve
<input type="checkbox"/> Check if check valve (oilseparator (out) of compressor 1) is not clogged.

↓ **OK**

Check Point 5 : Check the solenoid valve (SV1, SV2)
<input type="checkbox"/> Solenoid valve operation check Refer to "Service Parts Information 15".

↓ **OK**

Check Point 6 : Check high pressure switch 1
<input type="checkbox"/> High pressure switch 1 characteristics check * For the characteristics of the high pressure switch 1, refer to "Service Parts Information 21".

↓ **OK**

Check Point 7 : Check the refrigerant amount
<input type="checkbox"/> Refrigerant charged amount check

<Heating operation>

Check Point 1 : Check if 3-way valve(gas side) is open.
<input type="checkbox"/> If the 3-way valve(gas side) was closed, open the 3-way valve(gas side) and check operation.

↓ **OK**

Check Point 4 : Check the EEV, strainer (indoor unit)
<input type="checkbox"/> EEV operation check <input type="checkbox"/> Check of strainers before and after EEV Refer to "Service Parts Information 12 ".

↙ **OK**

Trouble shooting 54 OUTDOOR UNIT Error Method: Low Pressure Abnormal	Indicate or Display: Outdoor Unit : E. A5. 1 Indoor Unit : Operation LED 9 times Flash, Timer LED 15 Times Flash, Filter LED Continuous Flash. Error Code : A5
---	---

Detective Actuators: Suction pressure sensor	Detective details: <ul style="list-style-type: none"> ▪ "Protection stop by "suction pressure \leq 15psi (0.10MPa) continued for 10 minutes" or "suction pressure \leq 7psi (0.05MPa)" during operation of any compressor"" was generated 5 times within 3 hours.
--	--

Forecast of Cause :	1. 3-way valve not opened 2. Outdoor unit ambient temperature too low 3. Outdoor unit fan operation defective, foreign matter at heat exchanger 4. EEV defective, strainer clogged 5. Solenoid valve defective 6. Low pressure sensor characteristics defective 7. Insufficient refrigerant
----------------------------	--

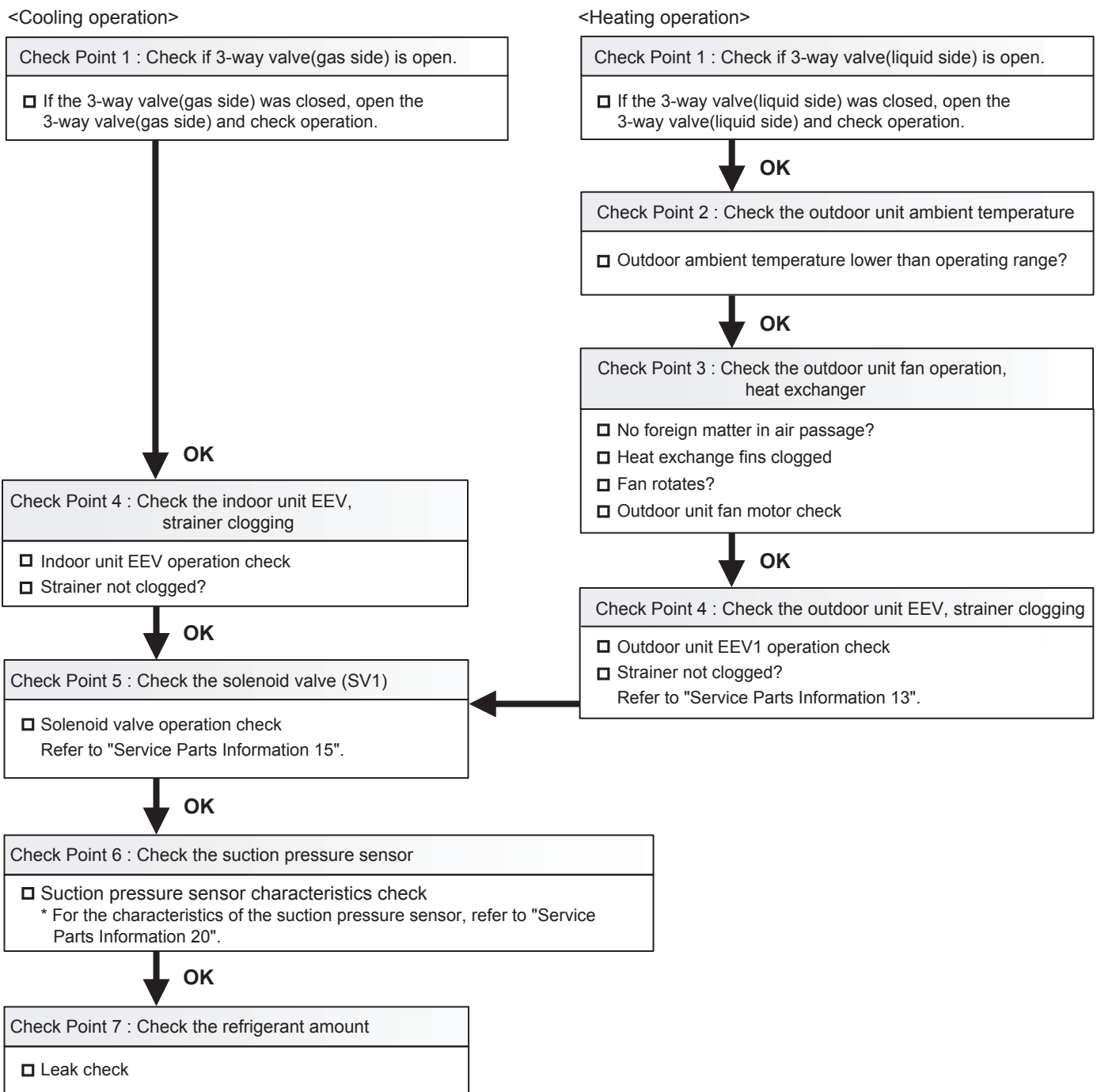

After fixing the problem and for canceling the Error, Error Reset (F3-40) will be required after power reset

Trouble shooting 55 OUTDOOR UNIT Error Method: Heat Sink Temperature Abnormal	Indicate or Display: Outdoor Unit : E. AC. 4 Indoor Unit : Operation LED 9 times Flash, Timer LED 15 Times Flash, Filter LED Continuous Flash. Error Code : AC
--	---

Detective Actuators: Heat sink thermistor	Detective details: <ul style="list-style-type: none"> ▪ "Protection stop by "heat sink temperature $\geq 190^{\circ}\text{F}$ (88°C)" generated 3 times within 60 minutes.
---	---

Forecast of Cause :	1. Foreign matter on heat sink, heat sink dirty 2. Foreign matter on heat exchanger, excessive ambient temperature rise 3. Heat sink thermistor defective
----------------------------	---

Check Point 1 : Check the heat sink state
<input type="checkbox"/> Heat sink foreign matter, soiling check



Check Point 2 : Check the foreign matter and ambient temperature of heat exchanger
<input type="checkbox"/> Heat exchange foreign matter check <input type="checkbox"/> Ambient temperature not raised by effect of other heat sources? <input type="checkbox"/> Discharged air not sucked in?



Check Point 3 : Check the heat sink thermistor
<input type="checkbox"/> Heat sink thermistor characteristics check (Check by disconnecting thermistor from PCB.) * For the characteristics of the thermistor, refer to "Service Parts Information 22".

TROUBLE SHOOTING WITH NO ERROR CODE

Trouble shooting 56 Indoor Unit - No Power

Forecast of Cause :

1. Power Supply failure 2. Outside cause 3. Electrical Component defective

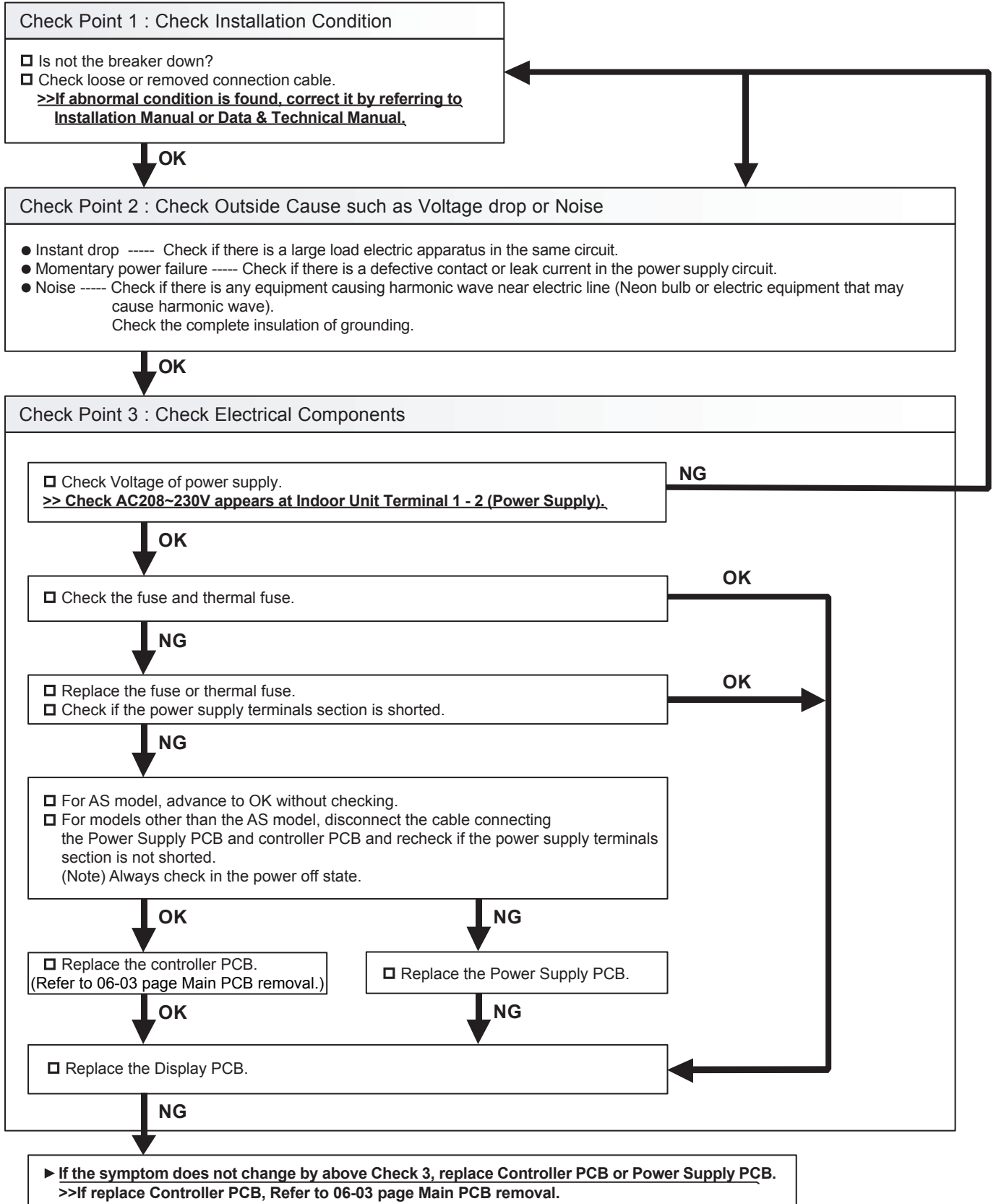

Trouble shooting 57
Outdoor Unit - No Power

Forecast of Cause :

1. Power Supply failure 2. Outside cause 3. Electrical Components defective

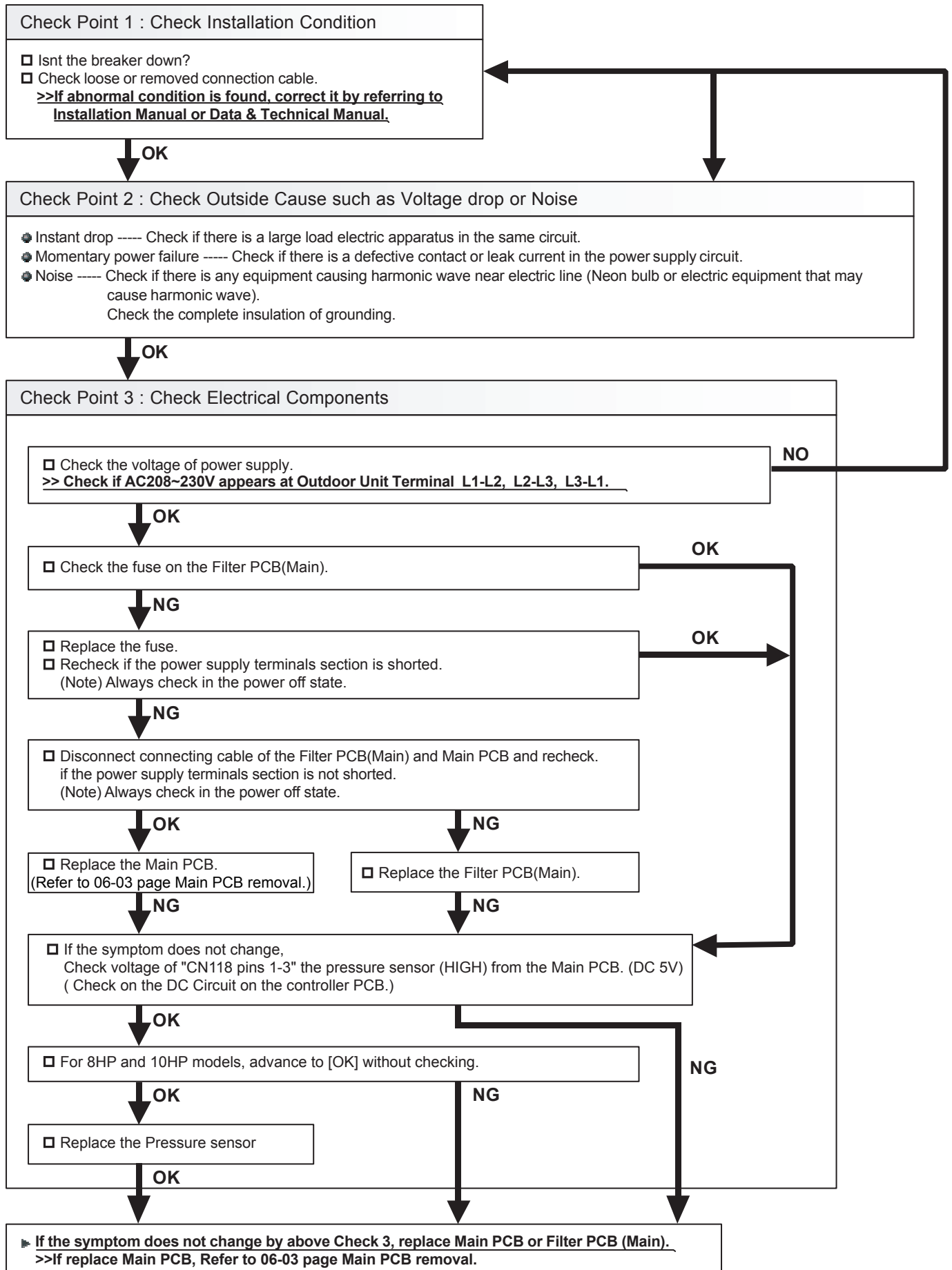

Trouble shooting 58

No Operation (Power is ON)

Forecast of Cause :

1. Setting/Connection failure
2. Outside cause
3. Electrical Component defective

Check Point 1 : Check indoor and outdoor installation condition

- Indoor Unit - Check incorrect wiring between Indoor Unit- Remote Control, or terminals between Indoor Units.
Or, check if there is an open cable connection.
 - Check address setting (Are all the address of Indoor and Outdoor correct?)
 - Are these Indoor Unit, Outdoor Unit, and Remote Control suitable model numbers to connect?
- >> If there is some abnormal condition, correct it by referring to Installation manual and Data & Technical Manual.**

OK

Turn off Power and check/correct followings.

- Isn't Communication PCB of Indoor Unit removed?
- Is there loose or removed communication line of Indoor Unit and Outdoor Unit?
- Check Terminator (DIP-SW SET 5) is installed on Outdoor Main PCB.
- Check loose or removed communication line between each Outdoor Unit.
- Check loose Communication PCB of each Outdoor Unit.

OK

Check Point 2 : Check outside cause at Indoor and Outdoor (Voltage drop or Noise)

- Instant drop -----Check if there is a large load electric apparatus in the same circuit.
- Momentary power failure ----- Check if there is a defective contact or leak current in the power supply circuit.
- Noise ----- Check if there is any equipment causing harmonic wave near electric line (Neon bulb or electric equipment that may cause harmonic wave).
Check the complete insulation of grounding.

OK

Check Point 3 : Check Electrical Components at Indoor and Outdoor



- Indoor Unit - Check the voltage between pins 1-3 of the connector (on the control PCB) for connection with the remote controller.
>> If it is DC12V, Remote Control is defective (Controller PCB is normal) >> Replace Remote Control
>> If it is DC 0V, Controller PCB is defective (Check Remote Control once again) >> Replace Controller PCB
- If some of Indoor unit does not operate, replace the Communication PCB of the non-operative Indoor Unit.
>> If the symptom does not change, replace Controller PCB of Indoor Unit.
- If all of Indoor Units do not operate, check the connection between Main PCB and Communication PCB of Outdoor Unit (Main Unit).
>> If the symptom does not change, replace Communication PCB of Outdoor Unit (Main Unit).
(If it did not work, replace Main PCB.)

Trouble shooting 59

No Cooling

Forecast of Cause :

1. Indoor Unit error
2. Outdoor Unit error
3. Effect by Surrounding environment
4. Connection Pipe / Connection Wire failure
5. Refrigeration cycle failure

Check Point 1 : Check Indoor Unit

- Does Indoor Unit FAN run on HIGH FAN?
- Is Air Filter dirty?
- Is Heat Exchanger clogged?

↓
OK

Check Point 2 : Check Outdoor Unit Operation

- Check if Outdoor Unit is operating
- Check any objects that obstruct the air flow route.
- Check clogged Heat Exchanger.
- Is the pipe length setting (Push Switch "MODE/EXIT", "SELECT", "ENTER") suitable?
- Is the Valve open?

↓
OK

Check Point 3 : Check Site Condition

- Is capacity of Indoor Unit fitted to Room size?
- Any windows open? Or direct sunlight ?

↓
OK

Check Point 4 : Check Indoor/Outdoor Installation Condition

- Check connection pipe (specified pipe length & Pipe diameter?)
 - Check any loose or removed communication line.
- >> If there is an abnormal condition, correct it by referring to Installation Manual or Data & Technical Manual.**

↓
OK

Check Point 5 : Check Refrigeration Cycle

- Check if Strainer is clogged (Refer to the figure at right).
- Measure Gas Pressure and if there is a leakage, correct it.
>> When recharging the refrigerant, make sure to perform vacuuming, and recharge the specified amount.
- ▶ Check EEV (Service Parts Information 12, 13,14)
- ▶ Check Solenoid Valve (Service Parts Information 15)
- ▶ Check Compressor (Service Parts Information 1)

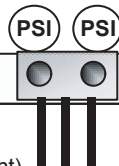

Attention!!

Strainer normally does not have temperature difference between inlet and outlet as shown in (1), but if there is a difference like shown in (2), there is a possibility of inside clogged. In this case, replace Strainer.

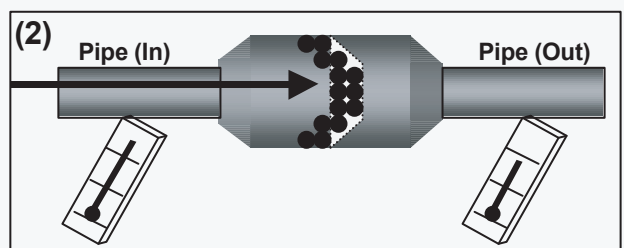
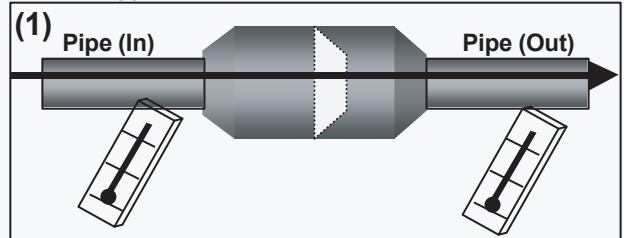

Trouble shooting 60

Abnormal Noise

Forecast of Cause :

1. Abnormal installation (Indoor/Outdoor)
2. Fan failure(Indoor/Outdoor)
3. EEV failure (Indoor)
4. Compressor failure (Outdoor)

Diagnosis method when Abnormal Noise is occurred

Abnormal noise is coming from Indoor Unit
(Check and correct followings)

- Is Main Unit installed in stable condition?
- Is the installation of Air suction grille and front panel normal?
- In case of Duct type : Is Static Pressure range normal?
(Refer to Data & Technical Manual)

OK

- Is Fan broken or deformed?
- Is the screw of Fan loose?
- Is there any object which obstruct the Fan rotation?

Attention!!

If Refrigerant Noise is occurring, Check if the Indoor and Outdoor Thermistor is wrongly installed. Check and correct the thermistor.

Abnormal noise is coming from Outdoor Unit
(Check and correct followings)

- Is Main Unit installed in stable condition?
- Is Bell Mouth installed normally?

OK

- Is Fan broken or deformed?
- Is the screw of Fan loose?
- Is there any object which obstruct the Fan rotation?

OK

- Check if vibration noise by loose bolt or contact noise of piping is happening.

OK

- Is Compressor locked?
>> Check Compressor (Service Parts Information 1)

Trouble shooting 61

Water Leaking

Forecast of Cause :

1. Erroneous installation
2. Drain hose failure
3. Float Switch failure

Diagnosis method when water leak occurs

- Is Main Unit installed in stable condition?
- Is Main Unit broken or deformed at the time of transportation or maintenance?

OK

- Is Drain Hose connection loose?
- Is there a trap in Drain Hose?
- Is Drain Hose clogged?

OK

- Is Fan rotating?
>> Check Fan Motor (Service Parts Information 17,19)

OK

- Is Float Switch defective?
>> Check Float Switch (Refer to Trouble Shooting 7)

Diagnosis method when water is spitting out

- Is the filter clogged?

OK

- Check Gas Pressure and correct it if there was a gas leak.

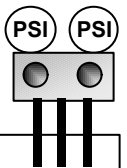

Attention!!

If water is leaking from the Indoor Unit that is not in operation, there is a possibility of Indoor EEV is not closed.

=> Check EEV (Service Parts Information 12)

4-3-3 Trouble Shooting for Optional Parts

1. External Switch Controller (UTY-TEKX)

Trouble shooting 62

Error Contents :
Power Supply Error

Symptom :
No operation & LED does not light up.

Condition :

1. No power supply.
Voltage error between red and black terminals of External Switch Controller. (Normal voltage: 12V plus minus 10%)
2. Electric circuit error.
Voltage is normal between red and black terminals of External Switch Controller (Normal voltage: 12V plus minus 10%)

Cause 1 : Indoor unit defective

- Refer to Indoor unit trouble shooting.



Cause 2 : Connection cable is defective or open.

- Check installation of connection cable.
- Check if connection cable is open.

OK

Cause 3 : Defective insertion or open connection of the cable between External Switch Controller terminal and PCB.

- Check connector insertion.
- Check if connection cable is open.

↓ OK

Cause 4 : Ext. Switch Controller is defective.

▶ **Replace External Switch Controller.**

Trouble shooting 63

Error Contents :
The abnormality in connection of remote controller cable

Symptom :
LED repeats flashing 0.5sec ON & 0.5sec OFF.

Condition :

Communication with Indoor unit has been cut off for longer than 1 minute.

Cause 1 :
Communication cable is defective or open.

- Check installation of connection cable.
- Check if connection cable is open.



Cause 2 : Defective insertion or open connection of the cable between External Switch Controller terminal and PCB.

- Check connector insertion.
- Check if connection cable is open.



Cause 3 : DIP switch setting defective

- Check setting of DIP-SW1-4, 1-5, 1-6.

OK

Cause 4 : External noise

- Remove or shut out external noise source.

↓ OK

Cause 5 : Ext. Switch Controller is defective.

▶ **Replace External Switch Controller.**

Trouble shooting 64

Error Contents :
Transmission Error

Symptom :
LED repeats flashing 0.5sec ON & 1.0sec OFF.

Condition :
Normal communication with Indoor unit has been suspended for longer than 1 minute.

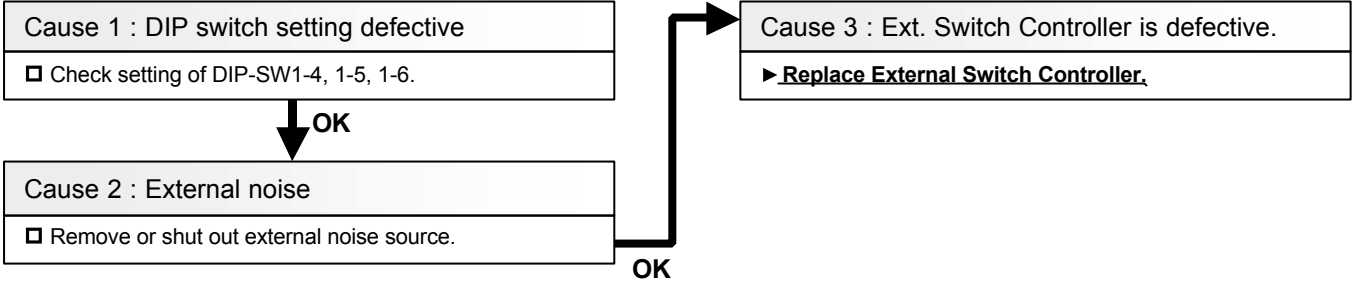

Trouble shooting 65

Error Contents :
Switch Operation Error

Symptom :
LED is lighting but Switch (SW1 or SW2) does not operate.

Condition :
Switch input can not be detected.

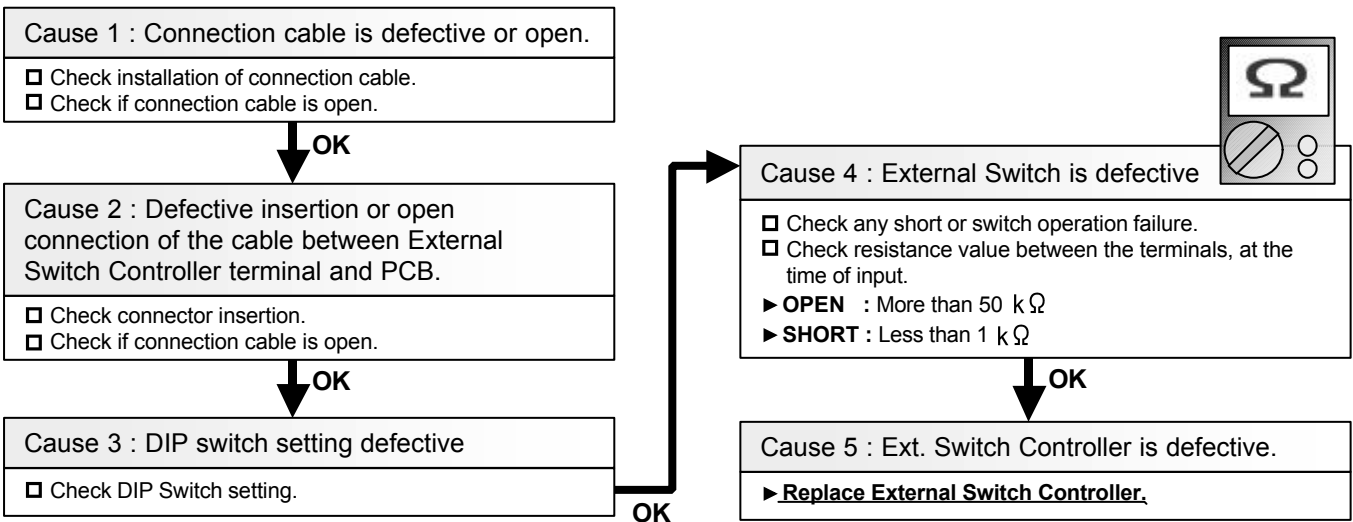

2. Signal Amplifier (UTY-VSGX)

Trouble shooting 66

Error Contents :
Power Supply Error

Symptom :
No display

Details :

Condition of occurrence : Normal power is not supplied. 7 segment indicator is defective.
Release condition : Normal power is supplied. 7 segment indicator is normal.

Cause 1 :
Power supply cable installation is defective or open.

- Check following installation and reset the power supply.
- (1) Installation of power cable on power supply terminal.
- (2) Connection between Power PCB and Terminal.
- (3) Connector condition between power PCB and Main PCB.

OK

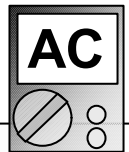

Cause 2 : Signal Amplifier is defective.

If normal voltage (208~230V) is applied to power supply terminal of Signal Amplifier, there is a possibility of defective PCB. Proceed as follows.
▶ **Replace Signal Amplifier.**

Trouble shooting 67

Error Contents :
Communication Error

Symptom :
Error code does not appear [_]
Communication error occurs at connected equipment side.

Details :

Condition of occurrence : Network cable defective. External noise is applied.
Overlapping of Signal Amplifier address setting. System design mistake.
Release condition : Network cable is connected. External noise is removed.
Overlapping of Signal Amplifier has been corrected. System design is normal.

Cause 1 :
Network cable installation is defective or open.

- Check Network cable installation.

OK

Cause 2 : External noise

- Remove external noise around Signal Amplifier or Network cable. (Keep enough distance)

OK

Cause 3 :
Overlapped address of Signal Amplifier.

- Set up address again which does not overlap on system. After set up again, reset the power supply.

OK

Cause 4 : System Design mistake

- Check following items.(Refer to Installation Manual)
- (1) Installation location of Terminal Resistor.
(Only 1 location on NS*)
- (2) Cable length. (Within 1640ft.(500m) maximum on NS*)
- (3) Number of units connected
(Up to 64 units maximum on NS*)
- (4) Communication cable specification.
(Use specified type.)
- (5) Number of Signal Amplifier installed.
(Up to 8 units max. on system)
- (6) Network cable shall not be connected in loop.

*NS : Network Segment

Trouble shooting 68

Error Contents :
Address Setting Error

Symptom :
Error display [2 6]
No operation.

Details :

Condition of occurrence : Address is not set at Signal Amplifier.

Release condition : Address setting mode is started up, and desired address has been set up.

Cause 1 : External noise

- Upon pressing RESET button (SW7) or turning on power, proceed as follows.
- (1) If error did not appear, it is not a defect of PCB. Remove the surrounding noise source.
- (2) If error occurs again, check followings other than removing surrounding noise source.

OK

Cause 2 : Address is not set at Signal Amplifier.

- Set up address again.
After set up again, reset the power supply.

OK

Cause 3 : Signal Amplifier is defective.

- ▶ **Replace Signal Amplifier.**

Trouble shooting 69

Error Contents :
Parallel Communication

Symptom :
Error display [C 1]
No operation.

Details :

Condition of occurrence : Communication error between CPU and Network Driver IC

Release condition : Communication is normal between CPU and Network Driver IC

Cause 1 : External noise

- Upon pressing RESET button (SW7) or turning on power, proceed as follows.
- (1) If error did not appear, it is not a defect of PCB. Remove the surrounding noise source.
- (2) If error occurs again, check followings other than removing surrounding noise source.

OK

Cause 2 : Signal Amplifier is defective.

- ▶ **Replace Signal Amplifier.**

Trouble shooting 70

Error Contents :
Communication Error B

Symptom :
Error display [D9 (Flashing or Lighting)]
No operation.

Details :

Condition of occurrence : Communication error between CPU and Network Driver IC (CH_B side).

Network Driver IC is defective.

Release condition : Communication is normal between CPU and Network Driver IC (CH_B side).

Network Driver IC operation is normal.

Cause 1 : External noise

- Upon pressing RESET button (SW7) or turning on power, proceed as follows.
- (1) If error did not appear, it is not a defect of PCB. Remove the surrounding noise source.
- (2) If error occurs again, check followings other than removing surrounding noise source.

OK

Cause 2 :Signal Amplifier is defective.

► **Replace Signal Amplifier.**

Trouble shooting 71

Error Contents :
Communication Error A

Symptom :
Error display [D14 (Flashing or Lighting)]
No operation.

Details :

Condition of occurrence : Communication error between CPU and Network Driver IC (CH_A side).

Network Driver IC is defective.

Release condition : Communication is normal between CPU and Network Driver IC (CH_A side).

Network Driver IC operation is normal.

Cause 1 : External noise

- Upon pressing RESET button (SW7) or turning on power, proceed as follows.
- (1) If error did not appear, it is not a defect of PCB. Remove the surrounding noise source.
- (2) If error occurs again, check followings other than removing surrounding noise source.

OK

Cause 2 : Signal Amplifier is defective.

► **Replace Signal Amplifier.**

3. Network Convertor (UTY-VGGX)

2. When connecting a single split type indoor unit to a network convertor

Trouble shooting 72

Error Contents :
Power Supply Error

Symptom :
No display

Details :

Condition of occurrence : Normal power is not supplied. 7 segment indicator is defective.
Release condition : Normal power is supplied. 7 segment indicator is normal.

Cause 1 :
Power supply cable installation is defective or open.

- Check following installation and reset the power supply.
 - (1) Installation of power cable on power supply terminal.
 - (2) Connection between Power PCB and Terminal.
 - (3) Connector condition between power PCB and Main PCB.

OK

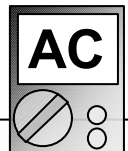

Cause 2 : Network Convertor is defective.

If normal voltage (208~230V) is applied to power supply terminal of Network Convertor, there is a possibility of defective PCB. Proceed as follows.

▶ **Replace Network Convertor.**

Trouble shooting 73

Error Contents :
PCB Error 1

Symptom :
Error Code display [C 1]
All the control items do not operate.

Details :

Condition of occurrence : Synchronization of Network Device was not normally done.
Release condition : When the synchronization of the device is normally done.

Cause 1 : External noise

- After pressing SW104 of Network Convertor PCB for 5 seconds or turning on power.
Does error code display reappear?

YES

- Remove the surrounding noise source.

NO

- It is not a defect of PCB. Remove the surrounding noise source.

OK

Cause 2 : Network Convertor is defective.

▶ **Replace Network Convertor.**

Trouble shooting 74

Error Contents :

Communication Error with Standard Remote Controller

Symptom :

Error Code display [1 2] Control/Display from Standard Remote s not available. Other controls are left as they are.

Details :

Condition of occurrence : The communication between Standard Remote Controller and Network Converter was not normally performed.

Release condition : When the communication between Standard Remote Controller and Network Converter resumes normal operation.

Cause 1 : External noise

- After pressing SW104 of Network Converter PCB for 5 seconds or turning on power. Does error code display reappear?

↓ YES

- Remove the surrounding noise source.

↓ OK

↓ NO

- It is not a defect of PCB. Remove the surrounding noise source.

Cause 2 :

Defective or open connection of cable wire between Network Converter and Connected Remote Controller.

After the following are checked, the power supply is reset.

- Check connection cable wire between Network Converter and Connected Remote Controller.
- Check connection between Control PCB and Terminal.

↓ OK

Cause 3 : Incorrect setting of Network Converter's DIP-SW107[2] (Wired RC Validity setting)

- Check Network Converter PCB DIP-SW107[2].

↓ OK

Cause 4 : Incorrect selection of Remote Controller

- Check connection Remote Controller. (Is it specified with the Installation Manual of Network Converter?)

↓ OK

Cause 5 :

Incorrect setting of Remote Controller's DIP-SW (Number of connected remote controllers)

- Check DIP-SW of Remote Controller.

↓ OK

Cause 6 : Defective Remote Controller or Network Converter.

- ▶ **Replace Remote Controller or Network Converter.**

Trouble shooting 75

Error Contents :
**Communication Error
with Indoor Unit**

Symptom :
**Error Code display [1 6]
All the control items do not operate.**

Details :

Condition of occurrence : The communication between Indoor unit and Network Converter was not performed normally.

Release condition : When the communication with Indoor unit is resumed normally.

Cause 1 : External noise

- After pressing SW104 of Network Converter PCB for 5 seconds or turning on power.
Does error code display reappear?

↓ YES

↓ NO

- Remove the surrounding noise source.

- It is not a defect of PCB. Remove the surrounding noise source.

↓ OK

Cause 2 :

Defective or open connection of Remote Control cable between Network Converter and Indoor Unit.

After the following are checked, the power supply is reset.

- Check connection cable wire between Network Converter and Indoor unit.
 Check connection between Control PCB and Terminal.

↓ OK

Cause 3 : Power to Indoor unit is shut down.

- Check the power to Indoor unit.

↓ OK

Cause 4 : Incorrect setting of main unit address of Indoor unit.

- Check main unit address setting of Indoor unit.

↓ OK

Cause 5 : Incorrect setting of DIP-SW of Network Converter. Mis-read of Indoor unit type and RC type.

- Check DIP-SW103[1 to 8] of Network Converter (Indoor unit type, RC type, number of Indoor units connected.)
 Check Indoor unit type and RC type of all Indoor units connected to Network Converter.

↓ OK

Cause 6 : Defective PCB of Indoor unit or Network Converter.

- ▶ **Replace PCB of Controller PCB or Network Converter.**
>>If replace Controller PCB, Refer to 06-03 page Main PCB removal.

Trouble shooting 76

Error Contents :
Communication Error with Indoor Unit

Symptom :
Error Code display [2 6]
All the control items do not operate.

Details :

Condition of occurrence : The communication between Indoor unit and Network Converter was not performed normally.
Release condition : When the communication with Indoor unit is resumed normally.

Cause 1 : External noise

- After pressing SW104 of Network Converter PCB for 5 seconds or turning on power.
Does error code display reappear?

↓ YES

- Remove the surrounding noise source.

↓ OK

↓ NO

- It is not a defect of PCB. Remove the surrounding noise source.

Cause 2 : Defective or open connection of Remote Control cable between Network Converter and Indoor Unit.

- After the following are checked, the power supply is reset.
- Check connection cable wire between Network Converter and Indoor unit.
 - Check connection between Control PCB and Terminal.

↓ OK

Cause 3 : Power to Indoor unit is shut down.

- Check the power to Indoor unit.

↓ OK

Cause 4 : Incorrect setting of main unit address of Indoor unit.

- Check main unit address setting of Indoor unit.

↓ OK

Cause 5 : Incorrect setting of DIP-SW of Network Converter. Mis-read of Indoor unit type and RC type.

- Check DIP-SW103[1 to 8] of Network Converter (Indoor unit type, RC type, number of Indoor units connected.)
- Check Indoor unit type and RC type of all Indoor units connected to Network Converter.

↓ OK

Cause 6 : Defective PCB of Indoor unit or Network Converter.

- ▶ **Replace PCB of Controller PCB or Network Converter.**
>>If replace Controller PCB, Refer to 06-03 page Main PCB removal.

Trouble shooting 77

Error Contents :
Software Error

Symptom :
Error Code display [C A]
All the control items do not operate.
Other Controls are left they are.

Details :

Condition of occurrence : Micon program performed an abnormal control.
Error of inside information of EEPROM.
initial setting of Network Converter PCB was not normally performed.

Release condition : Micon has been reset, and the control of Network Converter became normal.
When error disappeared and Network Converter becomes available to control.

Cause 1 : External noise

- Check continuation of error.
(1) If error is released automatically, it is not a defect of PCB. Remove the surrounding noise source around Network Converter.
(2) If error is not released automatically, check followings.

↓
OK

- After pressing SW104 of Network Converter PCB for 5 seconds or turning on power.
Does error code display reappear?

↓
YES

- Remove the surrounding noise source.

↓
OK

↓
NO

- It is not a defect of PCB. Remove the surrounding noise source.

Cause 2 : Network Converter is defective.

- ▶ **Replace Network Converter.**

Trouble shooting 78

Error Contents :
Indoor / Outdoor Unit Error

Symptom :
Error Code display [5 U]
Other controls are left as they are.

Details :

Condition of occurrence : When error occurred on Indoor/Outdoor unit that is connected to Network Converter.
Release condition : When the error of Indoor/Outdoor unit that is connected to Network Converter is released.

Cause 1 : Error occurred in Indoor unit

- ▶ **Refer to Indoor Unit trouble shooting.**
(Removal of error of indoor unit connected to network converter)

↓
OK

Cause 2 : Error occurred in Outdoor unit

- ▶ **Refer to Outdoor Unit trouble shooting.**
(Removal of error of outdoor unit connected to network converter)

4. Wired Remote Controller (UTY-RNK*)

Trouble shooting 79

Error Contents :
Thermo Sensor Error

Symptom :

Thermostat Sensor display is flashing.

Details :

Condition of occurrence : Thermistor in remote controller is open or shorted.

Release condition : Thermistor in remote controller is not open or shorted.

Cause 1 : Remote controller internal thermistor trouble

- Replace remote controller.

5. Wired(UTY-RNK*) and Simple Remote Controller (UTY-RSK*,RHK*)

Trouble shooting 80

Error Contents :
Indoor Unit ↔ Remote Controller
Communication Error

Symptom :
Error Code display [1 2]

Details :

Condition of occurrence : When signal from indoor unit does not enter
Release condition : When signal from indoor unit entered

Cause 1 : Check connection

- Check cable
- Check indoor unit power supply



Cause 2 : Check indoor unit remote controller address.

- Check if the indoor unit remote controller addresses are sequentially set from 0.



Cause 3 : Noise

- Remove the surrounding noise.



Cause 4 : Remote controller trouble

- Replace remote controller.



Cause 5 : Indoor unit PCB trouble

- Change Controller PCB and set up the original address.
(Refer to 06-03 page Main PCB removal.)

Trouble shooting 81

Error Contents :
Incompatible Indoor Unit is Connected

Symptom :
Error Code display [1 5]

Details :

Condition of occurrence : When information was not obtained from indoor unit
Release condition : When information was obtained from indoor unit

Cause 1 : Check remote controller master/slave setting.

- For the check and modification methods, refer to the remote controller (including external SW) installation manual.
- When there is 1 remote controller, check whether or not it is set as the master remote controller.
- When there are 2 remote controllers, check if one side is the master remote controller and the other side is the slave remote controller.
- When there are 1 remote controller and 1 external switch controller, check if the remote controller is master controller and the external switch controller is slave controller.



Cause 2 : Check connection

- Check cable
- Check indoor unit power supply



Cause 3 : Noise

- Source around cable



Cause 4 : Remote controller trouble

- Replace remote controller.



Cause 5 : Indoor unit PCB trouble

- Change Controller PCB and set up the original address.
(Refer to 06-03 page Main PCB removal.)

6. System Controller (UTY-APGX) / Service Tool (UTY-ASGX) / Web Monitoring Tool (UTY-AMGX)
(Referred to as "Service Tool" hereafter)

Trouble shooting 82

Error Contents :
Unit Not Detected

Symptom :

1 or more units (but not all) are not detected after Scan.
1 or more units (but not all) are not listed in the system list after Scan.

Details :

Condition of occurrence:

- Unit address is not set correctly.
- Network cable is not connected correctly.
- System design is mistaken.
- Unit transmission board is defective.

Recovery condition:

- Unit address is set correctly.
- Network cable is connected as designed.
- System design and work is corrected.
- Unit transmission board is normal.

Cause 1 : Unit address is not set correctly.

- Check the unit address setting of the undetected unit and correct it if mistaken.



Cause 2 : Network cable is not connected as designed.

- Check that the network cables are connected according to the site design drawing.
Check specifically the network segment where the undetected unit exists.
- Check and fix the loose cable connection to the terminal of the undetected unit.
- Using Service Tool, perform scan changing the network segment where the Service Tool is connected and localize the mistaken network segment. Start from the network segment where the undetected unit exists.
Specify priority scan when possible.



Cause 3 : System design work is mistaken.

- Check the following items and fix appropriately if mistaken.
 - (1) 1 (and only 1) Terminal Resistor is connected for each network segment.
 - (2) Cable length is within 1640ft. (500m) for each network segment.
 - (3) Number of units connected within a network segment does not exceed 64.
(1 connected port of Signal Amplifier is counted as 1).
 - (4) Network cable specification is as specified in the Design & Technical Document.
 - (5) Total number of Signal Amplifiers does not exceed 8 per system.
 - (6) Network cable is not connected in loop.
 - (7) Both ends of the network cable are grounded.
 - (8) Network cables are not bundled together with power cables to prevent noise induction.



Cause 4 : Unit transmission board is defective.

- Replace transmission board of the undetected unit if none of the above cause applies.

Note :

A Network Segment is a portion of the network connected directly by network cables and is separated by Signal Amplifiers. If no Signal Amplifier exists, there is only 1 network segment.

Trouble shooting 83 INDOOR UNIT Error Method: Indoor Unit power supply error for FAN motor 1 (2)	E39. 1 (E39. 2)	Indicate or Display: Outdoor Unit : E.5 U.1 Error Code : 3 9 , 3 9 . 1 (2)
---	----------------------------------	---

Detective Actuators: Indoor Unit Controller PCB Circuit Indoor Unit Power supply PCB Circuit	Detective details: When the DC power input for Fan motor < W500 - W501 (W530 - W531) on the Power supply PCB > becomes lower voltage than the specified voltage.
---	--

Forecast of Cause : 1. Noise momentary open, voltage drop 2. Wire connection 3. Fan motor 4. Peripheral electric devices 5. Power supply PCB 6. Controller PCB
--

Check Point 1 : Check if any outside cause such as voltage drop or noise
<ul style="list-style-type: none"> ● Instant voltage drop ----- Check if there is any electric equipment with a large load within the same circuit. ● Momentary power failure ----- Check contact failure or leak current in power supply circuit ● Check if there is any equipment that causes harmonic wave near the power cable (Neon light bulb or any electronic equipment which causes harmonic wave). And check the complete insulation of grounding. <p>>>If the same symptom does not reappear after resetting the power, possibility of noise is high.</p>



Check Point 2 : Check wire connection
<input type="checkbox"/> Wire lose connection / damage between the CN21 on the Controller PCB and CN250 on the Power supply PCB. In case of Model 72, between W530 (W531) on the Power supply PCB and Capacitor. >>If there is abnormal on the wire, replace it



Check Point 3 : Check rotation of Fan / wire resistance
<input type="checkbox"/> Rotate the applicable fan by hand when operation is off. <input type="checkbox"/> Disconnect the connector from the Power supply PCB and Check resistance value of Motor connector. (Refer to the service parts information 21)



Check Point 4 : Check peripheral devices, Posistor, Capacitor, Diode bridge
<input type="checkbox"/> Check resistance value, short circuit, visible damage >>If there is abnormal , replace it



Check Point 5 : Replace Power supply PCB
<input type="checkbox"/> Change Power supply PCB



Check Point 6 : Replace Controller PCB
<input type="checkbox"/> Change Controller PCB and set up the original address.

Trouble shooting 84 INDOOR UNIT Error Method: Indoor unit suction air temp. thermistor error	E 4A.1	Indicate or Display: Outdoor Unit : E.5 U.1 Error Code : 4 A, 4 A. 1
--	---------------	---

Detective Actuators: Indoor Unit Controller PCB Circuit Suction air temp. thermistor	Detective details: When Indoor unit suction air temp. thermistor open or shortage is detected
---	---

Forecast of Cause : 1. Connector defective connection 2. Thermistor defective 3. Controller PCB defective

Check Point 1 : Check connection of Connector
<input type="checkbox"/> Check if connector is loose or removed <input type="checkbox"/> Check erroneous connection <input type="checkbox"/> Check if thermistor cable is open >>Reset Power when reinstalling due to removed connector or incorrect wiring.



Check Point 2 : Remove connector and check sensor resistance value									
Sensor Characteristics (Rough value)									
Temperature (°F)	32	41	50	59	68	77	86	95	
Temperature (°C)	0	5	10	15	20	25	30	35	
Resistance Value (kΩ)	33.6	25.2	20.1	15.8	12.5	10.0	8.0	6.5	
Temperature (°F)	104	113	122						
Temperature (°C)	40	45	50						
Resistance Value (kΩ)	5.3	4.3	3.5						
► If Thermistor is either open or shorted, replace it and reset the power.									

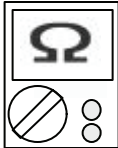

Check Point 3 : Check voltage CN9 of Controller PCB (DC5.0V)
► If the voltage does not appear, replace Controller PCB and set up the original address.



Trouble shooting 85 INDOOR UNIT Error Method: E 4A.2 Indoor unit discharge air temp. thermistor error	Indicate or Display: Outdoor Unit : E.5 U.1 Error Code : 4 A, 4 A. 2
---	---

Detective Actuators: Indoor Unit Controller PCB Circuit Discharge air temp. thermistor	Detective details: When Indoor unit discharge air temp. thermistor open or shortage is detected
---	---

Forecast of Cause : 1. Connector defective connection 2. thermistor defective 3. Controller PCB defective

Check Point 1 : Check connection of Connector
<input type="checkbox"/> Check if connector is loose or removed <input type="checkbox"/> Check erroneous connection <input type="checkbox"/> Check if thermistor cable is open >>Reset Power when reinstalling due to removed connector or incorrect wiring.



Check Point 2 : Remove connector and check sensor resistance value									
Sensor Characteristics (Rough value)									
Temperature (°F)	32	41	50	59	68	77	86	95	
Temperature (°C)	0	5	10	15	20	25	30	35	
Resistance Value (kΩ)	33.6	25.2	20.1	15.8	12.5	10.0	8.0	6.5	
Temperature (°F)	104	113	122						
Temperature (°C)	40	45	50						
Resistance Value (kΩ)	5.3	4.3	3.5						
▶ If Thermistor is either open or shorted, replace it and reset the power.									



Check Point 3 : Check voltage CN9 of Controller PCB (DC5.0V)
▶ If the voltage does not appear, replace Controller PCB and set up the original address.



Trouble shooting 86 E59. 2 INDOOR UNIT Error Method: Indoor Unit Fan Motor 2 rotation speed Error	Indicate or Display: Outdoor Unit : E.5 U.1 Error Code : 59, 59.2
---	--

Detective Actuators: Indoor Unit Controller PCB Circuit Indoor Fan Motor 2	Detective details: When the FAN motor feed back rotation value which is detecting on the controller PCB becomes 0 and lasts for more than 1 minute at motor operation condition. Or, when the feed back rotation value continues at 1/3 of target value for more than 1 minute.
---	--

Forecast of Cause : 1. Fan rotation failure 2. Fan motor winding open 3. Motor protection by ambient temp. increase
4. Capacitor failure 5. Controller PCB failure

Check Point 1 : Check rotation of Fan

Rotate the fan by hand when operation is off.
(Check if fan is caught, dropped off or locked motor)
>>If Fan or Bearing is abnormal, replace it.



Check Point 2 : Check Motor winding / Internal PCB circuit

Check Indoor Fan motor (Refer to the PARTS INFORMATION 21)
>>If Fan motor is abnormal, replace it.



Check Point 3 : Check ambient temp. around motor

Check excessively high temperature around the motor.
(If there is any surrounding equipment that causes heat)
>>Upon the temperature coming down, restart operation..



Check Point 4 : Check Motor Capacitor

Check continuity of motor capacitor
>>If it is shorted, replace the capacitor.



Check Point 5 : Replace Controller PCB

Change Controller PCB and set up the original address.

Trouble shooting 87

Outdoor air unit - No Power

Forecast of Cause :

1. Power Supply failure
2. Outside cause
3. Electrical Component defective

Check Point 1 : Power supply

- ❑ Is not the breaker down?
 - Instant drop ----- Check if there is a large load electric apparatus in the same circuit.
 - Momentary power failure ----- Check if there is a defective contact or leak current in the power supply circuit.
 - Noise ----- Check if there is any equipment causing harmonic wave near electric line (Neon bulb or electric equipment that may cause harmonic wave).
Check the complete insulation of grounding.

↓ **OK**

Check Point 2 : Check Protector (20A)

- ❑ Check protector open / short
If the protector is open circuit, replace it.

↓ **OK (No short circuit)**

Check Point 3 : Check AC line

- ❑ Check AC line (L-N) open / short

↓ **NG (Short circuit)**

Check Point 4 : Check short circuit Filter PCB

- ❑ Disconnect the wire between Filter PCB and reactor, check short circuit of AC line.
If there is short circuit, replace the Filter PCB.

↓ **OK (No short circuit)**

Check Point 5 : Check short circuit Diode bridge

- ❑ Connect the disconnected wire(s) on the check point 4, disconnect the wire between Diode bridge and Capacitor, check short circuit of AC line.
If there is short circuit, replace the Diode bridge.

↓ **OK (No short circuit)**

Check Point 6 : Check short circuit Capacitor

- ❑ Connect the disconnected wire(s) on the check point 5, disconnect the wire between Capacitor and Filter PCB, check short circuit of AC line.
If there is short circuit, replace the Capacitor.

↓ **OK (No short circuit)**

Check Point 7 : Check short circuit Power supply PCB

- ❑ Connect the disconnected wire(s) on the check point 6, disconnect the wire of Fan motor, check short circuit of AC line.
If there is short circuit, replace the Power supply PCB.

↓ **OK (No short circuit)**

Check Point 8 : Check Fan Motor

- ❑ Check open / short of FAN motor
Refer to the Service Parts Information 21
If there is short circuit, replace FAN motor.

↓ **OK (No short circuit)**

Check Point 9 : Short circuit check on DC circuit

Disconnect the connector (CN200) on the Power supply PCB and check the short circuit

1. DC12V line (CN200 Pin 1 - 5)
2. DC 5V Line (CN200 Pin 1 - 3)
3. DC 15V-1 Line (CN500 Pin 3 - 4)
4. DC 15V-2 Line (CN530 Pin 3 - 4)

If one of them is short circuit, replace the Power supply PCB

↓ **OK (No short circuit)**

Check Point 10 : Check short circuit of actuators (for DC12V)

- ❑ Disconnect the CN10 (EEV1) on the Main PCB, and check short circuit on Main PCB CN 4 Pin 1 - 5.
If the short circuit disappears, replace the EEV coil.
- ❑ Disconnect the CNC01 (WRC) on the Main PCB, and check short circuit on Main PCB CN 4 Pin 1 - 5.
If the short circuit disappears, check the WRC wire, WRC.
- ❑ Disconnect the CNB01 (Ext.Out) on the Main PCB, and check short circuit on Main PCB CN 4 Pin 1 - 5.
If the short circuit disappears, check the Ext. device or wiring.
- ❑ Disconnect the CN2 (TransmissionPCB) on the Main PCB, and check short circuit on Main PCB CN 4 Pin 1 - 5.
If the short circuit disappears, replace the Transmission PCB.
- ❑ Disconnect the CN22 (Interconnecting wire) on the Main PCB, and check short circuit on Main PCB CN 4 Pin 1 - 5.
If the short circuit disappears, replace the Filter PCB.
- ❑ If the short circuit appears after disconnecting actuators, replace the Main PCB.

↓ **OK (No short circuit)**

Check Point 11 : Check short circuit of actuators (for DC5V)

- ❑ Disconnect the CN14 (SW PCB) on the Main PCB, and check short circuit on Main PCB CN 4 Pin 1 - 3.
If the short circuit disappears, replace the SW PCB.
- ❑ Disconnect the CN18 (Receiver unit *Option) on the Main PCB, and check short circuit on Main PCB CN 4 Pin 1 - 3.
If the short circuit disappears, check the wire, Receiver unit.
- ❑ Disconnect the CN2 (Transmission PCB) on the Main PCB, and check short circuit on Main PCB CN 4 Pin 1 - 3.
If the short circuit disappears, replace the Transmission PCB.
- ❑ Disconnect the CN21 (Interconnecting wire) on the Main PCB, and check short circuit on Main PCB CN 4 Pin 1 - 3.
If the short circuit disappears, replace the Power supply PCB.
- ❑ If the short circuit appears after disconnecting actuators, replace the Main PCB.

Trouble shooting 88 E39. 3 <u>INDOOR UNIT Error Method:</u> Indoor Unit Power Supply Error of AC24V System	<u>Indicate or Display:</u> Outdoor Unit : E.5 U.1 Error Code : 3 9
--	--

<u>Detective Actuators:</u> Indoor Unit Power Supply PCB Circuit Indoor Unit Power Trans Indoor Unit Controller PCB	<u>Detective details:</u> When the AC voltage of the Power Trans output , Is lower than 24V.
---	--

<u>Forecast of Cause :</u> 1. Terminal Connection Abnormal 2. Power Supply Abnormal 3. Power Trans 4. Power Supply PCB 5. Controller PCB 6. Cable Connection failure
--

Check Point 1 : Check the Power Supply PCB and Controller PCB
<input type="checkbox"/> Check the connection of connection terminal between Power Supply PCB(CN24) and Controller PCB(CN114) and check if there is a disconnection or short of the cable.



Check Point 2 : Check the connection of terminal
<input type="checkbox"/> After turning off the power, check & correct of followings. >>Check the connection of terminal between Power Trans and Power Supply PCB(CN113), and Check if there is a disconnection or short of the cable.



Check Point 3 : Check the Power Trans and Power Supply PCB
<input type="checkbox"/> Check terminal voltage of Power Trans and Power Supply PCB connector CN113 (AC24V IN). If AC 0V, Power Trans is failure >> <u>Replace Power Trans</u> . If AC24V, To the Check Point 4.

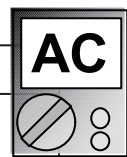

Check Point 4 : Replace the Power Supply PCB
▶ Replace Power Supply PCB.



Check Point 5 : Replace the Controller PCB
▶ Replace Controller PCB and set up the original address.

Trouble shooting 89 E26. 4 INDOOR UNIT Error Method: Address Duplication in Wired remote controller system	Indicate or Display: Outdoor Unit : E.5 U.1 Indoor Unit : Operation LED 2 times Flash, Timer LED 6 Times Flash, Filter LED Continuous Flash. Error Code : 2 6
--	--

Detective Actuators: Wired remote controller (2-Wire) Indoor unit Controller PCB circuit	Detective details: When the duplicated address number exists in one RCgroup
---	---

Forecast of Cause : 1. Wrong wiring of RCgroup 2. Wrong remote address setting 3. Indoor unit controller PCB failure
4. Remote controller failure

Check Point 1 : Wire installation

- Wrong wire connection in RCgroup (Please refer to the installation manual)



Check Point 2 : Wrong RCgroup setting

- The duplicated address number is not existing in one RCgroup



Check Point 3 : Check Indoor unit controller PCB

- Check if controller PCB damage
- Change controller PCB and check the Error after setting remote controller address

Trouble shooting 90 E26. 5 INDOOR UNIT Error Method: Address setting Error in Wired remote controller system	Indicate or Display: Outdoor Unit : E.5 U.1 Indoor Unit : Operation LED 2 times Flash, Timer LED 6 Times Flash, Filter LED Continuous Flash. Error Code : 2 6
--	--

Detective Actuators: Wired remote controller (2-Wire) Indoor unit Controller PCB circuit	Detective details: When the address number set by auto setting and manual setting are mixed in one RC group
---	---

Forecast of Cause : 1. Wrong wiring of RCgroup 2. Wrong remote address setting 3. Indoor unit controller PCB failure
4. Remote controller failure

Check Point 1 : Wire installation

Wrong wire connection in RCgroup (Please refer to the installation manual)



Check Point 2 : Wrong RCgroup setting

The given address number by auto setting (00) and the manual set number (Except 00) were not existing in one RCG.
 The remote controller address setting by U.I. were not existing same address.



Check Point 3 : Check Indoor unit controller PCB

Check if controller PCB damage
 Change controller PCB and check the Error after setting remote controller address

Trouble shooting 91 E29. 1 INDOOR UNIT Error Method: Connection unit number error (Indoor unit in Wired remote controller system)	Indicate or Display: Outdoor Unit : E.5 U.1 Indoor Unit : Operation LED 2 times Flash, Timer LED 9 Times Flash, Filter LED Continuous Flash. Error Code : 2 9
---	--

Detective Actuators: Wired remote controller (2-Wire) Indoor unit Controller PCB circuit	Detective details: When the number of connecting indoor units are out of specified rule.
---	--

Forecast of Cause : 1. Wrong wiring/ Number of I.U, RC in RCgroup 2. Indoor unit controller PCB defective
--

Check Point 1 : Wire installation
<input type="checkbox"/> Wrong number of connecting indoor unit



Check Point 2 : Check Indoor unit controller PCB
<input type="checkbox"/> Check if controller PCB damage <input type="checkbox"/> Change controller PCB and check the Error after setting remote controller address

Trouble shooting 92 INDOOR UNIT Error Method: Connection unit number error (Remote controller)	E29. 2 Indicate or Display: Outdoor Unit : No Display Indoor Unit : No Display Error Code : 2 9
---	--

Detective Actuators: Wired remote controller (2-Wire)	Detective details: When the number of connecting remote controller are out of specified rule.
---	---

Forecast of Cause : 1. Wrong wiring / Wrong number of connecting RC in RCgroup 2. Remote controller PCB defective
--

Check Point 1 : Wire installation
<input type="checkbox"/> Wrong number of connecting remote controller



Check Point 2 : Check Indoor unit controller PCB
<input type="checkbox"/> Check if controller PCB damage <input type="checkbox"/> Change controller PCB and check the Error after setting remote controller address

Trouble shooting 94 E52. 1 INDOOR UNIT Error Method: Coil 1 (Expansion valve) Error	Indicate or Display: Outdoor Unit : E.5U.1 Indoor Unit : Operation LED 5 times Flash, Timer LED 2 Times Flash, Filter LED Continuous Flash. Error Code : 5 2
--	---

Detective Actuators: Indoor unit controller PCB	Detective details: When the EEV1 drive circuit is open circuit
---	--

Forecast of Cause :	1. EEV1 coil lose connection 2. EEV1 wire(s) cut or pinched 3. Defective EEV1 coil 4. Controller PCB (DC 12V) output abnormal 5. Noise momentary open, voltage drop
----------------------------	---

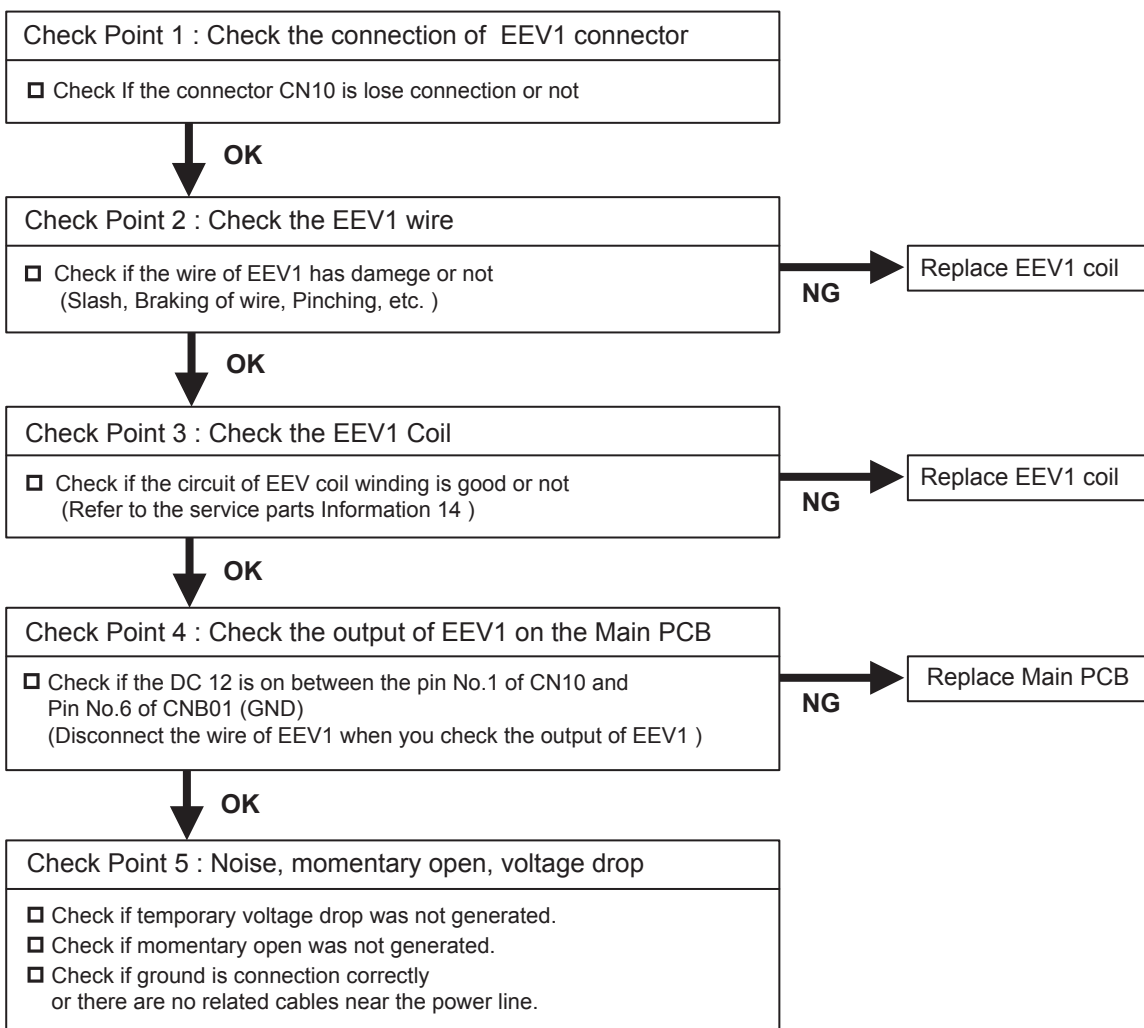

4-4 SERVICE INFORMATION

SERVICE INFORMATION

Backup Operation

Details :

- Backup operation is the operating method of replacing compressor while the system is running. Compressor can be replaced without stopping the system.
- In backup operation, cooling and heating capacity is decreased by the capacity of the separated outdoor unit.
- The work procedure is as follows.

4-4-1 Backup operation

1. Method of backup operation

1-1. Backup operation when compressor of the master unit is defective.

[Procedure]

(Example: Three outdoor units are connected.)

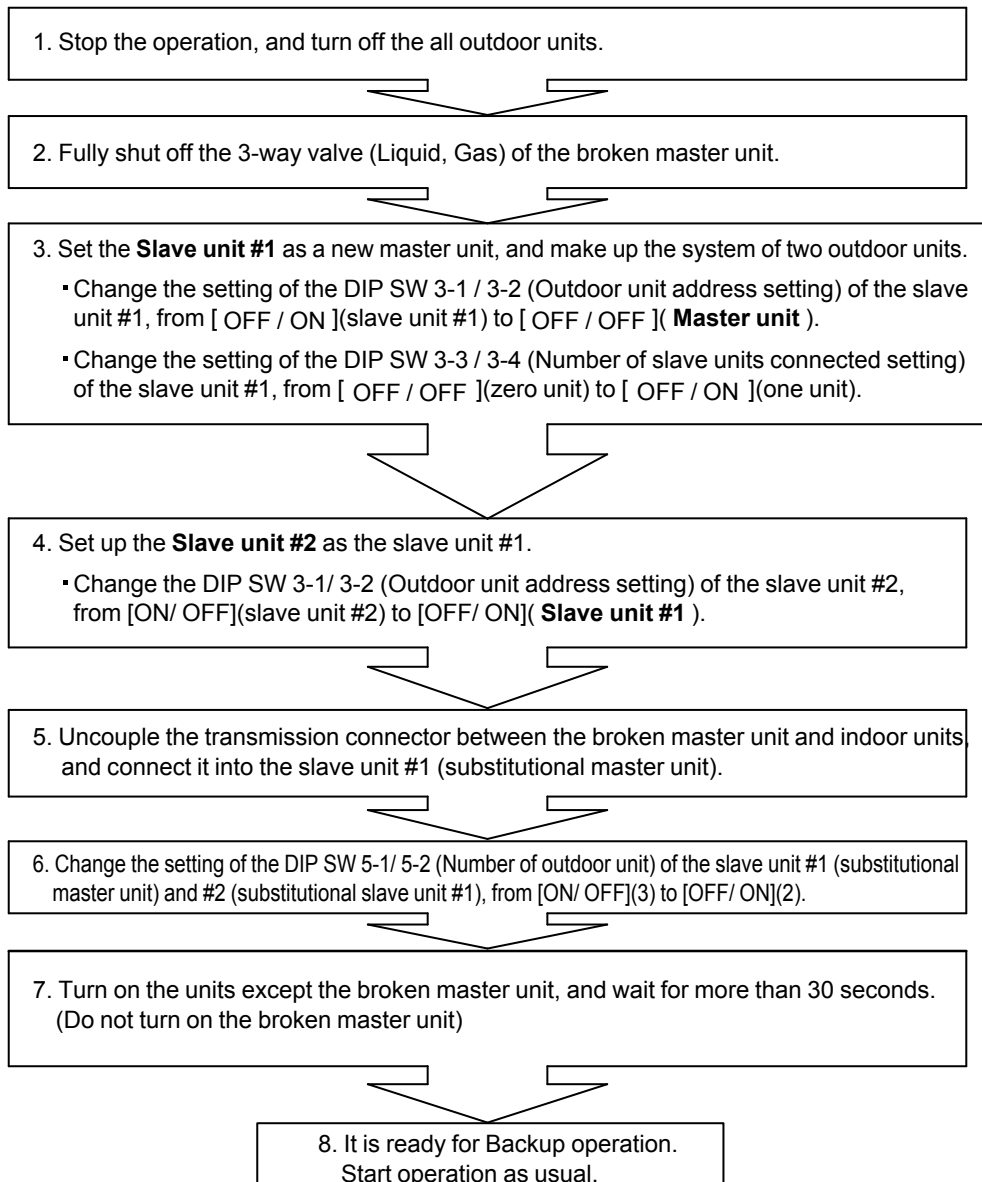

1-2. Backup operation when compressor of the slave unit #1 is broken.

[Procedure]

(Example: Three outdoor units are connected. the slave unit #1 is broken.)

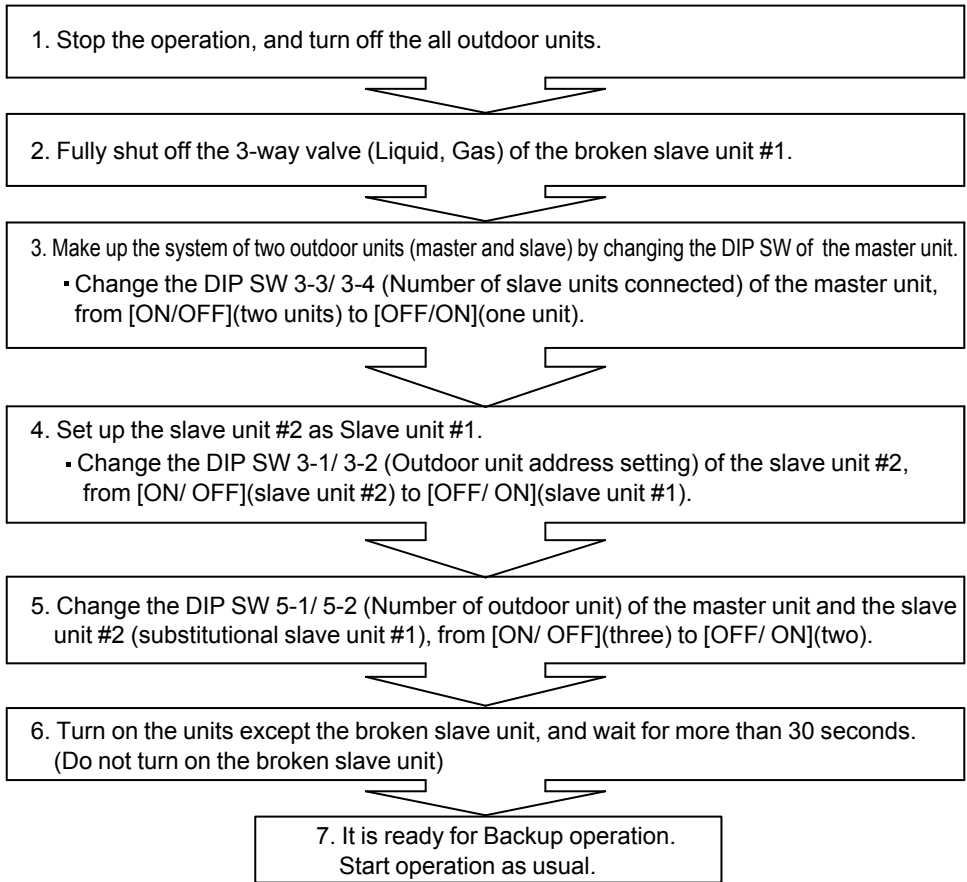

4-4-2 Work procedure after the backup operation

1. Refrigerant shortage at the backup operation

When excessive refrigerant accumulates in the defective outdoor unit during the backup operation, it becomes capacity shortage by refrigerant shortage.

The meaning of the sign

- LPS : Low pressure sensor detection value
- EEV1 : Expansion valve #1
- TH3 : Outdoor thermistor detection value
- TH4 : Suction thermistor detection value
- TH5 : Outdoor heat EX. temperature sensor detection value

<How to judge, when refrigerant is deficient>

Refrigerant shortage is judged by the information from "Service tool" during backup operation.

1. On Cooling operation

- ① It often creates "Low pressure protection stop" at start up or after oil recovery operation.
>>> When LPS < 15psi (0.1MPa) at start up, the compressor stops.
- ② Running indoor unit's EEV is fully open condition.
>>> It displays corresponding indoor unit's EEV on the chart at the bottom of the monitor.
If there is no sign of closing the EEV from fully opened condition.

2. On Heating operation

- ① It often creates "Low pressure protection stop" at start up or after oil recovery operation.
>>> When LPS < 15psi (0.1MPa) at start up, the compressor stops.
- ② EEV1 of outdoor unit is open at 500 pulse. (full admission).
- ③ Suction superheat is too high.
>>> When both TH5 < TH4 and TH4 \cong TH3.

<How to respond, when refrigerant is deficient>

- ① Reuse the refrigerant of the broken master unit.

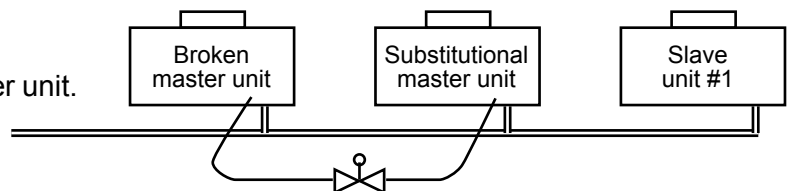

Connect the high pressure service port of the broken master unit and the low pressure service port of the substitutional master unit by charging hose, placing the valve on the way.

>>> Refrigerant release from the heat exchanger of the broken master unit.
(Refrigerant is removed until refrigerant shortage is resolved)

- ② Not available to reuse.
>>> New refrigerant is encapsulated.
* substitutional master unit, and encapsulating amount is recorded.

2. Refrigerant charging after the compressor replacement.

When the refrigerant leaks at the time of replacing the defective compressor, charge the refrigerant as follows depending on the situation.

- ① If the amount of recovered refrigerant is available that was pulled out of outdoor unit which compressor was replaced.
(When the refrigerant is recovered by refrigerant recovery machine, and its weight is measured.)
>>> Perform vacuuming of repaired outdoor unit thoroughly ,
and add the refrigerant with the recovered amount.
- ② If the amount of recovered refrigerant from outdoor unit that compressor was replaced is not sure.
>>> Once recover all units' refrigerant, and then recharge the calculated amount of refrigerant again after vacuuming.

4-5 SERVICE PARTS INFORMATION

SERVICE PARTS INFORMATION 1

Compressor

Diagnosis method of Compressor (If Outdoor Unit 7 segment LED displays Error, refer to Trouble shooting)

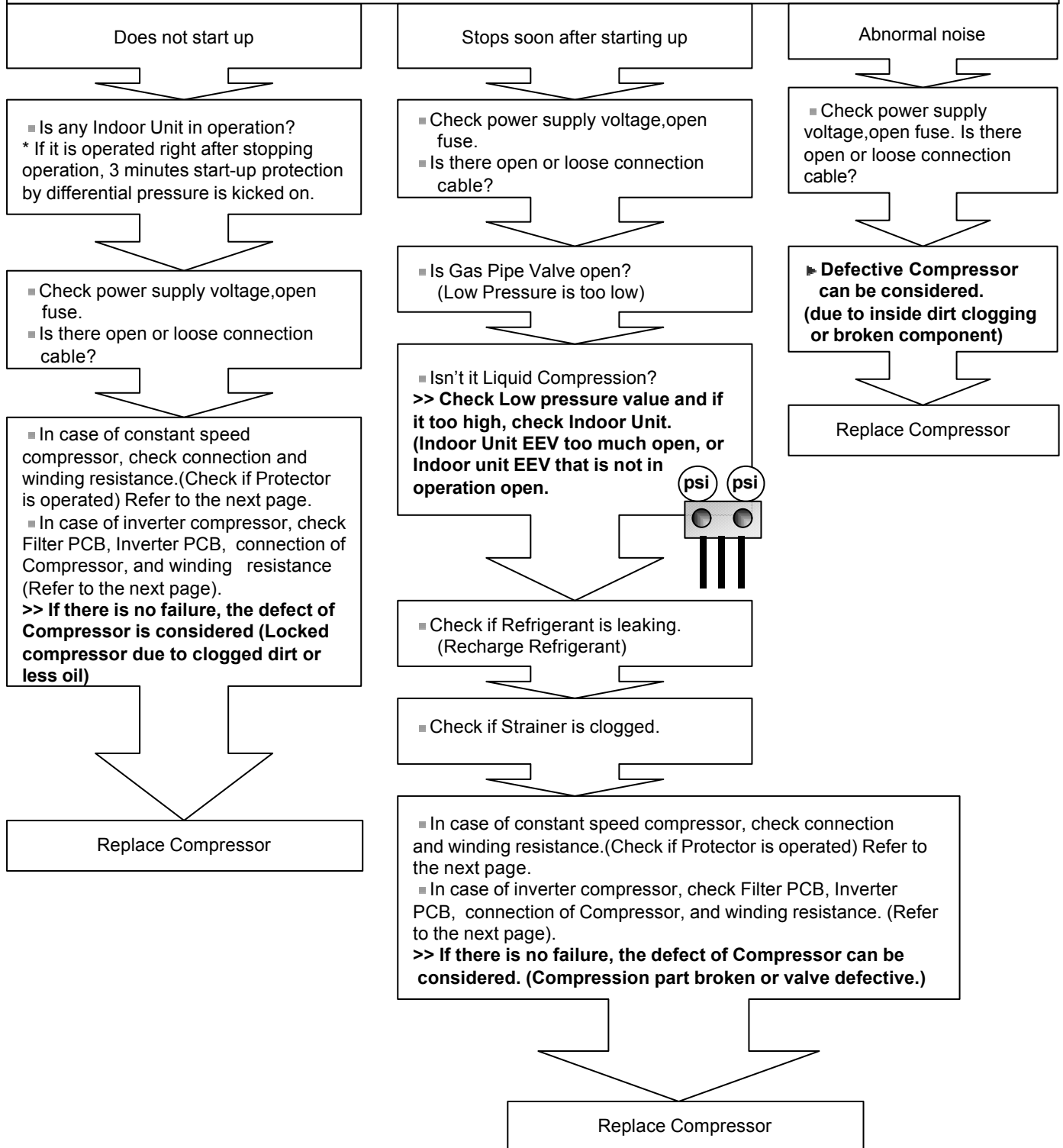

SERVICE PARTS INFORMATION 1

Inverter Compressor

Check Point 1 : Check Connection

- ❑ Check terminal connection of Compressor (loose or incorrect wiring)

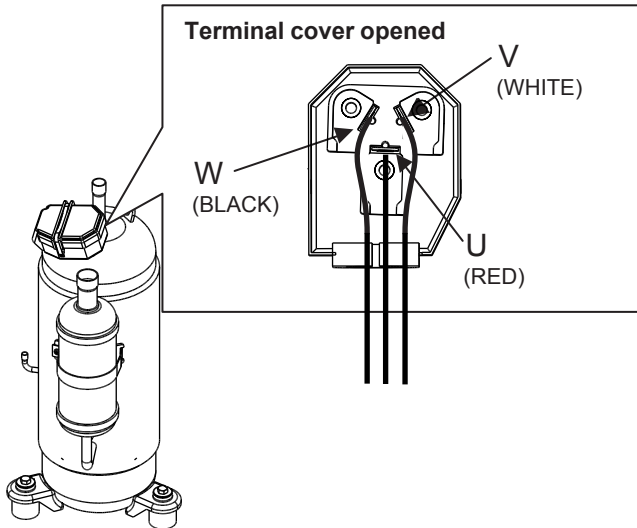

- ❑ Check connection of magnet relay (Loose or incorrect wiring)

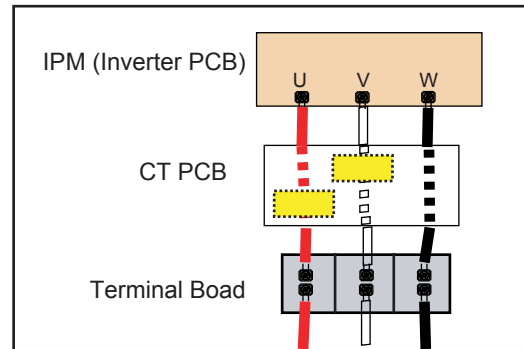

Check Point 2 : Check Winding Resistance

- ❑ Check winding resistance of each terminal
- ▶ **If the resistance value is 0Ω or infinite, replace Compressor.**

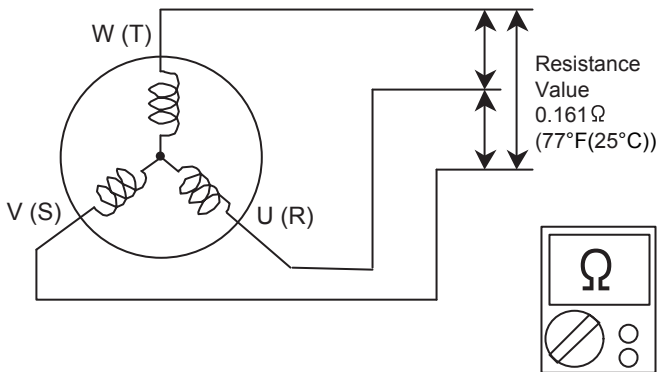

Attention!!

If Check 1, 2 are normal, make sure the following points.

- (1) Check AC voltage among each terminals from filter PCB(INV) to Diode Bridge.
(AC208V - 230V, voltage among L1, L2 and L3).

▶ **If it does not appear, check the power supply terminal.**

- (2) Check Voltage from Main PCB to Inverter PCB.
(DC15.0 - 18.0V between terminals of CN126 (1-2) connector of Main PCB).

▶ **If it does not appear, replace Main PCB.**

- ◆ **If both of above voltages appear, it is considered to be Inverter PCB circuit failure. Replace Inverter PCB and check operation.**



SERVICE PARTS INFORMATION 2

Filter PCB Main PCB

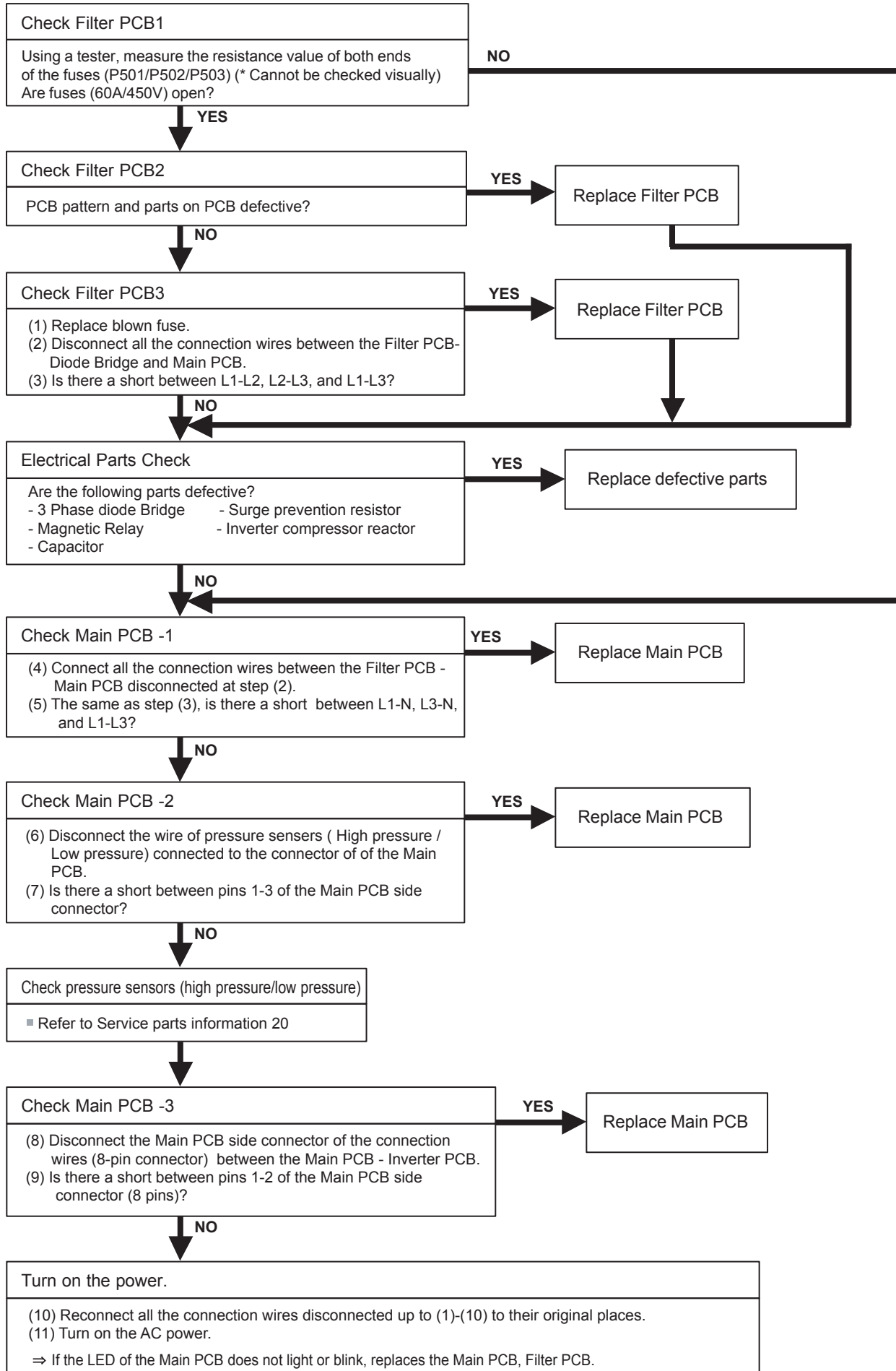

SERVICE PARTS INFORMATION 3

Inverter PCB CT PCB

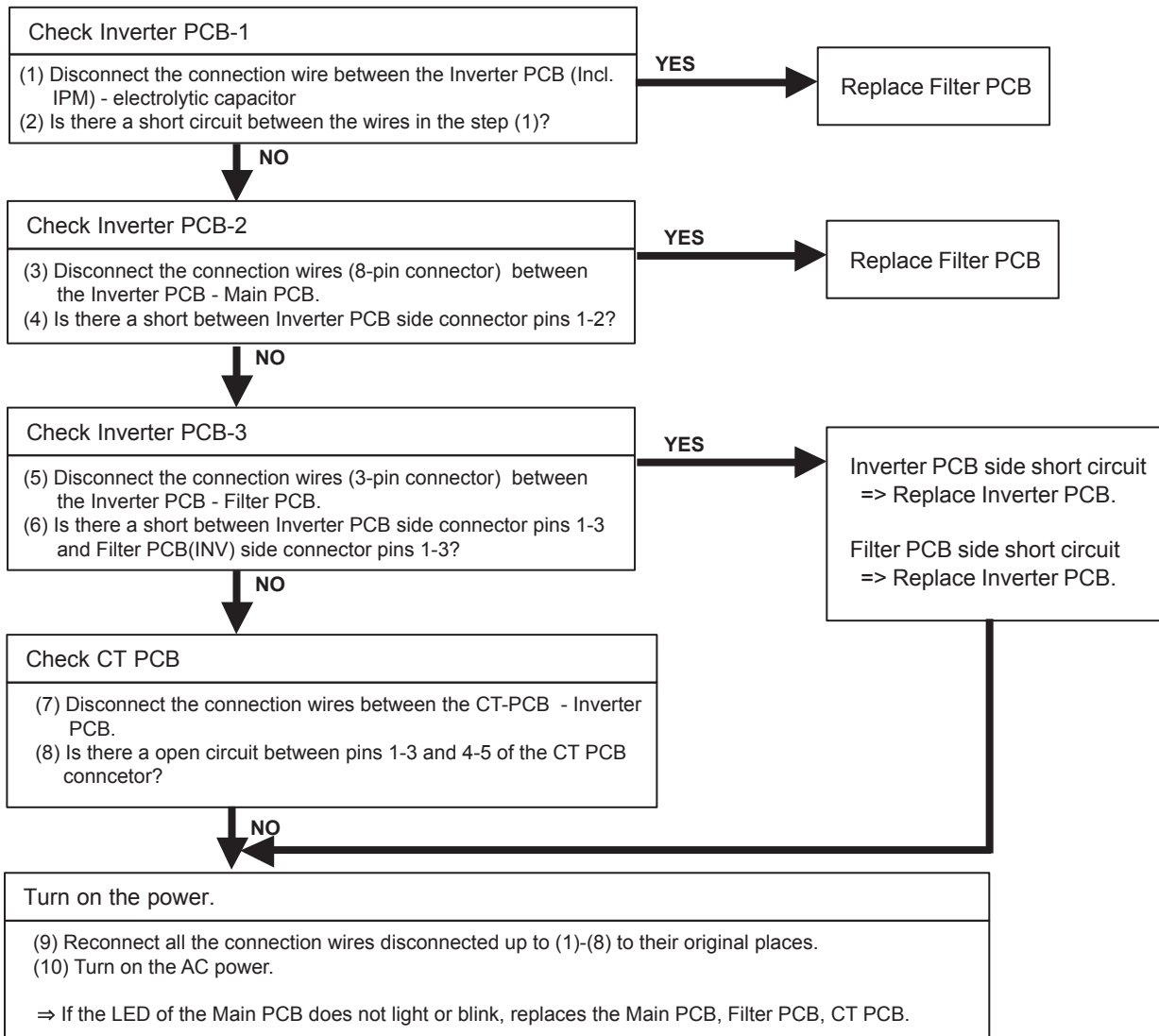

SERVICE PARTS INFORMATION 4

IPM (Mounted on Inverter PCB)

Check Point 1

① Disconnect the connection wires between the Inverter PCB - electrolytic capacitor and Inverter PCB - Inverter Compressor.

② Set the tester to the "Resistance" mode, and measure the resistance between the following terminals.

Screw Terminal P - Screw Terminal U
Screw Terminal P - Screw Terminal V
Screw Terminal P - Screw Terminal W

Screw Terminal N - Screw Terminal U
Screw Terminal N - Screw Terminal V
Screw Terminal N - Screw Terminal W

* Terminal N: Terminal to Capacitor(TM481 on the INV PCB)

③ Judge the result of ② as follows:

All 6 points several MΩ or greater	: Normal
1 or more points several kΩ to short	: Defective

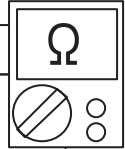
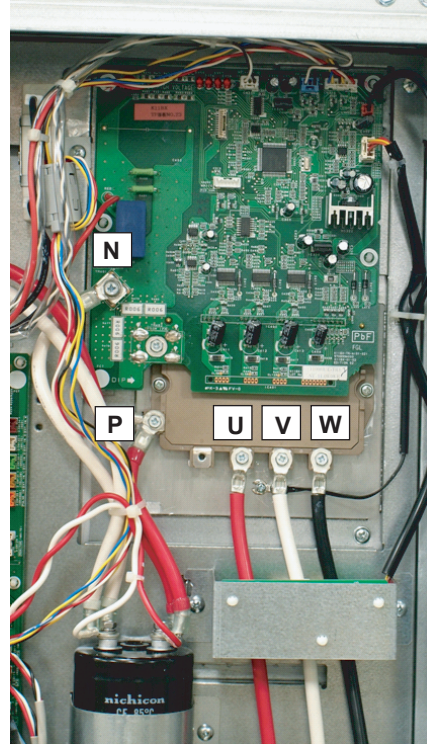

Check Point 2

④ Set the tester to the "Diode" mode, and measure the voltage value between the following terminals.

Tester +side (red)	Tester - side (black)	Tester display [V]
Terminal U	Terminal "P"	
Terminal V		
Terminal W		
Terminal "N"	Terminal U	
	Terminal V	
	Terminal W	

⑤ Judge the result of ④ as follows:

All 6 points several 0.3V to 0.7V	: Normal
1 or more points under 0.1V or over load	: Defective

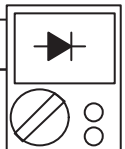

SERVICE PARTS INFORMATION 5

CT PCB

Check Point 1

- Measure the resistance of CT circuit by following procedure.
 1. Turn OFF the Outdoor unit(s) power supply
 2. Measure the resistance value

Good : Less that 330 Ohm NG: More than 330 Ohm

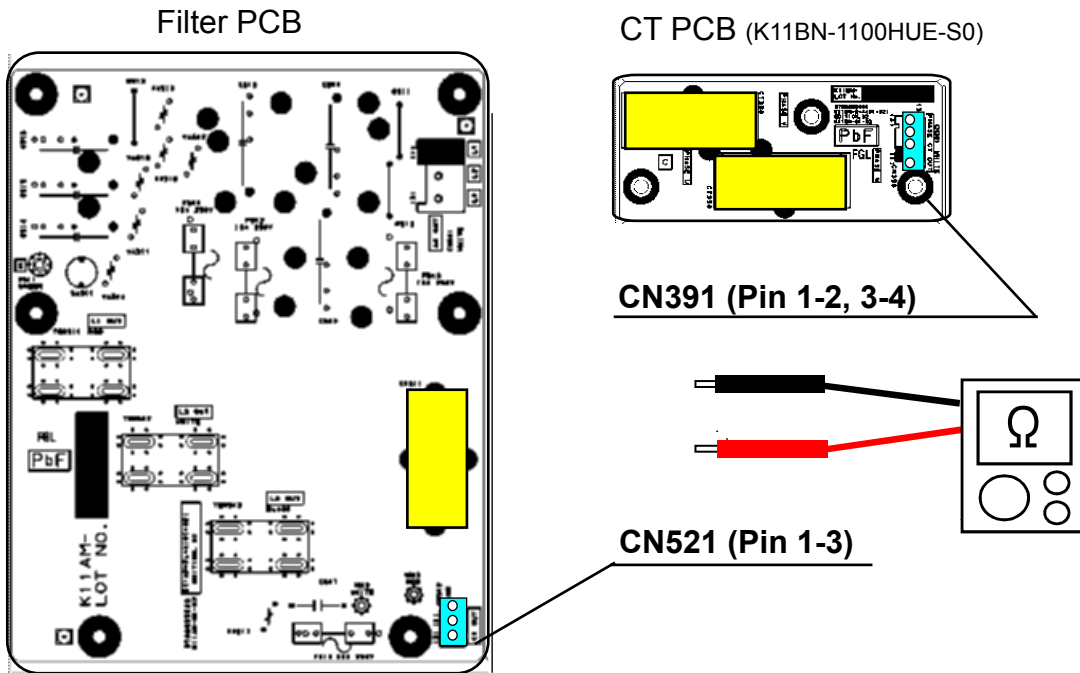

SERVICE PARTS INFORMATION 6

3-Phase Diode Bridge

Check Point 1 : Appearance check

- No fissures, breaks, damage, etc. at body and terminal section?
- Is the rear of the body coated with silicone grease?
- Are there no abnormalities at threaded parts (stripped threads, deformation, damage, etc.)?

Check Point 2 : Electric check



- ① In the 3-phase diode bridge single part state, set the tester to the "Resistance" mode, and check for open/short between the following terminals.

Tester + side (red)	Tester - side (black)
Pin 1	Pin 4
Pin 2	
Pin 3	
Pin 5	Pin 1
	Pin 2
	Pin 3

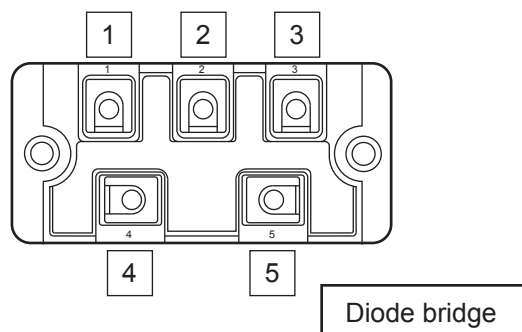

- ② Judge the result of ① as follows:

All 6 points shorted	: Normal
1 or more points open	: Defective

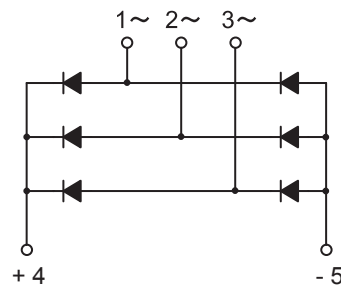

- ③ Set the tester to the "Resistance" mode, and check for open/short between the following terminals.

Tester + side (red)	Tester - side (black)
Pin 4	Pin 1
	Pin 2
	Pin 3
Pin 1	Pin 5
Pin 2	
Pin 3	

- ④ Judge the result of ③ as follows:

All 6 points open	: Normal
1 or more points shorted	: Defective

SERVICE PARTS INFORMATION 7

Reactor (INV)
Reactor (DC Fan)

Check Point 1 : Appearance check

- No fissures, breaks, damage, etc. at the body and winding section, terminals section?

Check Point 2 : Electric check

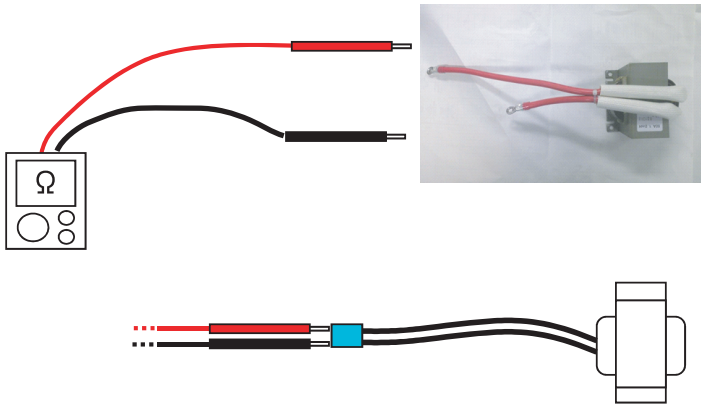

- ① Set the tester to the "Resistance" mode, and check for open/short between both ends of the reactor wire (or connector).
- ② Judge the result of ① as follows:

Short	: Normal
Open	: Abnormal (open)

SERVICE PARTS INFORMATION 8

Resistor, Cement

Check Point 1 : Appearance check

- No fissures, breaks, damage, etc. at the body and terminals section?

Check Point 2 : Electric check



1. Surge prevention resistor (connected to magnetic contactor)

- ① Set the tester to the "Resistance" mode, and measure the resistance value between the terminals.
(No polarity)

- ② Judge the result of ① as follows:

9.00Ω to 11.0Ω	: Normal
Other than the above	: Deteriorated, defective

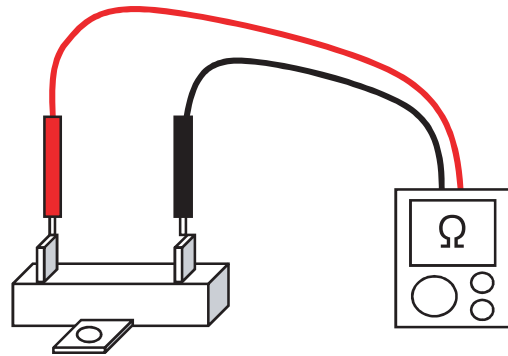

SERVICE PARTS INFORMATION 9

Capacitor

Check Point 1 : Appearance check

- Explosion-proof not operated?
- Electrolyte not leaking?
- No abnormalities at threaded parts? (Stripped threads, deformation, damage, etc.)

Check Point 2 : Electric check

- No short between terminals?



SERVICE PARTS INFORMATION 10

Terminal

Check Point 1 : Appearance check

- No fissures, breaks, damage, etc. at the body and terminals section?
- Not clogged with foreign matter?
- Are there no abnormalities at threaded parts (Stripped threads, deformation, damage, etc.) ?

Check Point 2 : Electric check

- No short between adjacent terminals?
- Conducts before and after same terminal?



SERVICE PARTS INFORMATION 11

Magnetic Relay

Check Point 1 : Appearance check

- No fissures, breaks, damage, etc. at the body and terminals section?
- Are there no abnormalities at threaded parts (Stripped threads, deformation, damage, etc.) ?

Check Point 2 : Electric check

① Set the tester to the "Resistance" mode, and check for open/short between the following terminals. (No polarity)

- Between R to U
- Between S to V
- Between T to W

② Judge the result of ① as follows:

Open	: Normal
Short	: Abnormal (contacts fused)

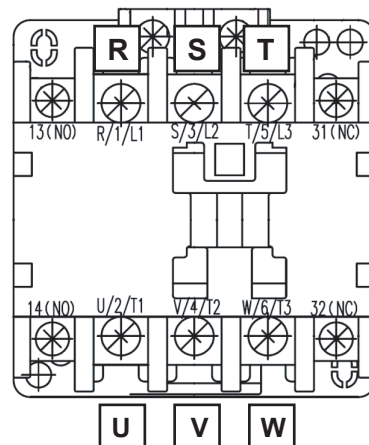

SERVICE PARTS INFORMATION 12

Indoor Unit Electronic Expansion Valve (EEV)

Check Point 1 : Check Connections

- Check Connectors (Loose connector or open cable.)

Duct

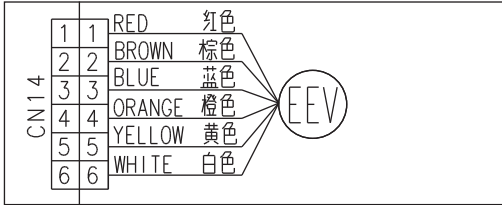

Small Wall mount

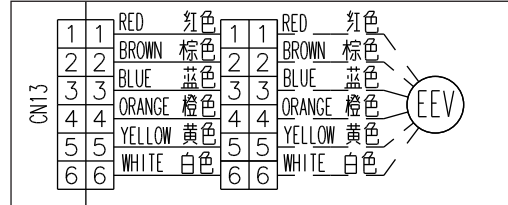

Floor/ Ceiling, Ceiling

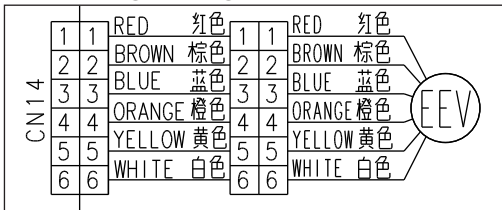

Cassette

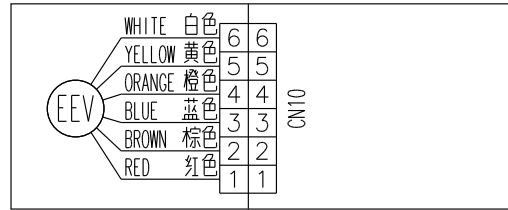

Wall mount

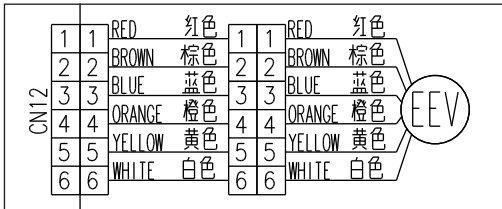

Check Point 2 : Check Coil of EEV

- Remove connector, check each winding resistance of Coil.

Read wire	Resistance value (68°F(20°C))
White - Red	200 ± 10% Ω
Yellow - Brown	
Orange - Red	
Blue - Brown	

- ▶ **If Resistance value is abnormal, replace EEV.**



Check Point 3 : Check Voltage from Controller PCB

- Remove Connector and check Voltage (DC12V).
 >> **If it does not appear, replace Controller PCB.**



Check Point 4 : Check Noise at start up

- Turn on Power and check operation noise.
 >> **If an abnormal noise does not show, replace Controller PCB.**

Check Point 5 : Check Opening and Closing Operation of Valve

When Valve is closed, it has a temp. difference between Inlet and Outlet.

If it is open, it has no temp. difference between Inlet and Outlet.

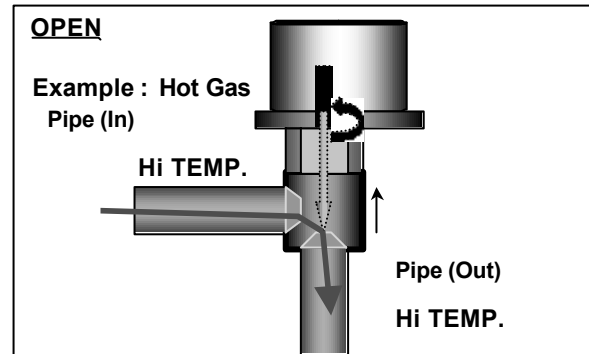
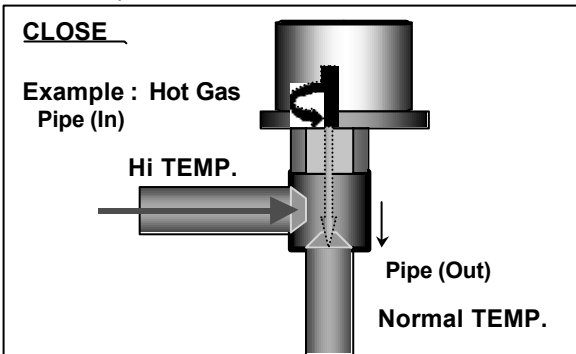

Check Point 6 : Check Strainer

Strainer normally does not have temperature difference between inlet and outlet as shown in (1), but if there is a difference as shown in (2), there is a possibility of inside clogged. In this case, replace Strainer.

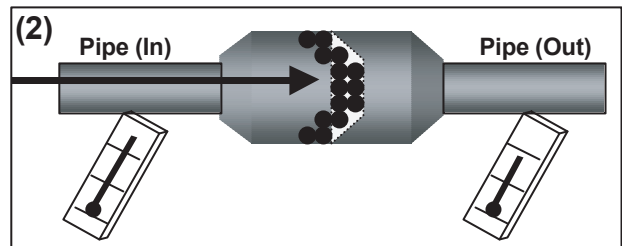
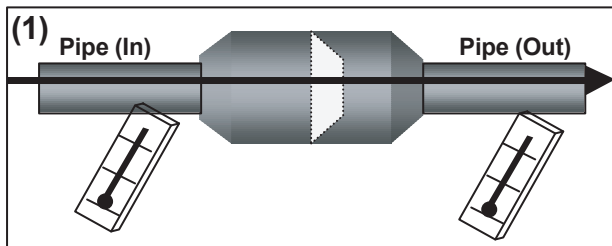

SERVICE PARTS INFORMATION 13

Outdoor Unit Electronic Expansion Valve (EEV1)

Check Point 1 : Check Connections

- Check connection of connector (CN116)
(Loose connector or open cable)

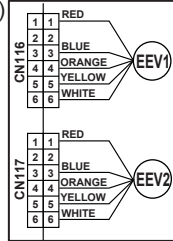

Check Point 2 : Check Coil of EEV1

- Remove connector, check each winding resistance of Coil.

Read wire	Resistance value (68°F(20°C))
White - Red	$46 \pm 4 \% \Omega$ 
Yellow - Red	
Orange - Red	
Blue - Red	

▶ If Resistance value is abnormal, replace EEV.

Check Point 3 : Check Voltage from Controller PCB

- Remove Connector and check Voltage (DC12V).
>> **If it does not appear, replace Controller PCB.**



Check Point 4 : Check Noise at start up

- Turn on Power and check operation noise.
>> **If an abnormal noise does not show, replace Controller PCB.**

Check Point 5 : Check Opening and Closing Operation of Valve

When Valve is closed,
it has a temp. difference between Inlet and Outlet.

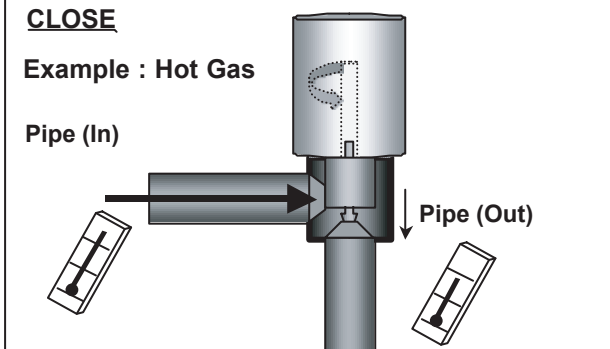

If it is open, it has no temp. difference between Inlet and Outlet.

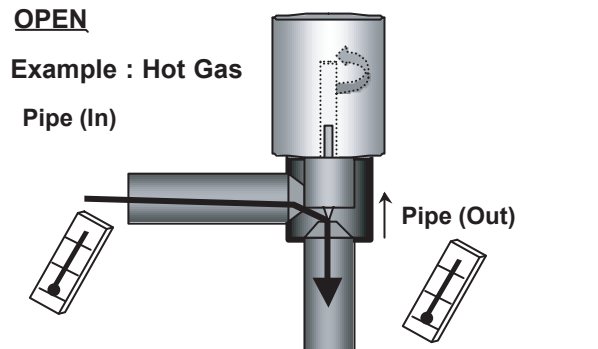

Check Point 6 : Check Strainer

Strainer normally does not have temperature difference between inlet and outlet as shown in (1), but if there is a difference as shown in (2), there is a possibility of inside clogged. In this case, replace Strainer.

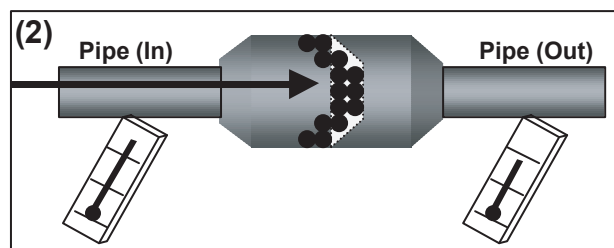
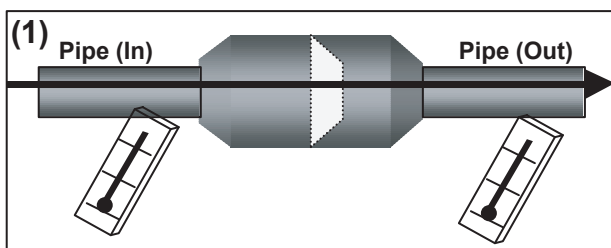

SERVICE PARTS INFORMATION 14

Outdoor Unit Electronic Expansion Valve (EEV2)

Check Point 1 : Check Connections

- Check connection of connector (CN117)
(Loose connector or open cable)

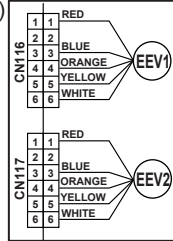

Check Point 2 : Check Coil of EEV2

- Remove connector, check each winding resistance of Coil.

Read wire	Resistance value (68°F(20°C))
White - Red	$46 \pm 4\% \Omega$ 
Yellow - Red	
Orange - Red	
Blue - Red	

▶ If Resistance value is abnormal, replace EEV.

Check Point 3 : Check Voltage from Controller PCB

- Remove Connector and check Voltage (DC12V).
>> **If it does not appear, replace Controller PCB.**



Check Point 4 : Check Noise at start up

- Turn on Power and check operation noise.
>> **If an abnormal noise does not show, replace Controller PCB.**

Check Point 5 : Check Opening and Closing Operation of Valve

When Valve is closed,
it has a temp. difference between Inlet and Outlet.

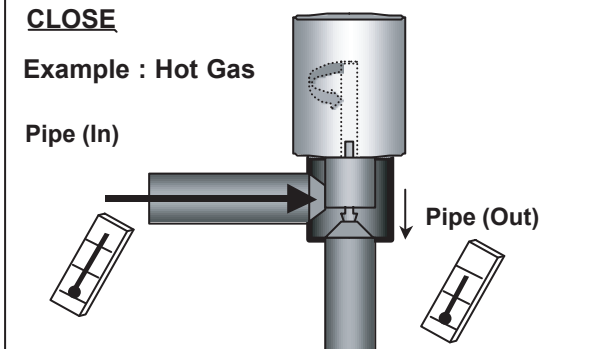

If it is open, it has no temp. difference between Inlet and Outlet.

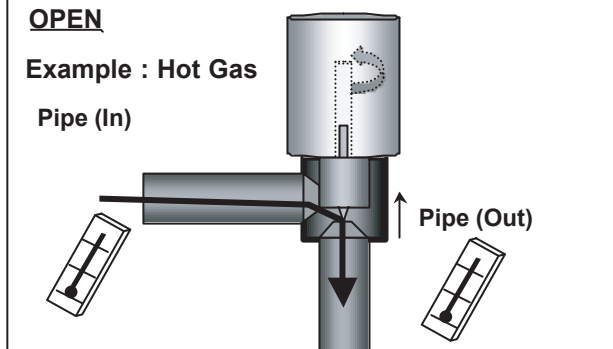

Check Point 6 : Check Strainer

Strainer normally does not have temperature difference between inlet and outlet as shown in (1), but if there is a difference as shown in (2), there is a possibility of inside clogged. In this case, replace Strainer.

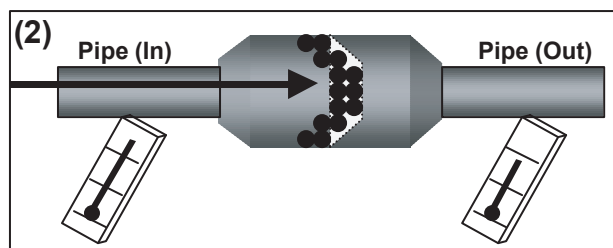
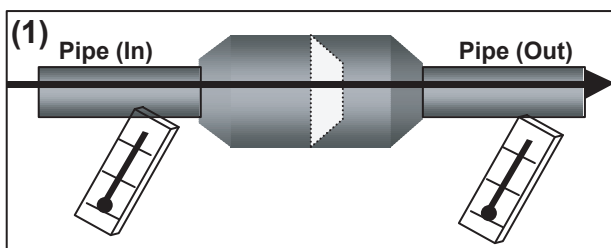

SERVICE PARTS INFORMATION 15

Outdoor Unit Solenoid Valve (SV1,SV2,SV3,)

Check Point 1 : Check connections

- Check connection of connector.
(Loose connector or open cable)

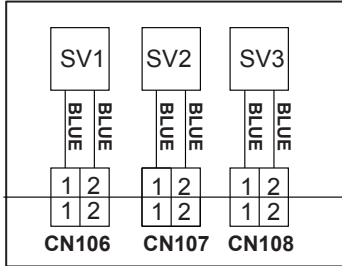

Check Point 2 : Check Solenoid Coil

- Remove connector and check if coil is open.
Normal resistance value
SV1 : $1183 \pm 7\% \Omega$
SV2, SV3: $1298 \pm 7\% \Omega$

>> **If Resistance value is abnormal, replace Solenoid Coil.**

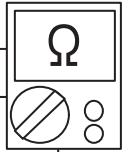

Check Point 3 : Check Voltage from Controller PCB

- Remove connector and check the voltage (AC208~230V).

>> **If the voltage does not appear, replace Controller PCB.**

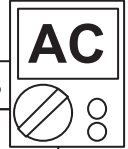

Check Point 4 : Check opening & closing operation of Valve

- Depending on either during operation or protection control, check if Valve is operating normally.
(When Valve opens, there is no temperature difference between Inlet and Outlet.)

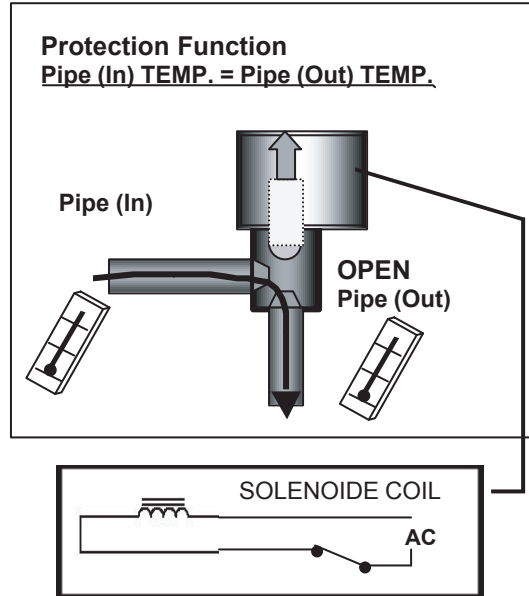
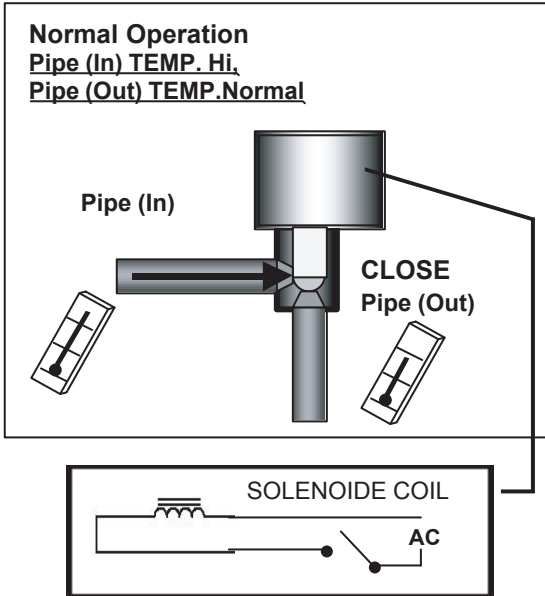

- If the valve closes by removing the connector of the valve which does not close, it is considered to be Controller PCB failure. Replace Controller PCB.

- If it does not close by removing connector, there is a possibility of (1) clogging by dirt, or (2) deformation by the heat at the time of Solenoid Valve installation.
In this case, replace Solenoid Valve.

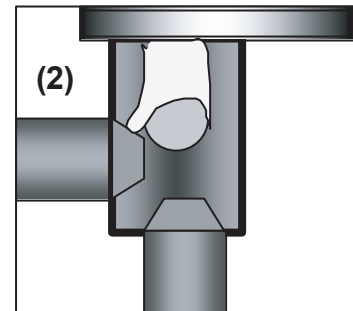
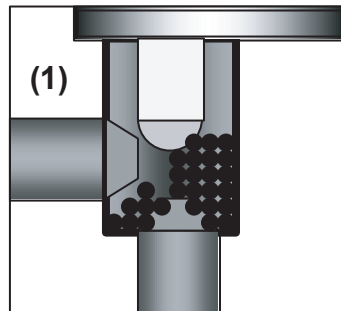

SERVICE PARTS INFORMATION 16

4-WAY VALVE

Check Point 1 : Check Circuit connection

- Check the connection of connector CN 105

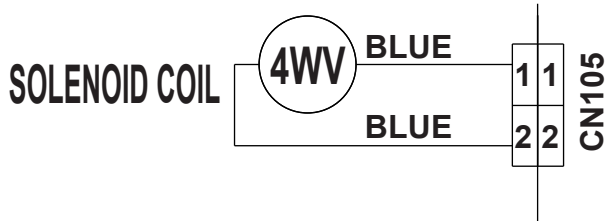

Check Point 2 : Check Solenoid Coil

- Remove CN6 from PCB and check the resistance value of coil

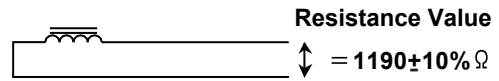

- ☆ If it is Open or abnormal resistance value, replace Solenoid Coil

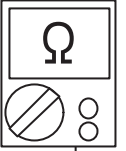

Check Point 3: Check Operation of 4 Way Valve

- Check each piping temperature, and confirm the location of the valve by the temperature difference.

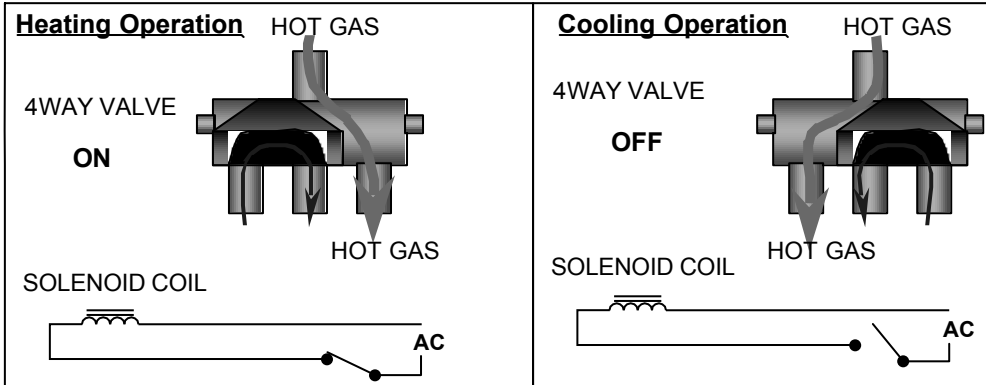

- ☆ If the valve location is not proper, replace 4 way valve.

Check Point 4: Check Voltage of Solenoid Coil

- If CN105 of Controller PCB does not Show $208 \sim 230V \pm 20V$ during Heating operation (Compressor is in operation), replace Controller PCB.

SERVICE PARTS INFORMATION 17

Indoor unit fan motor < DC motor >

- AUUA 7,9,12,14,18 ,24
- AUUB18,24,30,36,
- ARUL 7,9,12,14,18
- ABUA12,14,18,24,30,36
- ASUA 7,9,12,14
- ASUB 18,24

⚠ When you approach this part, please cut off the power supply and wait for a while until DC voltage has been discharged.

Check Point 1 : Check rotation of Fan

- Rotate the fan by hand when operation is off.
(Check if fan is caught, dropped off or locked motor)
- >>If Fan or Bearing is abnormal, replace it.**

Check Point 2 : Check resistance of Indoor Fan Motor

- Refer to below. Circuit-test "Vm" and "GND" terminal.
(Vm: DC voltage, GND: Earth terminal)
- >>If they are short-circuited (below 300 kΩ), replace Indoor fan motor and Controller PCB.**

Pin number (wire color)	Terminal function (symbol)
1 (Blue)	Feed back (FG)
2 (Yellow)	Speed command (Vsp)
3 (White)	Control voltage (Vcc)
4 (Black)	Earth terminal (GND)
5	No function
6 (Red)	DC voltage (Vm)

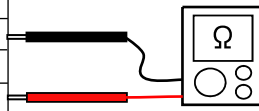

SERVICE PARTS INFORMATION 18

Outdoor unit fan motor

⚠ When you approach this part, please cut off the power supply and wait for a while until DC voltage has been discharged.

Check Point 1 : Check rotation of Fan

- Rotate the fan by hand when operation is off.
(Check if fan is caught, dropped off or locked motor)
- >>If Fan or Bearing is abnormal, replace it.**

Check Point 2 : Check resistance of Outdoor Fan Motor

- Refer to below. Circuit-test "Vm" and "GND" terminal.
(Vm: DC voltage, GND: Earth terminal)
- >>If they are short-circuited (below 300 kΩ), replace Outdoor fan motor.**

Pin number (wire color)	Terminal function (symbol)
1 (Red)	DC voltage (Vm)
2	No function
3	No function
4 (Black)	Earth terminal (GND)
5 (White)	Control voltage (Vcc)
6 (Yellow)	Speed command (Vsp)
7 (Brown or Blue)	Feed back (FG)

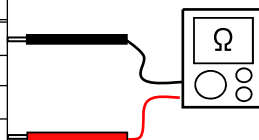

SERVICE PARTS INFORMATION 19

Indoor Unit Fan Motor < AC Motor 1/2 >

Check Point : ARUA24,30 (Duct Type)

- Check each winding resistance of the motor
- ▶ **If Resistance value is abnormal, replace motor.**

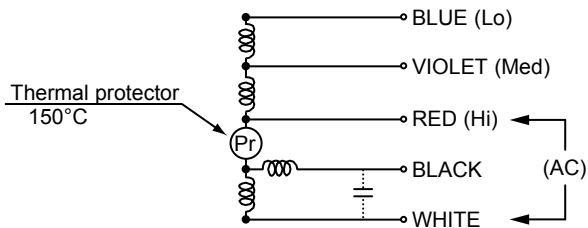

Lead wire	Resistance value
White – Red	$33.5 \Omega \pm 8\%$
Red – Black	$17.2 \Omega \pm 8\%$
Red – Violet	$4.25 \Omega \pm 8\%$
Violet – Blue	$4.25 \Omega \pm 8\%$

at 68°F (20°C)

Check Point : ARUA36 (Duct Type)

- Check each winding resistance of the motor
- ▶ **If Resistance value is abnormal, replace motor.**

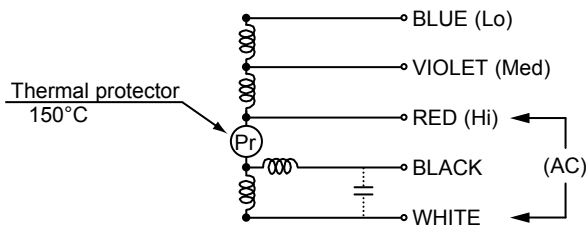

Lead wire	Resistance value
White – Red	$14.3 \Omega \pm 8\%$
Red – Black	$13.5 \Omega \pm 8\%$
Red – Violet	$2.01 \Omega \pm 8\%$
Violet – Blue	$2.01 \Omega \pm 8\%$

at 68°F (20°C)

Check Point : ARUC36 (High static Duct Type)

- Check each winding resistance of the motor
- ▶ **If Resistance value is abnormal, replace motor.**

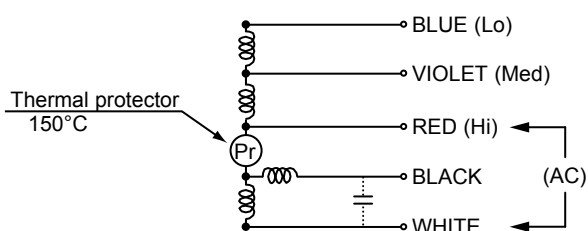

Lead wire	Resistance value
White – Red	$19.8 \Omega \pm 8\%$
Red – Black	$24.2 \Omega \pm 8\%$
Pink – Violet	$9.19 \Omega \pm 8\%$
Violet – Blue	$9.10 \Omega \pm 8\%$

at 68°F (20°C)

SERVICE PARTS INFORMATION 19

Indoor Unit Fan Motor < AC Motor 2/2 >

Check Point : ARUC48, 54 (Duct Type)

- Check each winding resistance of the motor
- ▶ **If Resistance value is abnormal, replace motor.**

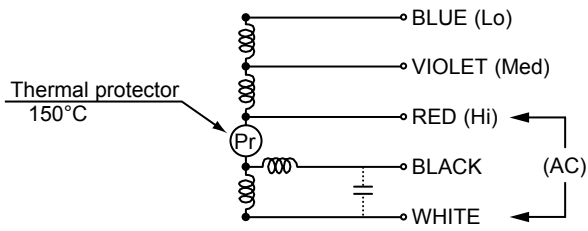

Lead wire	Resistance value
White – Red	9.13 Ω \pm 8%
Red – Black	9.81 Ω \pm 8%
Red – Violet	3.71 Ω \pm 8%
Violet – Blue	2.93 Ω \pm 8%

at 68°F (20°C)

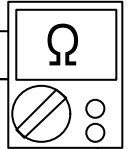

SERVICE PARTS INFORMATION 20

Discharge Pressure Sensor Suction Pressure Sensor

1. Discharge Pressure Sensor

Check Point : Check Voltage from Main PCB

- With the connector connected to the PCB, measure the voltage between CN118:2-3 of the Main PCB.

- Characteristics of pressure sensor

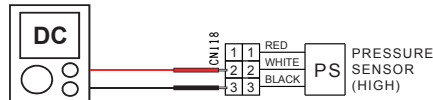
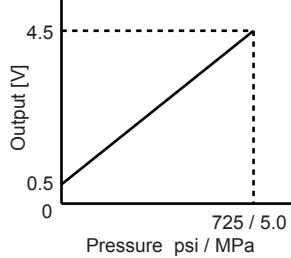

psi	0.0	14.5	29.0	43.5	58.0	72.5	101.5	116.0	130.5	145.0	174.0	203.0	232.0	261.0	290.0
MPa	0.00	0.10	0.20	0.30	0.40	0.50	0.70	0.80	0.90	1.00	1.20	1.40	1.60	1.80	2.00
Output (V)	0.50	0.58	0.66	0.74	0.82	0.90	1.06	1.14	1.22	1.30	1.46	1.62	1.78	1.94	2.10

psi	319.0	348.0	377.0	406.0	435.0	464.0	493.0	522.0	551.0	580.0	609.0	638.0	667.0	696.0	725.0
MPa	2.20	2.40	2.60	2.80	3.00	3.20	3.40	3.60	3.80	4.00	4.20	4.40	4.60	4.80	5.00
Output (V)	2.26	2.42	2.58	2.74	2.90	3.06	3.22	3.38	3.54	3.70	3.86	4.02	4.18	4.34	4.50

2. Suction Pressure Sensor

Check Point : Check Voltage from Main PCB

- With the connector connected to the PCB, measure the voltage between CN119:2-3 of the Main PCB.

- Characteristics of pressure sensor

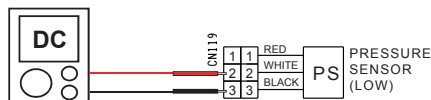
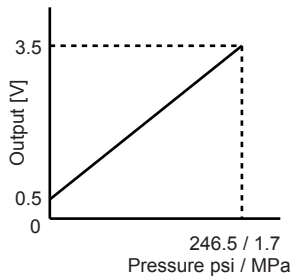

psi	0.0	14.5	29.0	43.5	58.0	72.5	101.5	116.0	130.5	145.0	159.5	174.0	188.5	203.0	217.5
MPa	0.00	0.10	0.20	0.30	0.40	0.50	0.70	0.80	0.90	1.00	1.10	1.20	1.30	1.40	1.50
Output (V)	0.50	0.68	0.85	1.03	1.21	1.38	1.74	1.91	2.09	2.27	2.44	2.62	2.79	2.97	3.15

psi	232.0	246.5
Mpa	1.60	1.70
Output (V)	3.32	3.50

SERVICE PARTS INFORMATION 21

Pressure switch 1

- Type of contact

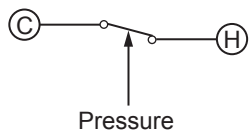

- Characteristics of pressure switch

Contact : Short ⇒ Open	4.2±0.1MPa	609 ±14.5 psi
Contact : Open ⇒ Short	3.2±0.15MPa	464 ±21.8 psi

SERVICE PARTS INFORMATION 22

Thermistor

Check Point : Check Thermistor resistance value

- Remove connector and check Thermistor resistance value.

Temperature [°F]	Temperature [°C]	Resistance Value [kΩ]			
		Thermistor A	Thermistor B	Thermistor C	Thermistor D
- 4	- 20	---	---	105.4	---
14	- 10	---	27.8	58.2	27.4
23	- 5	---	21.0	44.0	20.7
32	0	168.6	16.1	33.6	15.8
41	5	129.8	12.4	25.9	12.2
50	10	100.9	9.6	20.2	9.5
59	15	79.1	7.6	15.8	7.5
68	20	62.6	6.0	12.5	5.9
77	25	49.8	4.8	10.0	4.7
86	30	40.0	3.8	8.0	3.8
104	40	26.3	2.5	5.3	2.5
122	50	17.8	1.7	3.6	1.7
140	60	12.3	1.2	---	1.2
158	70	8.7	---	---	0.8
176	80	6.3	---	---	0.6
194	90	4.6	---	---	0.4
212	100	3.4	---	---	0.3
230	110	2.6	---	---	---
248	120	2.0	---	---	---
Applicable Thermistors	Discharge temp. TH1	Heat exchanger. TH	Outdoor temp. TH	Heat sink temp. TH	
	Comp.1 temp. TH	Suction temp. TH Sub-cool heat exchanger (inlet) TH Sub-cool heat exchanger (outlet) TH Liquid temp. TH1 Liquid temp. TH2			

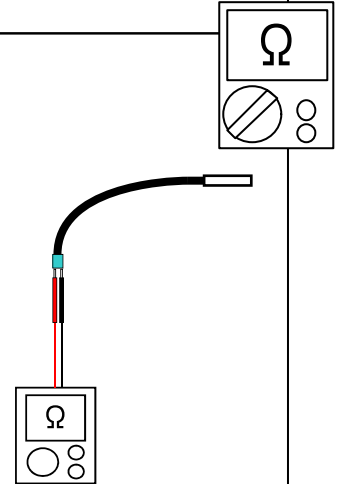

AIRSTAGE™ V-II

Variable Refrigerant Flow System

5. APPENDING DATA (UNIT)

5-1 REFRIGERANT CIRCUIT

MODELS : AOUA72RLBV, AOUA96RLBV

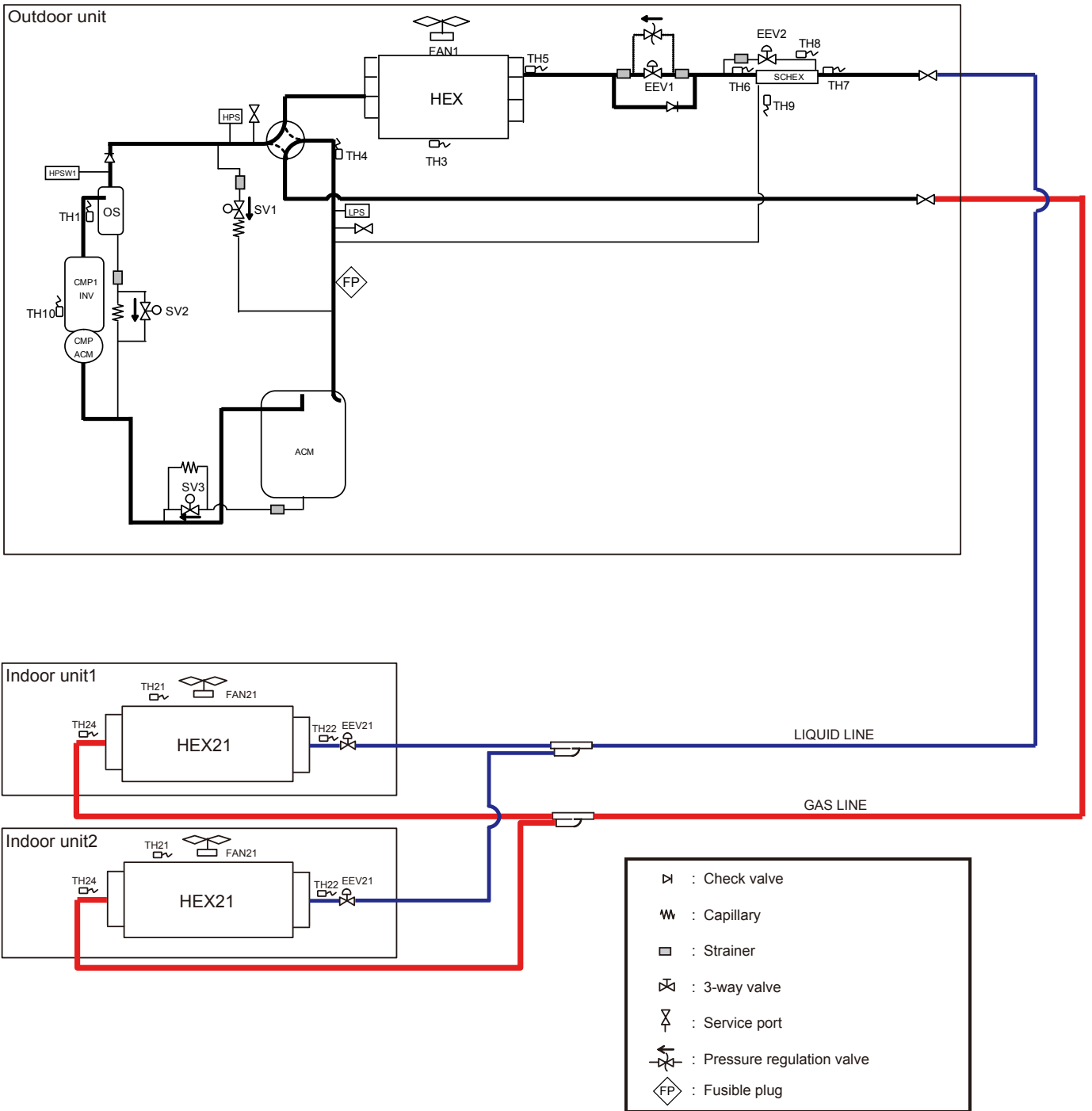

5-1 REFRIGERANT CIRCUIT for Outdoor air unit

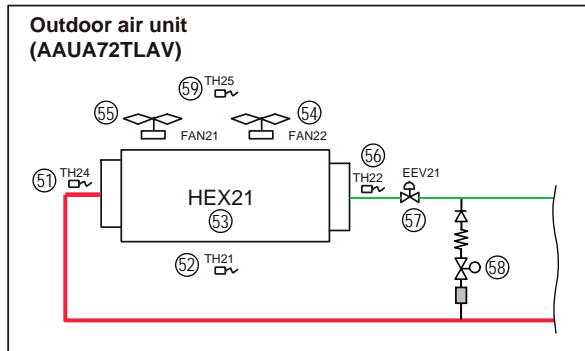
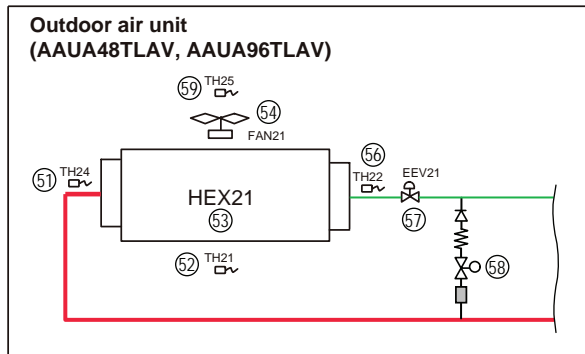

-W- : Capillary □ : Strainer

No.	Part name	Function
51	Heat exchanger outlet thermistor	Detects the temperature of refrigerant
52	Suction airflow temp. thermistor	Detects the temperature of suction airflow
53	Heat exchanger	Operates as Condensor / Evapulator
54	Fan motor	Controlled by setting / protection / Compressor OFF
55	Fan motor	Controlled by setting / protection / Compressor OFF
56	Heat exchanger inlet thermistor	Detects the temperature of refrigerant
57	Electric expansion valve	Controlled by setting / protection / Compressor OFF
58	Solenoid valve (Bypass)	Opens at compressor OFF in Heating mode
59	Discharge airflow temp. thermistor	Detects the temperature of discharge airflow

SYMBOL DESCRIPTION

Outdoor unit

MARK	DESCRIPTION	
CMP 1	Compressor 1 (Inverter type)	
HEX	Heat exchanger	
FAN 1	Fan 1	
ACM	Accumulator	
OS	Oil separator	
SCHEX	Sub-cool heat exchanger	
HPS	High pressure sensor	
LPS	Low pressure sensor	
HPSW1	High pressure sensor switch 1	
4WV	4-way valve	
EEV 1	Electric expansion valve 1	
EEV 2	Electric expansion valve 2	
SV 1*	Solenoid valve 1	
SV 2*	Solenoid valve 2	
SV 3*	Solenoid valve 3	
TH 1	Discharge temperature thermistor 1	Blue
TH 3	Outdoor temperature thermistor	Yellow
TH 4	Suction temperature thermistor	Green
TH 5	Heat exchanger (outlet) thermistor	–
TH 6	Liquid temperature thermistor 1	Gray
TH 7	Liquid temperature thermistor 2	Green
TH 8	Sub-cool heat exchanger (inlet) thermistor	White
TH 9	Sub-cool heat exchanger (outlet) thermistor	Red
TH 10	Compressor 1 temperature thermistor	–

*Function of each Solenoid valve.
 SV 1 - DISCHARGE GAS BYPASS
 SV 2 - INVERTER COMPRESSOR BYPASS
 SV 3 - ACCUMULATOR OIL BYPASS

Indoor unit

MARK	DESCRIPTION
HEX 21	Heat exchanger
FAN 21	Fan
EEV 21	Electric expansion valve
TH 21	Room temperature thermistor
TH 22	Heat exchanger (inlet) thermistor
TH 24	Heat exchanger (outlet) thermistor

5-2 WIRING DIAGRAM

5-2-1 Indoor Unit

■ COMPACT CASSETTE TYPE

MODELS : AUUA7RLAV, AUUA9RLAV, AUUA12RLAV, AUUA14RLAV, AUUA18RLAV, AUUA24RLAV

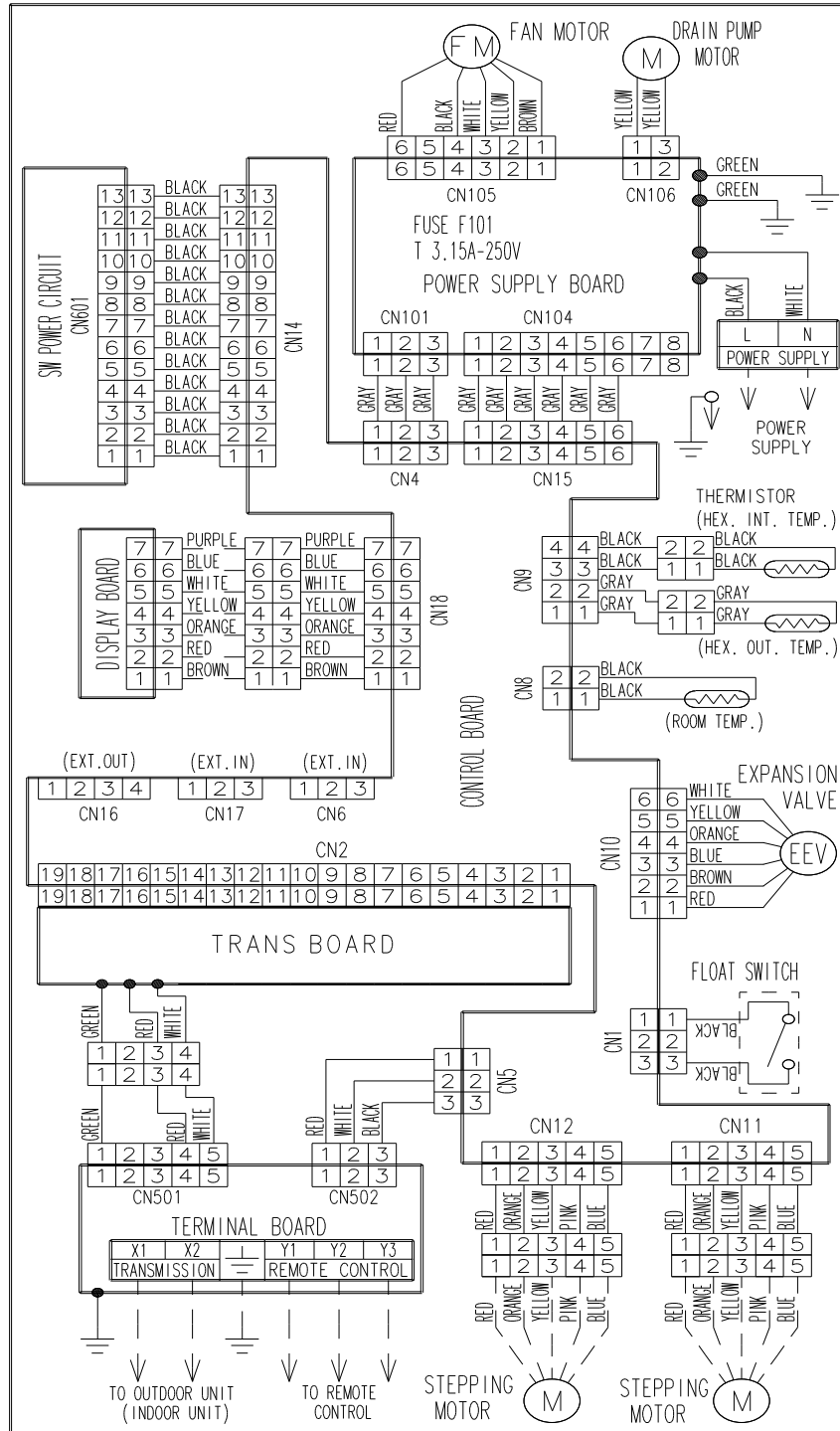

■ CASSETTE TYPE

MODELS : AUUB18RLAV, AUUB24RLAV, AUUB30RLAV, AUUB36RLAV

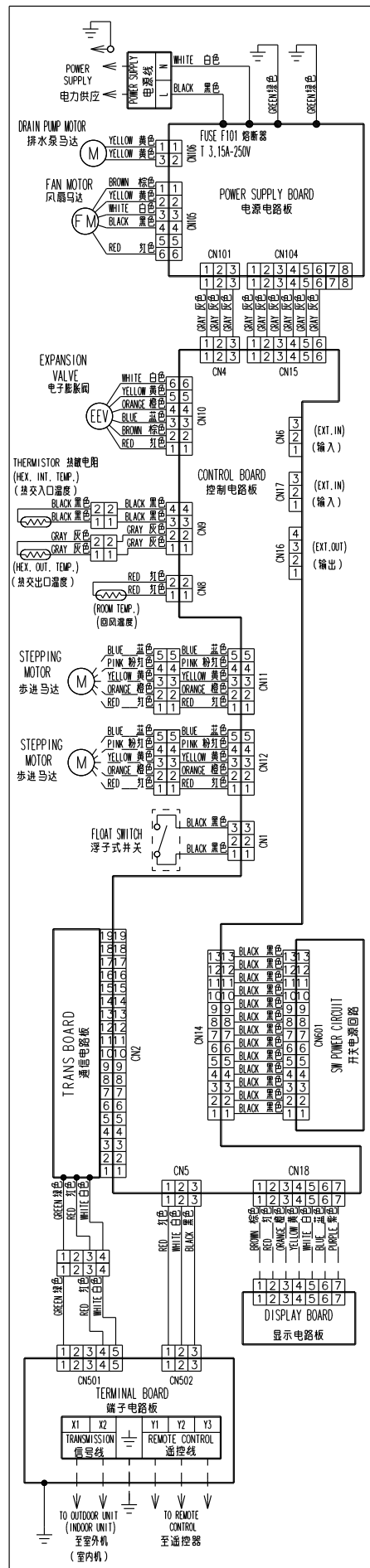

SLIM DUCT TYPE

MODELS : ARUL7RLAV, ARUL9RLAV, ARUL12RLAV,
ARUL14RLAV, ARUL18RLAV

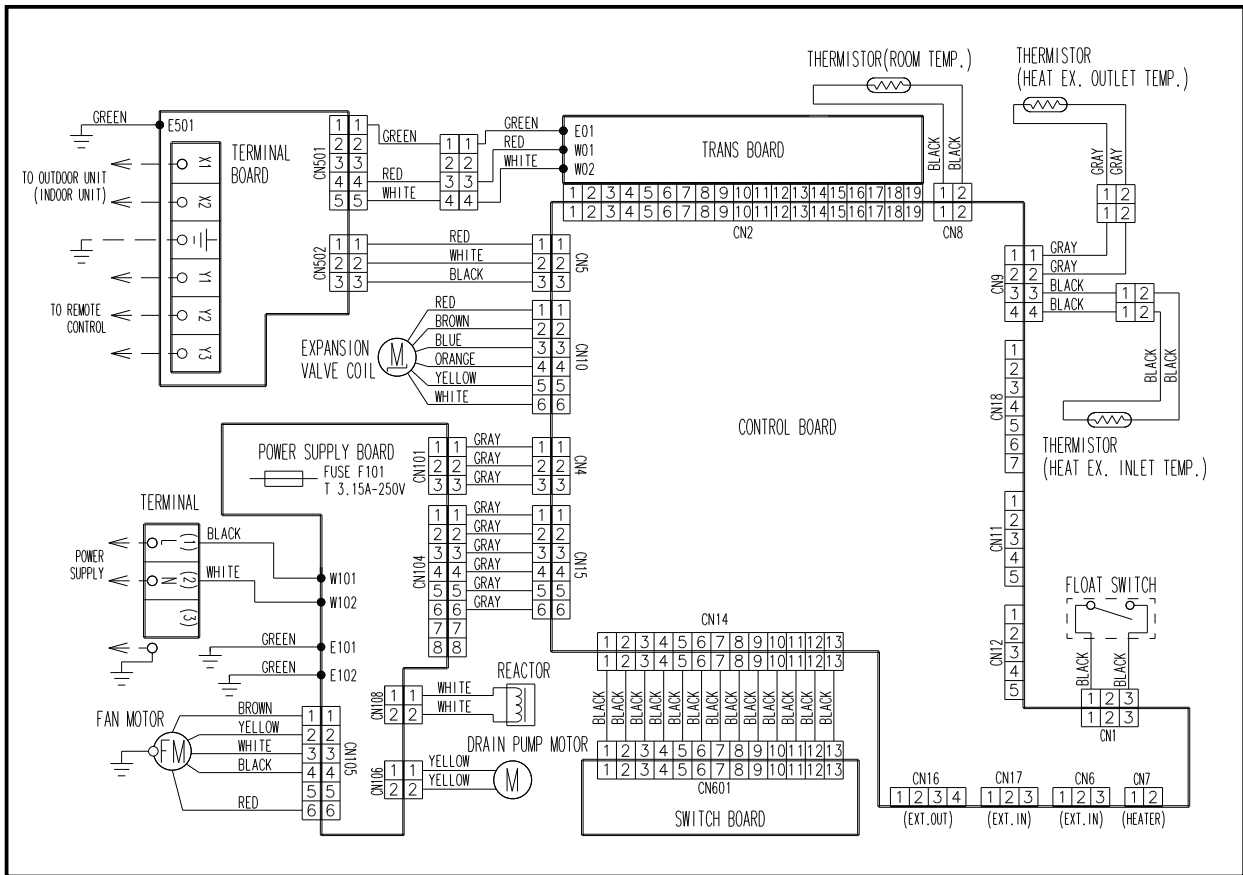

DUCT TYPE

MODELS : ARUM24RLAV, ARUM30RLAV, ARUM36RLAV

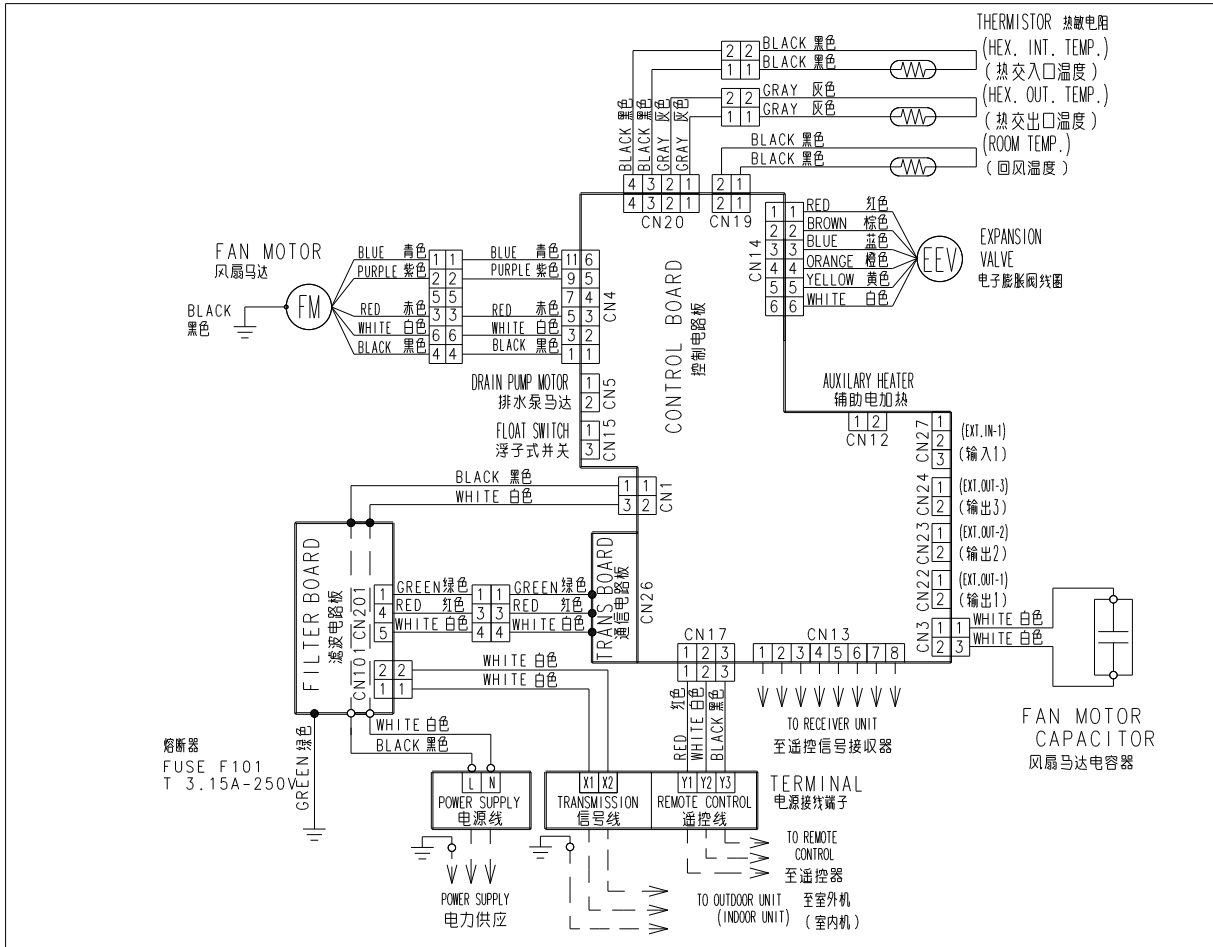

■ HIGH STATIC PRESSURE DUCT TYPE

MODELS : ARUH36RLAV, ARUH48RLAV, ARUH54RLAV

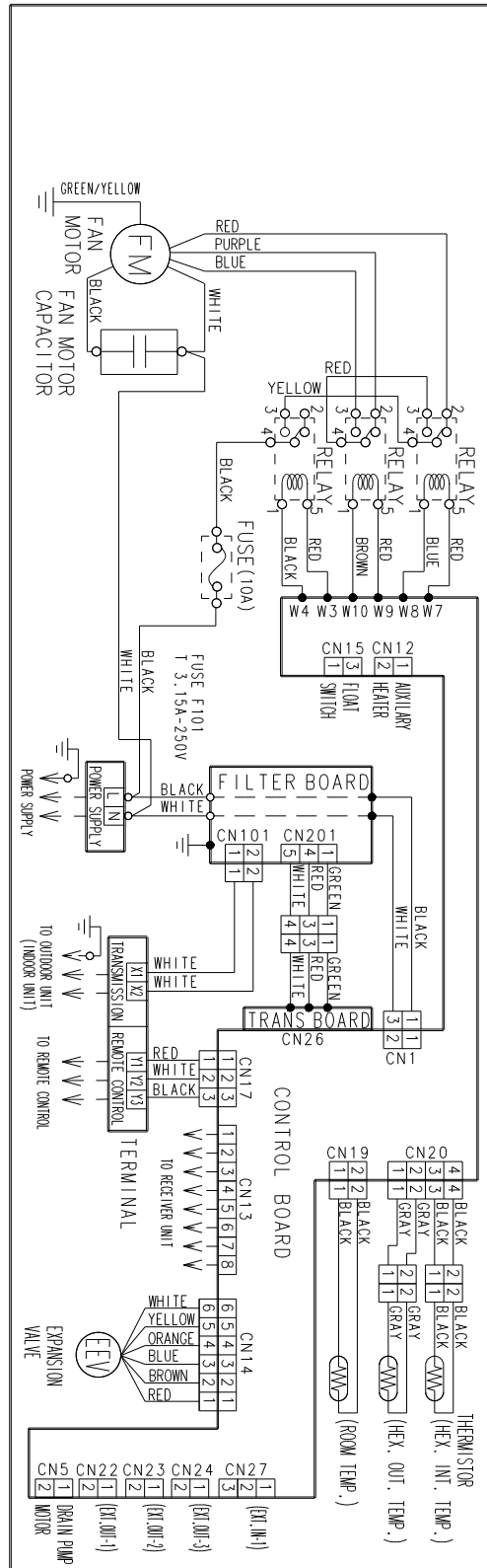

■ FLOOR / CEILING TYPE

MODELS : ABUA12RLAV, ABUA14RLAV, ABUA18RLAV, ABUA24RLAV

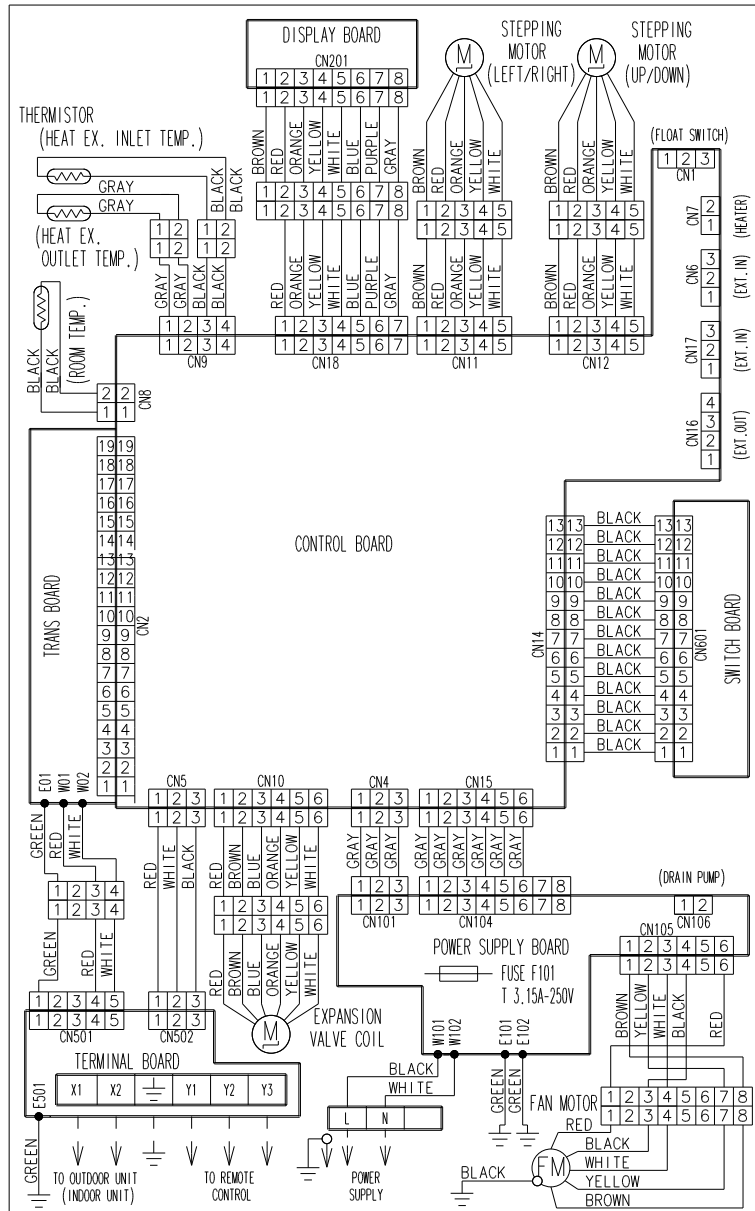

■ CEILING TYPE

MODELS : ABUA30RLAV, ABUA36RLAV

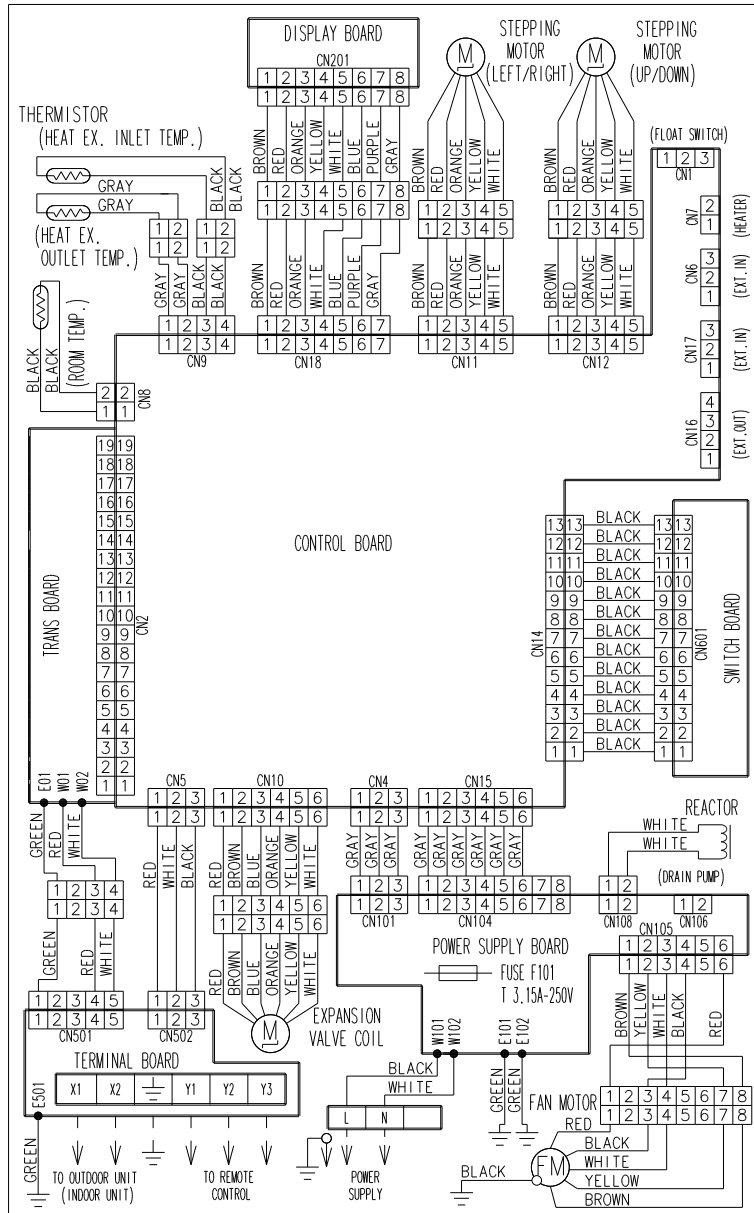

5-2-2 Outdoor Unit

MODELS : AOUA72RLBV, AOUA96RLBV

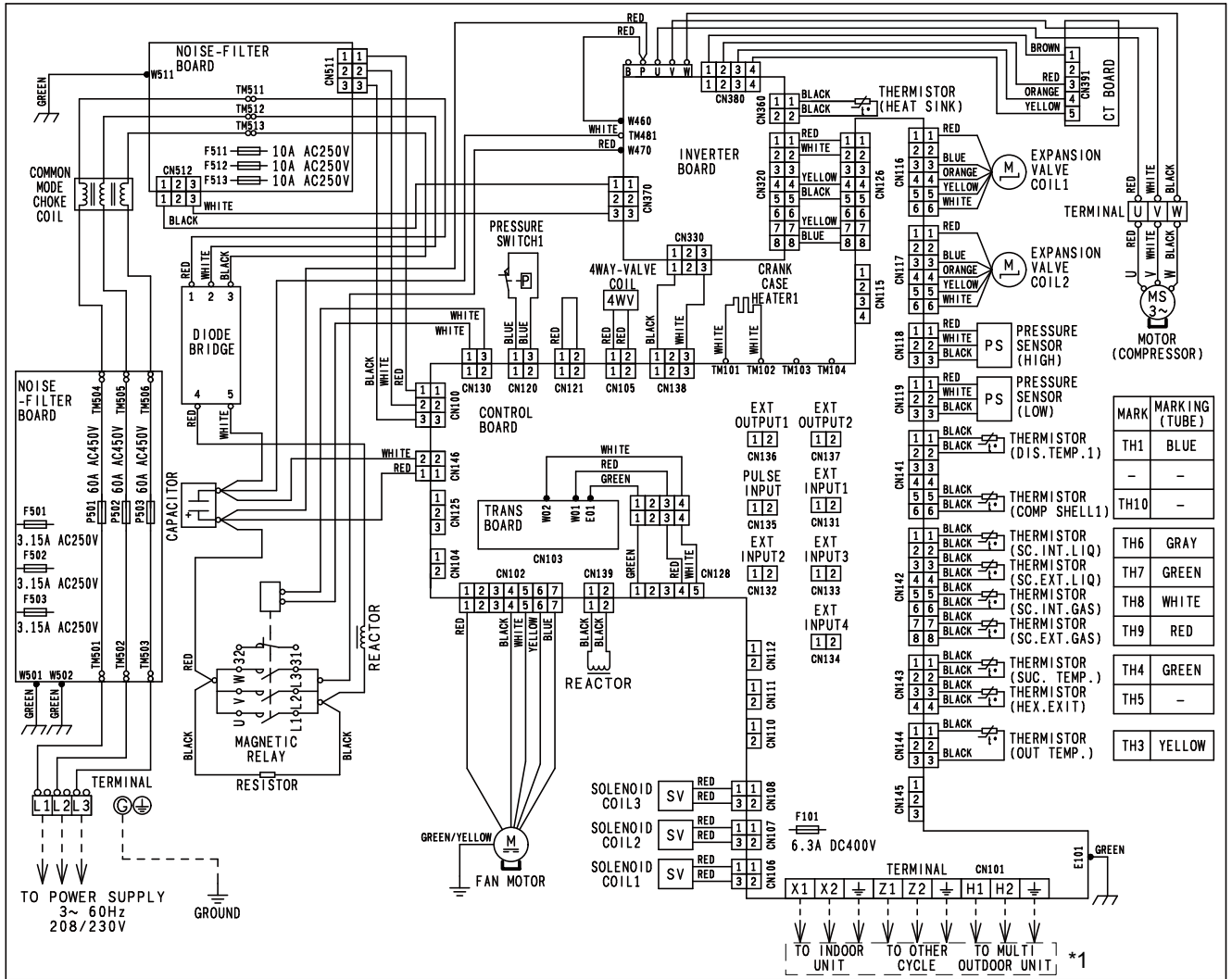

Note : *1

X1, X2 : To be connected to indoor units

Z1, Z2 : To be connected to other master outdoor unit

H1, H2 : To be connected to outdoor unit within same refrigerant system

5-2-3 Outdoor Air Unit

MODELS : AAUA48TLAV

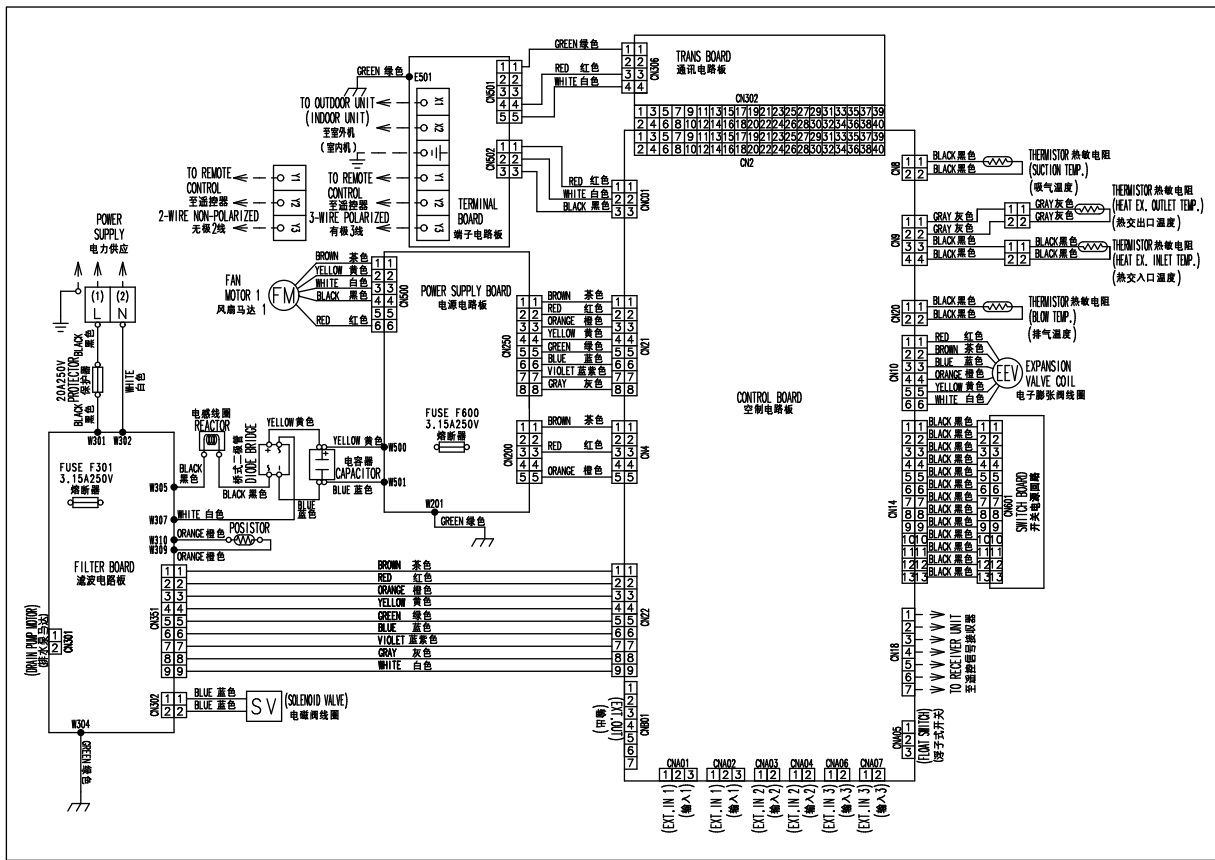

MODELS : AAUA72TLAV

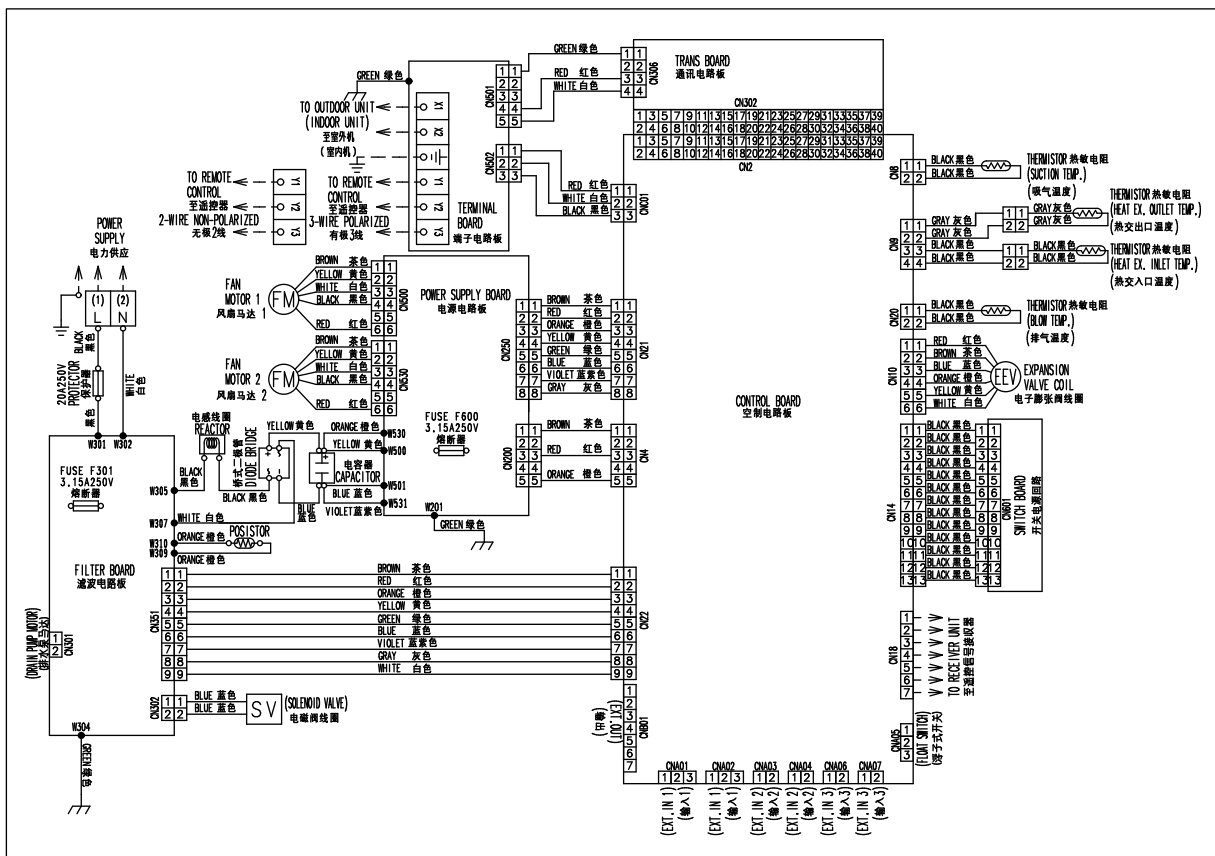

MODELS : AAUA96TLAV

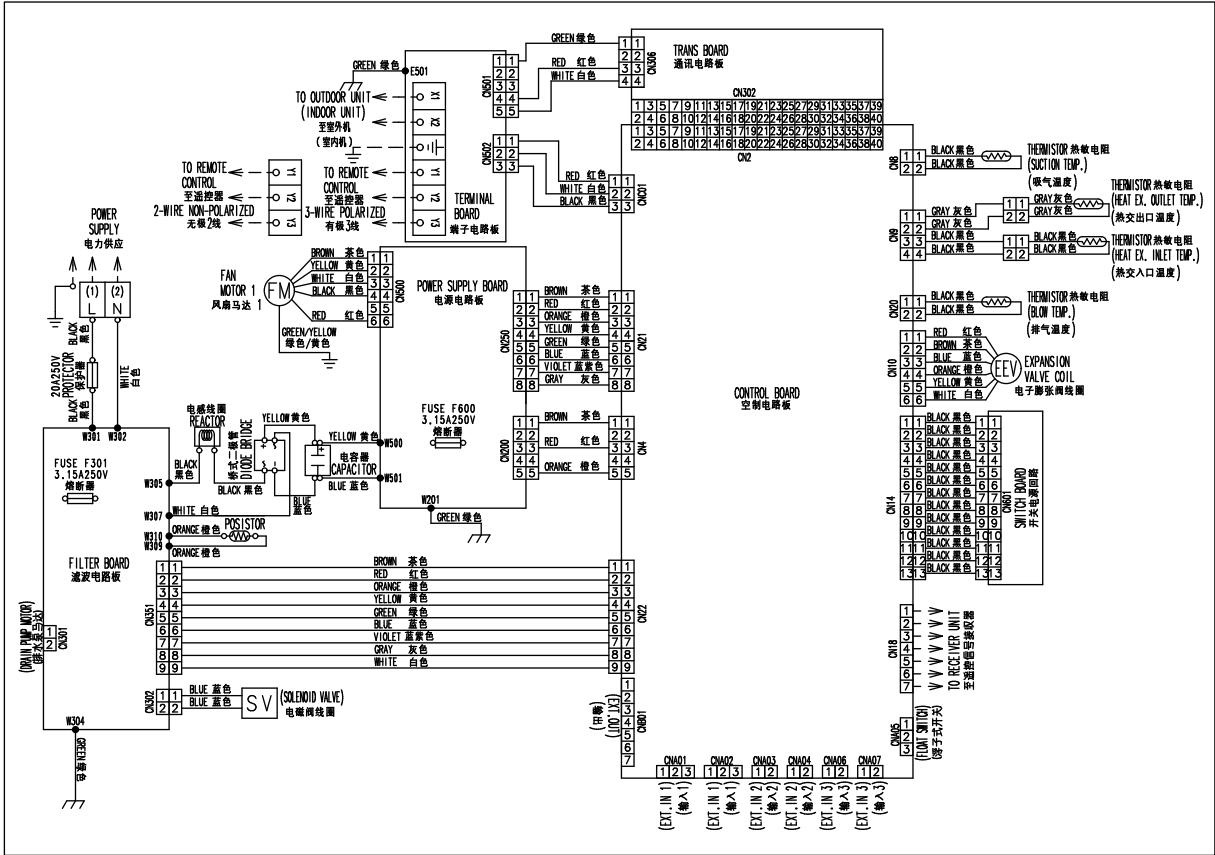

5-2-4 Vertical Air Handler

**MODELS : ARUV12TLAV, ARUV18TLAV, ARUV24TLAV,
ARUV30TLAV, ARUV36TLAV, ARUV48TLAV,
ARUV60TLAV**

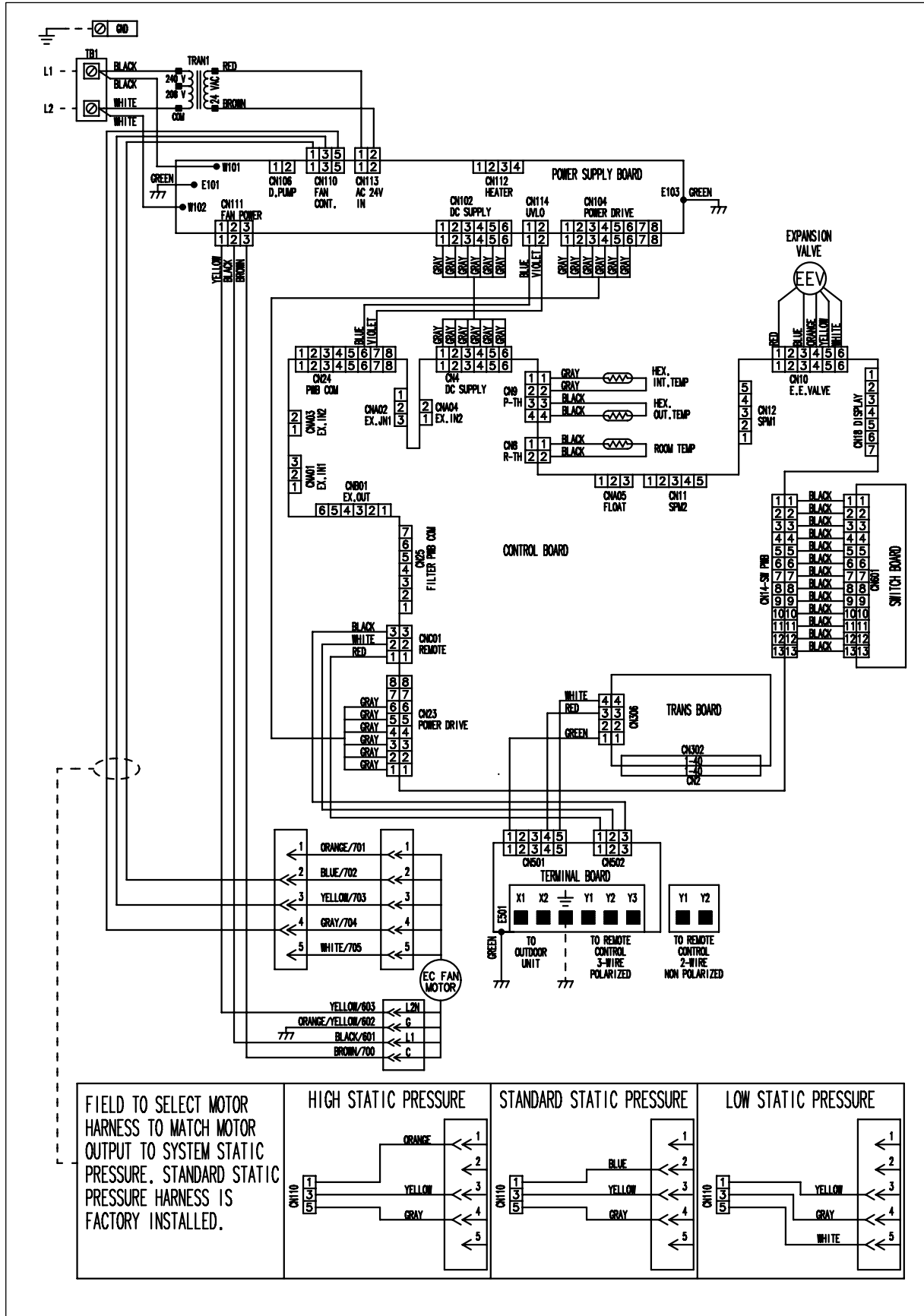

5-3 SATURATION TABLE (R410A)

5-3-1 Saturation temperature and saturation pressure tables (°C / Mpa)

(Pressure: Gauge pressure)

Temp. (°C)	Saturation pressure (Mpa)	
	Saturated liquid	Saturated gas
-30	0.1722	0.1717
-29	0.1836	0.1830
-28	0.1953	0.1947
-27	0.2074	0.2067
-26	0.2199	0.2192
-25	0.2328	0.2320
-24	0.2460	0.2452
-23	0.2597	0.2588
-22	0.2737	0.2728
-21	0.2882	0.2872
-20	0.3031	0.3021
-19	0.3185	0.3174
-18	0.3343	0.3331
-17	0.3505	0.3493
-16	0.3672	0.3659
-15	0.3844	0.3830
-14	0.4021	0.4006
-13	0.4202	0.4187
-12	0.4389	0.4373
-11	0.4580	0.4563
-10	0.4776	0.4759
- 9	0.4978	0.4960
- 8	0.5185	0.5166
- 7	0.5398	0.5377
- 6	0.5616	0.5594
- 5	0.5839	0.5817
- 4	0.6069	0.6045
- 3	0.6304	0.6279
- 2	0.6545	0.6519
- 1	0.6791	0.6765
0	0.7044	0.7017
1	0.7303	0.7274
2	0.7569	0.7539
3	0.7840	0.7809
4	0.8119	0.8086
5	0.8403	0.8369
6	0.8695	0.8659
7	0.9000	0.8956
8	0.930	0.926
9	0.961	0.957
10	0.993	0.989
11	1.026	1.022
12	1.059	1.055
13	1.093	1.089
14	1.128	1.123
15	1.164	1.159
16	1.200	1.195
17	1.237	1.232

Temp. (°C)	Saturation pressure (Mpa)	
	Saturated liquid	Saturated gas
18	1.275	1.270
19	1.314	1.308
20	1.353	1.348
21	1.394	1.388
22	1.435	1.429
23	1.477	1.471
24	1.520	1.513
25	1.563	1.557
26	1.608	1.601
27	1.654	1.647
28	1.700	1.693
29	1.747	1.740
30	1.796	1.788
31	1.845	1.837
32	1.895	1.887
33	1.946	1.938
34	1.998	1.990
35	2.051	2.043
36	2.105	2.097
37	2.160	2.152
38	2.216	2.208
39	2.273	2.265
40	2.332	2.323
41	2.391	2.382
42	2.451	2.442
43	2.513	2.503
44	2.575	2.565
45	2.639	2.629
46	2.703	2.693
47	2.769	2.759
48	2.836	2.826
49	2.904	2.894
50	2.974	2.963
51	3.044	3.034
52	3.116	3.106
53	3.189	3.178
54	3.263	3.253
55	3.338	3.328
56	3.415	3.405
57	3.493	3.483
58	3.572	3.562
59	3.653	3.643
60	3.735	3.725
61	3.818	3.808
62	3.902	3.893
63	3.988	3.979
64	4.075	4.066
65	4.164	4.155

Saturation pressure (Mpa)	Saturation temperature (°C)	
	Saturated liquid	Saturated gas
0.0	-51.85	-51.83
0.1	-37.25	-37.21
0.2	-27.61	-27.55
0.3	-20.21	-20.14
0.4	-14.12	-14.04
0.5	- 8.89	- 8.80
0.6	- 4.30	- 4.20
0.7	- 0.17	- 0.06
0.8	3.58	3.69
0.9	7.02	7.15
1.0	10.22	10.35
1.1	13.21	13.34
1.2	16.01	16.15
1.3	18.66	18.80
1.4	21.17	21.31
1.5	23.55	23.70
1.6	25.83	25.98
1.7	28.01	28.16
1.8	30.10	30.25
1.9	32.11	32.26
2.0	34.04	34.20
2.1	35.91	36.06
2.2	37.72	37.87
2.3	39.46	39.62
2.4	41.16	41.31
2.5	42.80	42.95
2.6	44.40	44.55
2.7	45.95	46.10
2.8	47.47	47.62
2.9	48.94	49.09
3.0	50.38	50.53
3.1	51.78	51.93
3.2	53.16	53.30
3.3	54.50	54.63
3.4	55.81	55.94
3.5	57.09	57.22
3.6	58.35	58.48
3.7	59.58	59.70
3.8	60.79	60.91
3.9	61.98	62.09
4.0	63.14	63.25
4.1	63.99	64.38

5-3-2 Saturation temperature and saturation pressure tables (°F / PSI)

(Pressure: Gauge pressure)

Temp. (°F)	Saturation pressure (PSI)	
	Saturated liquid	Saturated gas
-22	24.969	24.897
-20	26.622	26.535
-18	28.319	28.232
-17	30.073	29.972
-15	31.886	31.784
-13	33.756	33.640
-11	35.670	35.554
-9	37.657	37.526
-8	39.687	39.556
-6	41.789	41.644
-4	43.950	43.805
-2	46.183	46.023
-0.3	48.474	48.300
1	50.823	50.649
3	53.244	53.056
5	55.738	55.535
7	58.305	58.087
9	60.929	60.712
10	63.641	63.409
12	66.410	66.164
14	69.252	69.006
16	72.181	71.920
18	75.183	74.907
19	78.271	77.967
21	81.432	81.113
23	84.666	84.347
25	88.001	87.653
27	91.408	91.046
28	94.903	94.526
30	98.470	98.093
32	102.15	101.75
34	105.90	105.47
36	109.75	109.32
37	113.68	113.23
39	117.73	117.25
41	121.84	121.35
43	126.08	125.56
45	130.50	129.86
46	134.85	134.27
48	139.35	138.77
50	143.99	143.41
52	148.77	148.19
54	153.56	152.98
55	158.49	157.91
57	163.56	162.84
59	168.78	168.06
61	174.00	173.28
63	179.37	178.64

Temp. (°F)	Saturation pressure (PSI)	
	Saturated liquid	Saturated gas
64	184.88	184.15
66	190.53	189.66
68	196.19	195.46
70	202.13	201.26
72	208.08	207.21
73	214.17	213.30
75	220.40	219.39
77	226.64	225.77
79	233.16	232.15
81	239.83	238.82
82	246.50	245.49
84	253.32	252.30
86	260.42	259.26
88	267.53	266.37
90	274.78	273.62
91	282.17	281.01
93	289.71	288.55
95	297.40	296.24
97	305.23	304.07
99	313.20	312.04
100	321.32	320.16
102	329.59	328.43
104	338.14	336.84
106	346.70	345.39
108	355.40	354.09
109	364.39	362.94
111	373.38	371.94
113	382.66	381.21
115	391.94	390.49
117	401.51	400.06
118	411.22	409.77
120	421.08	419.63
122	431.23	429.64
124	441.38	439.93
126	451.82	450.37
127	462.41	460.81
129	473.14	471.69
131	484.01	482.56
133	495.18	493.73
135	506.49	505.04
136	517.94	516.49
138	529.69	528.24
140	541.58	540.13
142	553.61	552.16
144	565.79	564.49
145	578.26	576.96
147	590.88	589.57
149	603.78	602.48

Saturation pressure (PSI)	Saturation temperature (°F)	
	Saturated liquid	Saturated gas
0.0	-61.33	-61.29
14.5	-35.05	-34.98
29.0	-17.70	-17.59
43.5	-4.38	-4.25
58.0	6.58	6.73
72.5	16.00	16.16
87.0	24.26	24.44
101.5	31.69	31.89
116.0	38.44	38.64
130.5	44.64	44.87
145.0	50.40	50.63
159.5	55.78	56.01
174.0	60.82	61.07
188.5	65.59	65.84
203.0	70.11	70.36
217.5	74.39	74.66
232.0	78.49	78.76
246.5	82.42	82.69
261.0	86.18	86.45
275.5	89.80	90.07
290.0	93.27	93.56
304.5	96.64	96.90
319.0	99.90	100.17
333.5	103.03	103.32
348.0	106.08	106.36
362.5	109.04	109.31
377.0	111.92	112.19
391.5	114.71	114.98
406.0	117.45	117.72
420.5	120.09	120.36
435.0	122.68	122.95
449.5	125.20	125.47
464.0	127.69	127.94
478.5	130.10	130.33
493.0	132.46	132.69
507.5	134.76	135.00
522.0	137.03	137.26
536.5	139.24	139.46
551.0	141.42	141.64
565.5	143.56	143.76
580.0	145.65	145.85
594.5	147.18	147.88

5-3-3 Temperature and pressure of refrigerant (Graph)

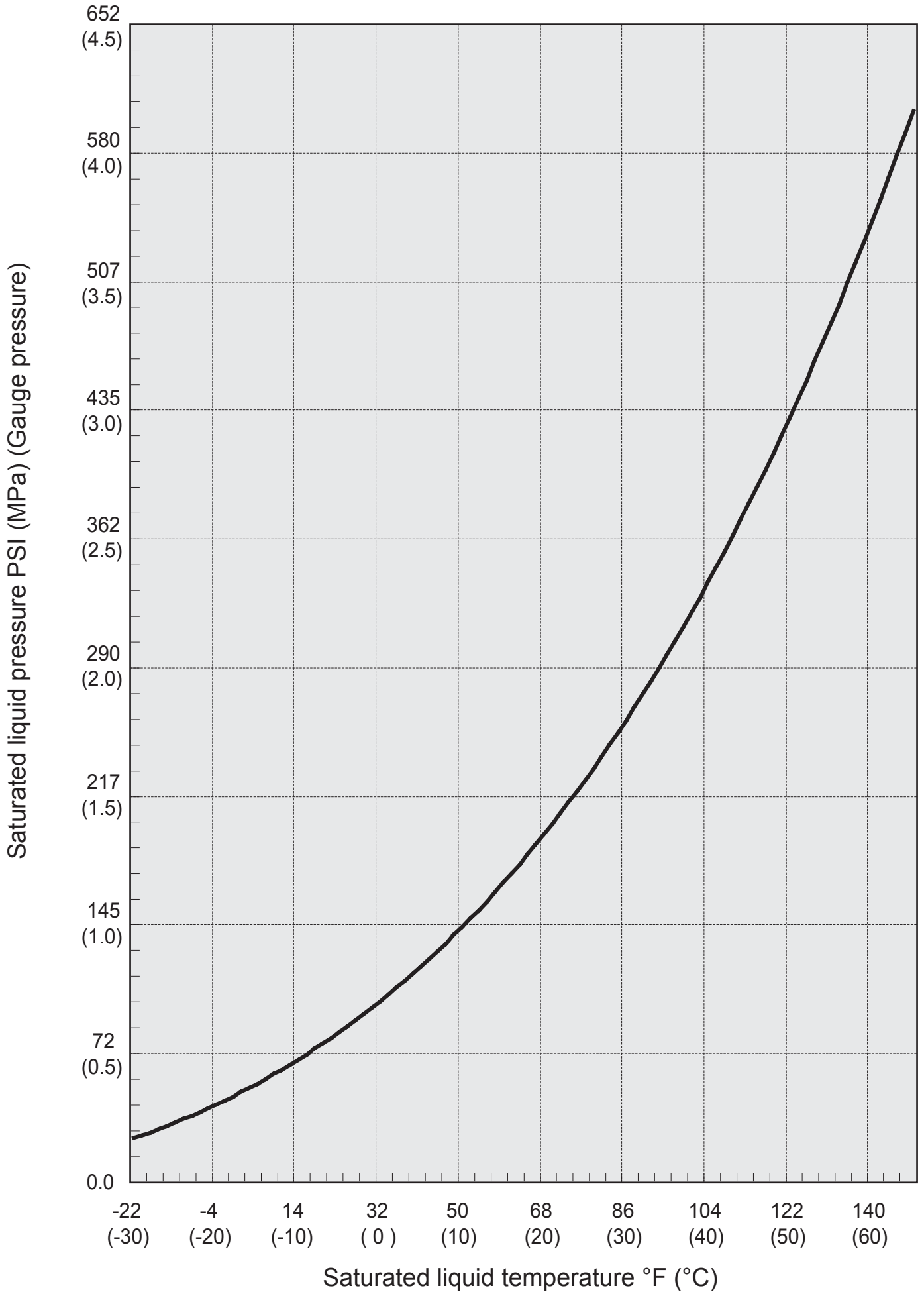

AIRSTAGE™ V-II

Variable Refrigerant Flow System

6. DISASSEMBLY PROCESS

6. DISASSEMBLY PROCESS

⚠ WARNING

Before servicing the unit, turn the power supply switch OFF,
Then, do not touch electric parts for 10 minutes due to the risk of electric shock.

1. Appearance



Model : AOUA72 / 96RLBV

2. PANEL TOP removal



screws

Remove the 4 mounting screws.

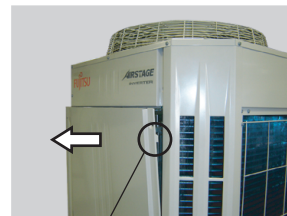
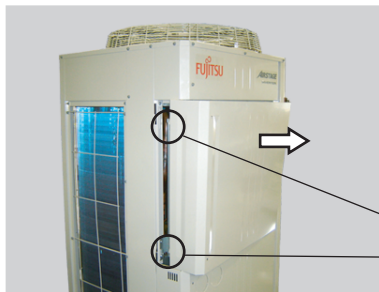

Hook (3 places)

Remove the PANEL TOP
by sliding toward.

3. CONTROL BOX COVER removal



screws

Remove the 4 mounting screws.

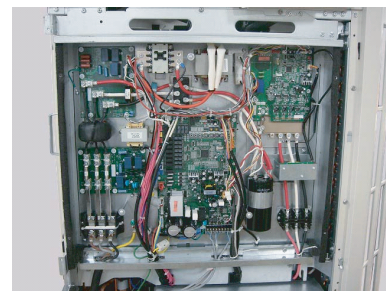
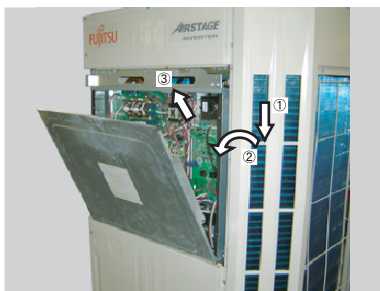

Remove the CONTROL BOX COVER
by sliding downward.

4. Layout plan in CONTROL BOX

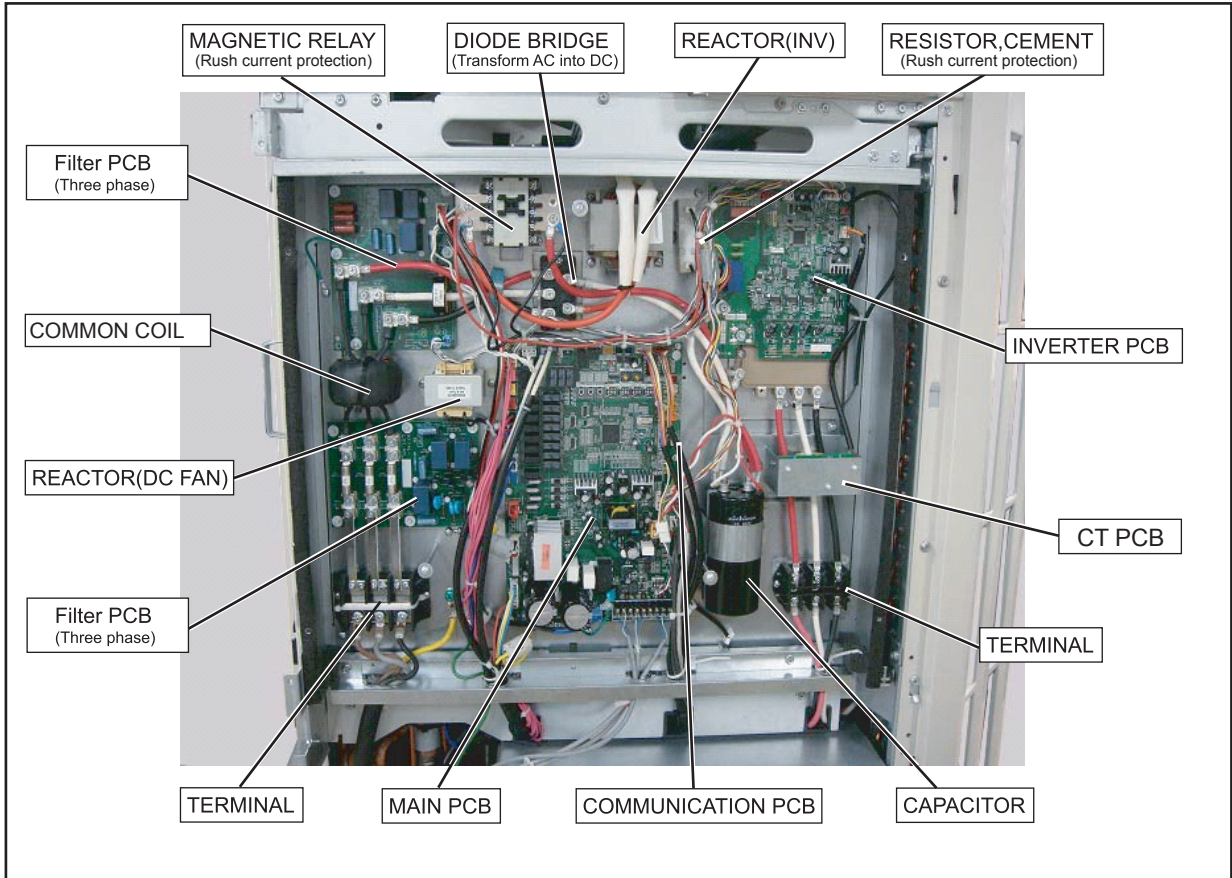

5. Screw tightening torque

If removed the Magnetic relay, Please tightening with the regulated torque.

Mounting the Bus bar B.

Mounting the Wire.

● $2.4 \pm 0.1 \text{ N} \cdot \text{m} (21.3 \pm 0.9 \text{ lbf} \cdot \text{in})$
 □ $0.5 \text{ to } 0.6 \text{ N} \cdot \text{m} (4.4 \text{ to } 5.3 \text{ lbf} \cdot \text{in})$

● $1.5 \pm 0.1 \text{ N} \cdot \text{m} (13.3 \pm 0.9 \text{ lbf} \cdot \text{in})$
● $1.0 \pm 0.1 \text{ N} \cdot \text{m} (8.9 \pm 0.9 \text{ lbf} \cdot \text{in})$
● $5.0 \text{ to } 7.0 \text{ N} \cdot \text{m} (44.3 \text{ to } 62.0 \text{ lbf} \cdot \text{in})$

⚠ DANGER

There is danger to which a fire and the capacitor explosion break out in the market if it does not assemble it with a regulated torque.

6. MAIN PCB removal

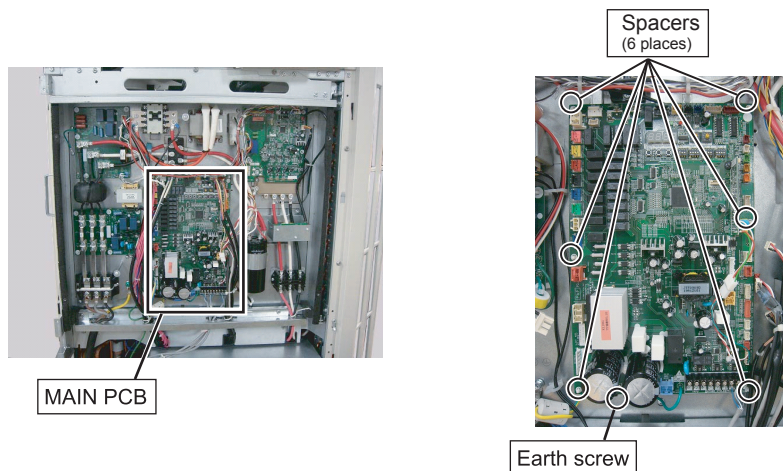

Remove the connectors and earth screw.
Remove the spacers.

⚠ CAUTION

The model name is written in MAIN PCB of the outdoor unit and indoor unit, and when the factory of the product is shipped, it is written. However, the model name is not written in the MAIN PCB supplied for the repair. When the following function is made to work, the written model name is needed.

1. Display of system list display in service tool or system controller
2. Display of refrigerant circuit diagram in service tool.
3. When you use the electricity charge calculation function as system controller or touch panel controller.

If the model name is not written, the trouble such as the refrigerant circuit diagram is not displayed or the electricity charge calculation is not done accurately might occur.

Therefore, please register the model name to each controller who uses it when you exchange MAIN PCB by the repair.

1. Model name registration to service tool

Please register the model name with the system list template files.
An arbitrary model name can be written to the target unit.

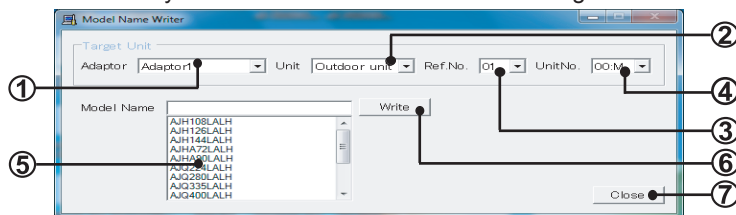

- ① Adaptor selection
Selects the transmission adaptor which connects the target unit.
- ② Unit selection
Selects the type of unit (indoor unit/outdoor unit).
- ③ Refrigerant circuit address selection
Selects the target refrigerant circuit address.
- ④ Unit address selection
Selects the target unit address.
- ⑤ Model name selection
Selects the write model name.
Advanced search is also possible by directly inputting the model name.
- ⑥ Write button
Executes writing of the specified model name to the target unit
- ⑦ Close button
Closes this screen.

2. Model name registration to system controller

Please register the model name by the electricity charge calculation setting.
(Please see the operation manual of system controller for details)

7. INVERTER PCB removal

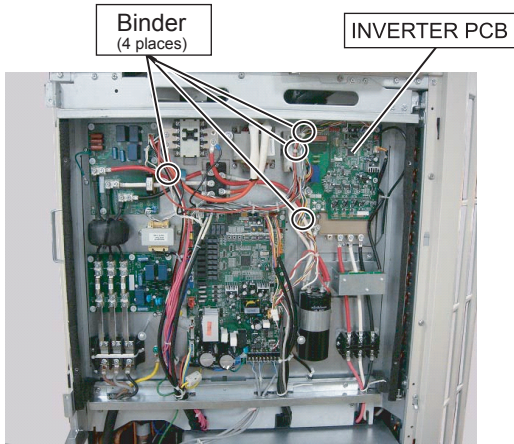

Cut the binder of 4 places.

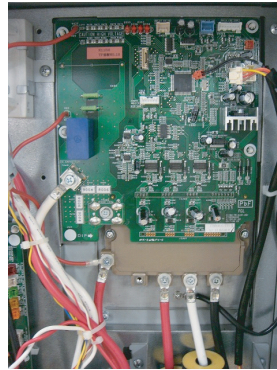

Remove the connectors.

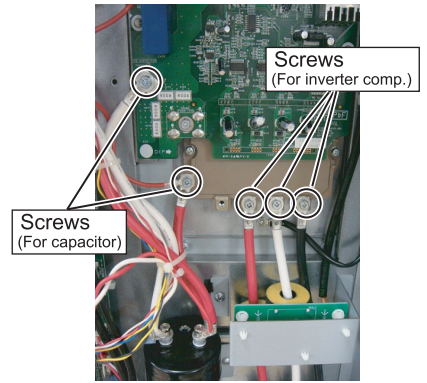

Remove the 5 mounting screws and codes.

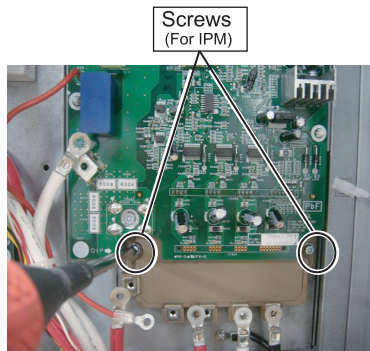

Remove the 2 mounting screws of IPM.

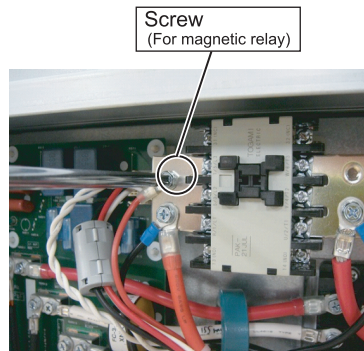

Remove the mounting screw and code.

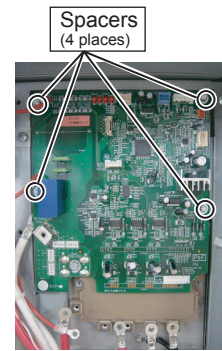

Remove the connectors and spacers.



IPM

Spread the heat dissipation compound on the other side of IPM when you exchange INVERTER PCB by the repair.

COMPOUND

Parts Name	Service Parts No.
HEAT SINKER(20g)	0000036795

8. PANEL BTM removal

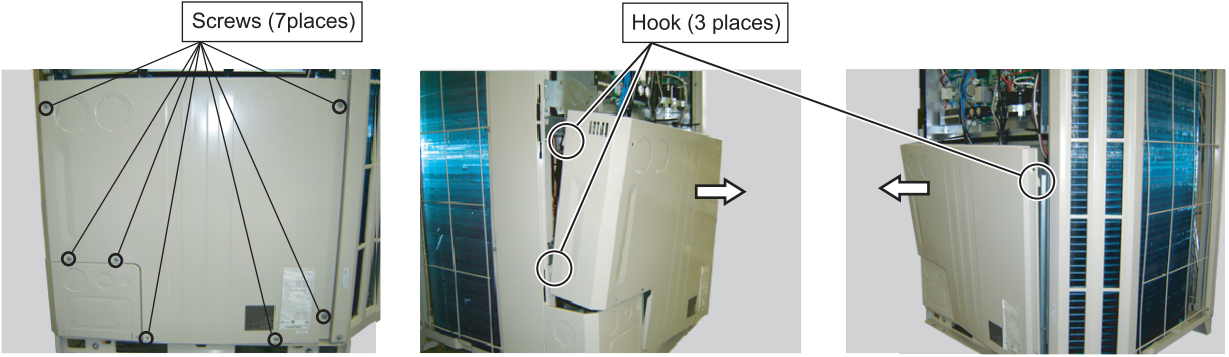

Screws (7places)

Hook (3 places)

Remove the 7 mounting screws.

Remove the PANEL BTM by sliding toward.

9. CONDUIT PLATE removal

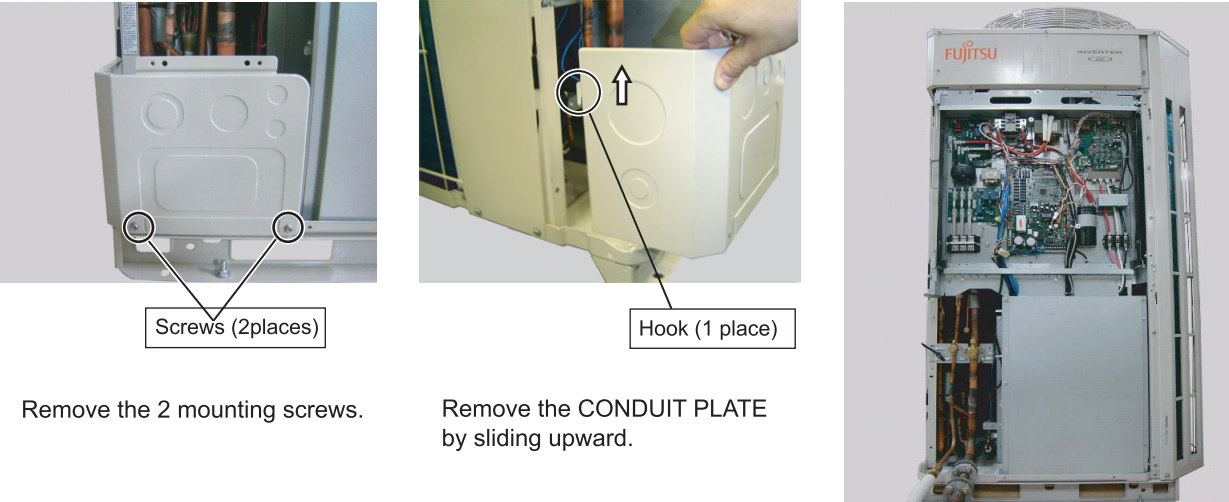

Screws (2places)

Hook (1 place)

Remove the 2 mounting screws.

Remove the CONDUIT PLATE by sliding upward.

10. CONTROL BOX open

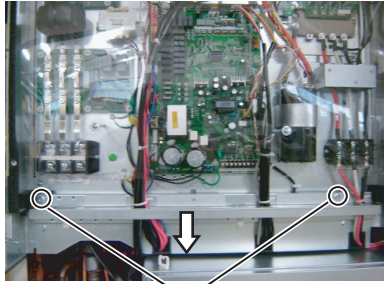

Screws (2places)

Remove the 2 mounting screws.

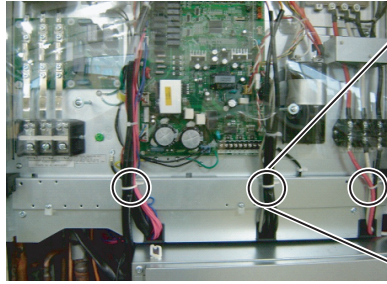

locking binders.(3 places)

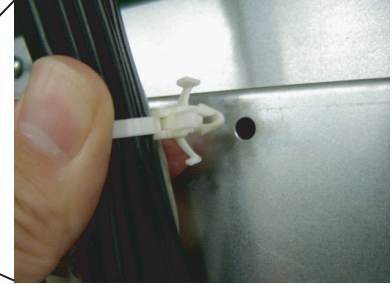

Remove the locking binders.(3 places)
Do not cut the binder.

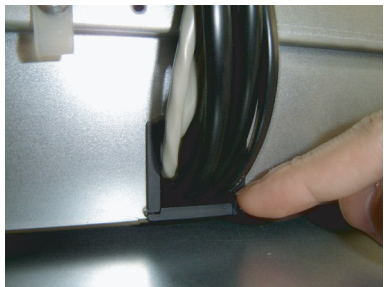

Remove the locking stopper
of edging saddle.(3 places)



Remove the wires from edging saddle.
(3 places)

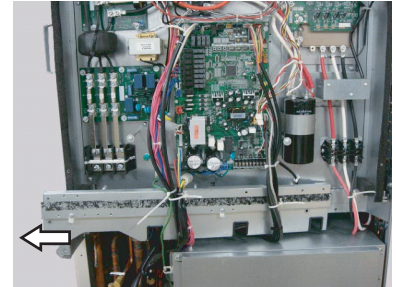

Remove the WIRE PLATE
by sliding leftward.

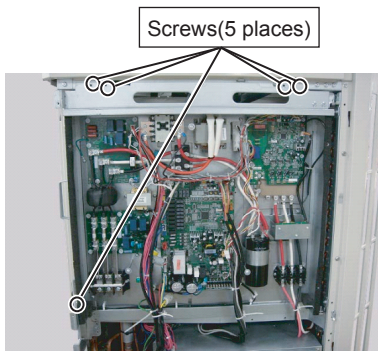

Screws(5 places)

Remove the 5 mounting screws.

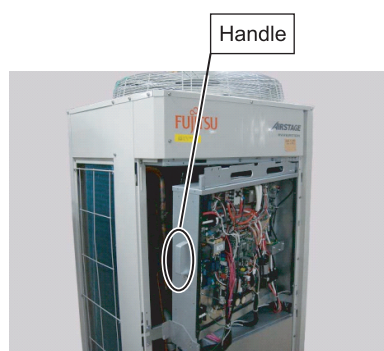

Handle

Open the CONTROL BOX with handle.

11. THERMISTORS removal

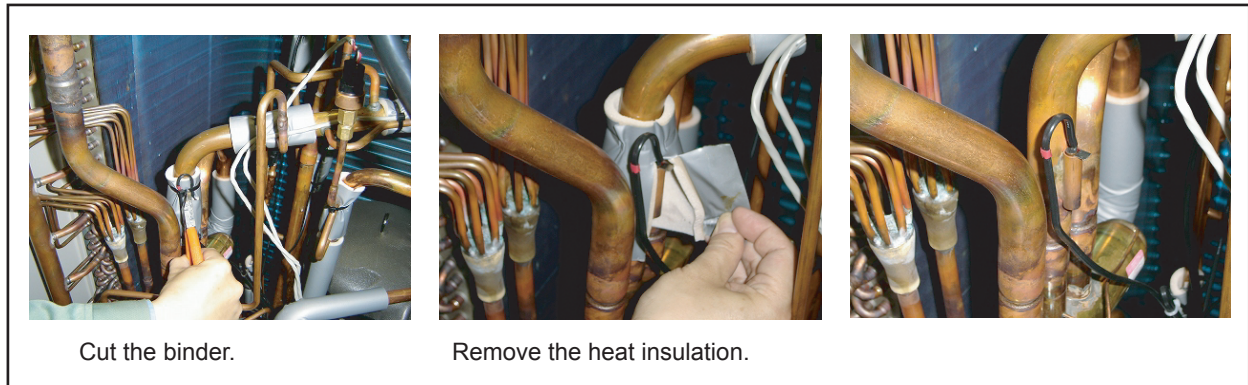

12. SOLENOID COILS (4way valve and Solenoid valves) removal

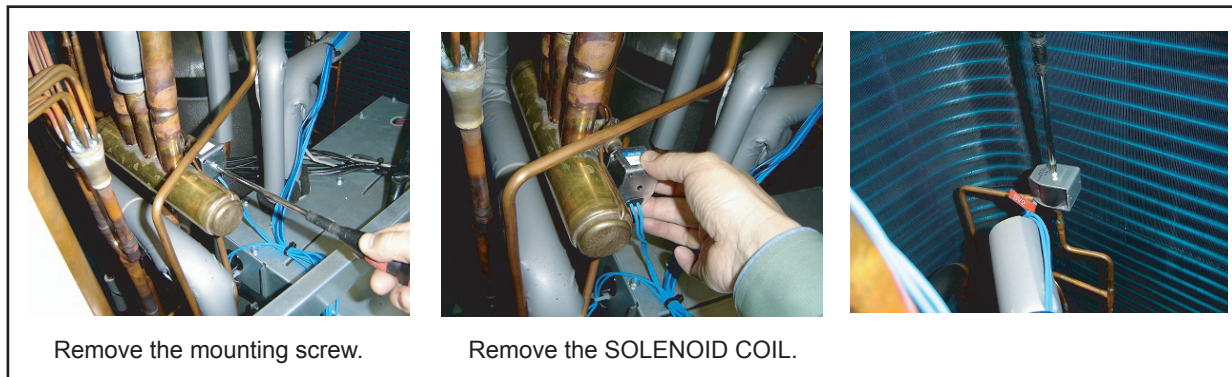

13. EEV COILS removal

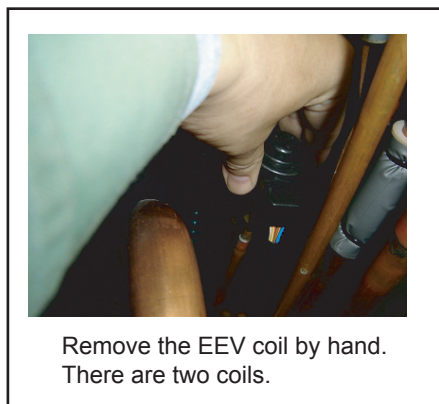

14. PRESSURE SENSORS removal

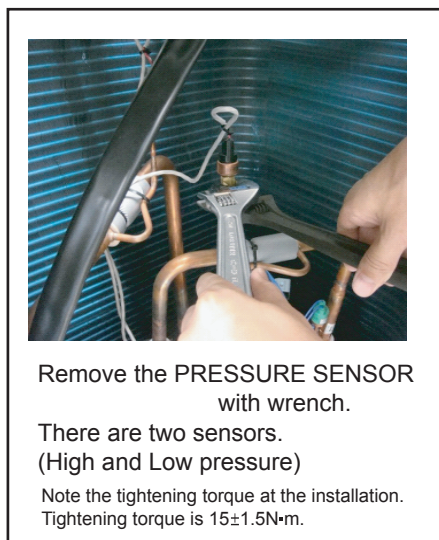

15. FAN MOTOR removal

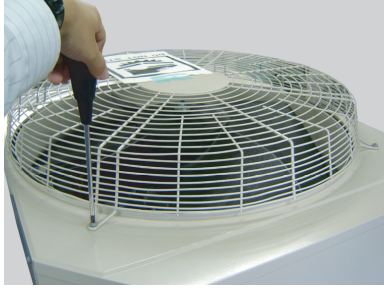

Remove the 4 mounting screws.

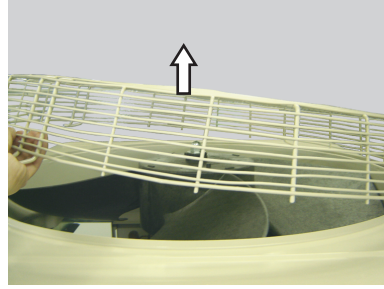

Remove the FAN GUARD.



Remove the nut.

Note the tightening torque at the installation.
Tightening torque is from 15 to 20N·m.

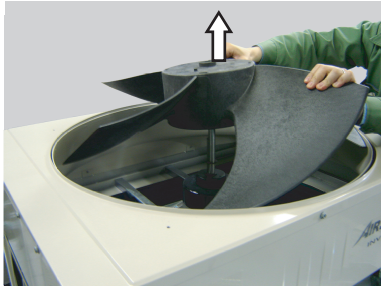

Remove the PROPELLER FAN.

Note at the installation.
Insert propeller Fan and Moter shaft reference
D cutting position.

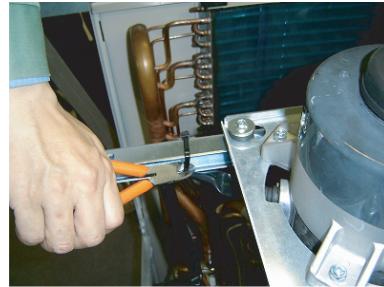

Cut the binder.

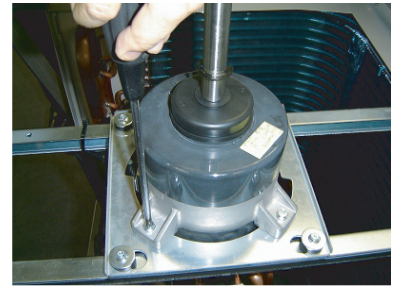

Remove the 4 mounting screws.
Remove the FAN MOTOR.

16. COMP BOX COVER removal

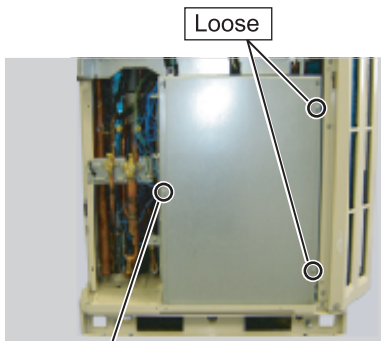

Loose the 2 mounting screws.
Remove the a mounting screw.

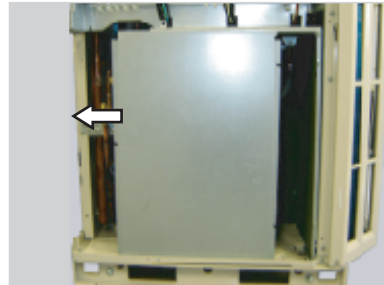

Remove the COMP BOX COVER
by sliding leftward.



17. COMPRESSOR removal

Precautions for exchange of Compressor.

Do not allow moisture or debris to get inside refrigerant pipes during work.

Procedure for compressor removal.

- (1) Turn off power.
- (2) Remove the PANEL TOP and PANEL BTM.
- (3) Fully close the 3WAY VALVE(GAS) and 3WAY VALVE(LIQUID).
- (4) Collect the refrigerant from the service port.
Start the following work after completely collecting the refrigerant.
Do not reuse the refrigerant that has been collected.

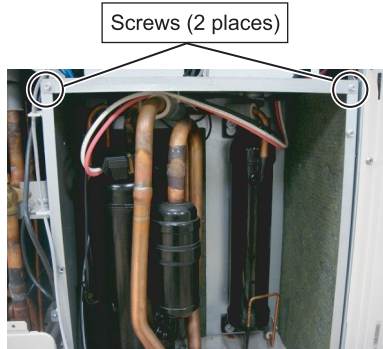

Remove the 2 mounting screws.
Remove the wires.

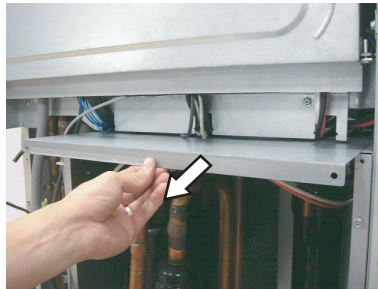

Remove the COMP BOX TOP
by sliding toward.

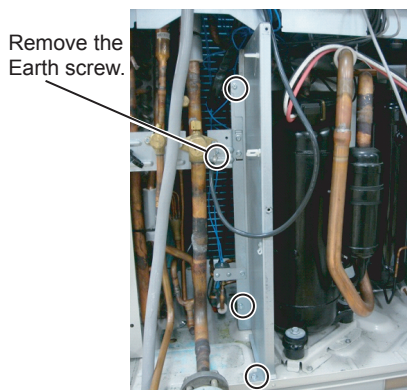

Remove the
3 mounting screws.

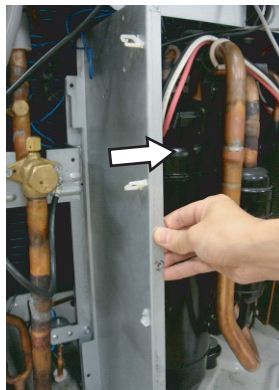

Remove the COMP BOX L
by sliding toward.

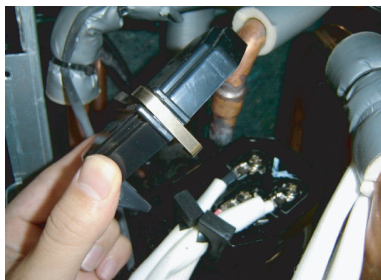

Remove the TERMINAL COVER.



Remove the 3 mounting screws
of TERMINAL.
[U : RED, W : BLACK, V : WHITE]

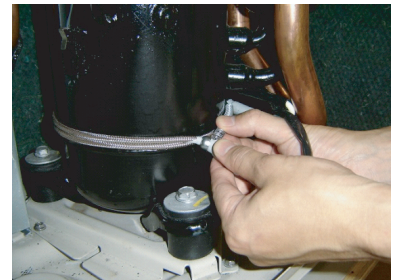

Remove the CRANK CASE HEATER.

Thermistor (Discharge)



Heat insulation

Thermistor (comp. temp.)

Remove the Thermistor (comp.temp.)
and Thermistor (Discharge).
Remove the heat insulations.



Remove the COMP BOLTS.
(3 places)

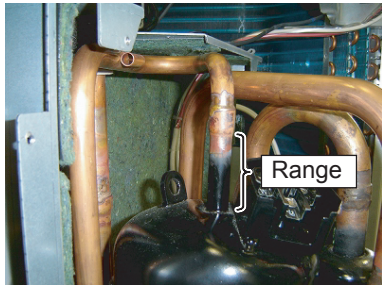

Cut the Discharge pipe in this range.

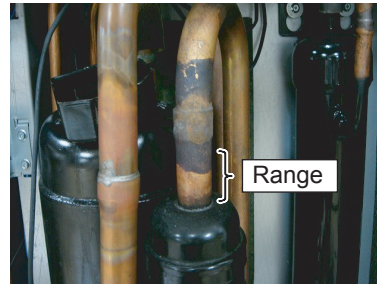

Cut the Suction pipe in this range.
Remove the COMPRESSOR.

Caution

- Keep their shape better.
- There is a possibility of catching fire to oil when removing by the welding without cutting it.

Procedure for compressor installation.

Reverse procedure to removing the compressor.

Precautions for installation of Compressor.

- (1) When brazing, do not apply the flame to the terminal.
- (2) When brazing, be sure to replace the air in the pipe with nitrogen gas to prevent forming oxidization scale.

18. Precautions for exchange of Pressure Port B Assy

Pressure port B assy includes a " Fusible plug ". Be aware of the followings when repairing.

1. Fusible plug



Plug made of fusible alloy.

When a temperature inside equipment extremely rises by fire disaster, fusible alloy of plug will melt and make a hole.

And refrigerant inside equipment will be discharged

for preventing a burst of pressure vessel coming from pressure increase.

2. Location of Fusible plug



<Precautions>

(1) When a temperature reaches to 167 degrees F (75 degrees C), fusible alloy in the center of plug will melt and make a hole.

(2) When you replace a fusible plug, make sure to replace "Pressure port B assy" extensively.

(RefNo.116 P/N 9378963047)

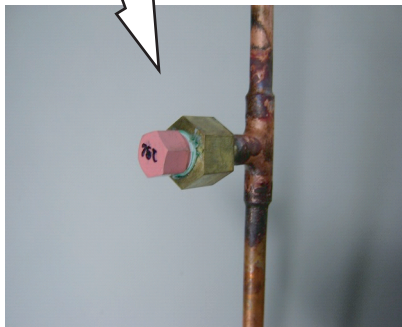
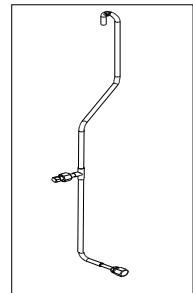

(3) When you replace a "Pressure port B assy", make sure to drape a wet rag on it for keeping it cool.

If fusible alloy melts and makes a hole from heat, vacuum drawing and refrigerant charging will be not available. Also refrigerant inside will be discharged swiftly.

(4) When you weld pipes or parts near fusible plug, make sure to insulate plug and pipes from fire and guard a plug using a wet rag.

(5) Do not unclench a fusible plug. Airtightness will be compromised. If a plug is unclenched (In order to keep high airtightness, it is controlled strictly by tightening torque, seal tape and Loctite.)

19. Precautions for when replacing refrigerant-cycle-parts

- (1) During replacement of the following parts shall be protected by wet rag and not make the allowable temperature or more.
- (2) Remove the heat insulation when there is the heat insulation near the welding place.
Move and cool it when its detaching is difficult.
- (3) Cool the parts when there are parts where heat might be transmitted besides the replacement part.
- (4) Interrupt the flame with the fire-retardant board when the flame seems to hit the following parts directly.
- (5) Do not allow moisture or debris to get inside refrigerant pipes during work.
- (6) When brazing, be sure to replace the air in the pipe with nitrogen gas to prevent forming oxidization scale.

Part name	Allowable temperature	Precautions in work	Applicable Outdoor unit (TON)	
			6	8
SOLENOID VALVE 1 /2 /3	392°F (200°C)	Remove the coil before brazing. And install the coil after brazing.	○	
EXPANSION VALVE 1 /2	248°F (120°C)	Remove the coil before brazing. And install the coil after brazing.	○	
4WAY VALVE		Remove the suction temp. sensor before brazing. And install the suction temp. sensor after brazing.	○	
CHECK VALVE			○	
RELIEF VALVE			○	
3WAY VALVE (GAS)			○	
3WAY VALVE (LIQUID)	212°F (100°C)		○	
UNION JOINT		Remove the pressure sensor before brazing. And install the pressure sensor after brazing.	○	
HIGH PRESSURE SENSOR		Tighten the flare part gripping it. Tightening torque :15±1.5N·m(11±1.1lbf·ft)	○	
LOW PRESSURE SENSOR		Do the static electricity measures.	○	
PRESSURE SWITCH			○	
FUSIBLE PLUG	167°F (75°C)	Make sure to drape a wet rag on it for keeping fusible plug cool.	○	

AIRSTAGE™ V-II

Variable Refrigerant Flow System



"**AIRSTAGE**"™ is a worldwide trademark of FUJITSU GENERAL LIMITED.

* Microsoft® and Windows® are registered trademarks of Microsoft Corporation in United States.

* Adobe® and Acrobat Reader® are registered trademarks of Adobe Systems Incorporated in the United States.

* Intel® ,Pentium® and Celeron® are registered trademarks of Intel Corporation or its subsidiaries in the United States.

* AMD Athlon™ and AMD Duron™ are registered trademarks of Advanced Micro Devices, Inc.

* Echelon®, LONWORKS®, and the Echelon logo are trademarks of Echelon Corporation registered in the United States and other countries.

* BACnet® is a registered trademark of the American Society of Heating Refrigeration and Air Conditioning Engineers (ASHRAE).

Copyright© 2012 Fujitsu General Limited. All rights reserved.

Product specifications are subject to change without notice.