

**PRODUCT SPECIFICATIONS**

Elkay Stainless Steel 16-3/4" x 15-1/2" x 13" Single Bowl Wall Hung Handwash Sink Kit. Sink is manufactured from 20 gauge 304 Stainless Steel with a Buffed Satin finish, Center drain placement.

<b>Material:</b>	304 Stainless Steel
<b>Finish:</b>	Buffed Satin
<b>Gauge:</b>	20
<b>Number of Bowls:</b>	1
<b>Sink Dimensions:</b>	16-3/4" x 15-1/2" x 13"
<b>Bowl 1 Dimensions:</b>	12" x 9-1/4" x 6"
<b>Drain Size:</b>	2" (51mm)
<b>Drain Location:</b>	Center



**Included with Product:** CHS1716 sink,  
one LKB722C sensor faucet with AC  
plug-in / 4 AA batteries,  
one LK8 drain fitting,  
one LK500 P-trap

▼ **Ships in multiple boxes.**

A Century of Tradition and Quality.  
For more than 100 years, Elkay has been making innovative products and providing exceptional customer care. We take pride in offering plumbing products that make life easier, inspire change and leave the world a better place.



**Product Compliance:** ASME A112.19.3/CSA B45.4  
NSF 2  
Faucet: ASME A112.18.1/CSA B125.1  
CEC  
NSF 372 (lead free)  
NSF 61  
Accessory: ASME A112.18.2/CSA B125.2



[Clean and Care Manual \(PDF\)](#)  
[Installation Instructions \(PDF\) - 74180184](#)  
[Installation Instructions \(PDF\) - 98517C](#)  
[Installation Instructions \(PDF\) - 100005235 drain](#)  
[Warranty \(PDF\)](#)

PART: \_\_\_\_\_ QTY: \_\_\_\_\_  
PROJECT: \_\_\_\_\_  
CONTACT: \_\_\_\_\_  
DATE: \_\_\_\_\_  
NOTES: \_\_\_\_\_  
APPROVAL: \_\_\_\_\_

*In keeping with our policy of continuing product improvement, Elkay reserves the right to change product specifications without notice. Please visit [elkay.com](http://elkay.com) for the most current version of Elkay product specification sheets. This specification describes an Elkay product with design, quality, and functional benefits to the user. When making a comparison of other producers' offerings, be certain these features are not overlooked.*

Included Accessories		
<a href="#">LK500</a>	Elkay P-Trap with Cleanout Plug <a href="#">Spec Sheet (PDF)</a>	
<a href="#">LK8</a>	Elkay 2" Drain Fitting Type 304 Stainless Steel Body Grid Strainer and Tailpiece <a href="#">Spec Sheet (PDF)</a>	
<a href="#">LKB722C</a>	Elkay Commercial Electronic Sensor Scrub/Handwash Battery Powered Wall Mount Faucet Chrome <a href="#">Spec Sheet (PDF)</a>	

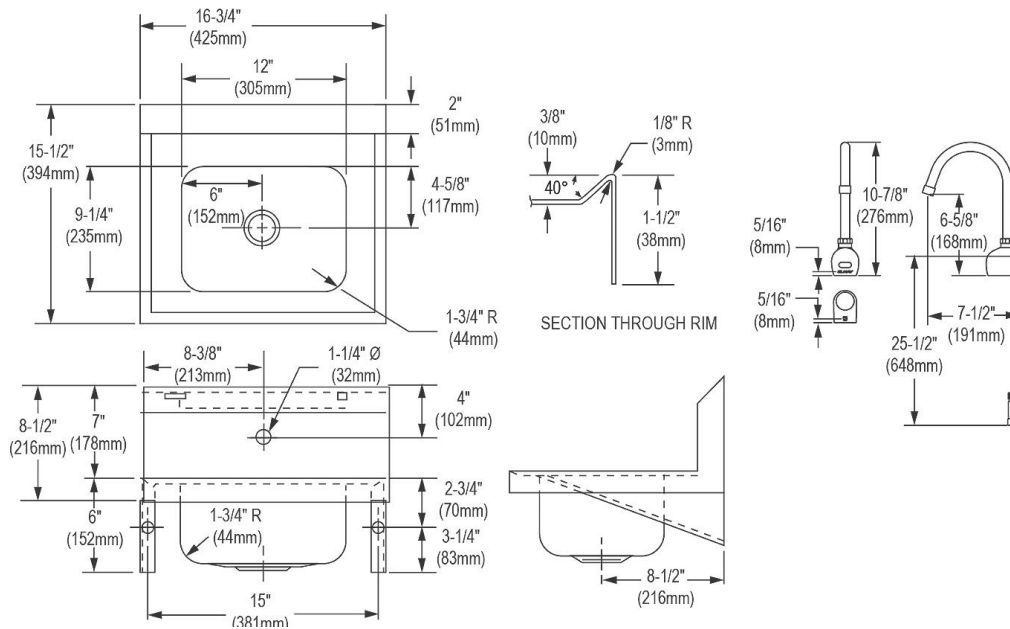

In keeping with our policy of continuing product improvement, Elkay reserves the right to change product specifications without notice. Please visit [elkay.com](http://elkay.com) for the most current version of Elkay product specification sheets. This specification describes an Elkay product with design, quality, and functional benefits to the user. When making a comparison of other producers' offerings, be certain these features are not overlooked.

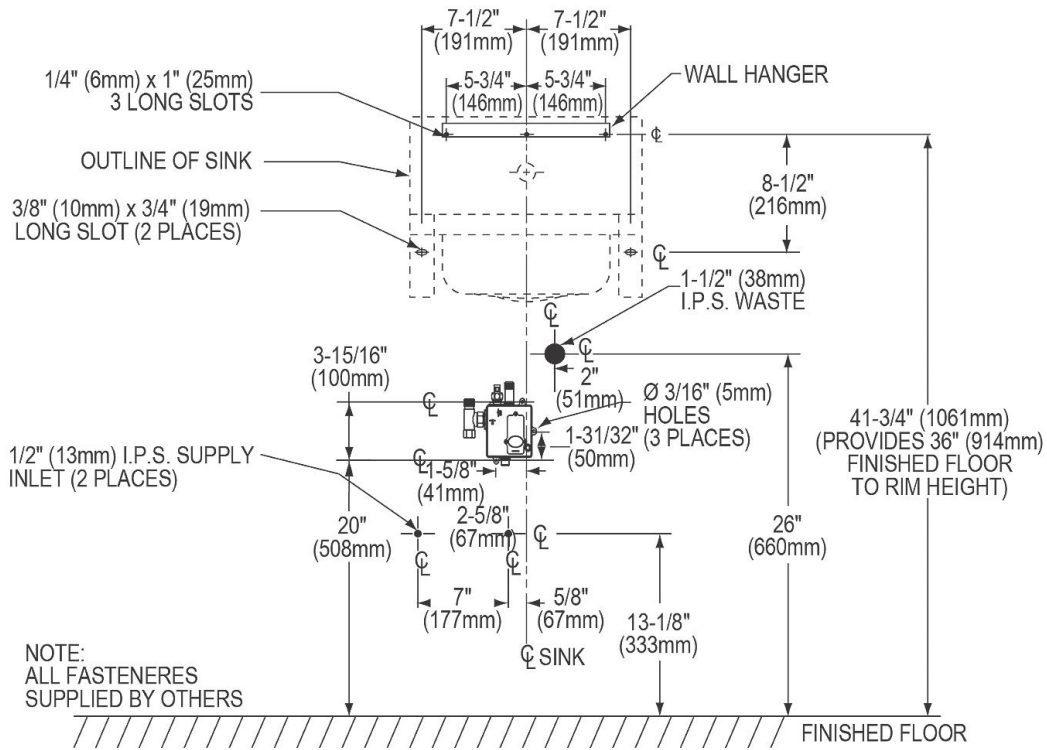

FOR CHS1716SSACMC

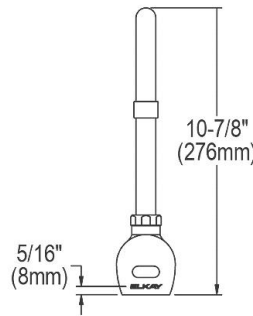
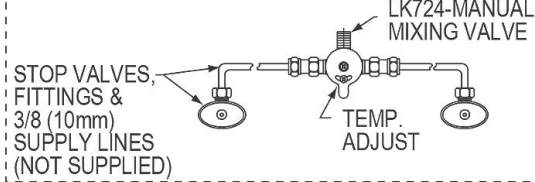

FOR CHS1716SSACTMC

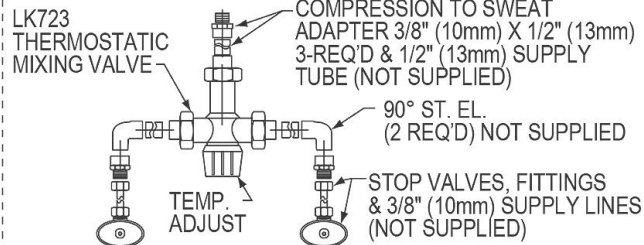

NOTE:  
USE TEFLON TAPE FOR ALL WATER CONNECTIONS.  
DO NOT USE PIPE DOPE.

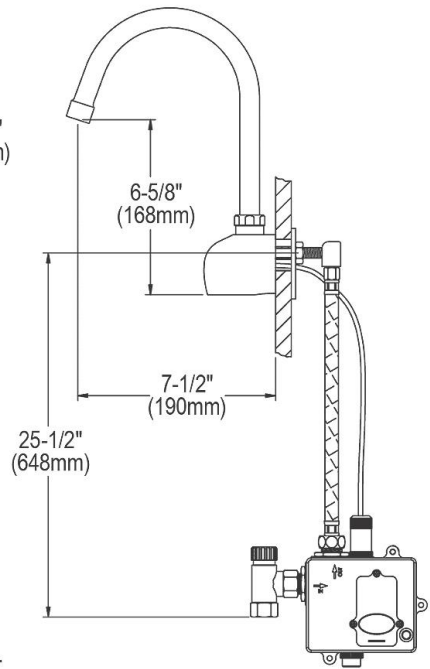

In keeping with our policy of continuing product improvement, Elkay reserves the right to change product specifications without notice. Please visit [elkay.com](http://elkay.com) for the most current version of Elkay product specification sheets. This specification describes an Elkay product with design, quality, and functional benefits to the user. When making a comparison of other producers' offerings, be certain these features are not overlooked.