

# ALPHA CS

Installation and operating instructions





# ALPHA CS

---

## English (US)

Installation and operating instructions . . . . .	4
<b>Limited consumer warranty . . . . .</b>	<b>25</b>

<b>Original installation and operating instructions</b>	12.8	No hot water at the faucet . . . . .	21
<b>Table of contents</b>	12.9	Very hot water in the cold-water return pipe . . . . .	21
<b>1. General information . . . . .</b>	<b>5</b>	12.10 Alarms . . . . .	22
1.1 Hazard statements . . . . .	5	12.11 Warnings . . . . .	23
1.2 Notes . . . . .	5	<b>13. Technical data . . . . .</b>	<b>24</b>
<b>2. Product introduction . . . . .</b>	<b>6</b>	<b>14. Disposing of the product . . . . .</b>	<b>24</b>
2.1 ALPHA CS . . . . .	6	<b>15. Document quality feedback . . . . .</b>	<b>24</b>
2.2 Intended use . . . . .	6		
2.3 Pumped liquids . . . . .	6		
2.4 Identification . . . . .	7		
<b>3. Approvals . . . . .</b>	<b>8</b>		
3.1 Approvals of pump . . . . .	8		
3.2 Approvals for Comfort Valve . . . . .	8		
<b>4. Receiving the product . . . . .</b>	<b>8</b>		
4.1 Inspecting the product . . . . .	8		
4.2 Scope of delivery . . . . .	8		
<b>5. Installation requirements . . . . .</b>	<b>9</b>		
5.1 Radio frequency radiation exposure information (for Canada and US only) . . . . .	9		
5.2 Optimal installation and operation . . . . .	9		
<b>6. Mechanical installation . . . . .</b>	<b>10</b>		
6.1 Installation diagram . . . . .	10		
6.2 Mounting the product . . . . .	10		
6.3 Changing the control box position . . . . .	11		
6.4 Installation of Comfort Valve . . . . .	12		
<b>7. Electrical connection . . . . .</b>	<b>13</b>		
<b>8. Starting up the product . . . . .</b>	<b>14</b>		
<b>9. Control functions . . . . .</b>	<b>14</b>		
9.1 Operating panel . . . . .	14		
9.2 Light fields indication . . . . .	15		
9.3 Control modes . . . . .	15		
<b>10. Setting of the product . . . . .</b>	<b>16</b>		
10.1 Connecting the product to Grundfos GO . . . . .	16		
10.2 Guided setup . . . . .	17		
10.3 Flow limitation . . . . .	17		
10.4 Trend data . . . . .	17		
10.5 Updating the software . . . . .	17		
10.6 Resetting to factory settings . . . . .	17		
<b>11. Service . . . . .</b>	<b>18</b>		
<b>12. Fault finding . . . . .</b>	<b>19</b>		
12.1 Fault indication on the pump operating panel . . . . .	20		
12.2 Overview of alarm and warning codes . . . . .	20		
12.3 Resetting alarms and warnings manually with Grundfos GO . . . . .	21		
12.4 Alarm and warning code logs . . . . .	21		
12.5 Automatic deblocking . . . . .	21		
12.6 Overheated boiler . . . . .	21		
12.7 Noise in the system . . . . .	21		

## 1. General information



Read this document before you install the product. Installation and operation must comply with local regulations and accepted codes of good practice.

### 1.1 Hazard statements

The symbols and hazard statements below may appear in Grundfos installation and operating instructions, safety instructions and service instructions.



#### **DANGER**

Indicates a hazardous situation which, if not avoided, will result in death or serious personal injury.



#### **WARNING**

Indicates a hazardous situation which, if not avoided, could result in death or serious personal injury.



#### **CAUTION**

Indicates a hazardous situation which, if not avoided, could result in minor or moderate personal injury.

The hazard statements are structured in the following way:



#### **SIGNAL WORD**

##### **Description of the hazard**

Consequence of ignoring the warning

- Action to avoid the hazard.

## 1.2 Notes

The symbols and notes below may appear in Grundfos installation and operating instructions, safety instructions and service instructions.



Observe these instructions for explosion-proof products.



A blue or gray circle with a white graphical symbol indicates that an action must be taken.



A red or gray circle with a diagonal bar, possibly with a black graphical symbol, indicates that an action must not be taken or must be stopped.



If these instructions are not observed, it may result in malfunction or damage to the equipment.



Tips and advice that make the work easier.

## 2. Product introduction

### 2.1 ALPHA CS



TM085783

#### ALPHA CS

ALPHA CS is designed for domestic hot-water recirculation systems without a dedicated return line. The comfort system comes with a bypass valve with a thermal actuator. The built-in digital timer makes it possible to schedule the pump's on/off hours, helping save energy when hot water is not required in the home.

The pump provides hot water in an instant to the hot-water faucets in your home. Since the solution utilizes the existing cold-water supply line as a return line in your home, no separate new return line is required. No electrical power is required under the sink.

The product moreover features:

- An integrated digital timer that eliminates the need for a physical programmable timer.
- Homeowner scheduling via the Grundfos HOME app.
- Plug and play control mode with AUTOADAPT.
- Easier selection with the Grundfos GO replacement compatibility check.
- Reduced risk of flow accelerated corrosion with flow limit.
- Reduced fluctuation in shower temperatures with FLOWSENSE.

### 2.2 Intended use

This pump is intended for indoor residential drinking water use only and is to be considered where there is no hot-water return line available.

The pump is lubricated and cooled by the liquid being pumped. Therefore, the pumped liquid must be allowed to circulate through the pump while it is in operation.

### 2.3 Pumped liquids

#### WARNING

##### Electric shock

Death or serious personal injury



- For indoor use only.
- This pump has not been investigated for use in swimming pool or marine areas.

#### WARNING

##### Fire or explosion hazard

Death or serious personal injury



- The pump must not be used for the transfer of flammable liquids such as diesel oil, gasoline and similar liquids.

The product is suitable for pumping clean, thin, non-aggressive and non-explosive liquids without solid particles or fibers or mineral oils.

If required, 50 % of the volume solution of glycol and water can be used. However, a decrease in pump performance may occur due to an increase in the viscosity of the solution. Contact the manufacturer for information regarding suitability of the pump for pumping other liquids.

The pump is designed to circulate water from 36 to 203 °F (2 to 95 °C) up to a maximum pressure of 175 psi (12 bar), depending on the variant.

## 2.4 Identification

### 2.4.1 Nameplate

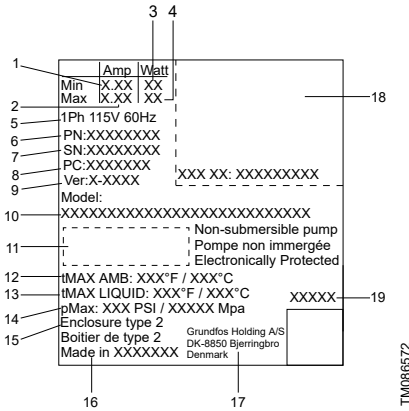

Pos.	Description
1	Min. current consumption
2	Max. current consumption
3	Min. power consumption
4	Max. power consumption
5	Number of phases, voltage and frequency
6	Product number
7	Serial number
8	Factory code and production code (year and week)
9	Version letter and update number
10	Pump model
11	Enclosure class
12	Max. ambient temperature
13	Max. liquid temperature
14	Max. system pressure
15	Enclosure type
16	Country of origin
17	Grundfos address
18	Approvals
19	Combined legal product code

### 2.4.2 Type key

Example: ALPHA CS 15-55 SU7P/TLC 115V 9H

Code	Explanation	Designation
ALPHA	Grundfos circulator with Comfort Valve	Pump type
CS		
15	R 1/2" G1"	Nominal diameter
55	18 ft (5.5 m)	Max. head
S	Stainless steel	Pump housing
U	Union	
7P	3/4" NPT(M) x 3/4" NPT(F)	Pipe connection
T	Integrated timer	
LC	Line cord	Power connection
115V	115 V	Voltage
230V	230 V	
3H	3 o'clock (right)	Control box position
6H	6 o'clock (below)	
9H	9 o'clock (left)	
0H	12 o'clock (top)	

### 3. Approvals

#### 3.1 Approvals of pump

##### Approval marks



NSF listing is only valid for temperatures up to 140 °F.



This equipment has been tested and found to comply with the limits for a class B digital device, pursuant to Part 15 of the FCC Rules.



Any changes or modifications to this equipment not expressly approved by the party responsible for compliance could void the user's authority to operate this equipment.

These limits are designed to provide reasonable protection against harmful interference in a residential installation. This equipment generates, uses and can radiate radio frequency energy and, if not installed and used in accordance with the instructions, may cause harmful interference to radio communications. However, there is no guarantee that interference will not occur in a particular installation. If this equipment does cause harmful interference to radio or television reception, which can be determined by turning the equipment off and on, the user is encouraged to try to correct the interference by one or more of the following measures:

- Reorient or relocate the receiving antenna.
- Increase the separation between the equipment and receiver.
- Connect the equipment to an outlet on a circuit different from that to which the receiver is connected.
- Consult the dealer or an experienced radio/TV technician for help.

#### 3.2 Approvals for Comfort Valve



NSF listing is only valid for temperatures up to 140 °F.

### 4. Receiving the product

#### 4.1 Inspecting the product

##### CAUTION

###### Crushing of feet

- Minor or moderate personal injury
- Wear safety shoes when handling the product.



##### CAUTION

###### Sharp element

- Minor or moderate personal injury
- Wear protective gloves.



1. Make sure that the delivered product corresponds to the order.
2. Make sure that the voltage and frequency of the product match the voltage and frequency of the installation site.

#### 4.2 Scope of delivery

The box contains the following items:

- 1 pump with power connector
- 1 Comfort Valve
- 2 hoses
- 2 adapters 3/8" x 1/2" with seal washers
- 2 gaskets
- 1 quick guide
- 1 safety instructions booklet.



## 5. Installation requirements

### 5.1 Radio frequency radiation exposure information (for Canada and US only)

#### CAUTION

##### Radiation

Minor or moderate personal injury



- This equipment complies with FCC and ISED radiation exposure limits set forth for an uncontrolled environment. This equipment must be installed and operated with a minimum distance of 20 cm (0.66 ft) between the radiator and your body.

### 5.2 Optimal installation and operation

See below for information for optimizing the installation and setting of the product:

- In order to create a flow in a system, the pump needs to neutralize the system head loss before it can create a flow in the system.
- When mounting the pump, ensure that the shaft is in a horizontal position to avoid air being trapped inside or bearings being worn out too quickly.
- Make sure that you have the proper voltage and that the wires are connected properly (black = phase, white = neutral, green or bare copper = ground).
- When using ALPHA COMFORT SYSTEM on larger systems, where you are using two or more comfort valves, make sure that the pipe resistance is the same for all loops, otherwise, the flow will be uneven, and some loops might not function correctly if the hoses from the faucets are 1/2" size, mount the 3/8" × 1/2" adapters supplied with the pump on Comfort Valve.
- Comfort Valve is a thermal valve that regulates its opening degree based on the temperature of the media on the hot side of the valve. Comfort Valve allows for maintaining a desired hot side temperature at Comfort Valve. The temperature is completely regulated by the valve with the pump driving the flow of the supply line with hot water from the heat source.
- When using ALPHA COMFORT SYSTEM on very large systems (pipe 1" and above), we recommend making a "side by" installation for the pump to avoid a flow restriction through the pump. See example below.

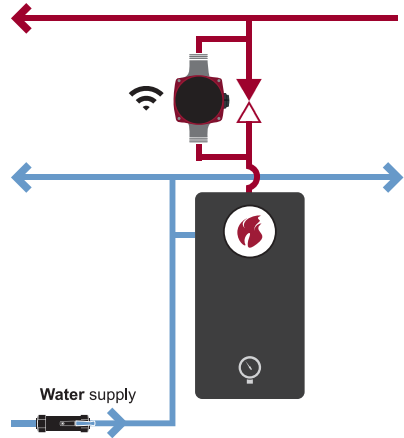

*By-pass solution*

TM085918

## 6. Mechanical installation

### WARNING

#### Electric shock

Death or serious personal injury

- A damaged product must be repaired or replaced by Grundfos or a service workshop authorized by Grundfos.



### CAUTION

#### Crushing of feet

Minor or moderate personal injury

- Wear safety shoes when opening the box and handling the product.



### CAUTION

#### Sharp element

Minor or moderate personal injury

- Wear protective gloves.



The pump must always be installed with a horizontal motor shaft within  $\pm 5^\circ$ .



The pump is a non-submersible pump.



Due to interference of the touchscreen, keep a distance of minimum 5 mm from the front of the operating panel to all conductive materials, for example, metal cabinets and cables.

### 6.1 Installation diagram

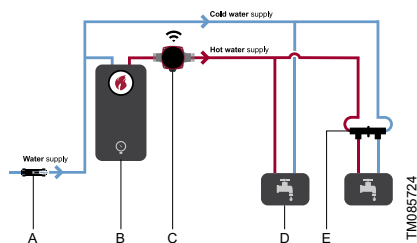

Diagram of ALPHA COMFORT SYSTEM installation

Pos.	Description
A	Shut-off valve, cold water supply
B	Heater
C	ALPHA COMFORT SYSTEM
D	Faucet
E	Comfort Valve

### 6.2 Mounting the product

The arrows on the pump housing indicate the flow direction through the pump.

1. Fit the two gaskets supplied, if applicable, with the pump when you mount the pump in the pipe. Make sure to install the pump with a horizontal motor shaft within  $\pm 5^\circ$ .

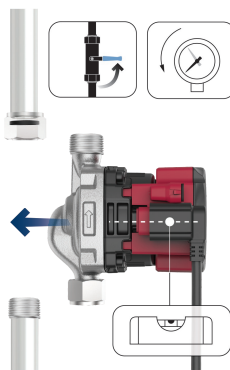

2. Tighten the fittings.

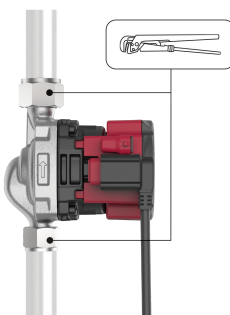

### 6.3 Changing the control box position

## CAUTION



### Hot surface

Minor or moderate personal injury

- Position the pump so that persons cannot accidentally come into contact with hot surfaces.

## WARNING



### Pressurized system

Minor or moderate personal injury

- Before dismantling the pump, drain the system or close the isolating valves on both sides of the pump. The pumped liquid may be scalding hot and under high pressure.



Make sure that the isolating valves are closed before rotating the control box. The pump must be pressureless before the control box is rotated. Drain the system or relieve the pressure inside the pump housing.

To change the position of the control box, do as follows:

1. Loosen and remove the four screws.

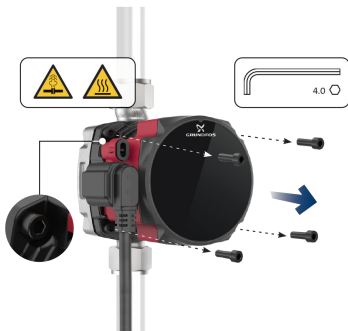

TM085779

2. Turn the pump head to the desired position.



TM085780

You can turn the control box in steps of 90°.



TM085782

3. Insert and cross-tighten the screws.



TM085781

## 6.4 Installation of Comfort Valve



Do not use Teflon tape, pipe joint compound or pipe dope on the valve threads.



Tighten the flex hose connections, plus 1/4 turn with a wrench. Overtightening the flex hose connections can result in valve damage, causing the valve to leak and/or localized water damage.



When making pipe connections, be sure to follow the pipe manufacturer's recommendations and all code requirements for pipe material.



By plumbing convention, the hot water is on the left side and the cold water on the right side, when looking at the sink. Your pipes may be different.

### 6.4.1 Valve location

For the greatest effect, Comfort Valve must be located at a faucet with the greatest pipe distance from the hot-water heater. If a household consists of more than one hot-water pipe string, one Comfort Valve must be mounted in each string.

### 6.4.2 Disconnecting the risers

1. Close both the hot-water and cold-water angle stop valves below the sink.

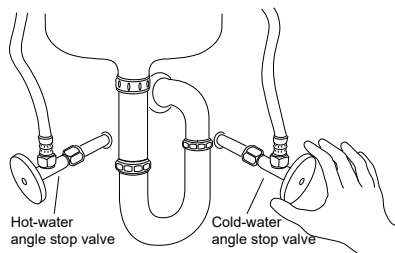

2. Disconnect the risers.

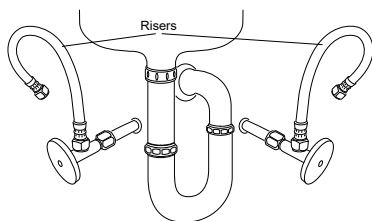

### 6.4.3 Installing the thermal bypass valve

Mounting hardware is not included.

1. Connect the 1/2" x 1/2" flex hoses to the ports on the thermal bypass valve marked **HOT OUT** and **COLD OUT**.

2. Connect the 1/2" x 3/8" flex hoses to the ports on the thermal bypass valve marked **HOT IN** and **COLD IN**.
3. Connect the 1/2" hose fitting from the **HOT OUT** port on the thermal bypass valve to the left side of the faucet.
4. Connect the 1/2" hose fitting from the **COLD OUT** port on the thermal bypass valve to the right side of the faucet.
5. Connect the 3/8" hose fitting from the **HOT IN** port on the thermal bypass valve to the left angle stop valve.
6. Connect the 3/8" hose fitting from the **COLD IN** port on the thermal bypass valve to the right angle stop valve.
7. Open both hot-water and cold-water angle stop valves. Check for leaks.

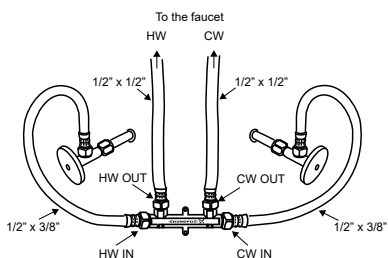

Connection of thermal bypass valve, flex hoses and fittings

8. The thermal bypass valve may be mounted to the wall with screws if desired.

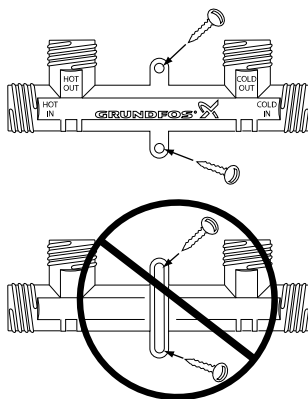

Correct installation of thermal bypass valve (mounting hardware not included)

#### 6.4.4 Checking for proper pump and bypass valve operation

After installing the pump and the bypass valve, connect the pump to the power supply and check the installation as follows:

1. Close the angle stop valve for the cold water below the sink.
2. Open the cold-water faucet.
3. Check that when you turn on the cold-water faucet, the flow of cold water gradually decreases and stops as the bypass valve closes.
4. Check that when you turn on the hot-water faucet, hot water will flow within seconds.

## 7. Electrical connection

### WARNING

#### Electric shock

Death or serious personal injury

- Switch off the power supply before you start any work on the product. Make sure that the power supply cannot be switched on accidentally.



### WARNING

#### Electric shock

Death or serious personal injury

- Connect the product only to a properly grounded receptacle.



### WARNING

#### Electric shock

Death or serious personal injury

- All electrical connections must be carried out by a qualified electrician in accordance with local regulations.



### WARNING

#### Electric shock

Death or serious personal injury

- Use of the product on a circuit equipped with a GFCI can cause improper operation of the GFCI. Consult an electrician and observe all national, state and local electrical regulations, as applicable.



- The pump is electronically protected and therefore requires no external motor protection.
- Check that the supply voltage and frequency correspond to the values stated on the nameplate.
- Connect the pump to the power supply with the power connector supplied with the pump.

## 8. Starting up the product

### CAUTION

#### Radiation

Minor or moderate personal injury



- This equipment complies with FCC and ISED radiation exposure limits set forth for an uncontrolled environment. This equipment must be installed and operated with a minimum distance of 20 cm (0.66 ft) between the radiator and your body.

1. Fill the system with liquid and vent it.
2. Make sure the required minimum inlet pressure is available at the pump inlet.
3. Switch on the power supply.

The pump is factory set to valve AUTOADAPT.

You can change the settings on the operating panel or via Grundfos GO. We recommend to follow the guided setup in Grundfos GO.

## 9. Control functions

### 9.1 Operating panel

LED symbols and buttons on the pump display

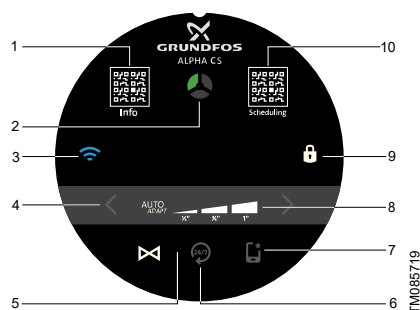

TM085719

Pos.	Description
6	Always on Grundfos GO
7	The pump has been set via Grundfos GO.
8	Settings for the selected control mode 1/2", 3/4", 1" or AUTOADAPT Lock This indicates that the operating panel is locked and no buttons can be used. It automatically locks after a few seconds. To unlock the panel, push and hold the icon for 1 second.
9	
10	QR code for Grundfos GO and Grundfos HOME landing page

The operating panel has a touchscreen which means you can change settings by touching the icons on the operating panel.



Due to interference of the touchscreen, keep a distance of minimum 5 mm from the front of the operating panel to all conductive materials, for example, metal cabinets and cables.









Pos.	Description
1	QR code for Grundfos Product Center
2	The indicator light shows the operating status of the product.
3	Connect If lit, the pump is connected to Grundfos GO via Bluetooth.
4	Settings for control modes Use the arrows to toggle between the control modes.
5	Control mode You can select the control mode COMFORT SYSTEM AUTOADAPT.

## 9.2 Light fields indication

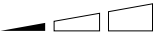
The LEDs indicate the control mode, setting and operating status.

### Factory setting

The pump is factory set to Comfort Valve AUTOADAPT.

Active light fields	Description
	When the pump is set via Grundfos GO, the icon is lit and the modes and settings on the operating panel are switched off.
	Valve opening The pump is operating with Comfort Valve mounted in the pipe system and runs in constant curve III with 1 gpm until Comfort Valve closes due to correct temperature.
	Setting 1/2" - constant curve III with 1.5 gpm max. flow rate
	Setting 3/4" - constant curve III with 2.3 gpm max. flow rate
	Setting 1" - constant curve III with 3.8 gpm max. flow rate
	The pump is running. <sup>1)</sup>
	Warning <sup>1)</sup>
	Alarm

<sup>1)</sup> The rotation of Grundfos mini Eye follows the direction of rotation of the impeller. The impeller in ALPHA rotates counterclockwise.

## 9.3 Control modes

The product can be set to the following control modes via the operating panel:

- AUTOADAPT
- continuous operation - 24/7.

The below control modes can be set via the Grundfos GO app:

- cycle time control
- constant curve
- constant pressure
- constant flow.

### 9.3.1 AUTOADAPT

This control mode ensures comfort via temperature controlled Comfort Valve actuation and is suitable for all hot-water recirculation applications without a dedicated return line.

During the first startup, the pump operates at its maximum curve with a flow limit of 1.2 gpm for at least 1 hour. During this initial startup procedure, the pump runs several cycles, each lasting 20 minutes (5 minutes on and 15 minutes standby) until the pump has learned the signature of a closed Comfort Valve based on changes in power and flow.

After the first startup, the pump automatically turns off when it detects a closed valve, enabling further energy savings.

### 9.3.2 Continuous operation - 24/7

This control mode ensures comfort 24/7 through continuous operation in constant curve III with flow limits.

The flow limits are based on predefined pipe diameters and flow limits (see below) to reduce flow accelerated corrosion and noise in the system. The predefined flow limits can be changed via Grundfos GO.

- 1/2" 1.5 gpm)
- 3/4" (2.3 gpm)
- 1" (3.8 gpm).

### 9.3.3 Cycle time control

The pump operates at its maximum curve, and it starts and stops based on time parameters. The default time parameters are 5 minutes on and 15 minutes off. The time parameters are adjustable through Grundfos Go.

### 9.3.4 Constant curve

The pump operates at a constant curve, which means that it runs at constant speed or power. The pump performance follows the selected constant curve.

This control mode is recommended in systems replacing old three-speed circulators where the required performance is known.

### 9.3.5 Constant pressure

The pump operates at a constant pressure which means the head is kept constant regardless of changes in the system. The pump performance follows the selected constant-pressure curve.

This control mode is recommended in systems with multiple risers and thermally actuated balancing valves.

### 9.3.6 Constant flow

The pump operates at a constant flow in the system regardless of the head.

This control mode is recommended when the pump is externally controlled, for example with an aquastat.

## 10. Setting of the product

### CAUTION

#### Radiation

Minor or moderate personal injury



- This equipment complies with FCC and ISED radiation exposure limits set forth for an uncontrolled environment. This equipment must be installed and operated with a minimum distance of 20 cm (0.66 ft) between the radiator and your body.

The operating panel can be used for the following:

- Connect to Grundfos GO.
- Lock and unlock the operating panel.
- Select constant pressure (zone valve) or constant curve (zone pump) control mode.
- Select pump setting (I, II, III or AUTOADAPT) for the two control modes available on the operating panel.
- Select to operate with Grundfos GO settings.

In Grundfos GO you can access all settings.

### 10.1 Connecting the product to Grundfos GO

Before connecting the product to Grundfos GO, the Grundfos GO app must be downloaded to your smartphone or tablet. The app is free of charge and available for iOS and Android devices.

The connection can be started either from the operating panel or Grundfos GO. If you have several products installed, we recommend starting the connection from the operating panel.

1. Open Grundfos GO on your device. Make sure that Bluetooth is enabled.  
Your device must be within reach of the product to establish Bluetooth connection.
2. Go to the **Remote** menu in Grundfos GO.
3. Press the connect icon on the operating panel.  
The connect icon flashes until your device is connected.
4. Press **CONNECT** in Grundfos GO.  
Once the connection is established, the LED is permanently on.  
Grundfos GO is now loading the data for the product.



## 10.2 Guided setup

After the pump is connected to Grundfos GO, we recommend that you follow the guided setup in Grundfos GO.

The guided setup helps you to select the optimal settings for the current system. By choosing the optimal settings, you can lower the energy consumption and prevent potential noise problems.

If you select **Use default settings**, the pump uses the factory setting, valve mode AUTOADAPT.

## 10.3 Flow limitation

You can set a minimum and maximum flow rate in Grundfos GO.

A minimum flow limit can be set to prevent the boiler from overheating. A maximum flow limit can be set to prevent noise in the system.

## 10.4 Trend data

In the **Trend data** menu in Grundfos GO, you can see system data for the last 10 or 100 on-cycles.

An on-cycle is the period from when the pump turns on until it turns off. If the pump runs continuously for more than 24 hours, one on-cycle is registered and a new on-cycle will start even though the pump has not yet turned off. The 100 cycles view consists of 10 observations where each observation is the average of 10 on-cycles.

You can see the following data:

- **Duration of each on-cycle**
- **Flow**
- **Head**
- **Estimated media temperature.**

You can use the trend data for system optimization and fault finding.

## 10.5 Updating the software

Follow the steps below to update the product's software via Grundfos GO:

1. Make sure your smart device has sufficient power.
2. Make sure your smart device is connected to the internet.

If there is no internet where the pump is installed, go to step 3 and then follow the instructions in Grundfos GO.

3. Connect your product to Grundfos GO if it is not already connected.

The app automatically checks if the product has the latest software installed. If a newer version is available, the text **New software available** appears on the dashboard in Grundfos GO. You can also check for software updates in the **Settings** menu.

4. Follow the guide in Grundfos GO to install the software update.

## 10.6 Resetting to factory settings

The product can be reset to factory settings in two ways:

- **Via Grundfos GO**
  1. Open Grundfos GO.
  2. Press the gear icon in the top right side of the screen.
  3. Go to the **Factory reset** menu and press **Reset**.
- **Via the operating panel**
  1. Press and hold the unit icon for 5 seconds.

## 11. Service

### WARNING

#### Electric shock

- All electrical connections must be carried out by a qualified electrician in accordance with local regulations.



### WARNING

#### Electric shock

- Death or serious personal injury
- Switch off the power supply before you start any work on the product. Make sure that the power supply cannot be switched on accidentally.



### WARNING

#### Electric shock

- Death or serious personal injury
- A damaged product must be repaired or replaced by Grundfos or a service workshop authorized by Grundfos.



### WARNING

#### Electric shock

- Death or serious personal injury
- Connect the product only to a properly grounded receptacle.



### WARNING

#### Pressurized system

- Minor or moderate personal injury
- Before dismantling the pump, drain the system or close the isolating valves on both sides of the pump. Slowly loosen the screws and unpressurize the system. The pumped liquid may be scalding hot and under high pressure.



### WARNING

#### Hot surface

- Minor or moderate personal injury
- The pump housing may be hot due to the pumped liquid being scalding hot. Close the isolating valves on both sides of the pump and wait for the pump housing to cool down.



### CAUTION

#### Sharp element

- Minor or moderate personal injury
- Wear protective gloves.



### CAUTION

#### Crushing of feet

- Minor or moderate personal injury
- Wear safety shoes when moving the product.



### CAUTION

#### Explosive environment

- Minor or moderate personal injury
- Risk of explosion if the battery is replaced by an incorrect type.
- Dispose of used batteries according to the instructions.



### CAUTION

#### Radiation

- Minor or moderate personal injury
- This equipment complies with FCC and ISED radiation exposure limits set forth for an uncontrolled environment. This equipment must be installed and operated with a minimum distance of 20 cm (0.66 ft) between the radiator and your body.



## 12. Fault finding

### WARNING

#### Electric shock

Death or serious personal injury



- Switch off the power supply before you start any work on the product. Make sure that the power supply cannot be switched on accidentally.

### WARNING

#### Electric shock

Death or serious personal injury



- A damaged product must be repaired or replaced by Grundfos or a service workshop authorized by Grundfos.

### WARNING

#### Hot surface

Minor or moderate personal injury



- The pump housing may be hot due to the pumped liquid being scalding hot. Close the isolating valves on both sides of the pump and wait for the pump housing to cool down.

### CAUTION

#### Pressurized system

Minor or moderate personal injury



- Before dismantling the pump, drain the system or close the isolating valves on both sides of the pump. The pumped liquid may be scalding hot and under high pressure.

### CAUTION

#### Radiation

Minor or moderate personal injury





- This equipment complies with FCC and ISED radiation exposure limits set forth for an uncontrolled environment. This equipment must be installed and operated with a minimum distance of 20 cm (0.66 ft) between the radiator and your body.

## 12.1 Fault indication on the pump operating panel

Faults preventing the pump from operating properly are indicated on the operating panel with Grundfos mini Eye turning either yellow or red and the display showing an error code.











A warning is indicated when one indicator light in Grundfos mini Eye is turning yellow and rotating. The pump does not perform as expected, and action is required in case of underheating or discomfort.

An alarm is indicated when two indicator lights in Grundfos mini Eye are flashing red and the pump stops. Action is required.

Grundfos mini Eye	Description
	Warning indication
	Alarm indication

## 12.2 Overview of alarm and warning codes

### Fault chart

Grundfos mini Eye	Code in Grundfos GO	Fault
	51	Blocked motor
	40	Undervoltage
	29	Forced pumping
	4	Overvoltage
	72	Internal fault
	76	Internal fault
	85	Internal fault
	57	Dry running
	43	Impellers forced forward
	35	Air in media

### 12.3 Resetting alarms and warnings manually with Grundfos GO

1. Go to **Alarms and warnings**.
2. Press **Reset alarm**.  
All current alarms and warnings have been reset. However, if the fault causing the alarm or warning has not been removed, the alarm or warning will appear again.
3. If you want to delete all alarms and warnings from the history log, press **Show log > Reset alarm and warning logs**.

### 12.4 Alarm and warning code logs

Grundfos GO will save up to 40 alarms and warnings in total in the **Alarms and warnings** menu.

### 12.5 Automatic deblocking

In case of a blocked rotor, the pump will start vibrating automatically with a frequency of around 3 Hz during startup. Any dirt deposits that might prevent the impeller from rotating will be broken up swiftly, and the pump will resume normal operation.

### 12.6 Overheated boiler

Cause	Remedy
The flow is too low.	<ul style="list-style-type: none"> <li>• Increase the flow.</li> </ul>

### 12.7 Noise in the system

Cause	Remedy
The flow is too high.	<ul style="list-style-type: none"> <li>• Lower the flow.</li> </ul>
There is air in the system	<ol style="list-style-type: none"> <li>1. Connect to Grundfos GO.</li> <li>2. Select the <b>Settings</b> menu.</li> <li>3. Select <b>Vent pump (15 minutes)</b>.</li> <li>4. Press <b>Start venting</b>.</li> </ol>

### 12.8 No hot water at the faucet

Cause	Remedy
The valve is not installed correctly.	<ul style="list-style-type: none"> <li>• Review the bypass valve installation instruction. If necessary, reinstall Comfort Valve.</li> <li>• Replace Comfort Valve.</li> </ul>

### 12.9 Very hot water in the cold-water return pipe

Cause	Remedy
The valve is not installed correctly.	<ul style="list-style-type: none"> <li>• Review the bypass valve installation instruction. If necessary, reinstall Comfort Valve.</li> <li>• Replace Comfort Valve.</li> </ul>

## 12.10 Alarms

### 12.10.1 Code 51 (Blocked motor)

Grundfos mini Eye is flashing red, the displays show error code **E1** and the pump stops.

Cause	Remedy
The pump is blocked.	Only a qualified specialist must perform such work. <ol style="list-style-type: none"> <li>1. Isolate the pump.</li> <li>2. Remove the pump head.</li> <li>3. Remove the deposits.</li> </ol>

### 12.10.2 Code 40 (Undervoltage)

Grundfos mini Eye is flashing red, the displays show error code **E2** and the pump stops.

Cause	Remedy
The supply voltage to the pump is too low.	<ul style="list-style-type: none"> <li>• Make sure that the power supply is within the specified range.</li> </ul>

### 12.10.3 Code 29 (Forced pumping)

Grundfos mini Eye is flashing red, the displays show error code **E3** and the pump stops.

Cause	Remedy
Other pumps or sources generate flow through the pump even if the pump is switched off.	<ul style="list-style-type: none"> <li>• Switch off the pump at the main switch. If the light in the pump display is on, the pump is running in forced pumping mode.</li> <li>• Check the system for the correct position of the non-return valves.</li> <li>• Check the system for defective non-return valves and replace the valves if necessary.</li> </ul>

### 12.10.4 Code 74 (Overvoltage)

Grundfos mini Eye is flashing red, the displays show error code **E3** and the pump stops.

Cause	Remedy
The supply voltage to the pump is too high.	<ul style="list-style-type: none"> <li>• Make sure that the power supply is within the specified range.</li> </ul>

### 12.10.5 Code 72 (Internal fault)

Grundfos mini Eye is flashing red, the displays show error code **E3** and the pump stops.

Cause	Remedy
Internal fault.	<ul style="list-style-type: none"> <li>• Replace the pump and dispose in an environmentally sound way according to local regulations, or contact Grundfos Service.</li> </ul>

**12.10.6 Code 76 (Internal fault)**

Grundfos mini Eye is flashing red, the displays show error code **E3** and the pump stops.

Cause	Remedy
Internal fault.	<ul style="list-style-type: none"> <li>Replace the pump and dispose in an environmentally sound way according to local regulations, or contact Grundfos Service.</li> </ul>

**12.10.7 Code 85 (Internal fault)**

Grundfos mini Eye is flashing red, the displays show error code **E3** and the pump stops.

Cause	Remedy
Internal fault.	<ul style="list-style-type: none"> <li>Replace the pump and dispose in an environmentally sound way according to local regulations, or contact Grundfos Service.</li> </ul>

**12.10.8 Code 57 (Dry running)**

Grundfos mini Eye is flashing red, the displays show error code **E4** and the pump stops.

Cause	Remedy
Water is missing in the system or the system pressure is too low.	<ul style="list-style-type: none"> <li>Fill the system with the correct amount of liquid.</li> <li>Prime and vent the pump before a new startup.</li> </ul>

**12.11 Warnings****12.11.1 Code 43 (Impellers forced forward)**

One indicator light in Grundfos mini Eye is yellow and rotating, the display shows error code **E3** and the pump is running.

Cause	Remedy
Other pumps or sources generate flow through the pump even if the pump is switched off.	<ul style="list-style-type: none"> <li>Switch off the pump at the main switch. If the light in the pump display is on, the pump is running in forced pumping mode.</li> <li>Check the system for the correct position of the non-return valves.</li> <li>Check the system for defective non-return valves and replace the valves if necessary.</li> </ul>

**12.11.2 Code 35 (Air in media)**

This is not shown on the operating panel. It is logged and can be seen in Grundfos GO.

Cause	Remedy
There is air in the pump and/or system.	<ul style="list-style-type: none"> <li>Vent the pump and system.</li> <li>If the problem persists, investigate the system for leakages.</li> </ul>

### 13. Technical data

Flow rate(Q)	Max. 13.6 gpm (3.1 m <sup>3</sup> /h)
Head (H)	Max. 18 ft (5.5 m)
Supply voltage	1 × 115 V, ± 10 %, 60 Hz
Motor protection	The pump requires no external motor protection.
Power usage (approximate)	Min. 2 - max. 38 W
Enclosure class	Indoor use only. Enclosure type 2.
Insulation class	F
Ambient temperature	32-131 °F (0-55 °C)
Liquid temperature	36-203 °F (2-95 °C) <sup>2)</sup>
Relative humidity	Max. 95 %
Max. outlet pressure	175 psi (12 bars) (1.2 MPa)
Sound pressure level	< 25 dB(A)
Approvals	cULus and FCC
	The product complies to limits for class B digital device, pursuant to Part 15 of the FCC Rules.
Port-to-port length	5.31" (135 mm)
Pump housing	Stainless steel
Connection type	3/4" NPT(M) × 3/4" NPT(F)
Connections	Comfort Valve: ½" NPS(M)
	Flex hose: ½" NPS(F) × ½" NPS(F) × 12"

<sup>2)</sup> Hard water deposits can occur at temperatures over 140 °F (60 °C).

#### Inlet pressure

Liquid temperature [°F (°C)]	Min. inlet pressure [psi (bar)]
167 (75)	0.75 (0.05)
203 (95)	7.25 (0.5)
230 (110)	15.7 (1.08)

### 14. Disposing of the product

This product or parts of it must be disposed of in an environmentally sound way.

1. Use the public or private waste collection service.
2. If this is not possible, contact the nearest Grundfos company or service workshop.

See also end-of-life information at [www.grundfos.com/product-recycling](http://www.grundfos.com/product-recycling).

### 15. Document quality feedback

To provide feedback about this document, scan the QR-code using your phone's camera or a QR code app.



[Click here to submit your feedback](#)



## Limited consumer warranty

### 1. Limited consumer warranty

This Limited Warranty is provided for Consumer Products sold in the United States only and applies to Consumer Transactions as defined in and applicable under the Magnusson-Moss Warranty Act and any other applicable Federal and/or State laws. In case of non-Consumer Products, please refer to Grundfos' warranty terms defined in clause 10 of Grundfos US Terms and Conditions of Sale of Product and Services available at <https://www.grundfos.com/legal/grundfos-customer-terms/usa-grundfos-general-terms-for-sales-of-products-and-services>

**This Limited Warranty gives you specific legal rights, and you may also have other rights which vary from State to State.**

New products manufactured by Grundfos are warranted to the original purchaser only and are to be free from defects in design, material and workmanship under normal use and service for no greater than a period of thirty (30) months from the date of manufacture which is set forth on the product's nameplate and on the product's packaging or the minimum period required by the applicable State law. For New Jersey, the applicable period is one year from the date of purchase.

The warranty period for replacement products, parts and components expires thirty (30) months from the original date of manufacture of the product originally purchased, unless a longer period is required under the applicable State law. For New Jersey, the warranty period for replacement products, parts and components expires one year from the original date of purchase of the product, not the date of replacement.

Products sold by Grundfos that are manufactured by others are not covered by this warranty.

**Note that when purchasing a Grundfos product online, it is important to check the date of manufacture and the duration of the warranty with the seller as the product might no longer be covered under this Limited Warranty.**

**When a product is subject to this Limited Warranty a purchaser should contact the seller from which it purchased the product to make a claim.**

If the seller of a product is no longer in business, the purchaser should contact a Grundfos Authorized Service Partner, which can be found at [www.grundfos.com/us](http://www.grundfos.com/us) under > Support > Contact Service.

As part of making a claim, a purchaser shall return a defective product at the purchaser's cost, to the extent allowed by applicable law, along with proof of purchase and an explanation of the defect, date the defect occurred and circumstances surrounding the defect. For New

Jersey there is no prohibition on returning a defective product at a purchaser's cost. If Grundfos is required by applicable State law to pay for the cost of shipment under applicable State law, then a purchaser should contact a Grundfos Authorized Service Partner to arrange for shipment. A purchaser also needs to promptly respond to Grundfos as to any inquiries regarding a warranty claim.

**Grundfos' liability under this Limited Warranty to purchaser is limited to the repair or replacement of a product (at Grundfos' decision) that is the sole and exclusive remedy for purchaser to the extent permissible by applicable law.** For New Jersey this limitation is permissible.

This warranty does not cover the following: ordinary wear and tear; use of a product for applications for which it is not intended; use of a product in an unsuitable environment; modifications, alterations or repair undertaken by anyone not acting with Grundfos' written authorization; failure to follow Grundfos' instructions, operations manuals, any other guidelines or good industry practice; use of faulty or inadequate ancillary equipment in combination with a product; application of spare or replacement parts not provided or authorized by Grundfos; accidental or intentional damage or misuse of a product.

The time period for making a claim under the implied warranty of merchantability and implied warranty of fitness are limited to the same time period as provided by this warranty to the extent permissible by applicable law. For residents of New Jersey, this limitation is permissible, but note that some states do not allow limitations on how long an implied warranty lasts, so the above limitation may not apply to you.

**Grundfos shall not be liable for any incidental and consequential damages in connection with a product to the extent permissible by applicable law.** For residents of New Jersey, this limitation is permissible, but note that some states do not allow limitations of incidental or consequential damages, so the above limitation may not apply to you.

## 2. Garantía limitada del consumidor

Esta garantía limitada se proporciona únicamente para los productos de consumo vendidos en los Estados Unidos y es aplicable a las transacciones de consumo tal y como se define en y resulta aplicable en virtud de la ley de Garantías Magnusson-Moss y cualquier otra legislación federal y/o estatal aplicable. Para el caso de productos que no sean de consumo, consulte los términos de la garantía de Grundfos definidos en la cláusula 10 de los términos y condiciones de venta de productos y servicios de Grundfos para los EE. UU., disponibles en <https://www.grundfos.com/legal/grundfos-customer-terms/usa-grundfos-general-terms-for-sales-of-products-and-services>.

**Esta garantía limitada le confiere derechos legales específicos. Puede que también tenga otros derechos en virtud de su jurisdicción estatal.**

Se garantiza únicamente al comprador original que los productos fabricados por Grundfos estarán libres de defectos de diseño, materiales y mano de obra en condiciones normales de uso y servicio durante un periodo no mayor a treinta (30) meses a partir de la fecha de fabricación que figura en la placa de datos del producto y en el empaque del mismo o el periodo mínimo exigido por la legislación estatal aplicable. Para Nueva Jersey, el periodo aplicable es de un año a partir de la fecha de compra.

El periodo de garantía para los productos, partes y componentes de repuesto vence a los treinta (30) meses contados a partir de la fecha de fabricación original del producto adquirido en primer lugar, a menos que la legislación estatal aplicable exija un periodo más largo. Para Nueva Jersey, el periodo de garantía de los productos, partes y componentes de repuesto vence un año contado a partir de la fecha original de compra del producto, no de la fecha de sustitución.

Los productos vendidos por Grundfos que sean producidos por otros fabricantes no están cubiertos por esta garantía.

**Tenga en cuenta que, al comprar un producto Grundfos en línea, es importante revisar la fecha de fabricación y la duración de la garantía con el vendedor, ya que es posible que el producto ya no esté cubierto por esta garantía limitada.**

**Cuando un producto esté sujeto a esta garantía limitada, el comprador deberá ponerse en contacto con el vendedor al que haya comprado el producto para presentar una reclamación.**

Si el vendedor de un producto ya no está en el negocio, el comprador debe ponerse en contacto con socio de servicio autorizado por Grundfos, que puede encontrar en la dirección [www.grundfos.com/us](http://www.grundfos.com/us), en la sección "Support" > "Contact Service".

Como parte de la presentación de una reclamación, el comprador deberá devolver el producto descompuesto a su costa, en la medida en la que lo permita la legislación aplicable, junto con el comprobante de compra y una explicación del defecto, la fecha en que este se haya producido y las circunstancias en torno al defecto. En Nueva Jersey no existe ninguna prohibición de devolver un producto descompuesto a costa del comprador. Si la legislación estatal aplicable obliga a Grundfos a hacerse cargo de los gastos de envío, el comprador deberá ponerse en contacto con un servicio técnico autorizado por Grundfos para organizar el envío. El comprador también debe responder con prontitud a Grundfos cualquier consulta relacionada con una reclamación de garantía.

**La responsabilidad de Grundfos hacia el comprador en virtud de esta garantía limitada se limita a la reparación o sustitución de un producto (a decisión de Grundfos), que es el único y exclusivo remedio para el comprador en la medida permitida por la legislación aplicable.** Para Nueva Jersey, esta limitación resulta permisible.

Esta garantía no cubre lo siguiente: el desgaste ordinario; el uso de un producto para aplicaciones para las que no está diseñado; el uso de un producto en un entorno inadecuado; las modificaciones, alteraciones o reparaciones realizadas por cualquier persona que no actúe con la autorización por escrito de Grundfos; el incumplimiento de las instrucciones, manuales de operación, cualquier otro lineamiento o las buenas prácticas industriales de Grundfos; el uso de equipos auxiliares descompuestos o inadecuados en combinación con un producto; el uso de repuestos o partes de sustitución no proporcionados ni autorizados por Grundfos; el daño accidental o deliberado o el uso indebido de un producto.

El periodo para presentar una reclamación en virtud de la garantía implícita de comerciabilidad y la garantía implícita de idoneidad se limita al mismo periodo previsto por esta garantía en la medida permitida por la legislación aplicable. Para los residentes de Nueva Jersey, esta limitación resulta permisible, si bien se debe tener en cuenta que algunos estados no permiten limitaciones en cuanto a la duración de una garantía implícita, por lo que la limitación anterior puede no resultar aplicable en su caso.

**Grundfos no será responsable de ningún daño indirecto o consecuente en relación con un producto en la medida en la que lo permita la legislación aplicable.** Para los residentes de Nueva Jersey, esta limitación resulta permisible, si bien se debe tenerse en cuenta que algunos estados no permiten limitaciones en cuanto a daños indirectos o consecuentes, por lo que la limitación anterior puede no resultar aplicable en su caso.

**U.S.A.**

Global Headquarters for WU  
856 Koomey Road  
Brookshire, Texas 77423 USA  
Phone: +1-630-236-5500

GRUNDFOS CBS Inc.  
902 Koomey Road  
Brookshire, TX 77423 USA  
Phone: 281-994-2700  
Toll Free: 1-800-955-5847  
Fax: 1-800-945-4777

GRUNDFOS Pumps Corporation  
9300 Loiret Boulevard  
Lenexa, Kansas 66219 USA  
Tel.: +1 913 227 3400  
Fax: +1 913 227 3500

**Canada**

GRUNDFOS Canada inc.  
2941 Brighton Road  
Oakville, Ontario  
L6H 6C9  
Tel.: +1-905 829 9533  
Fax: +1-905 829 9512

**Mexico**

Bombas GRUNDFOS de México  
S.A. de C.V.  
Boulevard TLC No. 15  
Parque industrial Stiva Aeropuerto  
Apodaca, N.L. 66600  
Tel.: +52-81-8144 4000  
Fax: +52-81-8144 4010

**Revision Info**

Last revised on 04-2021

**92995850 03.2024**

ECM: 1390223

[www.grundfos.com](http://www.grundfos.com)

**GRUNDFOS** 

Trademarks displayed in this material, including but not limited to Grundfos and the Grundfos logo, are registered trademarks owned by The Grundfos Group. © 2024 Grundfos Holding AS, all rights reserved.