

# SP

## Stainless steel submersible pumps

6", 8", and 10"

### Installation and operating instructions

US



# LIMITED WARRANTY

US

Products manufactured by GRUNDFOS PUMPS CORPORATION (Grundfos) are warranted to the original user only to be free of defects in material and workmanship for a period of 18 months from date of installation, but not more than 24 months from date of manufacture. Grundfos' liability under this warranty shall be limited to repairing or replacing at Grundfos' option, without charge, F.O.B. Grundfos' factory or authorized service station, any product of Grundfos' manufacture. Grundfos will not be liable for any costs of removal, installation, transportation, or any other charges which may arise in connection with a warranty claim. Products which are sold but not manufactured by Grundfos are subject to the warranty provided by the manufacturer of said products and not by Grundfos' warranty. Grundfos will not be liable for damage or wear to products caused by abnormal operating conditions, accident, abuse, misuse, unauthorized alteration or repair, or if the product was not installed in accordance with Grundfos' printed installation and operating instructions.

To obtain service under this warranty, the defective product must be returned to the distributor or dealer of Grundfos' products from which it was purchased together with proof of purchase and installation date, failure date, and supporting installation data. Unless otherwise provided, the distributor or dealer will contact Grundfos or an authorized service station for instructions. Any defective product to be returned to Grundfos or a service station must be sent freight prepaid; documentation supporting the warranty claim and/or a Return Material Authorization must be included if so instructed.

**GRUNDFOS WILL NOT BE LIABLE FOR ANY INCIDENTAL OR CONSEQUENTIAL DAMAGES, LOSSES, OR EXPENSES ARISING FROM INSTALLATION, USE, OR ANY OTHER CAUSES. THERE ARE NO EXPRESS OR IMPLIED WARRANTIES, INCLUDING MERCHANTABILITY OR FITNESS FOR A PARTICULAR PURPOSE, WHICH EXTEND BEYOND THOSE WARRANTIES DESCRIBED OR REFERRED TO ABOVE.**

Some jurisdictions do not allow the exclusion or limitation of incidental or consequential damages and some jurisdictions do not allow limit actions on how long implied warranties may last. Therefore, the above limitations or exclusions may not apply to you. This warranty gives you specific legal rights and you may also have other rights which vary from jurisdiction to jurisdiction.

## CONTENTS

|   | Page      |
|---|-----------|
| <b>1. Product introduction</b>  | <b>3</b>  |
| 1.1 Symbols used in this document   | 3         |
| 1.2 Introduction  | 3         |
| 1.3 Delivery and handling   | 3         |
| 1.4 Applications  | 4         |
| 1.5 Features and benefits   | 4         |
| 1.6 Identification  | 4         |
| <b>2. Operating conditions</b>  | <b>4</b>  |
| <b>3. Installation</b>  | <b>4</b>  |
| 3.1 Pre-installation checklist  | 4         |
| 3.2 Preparation   | 4         |
| 3.3 Splicing the motor cable  | 6         |
| 3.4 Riser pipe  | 7         |
| 3.5 Electrical  | 8         |
| <b>4. Startup</b>   | <b>11</b> |
| 4.1 Startup with three-phase motors                                       | 11        |
| <b>5. Operation</b>   | <b>12</b> |
| <b>6. Troubleshooting</b>   | <b>12</b> |
| 6.1 Preliminary tests   | 13        |
| 6.2 Checking pump performance   | 14        |
| 6.3 Troubleshooting chart   | 15        |
| <b>7. Technical data</b>  | <b>19</b> |
| 7.1 Minimum water flow requirements for submersible pump motors           | 19        |
| 7.2 Guide for engine-driven generators in submersible pump applications   | 19        |
| 7.3 Transformer capacity required for three-phase submersible pump motors | 20        |
| 7.4 Submersible pump cable selection chart (60 Hz)                        | 21        |
| 7.5 Three-phase motor maximum cable length                                | 22        |
| 7.6 Electrical data   | 24        |
| <b>8. Disposal</b>  | <b>26</b> |
| <b>9. Removal and fitting of cable guard</b>                              | <b>27</b> |

### Warning

*Prior to installation, read these installation and operating instructions. Installation and operation must comply with local regulations and accepted codes of good practice.*

*This booklet should be left with the owner of the pump for future reference and information regarding its operation.*



### Warning

*The use of this product requires experience with and knowledge of the product. Persons with reduced physical, sensory or mental capabilities must not use this product, unless they are under supervision or have been instructed in the use of the product by a person responsible for their safety.*

*Children must not use or play with this product.*



US

## 1. Product introduction

### 1.1 Symbols used in this document

#### Warning

*If these safety instructions are not observed, it may result in personal injury!*



*If these safety instructions are not observed, it may result in malfunction or damage to the equipment!*

Caution

*Notes or instructions that make the job easier and ensure safe operation.*

Note

### 1.2 Introduction

Your Grundfos SP submersible pump is of the utmost quality. Combined with proper installation, your Grundfos pump will give you many years of reliable service.

To ensure the proper installation of the pump, carefully read the complete manual before attempting to install the pump.

### 1.3 Delivery and handling

#### 1.3.1 Delivery

*The pumps should remain in the packing until they are placed in vertical position during installation.*

Caution

The shipping carton should contain:

- pump end
- motor
- cable
- control box
- nameplate.

Examine the components carefully to make sure no damage has occurred to the pump end, motor, cable or control box during shipment.

#### 1.3.2 Handling

Your Grundfos SP pump should remain in its shipping carton until it is ready to be installed. The carton is specially designed to protect it from damage.

During unpacking and prior to installation, **make sure that the pump is not dropped or mishandled.**

The motor is equipped with an electrical cable.

US

**Caution** *Under no circumstance should the electrical cable be used to support the weight of the pump.*

You will find a loose data plate with an adhesive backing with the pump. The nameplate should be completed in pen and attached to the control box.

### 1.4 Applications

Grundfos Large SP submersible pumps are suitable for:

- Groundwater supply to waterworks
- irrigation in horticulture and agriculture
- groundwater lowering (dewatering)
- pressure boosting
- industrial applications
- domestic water supply.

### 1.5 Features and benefits

- State-of-the-art hydraulics provide high efficiency and low operating costs.
- 100 % stainless steel components inside and outside for long service life.
- Sand resistant.
- Resistant to aggressive water.
- Motor burnout protection via CU 301.
- Dry-running protection.
- Monitoring, protection and communication via protection unit MP204, and remote control, R100.

### 1.6 Identification

#### 1.6.1 Type key

|  |            |          |            |          |          |          |          |          |
|--|------------|----------|------------|----------|----------|----------|----------|----------|
| <b>Example</b>                               | <b>475</b> | <b>S</b> | <b>500</b> | <b>-</b> | <b>5</b> | <b>-</b> | <b>A</b> | <b>B</b> |
| Rated flow rate in gpm                       |            |          |            |          |          |          |          |          |
| Type range                                   |            |          |            |          |          |          |          |          |
| Stainless steel parts of material            |            |          |            |          |          |          |          |          |
| S = AISI 304                                 |            |          |            |          |          |          |          |          |
| N = AISI 316                                 |            |          |            |          |          |          |          |          |
| R = AISI 904L                                |            |          |            |          |          |          |          |          |
| Hp of motor                                  |            |          |            |          |          |          |          |          |
| Number of impellers                          |            |          |            |          |          |          |          |          |
| First reduced-diameter impeller (A, B or C)  |            |          |            |          |          |          |          |          |
| Second reduced-diameter impeller (A, B or C) |            |          |            |          |          |          |          |          |

## 2. Operating conditions

|                |  |
|----------------|--|
| Flow (Q):      | Max. 1,400 gpm (318 m <sup>3</sup> /h) |
| Head (H):      | Max. 2,100 ft (640 m)                  |
| Liquid temp:   | + 32 °F to + 140 °F (0 °C to +60 °C)   |
| Install. depth | Max. 1,968 ft (599 m)                  |

## 3. Installation

### 3.1 Pre-installation checklist

Before beginning installation, the following checks should be made:

- Condition of the well
- condition of the water
- installation depth
- electrical supply
- wire cable type.

These checks are all critical for the proper installation of this submersible pump.

#### 3.1.1 Condition of the well

If the pump is to be installed in a new well, the well should be fully developed and bailed or blown free of cuttings and sand. The stainless steel construction of the Grundfos submersible make it resistant to abrasion; however, no pump, made of any material, can forever withstand the destructive wear that occurs when constantly pumping sandy water.

If this pump is used to replace an oil-filled submersible or oil-lubricated line-shaft turbine in an existing well, **the well must be blown or bailed clear of oil.**

Determine the maximum depth of the well, and the draw-down level at the pump's maximum capacity. Pump selection and setting depth should be based on this data.

The inside diameter of the well casing should be checked to ensure that it is not smaller than the size of the pump and motor.

#### 3.1.2 Pumped liquids

Submersible pumps are designed for pumping clear and cold water that is free of air and gasses and clean, thin **non-explosive** liquids without solid particles or fibers. Decreased pump performance and life expectancy can occur if the water is not cold and clear or contains air and gasses.

Maximum water temperature should not exceed +102 °F (+38 °C). Special consideration must be given to the pump and motor if it is to be used to pump water above 102 °F (+38 °C).

The Grundfos stainless steel submersible is highly resistant to the normal corrosive environment found in some water wells. If water well tests determine the water has an excessive or unusual corrosive quality, or exceeds 102 °F (+38 °C), contact your Grundfos representative for information concerning specially designed pumps for these applications.

### 3.2 Preparation

#### Warning



**Before starting work on the pump, make sure that the electricity supply has been switched off and that it cannot be accidentally switched on.**

**3.2.1 Checking of liquid in motor**

The SP submersible motors are factory-filled with a special non-poisonous liquid, which is frost-proof down to -4 °F (-20 °C).

**Note**

*The level of the liquid in the motor must be checked and the motor must be refilled, if required. Use clean water.*

**Caution**

*If frost protection is required, special Grundfos liquid must be used to refill the motor. Otherwise clean water may be used for refilling (however, never use distilled water).*

Refilling of liquid is carried out as described below.

**3.2.2 Grundfos submersible motors MS 4000 and MS 402**

The filling hole for motor liquid is placed in the following positions:

**MS 4000:** in the top of the motor.

**MS 402:** in the bottom of the motor.

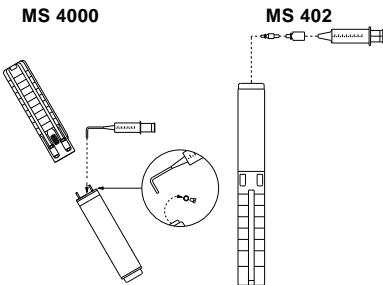
1. Position the submersible pump as shown in fig. 1.  
The filling screw must be at the highest point of the motor.
2. Remove the screw from the filling hole.
3. Inject liquid into the motor with the filling syringe, fig. 1, until the liquid runs back out of the filling hole.
4. Replace the screw in the filling hole and tighten securely before changing the position of the pump.

Torques:

**MS 4000:** 3.0 Nm.

**MS 402:** 2.0 Nm.

The submersible pump is now ready for installation.



**Fig. 1** Pump position during filling – MS 4000 and MS 402

TM00 6423 0606

**3.2.3 Grundfos submersible motors MS6 and MS 6000**

- If the motor is delivered from stock, the liquid level must be checked before the motor is fitted to the pump, see fig. 2.
- On pumps delivered directly from Grundfos, the liquid level has already been checked.

- In the case of service, the liquid level must be checked, see fig. 2.

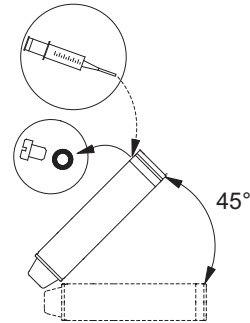
Filling procedure:

The filling hole for motor liquid is placed at the top of the motor.

1. Position the submersible pump as shown in fig. 2.  
The filling screw must be at the highest point of the motor.
2. Remove the screw from the filling hole.
3. Inject liquid into the motor with the filling syringe, fig. 2, until the liquid runs back out of the filling hole.
4. Replace the screw in the filling hole and tighten securely before changing the position of the pump.

Torque: 3.0 Nm.

The submersible pump is now ready for installation.



**Fig. 2** Motor position during filling – MS6 and MS 6000

TM05 0949 1911

**3.2.4 Grundfos submersible motors MMS 6000, MMS 8000, MMS 10000 and MMS 12000**

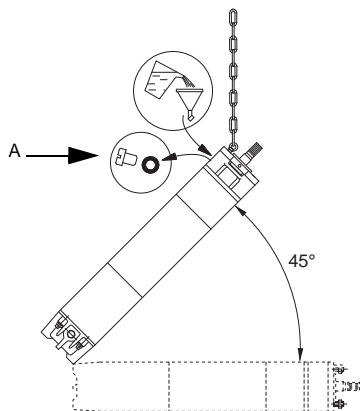
Filling procedure:

1. Place the motor at a 45 ° angle with the top of the motor upwards, see fig. 3.
2. Unscrew the plug A and place a funnel in the hole.
3. Pour tap water into the motor until the motor liquid inside the motor starts running out at A.  
**Caution:** Do not use motor liquid as it contains oil.
4. Remove the funnel and refit the plug A.

**Caution**

*Before fitting the motor to a pump after a long period of storage, lubricate the shaft seal by adding a few drops of water and turning the shaft.*

The submersible pump is now ready for installation.



**Fig. 3** Motor position during filling – MMS

TM03 0265 3605

**3.2.5 Installation depth**

A check should be made to ensure that the installation depth of the pump will always be at least (5) five to (10) ten feet (1.5 to 3 m) below the maximum draw-down level of the well. For flow rates exceeding 100 gpm (22.7 m<sup>3</sup>/h), refer to performance curves for recommended minimum submergence.

The bottom of the motor should never be installed lower than the top of the well screen or within five feet of the well bottom.

If the pump is to be installed in a lake, pond, tank or large diameter well, the water velocity passing over the motor must be sufficient to ensure proper motor cooling. The minimum recommended water flow rates which ensure proper cooling are listed in section 7.1 *Minimum water flow requirements for submersible pump motors* on p. 19.

**3.2.6 Electrical supply**

The motor voltage, phase and frequency indicated on the motor nameplate should be checked against the actual electrical supply.

**3.2.7 Wire cable type**

The wire cable used between the pump and control box or panel should be approved for submersible pump applications. The conductor may be solid or stranded. The cable may consist of individually insulated conductors twisted together, insulated conductors molded side by side in one flat cable or insulated conductors with a round overall jacket.

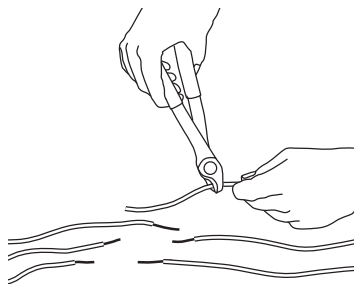
The conductor insulation should be type RW, RUW, TW, TWU or equivalent and must be suitable for use with submersible pumps. An equivalent Canadian Standards Association certified wire may also be used. See section 7.4 *Submersible pump cable selection chart (60 Hz)* on p. 21 for recommended sizes of cable lengths.

**3.3 Splicing the motor cable**

**Note** *A good cable splice is critical to proper operation of the submersible pump and must be done with extreme care.*

If the splice is carefully made, it will work as well as any other portion of the cable, and will be completely watertight. Grundfos recommends using a heat shrink splice kit. The splice should be made in accordance with the kit manufacturer's instructions. Typically a heat shrink splice can be made as follows:

1. Examine the motor cable and the drop cable carefully for damage.
2. Cut the motor leads off in a staggered manner. Cut the ends of the drop cable so that the ends match up with the motor leads; see fig. 4. On single-phase motors, be sure to match the colors.
3. Strip back and trim off 1/2 inch of insulation from each lead, making sure to scrape the wire bare to obtain a good connection. Be careful not to damage the copper conductor when stripping off the insulation.
4. Slide the heat shrink tubing on to each lead. Insert a properly sized "Sta-kon" type connector on each lead, making sure that lead colors are matched. Using a "Sta-kon" crimping pliers, indent the lugs; see fig. 5. Be sure to squeeze hard on the pliers, particularly when using large cable.
5. Center the heat shrink tubing over the connector. Using a propane torch, lighter, or electric heat gun, uniformly heat the tubing starting first in the center working towards the ends; see fig. 6.
6. Continue to apply the heat to the tubing using care not to let the flame directly contact the tubing. When the tubing shrinks and the sealant flows from the ends of the tubing, the splice is complete; see fig. 7.



**Fig. 4** Cutting and stripping the motor leads

TM05 0032 0611

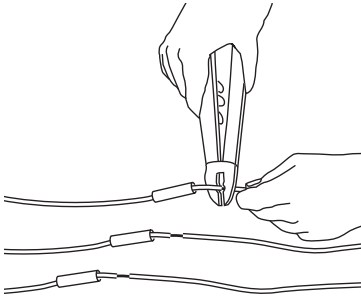


Fig. 5 Crimping the connectors

TM05 0033 0611

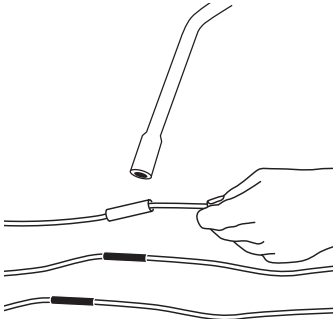


Fig. 6 Applying heat to the connector

TM05 0034 0611

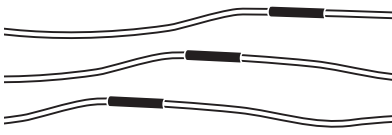


Fig. 7 Completed splices

TM05 0035 0611

### 3.4 Riser pipe

*The riser pipe or hose should be properly sized and selected based on estimated flow rates and friction-loss factors.*

Note

#### 3.4.1 If an adapter is required

It is recommended to first install the drop pipe to the pipe adapter. Then install the drop pipe with the adapter to the pump discharge.

A back-up wrench should be used when the riser pipe is attached to the pump. The pump should be gripped only by the flats on the top of the discharge chamber. The body of the pump, cable guard or motor should not be gripped under any circumstance.

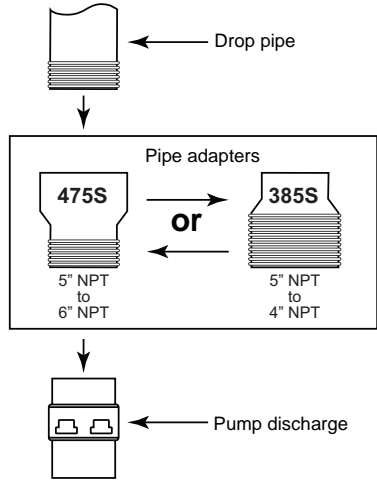


Fig. 8 Pipe adapters

TM05 0036 0611

#### 3.4.2 If steel riser pipe is used

We recommend that steel riser pipes always be used with the larger submersibles. An approved pipe thread compound should be used on all joints. Make sure the joints are adequately tightened in order to resist the tendency of the motor to loosen the joints when stopping and starting.

**When tightened, the first section of the riser pipe must not come in contact with the check valve retainer in the discharge chamber of the pump.**

After the first section of the riser pipe has been attached to the pump, the lifting cable or elevator should be clamped to the pipe. **Do not clamp the pump.**

When raising the pump and riser section, be careful not to place bending stress on the pump by picking it up by the pump end only.

**Make sure that the electrical cables are not cut or damaged in any way when the pump is being lowered in the well.**

The drop cable should be secured to the riser pipe at frequent intervals to prevent sagging, looping or possible cable damage. Nylon cable clips or waterproof tape may be used. The cable splice should be protected by securing it with clips or tape just above and below the splice.

#### 3.4.3 If plastic or flexible riser pipe is used

**It is recommended that plastic type riser pipe be used only with the smaller domestic submersibles.**

*When plastic riser pipe is used, it is recommended that a safety cable be attached to the pump to lower and raise it.*

Caution

**Warning**

**Important:** Plastic and flexible pipe tend to stretch under load. This stretching must be taken into account when securing the cable to the riser pipe. Leave 3 to 4 inches of slack between clips or taped points to allow for this stretching. This tendency for plastic and flexible pipe to stretch will also affect the calculation of the pump setting depth. As a general rule, you can estimate that plastic pipe will stretch to approximately 2 % of its length. For example, if you installed 200 feet (61 m) of plastic riser pipe, the pump may actually be down 204 feet (62 m). If the depth setting is critical, check with the manufacturer of the pipe to determine who to compensate for pipe stretch.

Note

The pipe manufacturer or representative should be contacted to insure the pipe type and physical characteristics are suitable for this use.

Use the correct joint compound recommended by the pipe manufacturer. In addition to making sure that joints are securely fastened, the use of a torque arrester is recommended when using plastic pipe.

Do not connect the first plastic or flexible riser section directly to the pump. Always attach a metallic nipple or adapter into the discharge chamber of the pump. When tightened, the threaded end of the nipple or adapter must not come in contact with the check valve retainer in the discharge chamber of the pump.

The drop cable should be secured to the riser pipe at frequent intervals to prevent sagging, looping and possible cable damage. Nylon cable clips or waterproof tape may be used. The cable splice should be protected by securing it with clips or tape just above each joint.

**Check valves:**

A check valve should always be installed at the surface of the well. In addition, for installations deeper than 200 feet (61 m), check valves should be installed at no more than 200 foot (61 m) intervals.

**Protect the well from contamination:**

To protect against surface water entering the well and contaminating the water source, the well should be finished off above grade, and a locally approved well seal or pitless adapter unit utilized.

**3.5 Electrical**

**Warning**



**USA:** All electrical work should be performed by a qualified electrician and installed in accordance with the National Electrical Code, local codes and regulations.

**Warning**



**Canada:** All electrical work should be performed by a qualified electrician and installed in accordance with the Canadian Electrical Code, local codes and regulations.

**Warning**



To reduce the risk of electrical shock during operation of this pump requires the provision of acceptable grounding. If the means of connection to the supply connected box is other than grounded metal conduit, ground the pump back to the service by connecting a copper conductor, at least the size of the circuit supplying the pump, to the grounding screw provided within the wiring compartment.

Verification of the electrical supply should be made to ensure the voltage, phase and frequency match that of the motor. Motor voltage, phase, frequency and full-load current information can be found on the nameplate attached to the motor. Motor electrical data can be found in section 7.6.1 Grundfos submersible pump motors - 60 Hz on p. 24.



**Warning**

**If voltage variations are larger than +/-10%, do not operate the pump.**

Direct on-line starting is used due to the extremely fast run-up time of the motor (0.1 second maximum), and the low moment of inertia of the pump and motor. Direct on-line starting current (locked rotor amp) is between 4 and 6.5 times the full-load current.

If direct on-line starting is not acceptable and reduced starting current is required, an autotransformer or resistor starters should be used for 5 to 30 Hp motors (depending on cable length). For motors over 30 Hp, use auto-transformer starters.

**3.5.1 Engine-driven generators**

If the submersible pump is going to be operated using an engine driven generator, we suggest the manufacturer of the generator be contracted to ensure the proper generator is selected and used. See section 7.2 *Guide for engine-driven generators in submersible pump applications* on p. 19 for generator sizing guide.

If power is going to be supplied through transformers, section 7.3 *Transformer capacity required for three-phase submersible pump motors* on p. 20 outlines the minimum KVA rating and capacity required for satisfactory pump operation.

**3.5.2 Control box/panel wiring**

**Single-phase motors**

Single-phase motors must be connected as indicated in the motor control box.

A typical single-phase wiring diagram using a Grundfos control box is shown in fig 9.

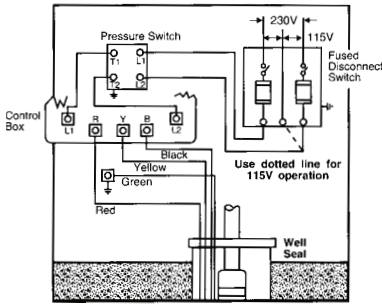


Fig. 9 Single-phase wiring diagram for Grundfos control boxes

TM05 0037 0611

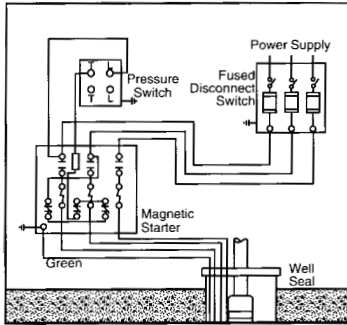


Fig. 10 Three-phase wiring diagram for Grundfos and Franklin motors

TM05 0038 0611

**Three-phase motors**

Three-phase motors must be used with the proper size and type of motor starter to ensure the motor is protected against damage from low voltage, phase failure, current unbalance and overload current.

A properly sized starter with ambient-compensated extra quick-trip overloads must be used to give the best possible motor winding protection.

**Each of the three motor legs must be protected with overloads.** The thermal overloads must trip in less than 10 seconds at locked rotor (starting) current. A three-phase motor wiring diagram is shown in fig. 10.

*Pumps should NEVER be started to check rotation unless the pump is totally submerged. Severe damage may be caused to the pump and motor if they are run dry.*

**Caution**

**3.5.3 High voltage surge arresters**

A high voltage surge arrester should be used to protect the motor against lightning and switching surges.

Lightning voltage surges in power lines are caused when lightning strikes somewhere in the area.

Switching surges are caused by the opening and closing of switches on the main high-voltage distribution power lines.

The correct voltage-rated surge arrester should be installed on the supply (line) side of the control box; see fig. 11 and fig. 12. The arrester must be grounded in accordance with the National Electrical Code and local codes and regulations.

**US**

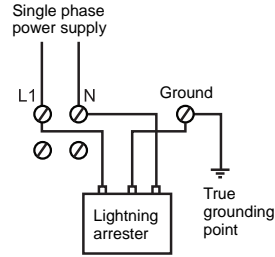


Fig. 11 Single-phase hookup

TM05 0039 0611

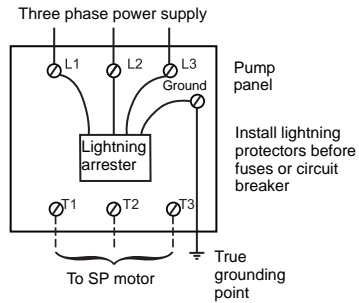


Fig. 12 Three-phase hookup

TM05 0040 0611

**The warranty on all three-phase submersible motors is VOID if:**

1. The motor is operated with single-phase power through a phase converter.
2. Three-leg ambient compensated extra quick-trip overload protectors are not used.
3. Three-phase current unbalance is not checked and recorded; see section 4. Startup on p. 11.
4. High voltage surge arresters are not installed.

**Note**

**3.5.4 Control box/panel grounding**

**Warning**

*The control box or panel shall be permanently grounded in accordance with the National Electrical Code and local codes or regulations.*



The ground wire should be a bare copper conductor at least the same size as the drop cable wire size.

The ground wire should be run as short a distance as possible and be securely fastened to a true grounding point.

True grounding points are considered to be:

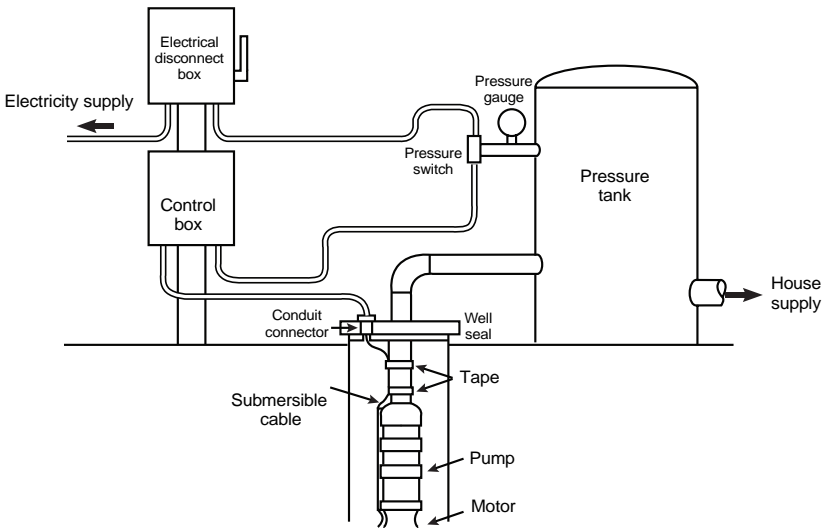
- a grounding rod driven into the water strata
- steel well casing submerged into the water lower than the pump setting level
- steel discharge pipes without insulating couplings.

If plastic discharge pipe and well casing are used or if a grounding wire is required by local codes, a properly sized bare copper wire should be connected to a stud on the motor and run to the control panel.

**Warning**



**Do not ground to a gas supply line. Connect the grounding wire to the ground point first and then to the terminal in the control box or panel.**



**Fig. 13** Wiring and installation diagram

**3.5.5 Wiring checks and installation**

Before making the final surface wiring connection of the drop cable to the control box or panel, it is a good practice to check the insulation resistance to ensure that the cable and splice are good. Measurements for a new installation must be at least 2,000,000 ohm. **Do not start the pump if the measurement is less than this.**

If it is higher than 2,000,000 ohm, the drop cable should then be run through the well seal by means of a conduit connector in such a way as to eliminate any possibility of foreign matter entering the well casing.

Conduit should always be used from the pump to the control box or panel to protect the drop cable; see fig. 13.

Finish wiring and verify that all electrical connections are made in accordance with the wiring diagram.

Check to ensure the control box or panel and high voltage surge arrester have been grounded.

TM05 0041 0611

## 4. Startup

After the pump has been set into the well and the wiring connections have been made, the following procedures should be performed:

1. Attach a temporary horizontal length of pipe with installed gate valve to the riser pipe.
2. Adjust the gate valve one-third of the way open.
3. On three-phase units, check direction of rotation and current unbalance according to the instructions below. For single-phase units proceed directly to 4.1.3 *Developing the well* on p. 11.
4. Under no circumstances should the pump be operated for any prolonged period of time with the discharge valve closed. This can result in motor and pump damage due to overheating. A properly sized relief valve should be installed at the well head to prevent the pump from running against a closed valve.

### 4.1 Startup with three-phase motors

#### 4.1.1 Check the direction of rotation

Three-phase motors can run in either direction depending on how they are connected to the power supply. When the three cable leads are first connected to the power supply, there is a 50 % chance that the motor will run in the proper direction. To make sure the motor is running in the proper direction, carefully follow these procedures:

1. Start the pump and check the water quantity and pressure developed.
2. Stop the pump and interchange any two leads.
3. Start the pump and again check the water quantity and pressure.
4. Compare the results observed. The wire connection which gave the highest pressure and largest water quantity is the correct connection.

#### 4.1.2 Check for current unbalance

Current unbalance causes the motor to have reduced starting torque, overload tripping, excessive vibration and poor performance which can result in early motor failure. It is very important that current unbalance be checked in all three-phase systems. **Current unbalance between the legs should not exceed 5 % under normal operating conditions.**

The supply power service should be verified to see if it is a two or three transformer system. If two transformers are present, the system is an "open" delta or wye. If three transformers are present, the system is true three-phase.

**Make sure the transformer ratings in kilovolt amps (KVA) is sufficient for the motor load; see section 7.3 Transformer capacity required for three-phase submersible pump motors on p. 20.**

The percentage of current unbalance can be calculated by using the following formulas and procedures:

$$\text{Average current} = \frac{\text{Total of current values measured on each leg}}{3}$$

$$\% \text{ Current unbalance} = \frac{\text{Greatest amp difference from the average}}{\text{average current}} \times 100$$

To determine the percentage of current unbalance:

1. Measure and record current readings in amps for each leg (Hookup 1). Disconnect power.
2. Shift or roll the motor leads from left to right so the drop cable lead that was on terminal 1 is now on 2, lead on 2 is now on 3, and lead on 3 is now on 1 (Hookup 2). Rolling the motor leads in this manner will not reverse the motor rotation. Start the pump, measure and record current reading on each leg. Disconnect power.
3. Again shift drop cable leads from left to right so the lead on terminal 1 goes to 2, 2 to 3 and 3 to 1 (Hookup 3). Start pump, measure and record current reading on each leg. Disconnect power.
4. Add the values for each hookup.
5. Divide the total by 3 to obtain the average.
6. Compare each single leg reading from the average to obtain the greatest amp difference from the average.
7. Divide this difference by the average to obtain the percentage of unbalance.

Use the wiring hookup which provides the lowest percentage of unbalance. See section 7.6.4 *Correcting for three-phase power imbalance* on p. 25 for a specific example of correcting for three-phase power unbalance.

#### 4.1.3 Developing the well

After proper rotation and current unbalance have been checked, start the pump and let it operate until the water runs clear of sand, silt and other impurities.

Slowly open the valve in small increments as the water clears until the desired flow rate is reached. Do not operate the pump beyond its maximum flow rating. **The pump should not be stopped until the water runs clear.**

If the water is clean and clear when the pump is first started, the valve should still be **slowly opened until the desired flow rate is reached.** As the valve is being opened, the drawdown should be checked to ensure the pump is always submerged. **The dynamic water level should always be more than 3 feet (0.9 m) above the inlet strainer of the pump.**

Disconnect the temporary piping arrangements and complete the final piping connections.

## Caution

**Warning**

***Under no circumstances should the pump be operated for any prolonged period of time with the discharge valve closed. This can result in motor and pump damage due to overheating. A properly sized relief valve should be installed at the well head to prevent the pump from running against a closed valve.***

Start the pump and test the system. Check and record the voltage and current draw on each motor lead.

**5. Operation**

The pump and system should be periodically checked for water quantity, pressure, drawdown, periods of cycling and operation of controls.

If the pump fails to operate, or there is a loss of performance, refer to section 6. *Troubleshooting* on p. 12.

**6. Troubleshooting**

The majority of problems that develop with submersible pumps are electrical, and most of these problems can be corrected without pulling the pump from the well. The following chart covers most of the submersible service work. As with any troubleshooting procedure, start with the simplest solution first; always make all the above ground checks before pulling the pump from the well.

Usually only two instruments are needed:

- a combination voltmeter/ammeter
- an ohmmeter.

These are relatively inexpensive and can be obtained from most water systems suppliers.

**Warning**

***WHEN WORKING WITH ELECTRICAL CIRCUITS, USE CAUTION TO AVOID ELECTRICAL SHOCK.***



***It is recommended that rubber gloves and boots be worn and that care is taken to have metal control boxes and motors grounded to power supply ground or steel drop pipe or casing extending into the well.***

**Warning**

***Submersible motors are intended for operation in a well. When not operated in a well, failure to connect motor frame to power supply ground may result in serious electrical shock.***



## 6.1 Preliminary tests

US

| Test                  | How to measure  | What it means   |
|-----------------------|---|---|
| Supply voltage        | <p>By means of a voltmeter, which has been set to the proper scale, measure the voltage at the control box or starter.</p> <ul style="list-style-type: none"> <li>• <b>On single-phase units</b>, measure between line and neutral.</li> <li>• <b>On three-phase units</b>, measure between the legs (phases).</li> </ul>   | <p>When the motor is under load, the voltage should be within <math>\pm 10\%</math> of the nameplate voltage. Larger voltage variation may cause winding damage.</p> <p>Large variations in the voltage indicate a poor electrical supply and the pump should not be operated until these variations have been corrected. If the voltage constantly remains high or low, the motor should be changed to the correct supply voltage.</p>   |
| Current               | <p>By use of an ammeter, set on the proper scale, measure the current on each power lead at the control box or starter. See section 7.6 <i>Electrical data</i> on p. 24 for motor amp draw information.</p> <ul style="list-style-type: none"> <li>• Current should be measured when the pump is operating at a constant discharge pressure with the motor fully loaded.</li> </ul>   | <p>If the amp draw exceeds the listed service factor amps (SFA) or if the current unbalance is greater than 5 % between each leg on three-phase units, check for the following:</p> <ul style="list-style-type: none"> <li>• Burnt contacts on motor starter.</li> <li>• Loose terminals in starter or control box or possible cable defect. Check winding and insulation resistances.</li> <li>• Supply voltage too high or low.</li> <li>• Motor windings are shorted.</li> <li>• Pump is damaged, causing a motor overload.</li> </ul> |
| Winding resistance    | <ul style="list-style-type: none"> <li>• Turn off power and disconnect the drop cable leads in the control box or starter.</li> <li>• Using an ohmmeter, set the scale selectors to Rx1 for values under 10 ohms and Rx10 for values over 10 ohms.</li> <li>• Zero-adjust the meter and measure the resistance between leads. Record the values.</li> <li>• Motor resistance values can be found in section 7.6 <i>Electrical data</i> on p. 24. Cable resistance values are in section 7.6.5 <i>Total resistance of drop cable (OHMS)</i> on p. 26.</li> </ul> | <p>If all the ohm values are normal, and the cable colors correct, the windings are not damaged.</p> <p>If any one ohm value is less than normal, the motors may be shorted.</p> <p>If any one ohm value is greater than normal, there is a poor cable connection or joint. The windings or cable may also be open.</p> <p>If some of the ohm values are greater than normal and some less, the drop cable leads are mixed. To verify lead colors, see resistance values in section 7.6 <i>Electrical data</i> on p. 24.</p>              |
| Insulation resistance | <ul style="list-style-type: none"> <li>• Turn off power and disconnect the drop cable leads in the control box or starter.</li> <li>• Using an ohm or mega ohmmeter, set the scale selector to Rx 100K and zeroadjust the meter.</li> <li>• Measure the resistance between the lead and ground (discharge pipe or well casing, if steel).</li> </ul>  | <p>For ohm values, refer to section 6.1.1 <i>Ohm value chart</i> on p. 14.</p> <p>Motors of all hp, voltage, phase and cycle duties have the same value of insulation resistance.</p>   |

### 6.1.1 Ohm value chart

| Ohm value chart   |                     |               |   |
|---|---------------------|---------------|---|
|   | Ohm value           | Megaohm value | Condition of motor and leads/<br>recommended procedure  |
| Motor not yet installed                                       | 2,000,000 (or more) | 2.0           | New motor.  |
|   | 1,000,000 (or more) | 1.0           | Used motor which can be reinstalled in the well.  |
|   | 500,000 - 1,000,000 | 0.5 - 1.0     | A motor in reasonably good condition.   |
|   | 20,000 - 500,000    | 0.02 - 0.5    | A motor which may have been damaged by lightning or with damaged leads. Do not pull the pump for this reason.   |
| Motor in well<br>(Ohm readings are for drop cable plus motor) | 10,000 - 20,000     | 0.01 - 0.02   | A motor which definitely has been damaged or with damaged cable.<br><br>The pump should be pulled and repairs made to the cable or the motor replaced. The motor will still operate, but probably not for long. |
|   |                     |               | A motor which has failed or with completely destroyed cable insulation.   |
|   | Less than 10,000    | 0 - 0.01      | The pump must be pulled and the cable repaired or the motor replaced. The motor will not run in this condition.   |

### 6.2 Checking pump performance

The troubleshooting chart on p.15 may require that you test the pump's performance against its curve. To do so, perform these steps:

1. Install pressure gauge
2. Start pump
3. Gradually close the discharge valve
4. Read pressure at shut-off.
5. After taking reading, open valve to its previous position.
6. To calculate pump performance, first convert psi reading to feet.  
(For water:  $\text{PSI} \times 2.31 = \text{ft.}$ )
7. Add this to the total vertical distance from the pressure gauge to the water level in the well while the pump is running.
8. Refer to the specific pump curve for the shut-off head for that pump model. If the measured head is close to the curve, pump is probably OK.

### 6.3 Troubleshooting chart

| Problem               | Possible cause/how to check  | Possible remedy  |
|-----------------------|--|--|
| 1. Pump does not run. | a) No power at pump panel.<br><br>How to check:<br>Check for voltage at panel.   | If no voltage at panel, check feeder panel for tripped circuits.   |
|                       | b) Fuses are blown or circuit breakers are tripped.<br><br>How to check:<br>Remove fuses and check for continuity with ohmmeter.   | Replace blown fuses or reset circuit breaker. If new fuses blow or circuit breaker trips, the electrical installation and motor must be checked. |
|                       | c) Motor starter overloads are burnt or have tripped out (three-phase only).<br><br>How to check:<br>Check for voltage on line or load side of starter.  | Replace burnt heaters or reset. Inspect starter for other damage. If heater trips again, check the supply voltage and starter holding coil.      |
|                       | d) Starter does not energize (three-phase only).<br><br>How to check:<br>Energize control circuit and check for voltage at the holding coil.   | If no voltage, check control circuit. If voltage, check holding coil for shorts. Replace bad coil.   |
|                       | e) Defective controls.<br><br>How to check:<br>Check all safety and pressure switches for operation. Inspect contacts in control devices.  | Replace worn or defective parts.   |
|                       | f) Motor and/or cable are defective.<br><br>How to check:<br>Turn off power. Disconnect motor leads from control box. Measure the lead-tolead resistances with the ohmmeter (Rx1). Measure lead-to-ground values with ohmmeter (Rx100K). Record measured values. | If open motor winding or ground is found, remove pump and recheck values at the surface. Repair or replace motor or cable.                       |
|                       | g) Defective capacitor (single-phase only).<br><br>How to check:<br>Turn off the power, then discharge capacitor. Check with an ohmmeter (Rx100K). When meter is connected, the needle should jump forward and slowly drift back.                                | If there is no ohmmeter needle movement, replace the capacitor.  |

| <b>Problem</b>                           | <b>Possible cause/how to check</b>  | <b>Possible remedy</b>   |
|--|---|--|
| 2. Pump runs but does not deliver water. | a) Groundwater level in well is too low or well is collapsed.<br><br>How to check:<br>Check well draw-down. Water level should be at least 3 ft. above pump inlet during operation. | If water level is not at least 3 ft. above pump inlet during operation, then lower the pump if possible, or throttle discharge valve and install water level control.  |
|  | b) Integral pump check valve is blocked.<br><br>How to check:<br>Check the pump's performance against its curve; see section 6.2 <i>Checking pump performance</i> on page 14.       | If the pump is not operating close to the pump curve, remove pump and inspect discharge section. Remove blockage, repair valve and valve seat if necessary. Check for other damage. Rinse out pump and re-install. |
|  | c) Inlet strainer is clogged.<br><br>How to check:<br>Check the pump's performance against its curve; see section 6.2 <i>Checking pump performance</i> on page 14.                  | If pump is not operating close to the pump curve, remove pump and inspect. Clean strainer, inspect integral check valve for blockage, rinse out pump and re-install.   |
|  | d) Pump is damaged.<br><br>How to check:<br>Check the pump's performance against its curve; see section 6.2 <i>Checking pump performance</i> on page 14.                            | If pump is damaged, repair as necessary. Rinse out pump and re-install.  |
| 3. Pump runs but at reduced capacity.    | a) Wrong rotation (three phase only).<br><br>How to check:<br>Check for proper electrical connection in control panel.  | Correct wiring and change leads as required.   |
|  | b) Draw-down is larger than anticipated.<br><br>Check draw-down during pump operation.  | Lower the pump if possible. If not, throttle discharge valve and install water level control.  |
|  | c) Discharge piping or valve leaking.<br><br>How to check:<br>Examine system for leaks.   | Repair leaks.  |
|  | d) Pump strainer or check valve are clogged.<br><br>How to check:<br>Check the pump's performance against its curve; see section 6.2 <i>Checking pump performance</i> on page 14.   | If not close to the pump curve, remove pump and inspect. Clean strainer, inspect integral check valve for blockage, rinse out pump and re-install.   |
|  | e) Pump is worn.<br><br>How to check:<br>Check the pump's performance against its curve; see section 6.2 <i>Checking pump performance</i> on page 14.                               | If not close to pump curve, remove pump and inspect.   |

| <b>Problem</b>                         | <b>Possible cause/how to check</b>  | <b>Possible remedy</b>   |
|--|---|--|
| 4. Pump cycles too much.               | a) Pressure switch is not properly adjusted or is defective.<br><br>How to check:<br>Check pressure setting on switch and operation. Check voltage across closed contacts.  | Re-adjust switch or replace if defective.  |
|  | b) Level control is not properly set or is defective.<br><br>How to check:<br>Check setting and operation.  | Re-adjust setting (refer to manufacturer data.) Replace if defective.                        |
|  | c) Insufficient air charging or leaking tank or piping.<br><br>How to check:<br>Pump air into tank or diaphragm chamber. Check diaphragm for leak. Check tank and piping for leaks with soap and water solution. Check air to water volume. | Repair or replace damaged component.   |
|  | d) Plugged snifter valve or bleed orifice.<br><br>How to check:<br>Examine valve and orifice for dirt or corrosion.   | Clean and/or replace snifter valve or bleed orifice if defective.                            |
|  | e) Tank is too small.<br><br>How to check:<br>Check tank size. Tank volume should be approximately 10 gallons for each gpm or pump capacity.  | If tank is too small, replace with proper size tank.   |
| 5. Fuses blow or circuit breakers trip | a) High or low voltage.<br><br>How to check:<br>Check voltage at pump panel. If not within $\pm 10\%$ , check wire size and length of run to pump panel.  | If wire size is correct, contact power company. If not, correct and/or replace as necessary. |
|  | b) Three-phase current unbalance.<br><br>How to check:<br>Check current draw on each lead. Unbalance must be within $\pm 5\%$ .   | If current unbalance is not within $\pm 5\%$ , contact power company.                        |
|  | c) Control box wiring and components (single-phase only).<br><br>How to check:<br>Check that control box parts match the parts list. Check to see that wiring matches wiring diagram. Check for loose or broken wires or terminals.         | Correct as required.   |

| <b>Problem</b>                                  | <b>Possible cause/how to check</b>   | <b>Possible remedy</b>  |
|---|--|---|
| 5. Fuses blow or circuit breakers trip (con't). | d) Defective capacitor (single-phase only).<br><br>How to check:<br>Turn off power and discharge capacitor. Check using an ohmmeter (Rx100K). When the meter is connected, the needle should jump forward and slowly drift back. | If there is no ohmmeter needle movement, replace the capacitor. |
|   | e) Starting relay (Franklin single-phase motors only).<br><br>How to check:<br>Check resistance of relay coil with an ohmmeter (Rx1000K). Check contacts for wear.   | Replace defective starting relay.                               |

## 7. Technical data

### 7.1 Minimum water flow requirements for submersible pump motors

| Motor diameter | Casing or sleeve I.D. [inches] | Min. flow past the motor [gpm] |
|----------------|--------------------------------|--------------------------------|
| 4"             | 4                              | 1.2                            |
|                | 5                              | 7                              |
|                | 6                              | 13                             |
|                | 7                              | 21                             |
|                | 8                              | 30                             |
| 6"             | 6                              | 10                             |
|                | 7                              | 28                             |
|                | 8                              | 45                             |
|                | 10                             | 85                             |
|                | 12                             | 140                            |
|                | 14                             | 198                            |
|                | 16                             | 275                            |
| 8"             | 8                              | 10                             |
|                | 10                             | 55                             |
|                | 12                             | 110                            |
|                | 14                             | 180                            |
|                | 16                             | 255                            |
| 10"            | 10                             | 30                             |
|                | 12                             | 85                             |
|                | 14                             | 145                            |
|                | 16                             | 220                            |
|                | 18                             | 305                            |

#### Notes:

- A flow inducer or sleeve must be used if the water enters the well above the motor or if there is insufficient water flow past the motor.
- The minimum recommended water velocity over 4" motors is 0.25 feet (0.08 m) per second.
- The minimum recommended water velocity over 6", 8", and 10" motors is 0.5 (0.15 m) feet per second.

### 7.2 Guide for engine-driven generators in submersible pump applications

| Motor - 1 or 3 ph [hp] | Generator [kW]       |                      |
|------------------------|----------------------|----------------------|
|                        | Externally regulated | Internally regulated |
| 0.33                   | 1.5                  | 1.2                  |
| 0.5                    | 2.0                  | 1.5                  |
| 0.75                   | 3.0                  | 2.0                  |
| 1                      | 4.0                  | 2.5                  |
| 1.5                    | 5.0                  | 3.0                  |
| 2                      | 7.5                  | 4.0                  |
| 3                      | 10.0                 | 5.0                  |
| 5.0                    | 15.0                 | 7.5                  |
| 7.5                    | 20.0                 | 10.0                 |
| 10.0                   | 30.0                 | 15.0                 |
| 15.0                   | 40.0                 | 20.0                 |
| 20.0                   | 60.0                 | 25.0                 |
| 25.0                   | 75.0                 | 30.0                 |
| 30.0                   | 100.0                | 40.0                 |
| 40.0                   | 100.0                | 50.0                 |
| 50.0                   | 150.0                | 60.0                 |
| 60.0                   | 175.0                | 75.0                 |
| 75.0                   | 250.0                | 100.0                |
| 100.0                  | 300.0                | 150.0                |
| 125.0                  | 375.0                | 175.0                |
| 150.0                  | 450.0                | 200.0                |
| 200.0                  | 600.0                | 275.0                |

#### Notes:

- Table is based on typical 176 °F (80 °C) rise continuous duty generators with 35 % maximum voltage dip during start-up of single-phase and three-phase motors.
- Contact the manufacturer of the generator to assure the unit has adequate capacity to run the submersible motor.
- If the generator rating is in KVA instead of kilowatts, multiply the above ratings by 1.25 to obtain KVA.

### 7.3 Transformer capacity required for three-phase submersible pump motors

US

| 3-phase motor [hp] | Minimum total KVA required* | Minimum KVA rating for each transformer |                             |
|--------------------|-----------------------------|---|-----------------------------|
|                    |                             | 2 transformers Open Delta or Wye        | 3 transformers Delta or Wye |
| 1.5                | 3                           | 2                                       | 1                           |
| 2                  | 4                           | 2                                       | 1.5                         |
| 3                  | 5                           | 3                                       | 2                           |
| 5                  | 7.5                         | 5                                       | 3                           |
| 7.5                | 10                          | 7.5                                     | 5                           |
| 10                 | 15                          | 10                                      | 5                           |
| 15                 | 20                          | 15                                      | 7.5                         |
| 20                 | 25                          | 15                                      | 10                          |
| 25                 | 30                          | 20                                      | 10                          |
| 30                 | 40                          | 25                                      | 15                          |
| 40                 | 50                          | 30                                      | 20                          |
| 50                 | 60                          | 35                                      | 20                          |
| 60                 | 75                          | 40                                      | 25                          |
| 75                 | 90                          | 50                                      | 30                          |
| 100                | 120                         | 65                                      | 40                          |
| 125                | 150                         | 85                                      | 50                          |
| 150                | 175                         | 100                                     | 60                          |
| 200                | 230                         | 130                                     | 75                          |

**Notes:**

- Pump motor KVA requirements only, and does not include allowances for other loads.

### 7.4 Submersible pump cable selection chart (60 Hz)

The following tables list the recommended copper cable sizes and various cable lengths for submersible pump motors.

These tables comply with the 1978 edition of the National Electric Table 310-16, Column 2 for 167 °F (75 °C) wire. The ampacity (current carrying properties of a conductor) have been divided by 1.25 per the N.E.C., Article 430-22, for motor branch circuits based on motor amps at rated horsepower.

To assure adequate starting torque, the maximum cable lengths are calculated to maintain 95 % of the service entrance voltage at the motor when the motor is running at maximum nameplate amps. Cable sizes larger than specified may always be used and will reduce power usage.

***The use of cables smaller than the recommended sizes will void the warranty. Smaller cable sizes will cause reduced starting torque and poor motor operation.***

**Caution**

Single-phase motor maximum cable length [ft]  
(Motor to service entrance) (2)

| Volts | Hp  | Max. cable length [ft] | Wire size |     |      |      |      |      |      |      |      |      |      |     |     |  |
|-------|-----|------------------------|-----------|-----|------|------|------|------|------|------|------|------|------|-----|-----|--|
|       |     |                        | 14        | 12  | 10   | 8    | 6    | 4    | 2    | 0    | 00   | 000  | 0000 | 250 | 300 |  |
| 115   | .33 |                        | 130       | 210 | 340  | 540  | 840  | 1300 | 1960 | 2910 |      |      |      |     |     |  |
|       | .5  |                        | 100       | 160 | 250  | 390  | 620  | 960  | 1460 | 2160 |      |      |      |     |     |  |
|       | .33 |                        | 550       | 880 | 1390 | 2190 | 3400 | 5250 | 7960 |      |      |      |      |     |     |  |
|       | .5  |                        | 400       | 650 | 1020 | 1610 | 2510 | 3880 | 5880 |      |      |      |      |     |     |  |
|       | .75 |                        | 300       | 480 | 760  | 1200 | 1870 | 2890 | 4370 | 6470 |      |      |      |     |     |  |
| 230   | 1   |                        | 250       | 400 | 630  | 990  | 1540 | 2380 | 3610 | 5360 | 6520 |      |      |     |     |  |
|       | 1.5 |                        | 190       | 310 | 480  | 770  | 1200 | 1870 | 2850 | 4280 | 5240 |      |      |     |     |  |
|       | 2   |                        | 150       | 250 | 390  | 620  | 970  | 1530 | 2360 | 3620 | 4480 |      |      |     |     |  |
|       | 3   |                        | 120       | 190 | 300  | 470  | 750  | 1190 | 1850 | 2890 | 3610 |      |      |     |     |  |
|       | 5   |                        |           |     | 180  | 280  | 450  | 710  | 1110 | 1740 | 2170 |      |      |     |     |  |
|       | 7.5 |                        |           |     |      | 200  | 310  | 490  | 750  | 1140 | 1410 |      |      |     |     |  |
|       | 10  |                        |           |     |      |      |      | 250  | 390  | 600  | 930  | 1160 |      |     |     |  |

**Notes:**

1. If aluminum conductor is used, multiply lengths by 0.5. Maximum allowable length of aluminum is considerably shorter than copper wire of same size.
2. The portion of the total cable which is between the service entrance and a 3Ø motor starter should not exceed 25 % of the total maximum length to assure reliable starter operation. Single-phase control boxes may be connected at any point of the total cable length.
3. Cables #14 to #0000 are AWG sizes, and 250 to 300 are MCM sizes.

## 7.5 Three-phase motor maximum cable length

**Caution** Use of wire size smaller than listed will void warranty.

|       |     | Three-phase motor maximum cable length [ft]<br>(Motor to service entrance) (2) |      |      |      |      |      |      |      |      |      |      |      |      |
|-------|-----|--|------|------|------|------|------|------|------|------|------|------|------|------|
| Volts | Hp  | Wire size  |      |      |      |      |      |      |      |      |      |      |      |      |
|       |     | 14   | 12   | 10   | 8    | 6    | 4    | 2    | 0    | 00   | 000  | 0000 | 250  | 300  |
| 208   | 1.5 | 310  | 500  | 790  | 1260 |      |      |      |      |      |      |      |      |      |
|       | 2   | 240  | 390  | 610  | 970  | 1520 |      |      |      |      |      |      |      |      |
|       | 3   | 180  | 290  | 470  | 740  | 1160 | 1810 |      |      |      |      |      |      |      |
|       | 5   |  | 170  | 280  | 440  | 690  | 1080 | 1660 |      |      |      |      |      |      |
|       | 7.5 |  |      | 200  | 310  | 490  | 770  | 1180 | 1770 |      |      |      |      |      |
|       | 10  |  |      |      | 230  | 370  | 570  | 880  | 1330 | 1640 |      |      |      |      |
|       | 15  |  |      |      |      | 250  | 390  | 600  | 910  | 1110 | 1340 |      |      |      |
|       | 20  |  |      |      |      |      | 300  | 460  | 700  | 860  | 1050 | 1270 |      |      |
|       | 25  |  |      |      |      |      |      | 370  | 570  | 700  | 840  | 1030 | 1170 |      |
|       | 30  |  |      |      |      |      |      |      | 310  | 470  | 580  | 700  | 850  | 970  |
| 230   | 1.5 | 360  | 580  | 920  | 1450 |      |      |      |      |      |      |      |      |      |
|       | 2   | 280  | 450  | 700  | 1110 | 1740 |      |      |      |      |      |      |      |      |
|       | 3   | 210  | 340  | 540  | 860  | 1340 | 2080 |      |      |      |      |      |      |      |
|       | 5   |  | 200  | 320  | 510  | 800  | 1240 | 1900 |      |      |      |      |      |      |
|       | 7.5 |  |      | 230  | 360  | 570  | 890  | 1350 | 2030 |      |      |      |      |      |
|       | 10  |  |      |      | 270  | 420  | 660  | 1010 | 1520 | 1870 |      |      |      |      |
|       | 15  |  |      |      |      | 290  | 450  | 690  | 1040 | 1280 | 1540 |      |      |      |
|       | 20  |  |      |      |      |      | 350  | 530  | 810  | 990  | 1200 | 1450 |      |      |
|       | 25  |  |      |      |      |      |      | 280  | 430  | 650  | 800  | 970  | 1170 | 1340 |
|       | 30  |  |      |      |      |      |      |      | 350  | 540  | 660  | 800  | 970  | 1110 |
| 460   | 1.5 | 1700   |      |      |      |      |      |      |      |      |      |      |      |      |
|       | 2   | 1300   | 2070 |      |      |      |      |      |      |      |      |      |      |      |
|       | 3   | 1000   | 1600 | 2520 |      |      |      |      |      |      |      |      |      |      |
|       | 5   | 590  | 950  | 1500 | 2360 |      |      |      |      |      |      |      |      |      |
|       | 7.5 | 420  | 680  | 1070 | 1690 | 2640 |      |      |      |      |      |      |      |      |
|       | 10  | 310  | 500  | 790  | 1250 | 1960 | 3050 |      |      |      |      |      |      |      |
|       | 15  |  |      | 540  | 850  | 1340 | 2090 | 3200 |      |      |      |      |      |      |
|       | 20  |  |      | 410  | 650  | 1030 | 1610 | 2470 | 3730 |      |      |      |      |      |
|       | 25  |  |      |      | 530  | 830  | 1300 | 1990 | 3010 | 3700 |      |      |      |      |
|       | 30  |  |      |      | 430  | 680  | 1070 | 1640 | 2490 | 3060 | 3700 |      |      |      |
|       | 40  |  |      |      |      | 790  | 1210 | 1830 | 2250 | 2710 | 3290 |      |      |      |
|       | 50  |  |      |      |      |      | 640  | 980  | 1480 | 1810 | 2190 | 2650 | 3010 |      |
|       | 60  |  |      |      |      |      |      | 830  | 1250 | 1540 | 1850 | 2240 | 2540 | 2890 |
|       | 75  |  |      |      |      |      |      |      | 1030 | 1260 | 1520 | 1850 | 2100 | 2400 |
|       | 100 |  |      |      |      |      |      |      |      | 940  | 1130 | 1380 | 1560 | 1790 |
|       | 125 |  |      |      |      |      |      |      |      |      | 1080 | 1220 | 1390 |      |
|       | 150 |  |      |      |      |      |      |      |      |      |      | 1050 | 1190 |      |
|       | 200 |  |      |      |      |      |      |      |      |      |      |      | 1080 | 1300 |
| 250   |     |  |      |      |      |      |      |      |      |      |      |      | 1080 |      |

**Three-phase motor maximum cable length [ft]  
(Motor to service entrance) (2)**

**US**

|     |     |      |      |      |      |      |      |                          |
|-----|-----|------|------|------|------|------|------|--------------------------|
|     | 1.5 | 2620 |      |      |      |      |      |                          |
|     | 2   | 2030 |      |      |      |      |      |                          |
|     | 3   | 1580 | 2530 |      |      |      |      |                          |
|     | 5   | 920  | 1480 | 2330 |      |      |      |                          |
|     | 7.5 | 660  | 1060 | 1680 | 2650 |      |      |                          |
|     | 10  | 490  | 780  | 1240 | 1950 |      |      |                          |
|     | 15  |      | 530  | 850  | 1340 | 2090 |      |                          |
| 575 | 20  |      |      | 650  | 1030 | 1610 | 2520 |                          |
|     | 25  |      |      | 520  | 830  | 1300 | 2030 | 3110                     |
|     | 30  |      |      |      | 680  | 1070 | 1670 | 2560 3880                |
|     | 40  |      |      |      |      | 790  | 1240 | 1900 2860 3510           |
|     | 50  |      |      |      |      |      | 1000 | 1540 2310 2840 3420      |
|     | 60  |      |      |      |      |      | 850  | 1300 1960 2400 2890 3500 |
|     | 75  |      |      |      |      |      | 1060 | 1600 1970 2380 2890 3290 |
|     | 100 |      |      |      |      |      | 1190 | 1460 1770 2150 2440 2790 |

**Caution** Use of wire size smaller than listed will void warranty.

**Notes:**

- If aluminum conductor is used, multiply lengths by 0.5. Maximum allowable length of aluminum is considerably shorter than copper wire of same size.
- The portion of the total cable which is between the service entrance and a 3Ø motor starter should not exceed 25 % of the total maximum length to assure reliable starter operation. Single-phase control boxes may be connected at any point of the total cable length.
- Cables #14 to #0000 are AWG sizes, and 250 to 300 are MCM sizes.

## 7.6 Electrical data

### 7.6.1 Grundfos submersible pump motors - 60 Hz

| Grundfos submersible pump motors - 60 Hz                              |    |          |      |                          |       |           |          |          |              |      |                   |                   |                |
|---|----|----------|------|--------------------------|-------|-----------|----------|----------|--------------|------|-------------------|-------------------|----------------|
| Hp  | Ph | Volt [V] | S.F. | Circuit breaker or fuses |       |           | Amperage |          | Full load    |      | Max. thrust [lbs] | Name-plate number | Product number |
|   |    |          |      | Std.                     | Delay | Start [A] | Max. [A] | Eff. [%] | Power factor |      |                   |                   |                |
|   |    |          |      |                          |       |           |          |          |              |      |                   |                   |                |
| <b>4-inch, single-phase, 2-wire motors (control box not required)</b> |    |          |      |                          |       |           |          |          |              |      |                   |                   |                |
| .5  | 1  | 230      | 1.60 | 15                       | 7     | 34.5      | 6.0      | 62       | 76           | 750  | 79952102          | 96465616          |                |
| .75   |    |          | 1.50 | 20                       | 9     | 40.5      | 8.4      | 62       | 75           | 750  | 79952103          | 96465618          |                |
| 1   |    |          | 1.40 | 25                       | 12    | 48.4      | 9.8      | 63       | 82           | 750  | 79952104          | 96465620          |                |
| 1.5   |    |          | 1.30 | 35                       | 15    | 62.0      | 13.1     | 64       | 85           | 750  | 79952105          | 96465622          |                |
| <b>4-inch, single-phase, 3-wire motors</b>                            |    |          |      |                          |       |           |          |          |              |      |                   |                   |                |
| .5  | 1  | 230      | 1.60 | 15                       | 7     | 21.5      | 6.0      | 62       | 76           | 750  | 79453102          | 96465606          |                |
| .75   |    |          | 1.50 | 20                       | 9     | 31.4      | 8.4      | 62       | 75           | 750  | 79453103          | 96465608          |                |
| 1   |    |          | 1.40 | 25                       | 12    | 37.0      | 9.8      | 63       | 82           | 750  | 79453104          | 96465610          |                |
| 1.5   |    |          | 1.30 | 35                       | 15    | 45.9      | 11.6     | 69       | 89           | 750  | 79453105          | 96465612          |                |
| <b>4-inch, three-phase, 3-wire motors</b>                             |    |          |      |                          |       |           |          |          |              |      |                   |                   |                |
| 1.5   | 3  | 230      | 1.30 | 15                       | 8     | 40.3      | 7.3      | 75       | 72           | 750  | 79302005          | 96465629          |                |
|   |    | 460      | 1.30 | 10                       | 4     | 20.1      | 3.7      | 75       | 72           | 750  | 79362005          | 96465651          |                |
|   |    | 575      | 1.30 | 10                       | 4     | 16.1      | 2.9      | 75       | 72           | 750  | 79392005          | 96465630          |                |
| 2   | 3  | 230      | 1.25 | 20                       | 10    | 48        | 8.7      | 76       | 75           | 750  | 79302006          | 96465652          |                |
|   |    | 460      | 1.25 | 10                       | 5     | 24        | 4.4      | 76       | 75           | 750  | 79362006          | 791539066         |                |
|   |    | 575      | 1.25 | 10                       | 4     | 19.2      | 3.5      | 76       | 75           | 750  | 79392006          | 791539066         |                |
| 3   | 3  | 230      | 1.15 | 30                       | 15    | 56        | 12.2     | 77       | 75           | 1000 | 79304507          | 96405801          |                |
|   |    | 460      | 1.15 | 15                       | 7     | 28        | 6.1      | 77       | 75           | 1000 | 79354507          | 96405810          |                |
|   |    | 575      | 1.15 | 15                       | 6     | 22        | 4.8      | 77       | 75           | 1000 | 79394507          | 96405815          |                |
| 5   | 3  | 230      | 1.15 | 40                       | 25    | 108       | 19.8     | 80       | 82           | 1000 | 79304509          | 96405802          |                |
|   |    | 460      | 1.15 | 20                       | 12    | 54        | 9.9      | 80       | 82           | 1000 | 79354509          | 96405811          |                |
|   |    | 575      | 1.15 | 15                       | 9     | 54        | 7.9      | 80       | 82           | 1000 | 79394509          | 96405816          |                |
| 7.5   | 3  | 230      | 1.15 | 60                       | 30    | 130       | 25.0     | 81       | 82           | 1000 | 79305511          | 96405805          |                |
|   |    | 460      | 1.15 | 35                       | 15    | 67        | 13.2     | 81       | 82           | 1000 | 79355511          | 96405814          |                |
|   |    | 575      | 1.15 | 30                       | 15    | 67        | 10.6     | 81       | 82           | 1000 | 79395511          | 96405819          |                |
| <b>6-inch, three-phase, 3-wire motors</b>                             |    |          |      |                          |       |           |          |          |              |      |                   |                   |                |
| 7.5   | 3  | 230      | 1.15 | 60                       | 35    | 119       | 26.4     | 80.5     | 76           | 1000 | 78305511          | 96405781          |                |
|   |    | 460      | 1.15 | 30                       | 15    | 59        | 13.2     | 80.5     | 76           | 1000 | 78355511          | 96405794          |                |
| 10  | 3  | 230      | 1.15 | 80                       | 45    | 156       | 34.0     | 82.5     | 79           | 1000 | 78305512          | 96405782          |                |
|   |    | 460      | 1.15 | 40                       | 20    | 78        | 17.0     | 82.0     | 79           | 1000 | 78355512          | 96405795          |                |
| 15  | 3  | 230      | 1.15 | 150                      | 80    | 343       | 66.0     | 84.0     | 81           | 4400 | 78305516          | 96405784          |                |
|   |    | 460      | 1.15 | 60                       | 30    | 115       | 24.5     | 82.5     | 82           | 4400 | 78305514          | 96405796          |                |
| 20  | 3  | 230      | 1.15 | 150                      | 80    | 343       | 66.0     | 84       | 81           | 4400 | 78305516          | 96405784          |                |
|   |    | 460      | 1.15 | 80                       | 40    | 172       | 33.0     | 84       | 82           | 4400 | 78355516          | 96405797          |                |
| 25  | 3  | 460      | 1.15 | 100                      | 50    | 217       | 41.0     | 84.5     | 80           | 4400 | 78355517          | 96405798          |                |
| 30  | 3  | 460      | 1.15 | 110                      | 60    | 237       | 46.5     | 85       | 83           | 4400 | 78355518          | 96405799          |                |
| 40  | 3  | 460      | 1.15 | 150                      | 80    | 320       | 64.0     | 85       | 82           | 4400 | 78355520          | 96405800          |                |

### 7.6.2 Other motor manufacturers

#### Hitachi motors

Refer to the Hitachi submersible motors application maintenance manual.

**7.6.3 Franklin motors**

Refer to the Franklin submersible motors application maintenance manual.

**7.6.4 Correcting for three-phase power imbalance**

**Example:** Check for current unbalance for a 230 volt, three-phase, 60 Hz submersible pump motor, 18.6 full load amps.

**Solution:** Steps 1 to 3 measure and record amps on each motor drop lead for Hookups 1, 2 and 3. Observe that Hookup 3 should be used since it shows the least amount of current unbalance. Therefore, the motor will operate at maximum

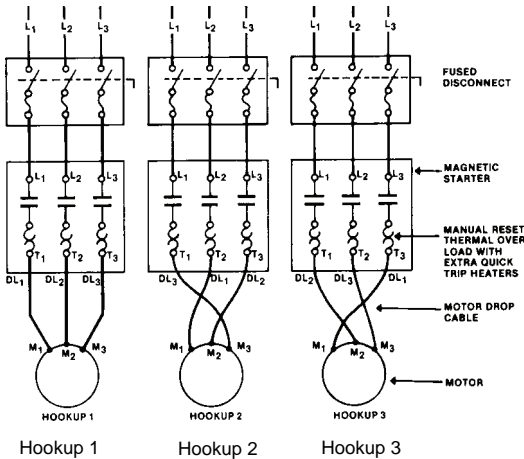
efficiency and reliability.

By comparing the current values recorded on each leg, you will note the highest value was always on the same leg, L<sub>3</sub>. This indicates the unbalance is in the power source. If the high current values were on a different leg each time the leads were changed, the unbalance would be caused by the motor or a poor connection.

If the current is greater than 5 %, contact your power company for help.

\*For a detailed explanation of three-phase balance procedures, see section 4.1 Startup with three-phase motors on p. 11.

|                   | Step 1 (Hookup 1)                         | Step 2 (Hookup 2)  | Step 3 (Hookup 3)           |
|-------------------|---|--|-----------------------------|
| (T <sub>1</sub> ) | DL <sub>1</sub> = 25.5 amps               | DL <sub>3</sub> = 25 amps  | DL <sub>2</sub> = 25.0 amps |
| (T <sub>2</sub> ) | DL <sub>2</sub> = 23.0 amps               | DL <sub>1</sub> = 24 amps  | DL <sub>3</sub> = 24.5 amps |
| (T <sub>3</sub> ) | DL <sub>3</sub> = 26.5 amps               | DL <sub>2</sub> = 26 amps  | DL <sub>1</sub> = 25.5 amps |
| <b>Step 4</b>     | Total = 75 amps                           | Total = 75 amps  | Total = 75 amps             |
| <b>Step 5</b>     | Average Current =                         | $\frac{\text{total current}}{3 \text{ readings}} = \frac{75}{3} = 25 \text{ amps}$         |                             |
| <b>Step 6</b>     | Greatest amp difference from the average: | (Hookup 1) = 25-23 = 2<br>(Hookup 2) = 26-25 = 1<br>(Hookup 3) = 25.5-25 = .5              |                             |
| <b>Step 7</b>     | % Unbalance                               | (HOOKUP 1) = 2/25 X 100 = 8<br>(HOOKUP 2) = 1/25 X 100 = 4<br>(HOOKUP 3) = .5/25 X 100 = 2 |                             |



TM05 0042 0611

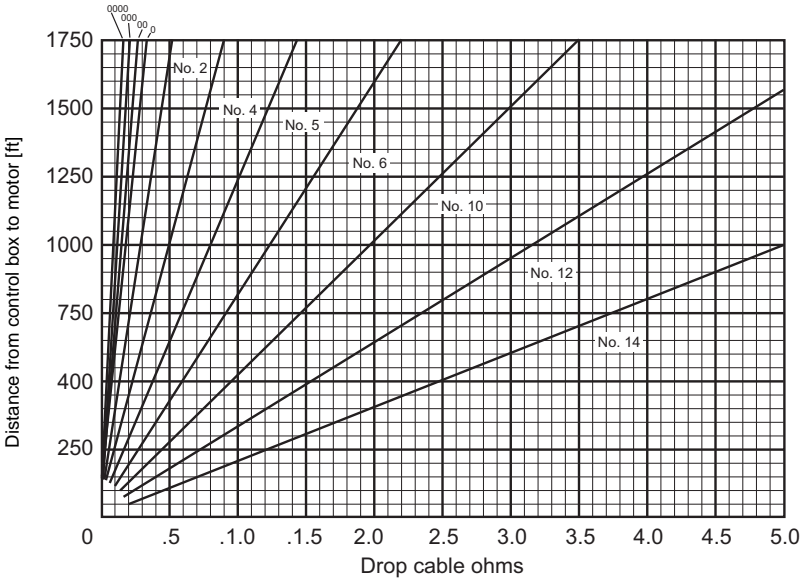
Fig. 14

**7.6.5 Total resistance of drop cable (OHMS)**

The values shown in this table are for copper conductors. Values are for the total resistance of drop cable from the control box to the motor and back.

To determine the resistance:

1. Disconnect the drop cable leads from the control box or panel.
2. Record the size and length of drop cable.
3. Determine the cable resistance from the table.
4. Add drop cable resistance to motor resistance. Motor resistances can be found in section 7.6 *Electrical data* on p. 24.
5. Measure the resistance between each drop cable lead using an ohmmeter. Meter should be set on Rx1 and zero-balanced for this measurement.
6. The measured values should be approximately equal to the calculated values.



TM05 0043 0611

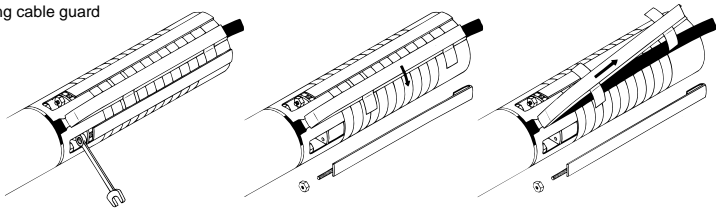
**8. Disposal**

This product or parts of it must be disposed of in an environmentally sound way:

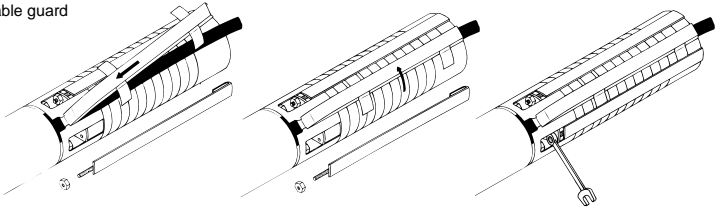
1. Use the public or private waste collection service.
2. If this is not possible, contact the nearest Grundfos company or service workshop.

## 9. Removal and fitting of cable guard

Removing cable guard

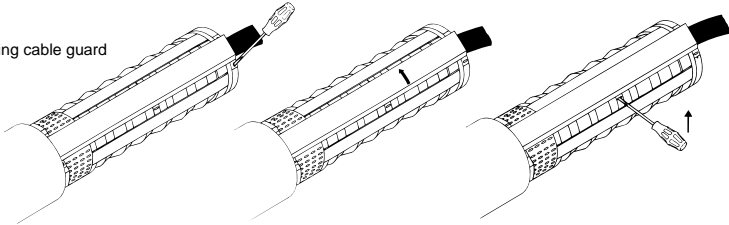


Fitting cable guard

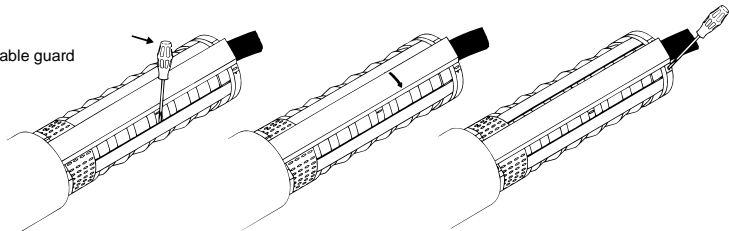


**Fig. 15** Removal and fitting of cable guard for SP 85S, 150S, 230S, and 300S

Removing cable guard



Fitting cable guard



**Fig. 16** Removal and fitting of cable guard for SP 385S, 475S, 625S, 800S, and 1100S

US

TM00 1325

TM00 1326

This page intentionally left blank.

**U.S.A.**

GRUNDFOS Pumps Corporation  
17100 West 118th Terrace  
Olathe, Kansas 66061  
Phone: +1-913-227-3400  
Telefax: +1-913-227-3500

**Canada**

GRUNDFOS Canada Inc.  
2941 Brighton Road  
Oakville, Ontario  
L6H 6C9  
Phone: +1-905 829 9533  
Telefax: +1-905 829 9512

**México**

Bombas GRUNDFOS de México  
S.A. de C.V.  
Boulevard TLC No. 15  
Parque Industrial Stiva  
Aeropuerto  
Apodaca, N.L.C.P. 66600  
Phone: +52-81-8144 4000  
Telefax: +52-81-8144 4010

This page intentionally left blank.

This page intentionally left blank.

|                          |           |
|--------------------------|-----------|
| <b>L-SP-TL-031</b> 05.11 | <b>US</b> |
| Repl. 02.00              |           |

© 2000, 2011 Grundfos Pumps Corp.

The name Grundfos, the Grundfos logo, and the payoff Be-Think-Innovate are registered trademarks owned by Grundfos Management A/S or Grundfos A/S, Denmark. All rights reserved worldwide.

Subject to alterations.