

Features

- Includes Purist® 1.75-gpm multifunction handshower, 60" metal hose, 28" sidebar and contemporary sidebar trim
- Multifunction showerhead and handshower each have advanced spray engines to provide three experiences: full coverage, pulsating massage, and silk spray
- Full coverage spray produces an encompassing spray ideal for everyday use
- Pulsating massage spray targets sore muscles to ease away aches and pains
- Silk spray releases a dense, luxurious spray ideal for rinsing
- Thumb tab allows for a smooth transition between sprays
- Combination of balance, weight, grip, and angle makes this handshower comfortable and easy to use
- MasterClean™ sprayface features an easy-to-clean surface that withstands mineral buildup and maximizes spray performance
- 1.75 gpm (6.6 lpm) flow rate.
- Sidebar features adjustable mounting brackets for installation flexibility
- Coordinates with Purist®, Stillness®, and Composed® faucets and accessories
- Features a nonpositive shutoff: water-saving pause mode to temporarily reduce water flow
- Pause feature temporarily pauses water flow to conserve water while you lather, shave, or shampoo

Material

- KOHLER finishes resist corrosion and tarnishing



Codes/Standards









ASME A112.18.1/CSA B125.1
DOE - Energy Policy Act 1992
EPA WaterSense®
California Energy Commission (CEC)
ADA
ICC/ANSI A117.1
NOM Standards
NOM 008-CONAGUA

KOHLER® Faucet Lifetime Limited Warranty

See website for detailed warranty information.

Available Colors/Finishes

Color tiles intended for reference only.

Color	Code	Description
	CP	Polished Chrome
	AF	Vibrant® French Gold
	BN	Vibrant® Brushed Nickel
	BV	Vibrant® Brushed Bronze
	BL	Matte Black
	2MB	Vibrant® Brushed Moderne Brass
	BGP	Vibrant Brushed Graphite
	TT	Vibrant Titanium

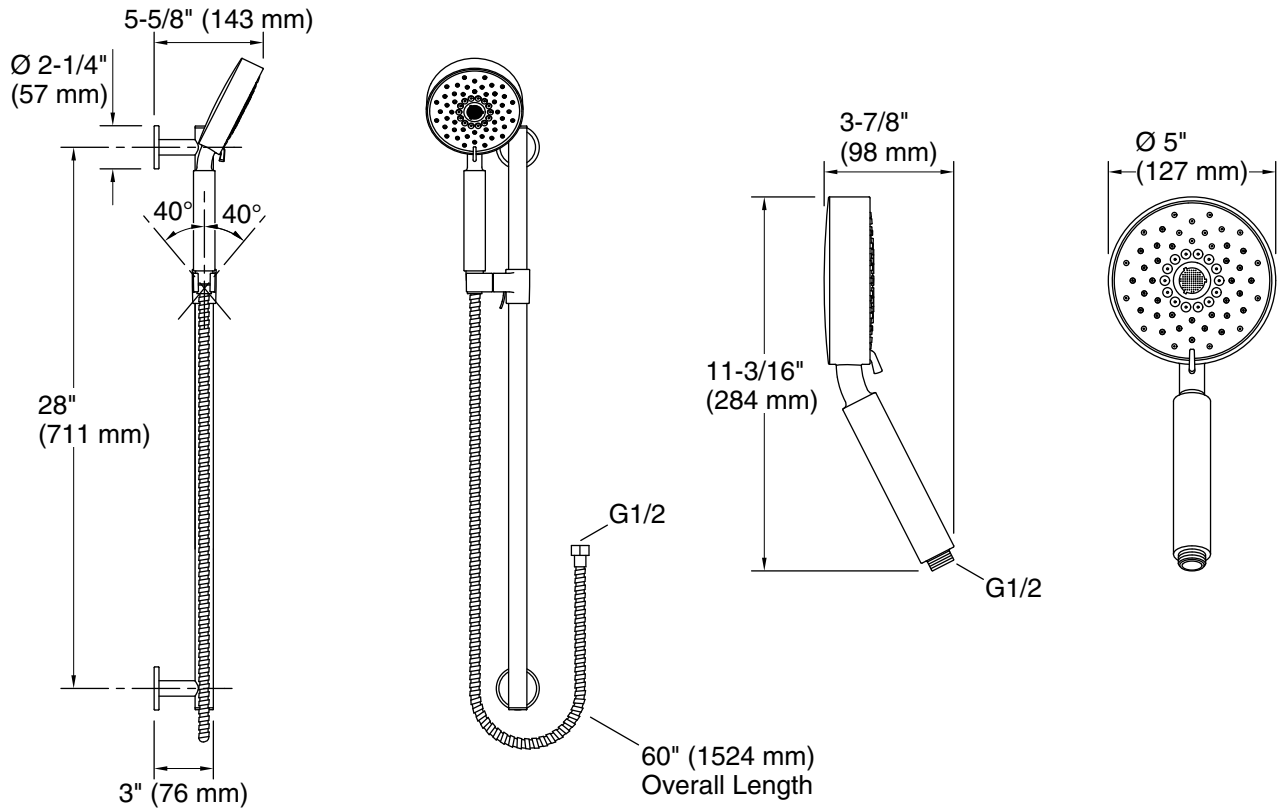

Technical Information

All product dimensions are nominal.

Spout:

Handshower rated max flow: 1.75 gal/min (6.6 l/min)

Shower/Rainhead rated max flow: 1.75 gal/min (6.6 l/min)

Notes

Install this product according to the installation instructions.

IMPORTANT! The slide bar must be mounted to stud framing supports at both the top and bottom mounting locations. Plastic wall anchors will not support the slide bar. Do not use or depend on plastic wall anchors to attach the slide bar.

Plumbing codes may require that an atmospheric vacuum breaker be installed in-line to handshowers. Consult with local codes.

ADA compliant when installed to the specific requirements of these regulations.