

# PIONEER INDUSTRIES

**2018**  
PRICE CATALOG  
Effective October 1st, 2017

DEDICATED TO BUILDERS & CONTRACTORS



MULTI-FAMILY • SINGLE-FAMILY • COMMERCIAL  
QUALITY FAUCETS & FIXTURES

OLYMPIA

PIONEER

Central Brass



# TO OUR VALUED CUSTOMER

The Pioneer family of brands has provided top-quality faucets and fixtures to builders, contractors and designers for over three decades. Each of our brands – Pioneer, Olympia and Central Brass – are uniquely designed to meet the needs of their respective markets, while consistently delivering on the Pioneer promise of excellence and reliability. All of our products are nationally distributed, with warehouses in Los Angeles, CA, and Columbus, OH.

Every Pioneer product is assembled, tested and inspected at our state-of-the-art manufacturing facility. Rigorous quality control measures ensure that each faucet meets our uncompromising standards, as well as all pertinent codes and regulations. Unparalleled reliability and outstanding value, combined with excellent customer service, are why Pioneer products have become the primary choice of some of the nation’s most respected builders and contractors.

From your initial quote to after-sale service and support, we will give you our best and we won’t stop until you’re satisfied.

We thank you for your continued loyalty.

## HOW TO ORDER

Simply fax your order, or call our customer service line:

**Email:** sales@pioneerind.com

**Fax Order Number:** 323.888.9515

**Customer Service Hotline:** 800.338.9468

## PIONEER

Customer Service Hotline: 800.338.9468

Email: sales@pioneerind.com

## OLYMPIA

Customer Service Hotline: 888.772.7701

Email: sales@olympiafaucets.com

## CENTRAL BRASS

Customer Service Hotline: 800.321.8630

Email: sales@centralbrass.com



IAPMO Listed  
File# 3778



IAPMO Listed  
File# N-5814



IAPMO Listed  
File# 6060



IAPMO Listed  
File# 6260



Product is compliant with Federal safe drinking water legislation and state level legislation, including AB1953, S152 and HB372.



Product meets Cal Green flow standards: lavatory faucets with a 1.5 GPM rating, and kitchen faucets with a 1.8 GPM or less



Products displaying the ADA logo comply with applicable requirements specified in the Americans Disability Act.



Indicates products that are WaterSense Certified



All Pioneer products are compliant with the Buy America Act.



Indicates products that meet low-flow requirements.



# PIONEER INDUSTRIES

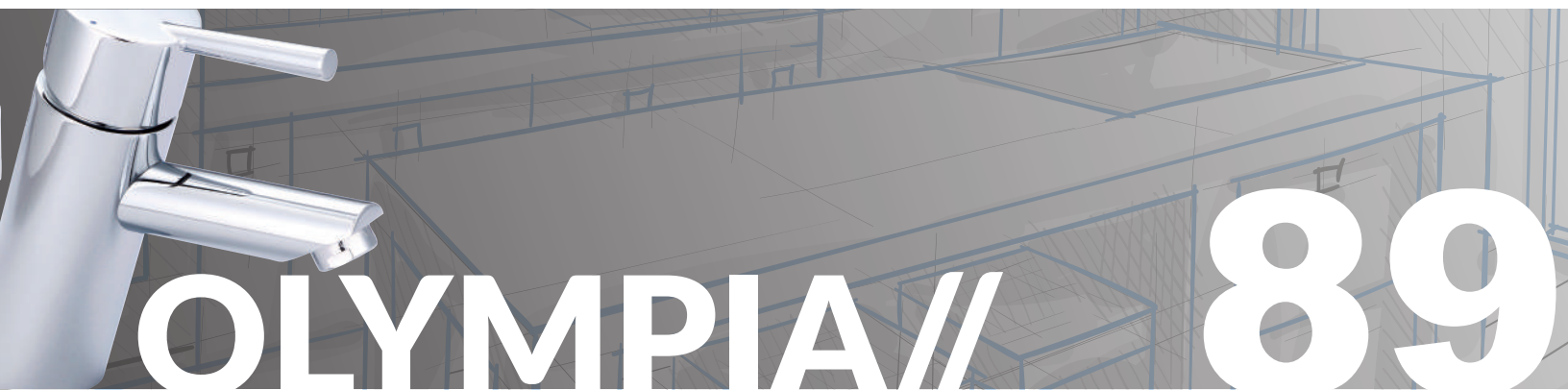

# PIONEER TABLE OF CONTENTS

<b>MOD</b>	
Lavatory Faucets	17
Tub & Shower Trim Sets	20
Bathroom Hardware	25
<b>MOTEGI</b>	
Kitchen Faucets	26
Lavatory Faucets	30
Tub & Shower Sets	33
Bathroom Hardware	38
<b>LEGACY</b>	
Kitchen Faucets	39
Bar Faucets	43
Lavatory Faucets	44
Tub & Shower Trim Sets	50
<b>PREMIUM</b>	
Kitchen Faucets	52
Bar Faucets	53
<b>DEL MAR</b>	
Kitchen Faucets	54
Bar Faucets	56
Lavatory Faucets	57
Tub & Shower Sets	59
<b>AMERICANA</b>	
Kitchen Faucets	63
Lavatory Faucets	65
Tub & Shower Sets	66
<b>BRENTWOOD</b>	
Lavatory Faucets	67
<b>ACCESSORIES</b>	69
<b>VALVES</b>	72
<b>CERAMIC DISC CARTRIDGES</b>	75
<b>MISC. PARTS</b>	77
<b>EXTENSIONS &amp; ADAPTERS</b>	79
<b>TERMS &amp; CONDITIONS</b>	<b>231</b>

# OLYMPIA TABLE OF CONTENTS

<b>KITCHEN</b>	
Single Handle Faucets	89
Two Handle Faucets	94
<b>BAR/LAUNDRY</b>	
Two Handle Faucets	99
<b>BAR</b>	
Two Handle Faucets	101
<b>LAVATORY</b>	
Single Handle Faucets	102
Two Handle Faucets	108
<b>TUB &amp; SHOWER</b>	
Pressure Balance Trim Set	116
Single Handle Shower Set	127
Multi Handle Shower Set	128
Handheld Shower Sets	132
Roman Tub Sets	134
Valves	135
<b>ACCESSORIES</b>	
Lavatory Drains	138
Tub Spouts	139
Showerheads	140
Strainers	141
Miscellaneous	142
Aerators	143
<b>TERMS &amp; CONDITIONS</b>	<b>232</b>

# CENTRAL BRASS TABLE OF CONTENTS

<b>KITCHEN</b>	
Pre-Rinse Faucets	153
Pre-Rinse Accessories	165
Single Handle Faucets	167
Two Handle Faucets	168
Wallmount Faucets	173
<b>SERVICE SINK</b>	
Faucets	175
<b>BAR</b>	
Glass Filler	177
Single Handle Faucets	178
Two Handle Faucets	179
<b>BAR / LAUNDRY</b>	
Faucets	181
Laundry Faucets	183
<b>WORKBOARD SINKS</b>	
Workboard Sink Faucets	184
<b>LAVATORY</b>	
Two Handle Faucets	185
Single Basin Faucets	189
<b>TUB &amp; SHOWER</b>	
Sets	190
Trim Kits	196
Specialty Products	198
Bath Drains	202
Bath Drain Trim Kit	204
<b>DRINKING FAUCETS</b>	
Bubbler Heads	205
<b>SPECIALTY</b>	
Wallmount Single Handle Faucets	208
Self-Closing Faucets	210
Valves	211
Lawn Faucets	212
Shampoo Faucets	213
Accessories	214
<b>CHARTS</b>	
Spouts	217
Handles	221
Miscellaneous	223
<b>PARTS</b>	<b>225</b>
<b>TERMS &amp; CONDITIONS</b>	<b>233</b>







# PIONEER //

## **2018 PIONEER PRODUCT CATALOG PRICE INDEX**

## 2018 PIONEER PRODUCT CATALOG PRICE INDEX

MODEL	PAGE	PCS/ CS	LIST PRICE	MODEL	PAGE	PCS/ CS	LIST PRICE	MODEL	PAGE	PCS/ CS	LIST PRICE
2AM400	63	6	\$376.00	2MT171H	26	6	\$396.00	3LG160H	44	12	\$138.00
2AM400-BN	63	6	\$408.40	2MT171H-BN	26	6	\$427.00	3LG160H-BN	44	12	\$150.00
2AM400-ORB	63	6	\$427.00	2MT182H	26	6	\$292.00	3LG161	44	12	\$109.00
2AM401	63	6	\$490.00	2MT182H-BN	26	6	\$325.00	3LG161G	44	12	\$130.00
2AM401-BN	63	6	\$534.40	2MT250	27	6	\$425.00	3LG260BH	46	12	\$157.00
2AM401-ORB	63	6	\$563.00	2MT250-BN	27	6	\$469.00	3LG260BH-BN	46	12	\$168.00
2AM500	63	6	\$386.00	2MT250-SS	27	6	\$469.00	3LG260H	46	12	\$159.00
2AM500-BN	63	6	\$407.00	2MT251	27	6	\$394.00	3LG260H-BN	46	12	\$170.00
2AM500-ORB	63	6	\$444.00	2MT251-BN	27	6	\$434.00	3LG260H-WD	46	12	\$166.00
2AM501	63	6	\$500.00	2MT260	27	6	\$447.00	3LG260H-WD-BN	46	12	\$182.60
2AM501-BN	63	6	\$532.00	2MT260-BN	27	6	\$492.00	3LG260H-WD-MZ	46	12	\$199.00
2AM501-MZ	63	6	\$573.00	2MT261	27	6	\$416.00	3LG262BH	46	12	\$143.00
2AM501-ORB	63	6	\$573.00	2MT270	27	4	\$465.00	3LG264GH	46	12	\$153.00
2AM501-SS	63	6	\$532.00	2MT270-BN	27	4	\$555.00	3LG264GH-WD	46	12	\$163.00
2AM600	63	6	\$364.70	2MT275	27	4	\$449.00	3LG264H	46	12	\$130.00
2AM600-BN	63	6	\$381.10	2MT275-BN	27	4	\$536.00	3LG264H-BN	46	12	\$143.00
2AM600-MZ	63	6	\$396.00	2MT600	28	6	\$376.00	3LG264H-WD	46	12	\$140.00
2AM600-ORB	63	6	\$396.00	2MT600-BN	28	6	\$402.00	3LG264H-WD-BN	46	12	\$154.00
2AM600-SS	63	6	\$381.10	2MT600-SS	28	6	\$402.00	3MO160	17	6	\$242.00
2AM700	63	6	\$459.00	2PM440	52	12	\$170.00	3MO160-BN	17	6	\$361.20
2AM700-BN	63	6	\$490.00	2PM540	52	12	\$170.00	3MO160-MB	17	6	\$290.00
2AM700-ORB	63	6	\$527.00	3AM400	65	6	\$381.00	3MO160-WD	17	6	\$247.00
2AM700-SS	63	6	\$490.00	3AM400-BN	65	6	\$407.00	3MO160-WD-BN	17	6	\$366.20
2DM201	54	6	\$314.00	3AM400-MZ	65	6	\$438.00	3MO168	17	6	\$290.50
2DM201-BN	54	6	\$340.00	3AM400-ORB	65	6	\$438.00	3MO168-BN	17	6	\$403.80
2DM201-ORB	54	6	\$354.00	3BR300	67	6	\$142.00	3MO180	17	6	\$242.00
2DM300	54	6	\$170.00	3BR300-BN	67	6	\$157.00	3MO180-BN	17	6	\$361.20
2DM301	54	6	\$203.00	3BR300-ORB	67	6	\$166.00	3MO180-WD	17	6	\$247.00
2DM301-BN	54	6	\$219.00	3BR310	67	6	\$142.00	3MO180-WD-BN	17	6	\$366.20
2DM301-MZ	54	6	\$232.00	3BR310-BN	67	6	\$157.00	3MO200	19	6	\$367.40
2LG110	42	12	\$134.00	3BR400	67	6	\$276.00	3MO200-BN	19	6	\$538.30
2LG160	39	12	\$142.00	3BR400-BN	67	6	\$292.00	3MO200-MB	19	6	\$441.00
2LG160B	39	12	\$140.00	3BR400-ORB	67	6	\$318.00	3MT160	30	6	\$218.00
2LG160H	39	12	\$144.00	3BR410	67	6	\$276.00	3MT160B	30	6	\$216.00
2LG160H-BN	39	12	\$156.00	3BR410-BN	67	6	\$292.00	3MT160-BN	30	6	\$226.00
2LG161	39	12	\$174.00	3DM100	57	6	\$177.00	3MT161	30	6	\$185.00
2LG161B	39	12	\$172.00	3DM100-BN	57	6	\$191.70	3MT161-BN	30	6	\$197.00
2LG161B-BN	39	12	\$187.00	3DM200	58	6	\$301.00	3MT161G	30	6	\$210.00
2LG161-BN	39	12	\$189.00	3DM200-BN	58	6	\$322.00	3MT161G-BN	30	6	\$222.00
2LG161H	39	12	\$176.00	3DM300	58	6	\$294.00	3MT168	30	6	\$248.00
2LG161H-BN	39	12	\$191.00	3DM300-ORB	58	6	\$339.00	3MT168-BN	30	6	\$260.00
2LG162	39	12	\$174.00	3LG110	48	12	\$116.00	3MT168-ORB	30	6	\$289.00
2LG240	42	6	\$140.00	3LG111	48	12	\$88.00	3MT170	31	6	\$218.00
2LG250	41	6	\$329.00	3LG121	48	12	\$96.00	3MT170B	31	6	\$216.00
2LG250-BN	41	6	\$354.00	3LG121G	48	12	\$119.00	3MT170-BN	31	6	\$226.00
2LG250-ORB	41	6	\$363.00	3LG130	48	12	\$123.00	3MT170-MB	31	6	\$248.00
2LG260	40	12	\$144.00	3LG130-BN	48	12	\$127.00	3MT178	31	6	\$248.00
2LG260-BN	40	12	\$155.00	3LG160	44	12	\$136.00	3MT180	31	6	\$318.00
2LG261	40	12	\$176.00	3LG160B	44	12	\$134.00	3MT180-BN	31	6	\$334.00
2MT161H	26	6	\$370.00	3LG160B-BN	44	12	\$146.00	3MT180-MB	31	6	\$348.00
2MT161H-BN	26	6	\$396.00	3LG160-BN	44	12	\$148.00	3MT400	31	6	\$381.00

## 2018 PIONEER PRODUCT CATALOG PRICE INDEX

MODEL	PAGE	PCS/ CS	LIST PRICE	MODEL	PAGE	PCS/ CS	LIST PRICE	MODEL	PAGE	PCS/ CS	LIST PRICE
3MT400-BN	31	6	\$402.00	4MO300T	20	6	\$170.00	7MO030-BN	25	20	\$93.00
3MT420	30	6	\$320.00	4MO300T-BN	20	6	\$219.50	7MO030-MB	25	20	\$86.00
3MT420-BN	30	6	\$352.00	4MO400T	20	6	\$96.10	7MO031	25	20	\$69.30
3MT500	30	6	\$381.00	4MO400T-BN	20	6	\$119.70	7MO031-BN	25	20	\$90.30
3MT500-BN	30	6	\$402.00	4MO610T	23	6	\$369.90	7MO031-MB	25	20	\$83.00
3MT800	32	6	\$263.70	4MO610T-BN	23	6	\$465.40	7MO032	25	40	\$47.80
3MT800-BN	32	6	\$271.00	4MO611	23	4	\$730.80	7MO032-BN	25	40	\$60.40
3MT800-MB	32	6	\$282.00	4MO611-BN	23	4	\$921.70	7MO032-MB	25	40	\$57.50
3MT800T	32	6	\$129.80	4MT110T	33	6	\$376.00	7MO033	25	40	\$32.60
3MT800T-BN	32	6	\$137.10	4MT110T-BN	33	6	\$396.00	7MO033-BN	25	40	\$38.90
4020B	72	12	\$68.00	4MT110T-MB	33	6	\$406.00	7MO033-MB	25	40	\$39.00
4020B-B	72	12	\$66.00	4MT111T	35	6	\$264.00	7MO034	25	40	\$43.60
4020B-D	72	6	\$151.00	4MT111T-LS	35	6	\$214.00	7MO034-BN	25	40	\$56.70
4021B	72	12	\$88.00	4MT115T	35	6	\$479.00	7MO034-MB	25	40	\$52.50
4021B-B	72	12	\$86.00	4MT115T-BN	35	6	\$619.00	7MT030	38	20	\$120.00
4022B	72	12	\$88.00	4MT120T	34	6	\$349.00	7MT030-BN	38	20	\$127.00
4022B-B	72	12	\$86.00	4MT120T-BN	34	6	\$370.00	7MT031	38	20	\$110.00
4023B	72	12	\$88.00	4MT200T	33	6	\$287.00	7MT032	38	40	\$63.00
4023B-B	72	12	\$86.00	4MT200T-BN	33	6	\$308.00	7MT032-BN	38	40	\$67.00
4024B	73	6	\$96.00	4MT300T	33	6	\$229.50	7MT033	38	40	\$63.00
4024B-B	73	6	\$93.00	4MT300T-BN	33	6	\$297.00	X-1200001	39	---	\$22.35
4025B	73	12	\$82.00	4MT320T	34	6	\$194.00	X-1200002	39	---	\$22.35
4025B-B	73	12	\$80.00	4MT320T-BN	34	6	\$271.00	X-1200004	53	---	\$16.75
4027B	73	12	\$85.00	4MT400T	34	6	\$183.00	X-1200005C	52	---	\$15.00
4027B-B	73	12	\$83.00	4MT400T-BN	34	6	\$203.00	X-1200005H	52	---	\$15.00
4100B	73	12	\$83.00	4MT610	37	4	\$444.00	X-1200006	55	---	\$22.35
4200B	74	6	\$133.90	4MT610-BN	37	4	\$464.00	X-1200007C	64	---	\$48.00
4210B	74	6	\$148.50	4MT840	37	6	\$313.00	X-1200007H	64	---	\$48.00
4300B	74	12	\$146.00	4MT840-BN	37	6	\$329.00	X-1200008C	64	---	\$51.00
4AM100T	66	6	\$386.00	4MT840T	37	6	\$179.10	X-1200008H	64	---	\$51.00
4AM100T-BN	66	6	\$404.70	4MT840T-BN	37	6	\$195.10	X-1200009	64	---	\$55.00
4AM100T-ORB	66	6	\$445.80	5DM100	56	12	\$119.00	X-1200010	64	---	\$27.45
4DM100T	59	12	\$200.00	5DM100-BN	56	12	\$131.00	X-1200011	29	---	\$22.35
4DM100T-BN	59	12	\$222.00	5DM100-ORB	56	12	\$136.00	X-1200012	29	---	\$24.40
4DM300T	59	12	\$180.00	5LG120	43	12	\$104.00	X-1200016	41	---	\$19.05
4DM300T-BN	59	12	\$200.00	5LG220	43	12	\$106.00	X-1200018	29	---	\$31.50
4DM300T-ORB	59	12	\$213.00	5PM330	53	6	\$193.00	X-1200019	29	---	\$26.40
4DM610T	62	6	\$227.00	6DM400	61	6	\$245.00	X-1300001	45	---	\$22.35
4DM610T-BN	62	6	\$245.00	6DM400-BN	61	6	\$265.00	X-1300002	45	---	\$22.35
4LG100T	50	12	\$173.00	6DM400-ORB	61	6	\$276.00	X-1300003	45	---	\$7.65
4LG100T-ADA	50	4	\$416.50	6MO101T	20	12	\$82.00	X-1300004C	65	---	\$45.00
4LG100T-BN	50	12	\$193.00	6MO101T-BN	20	12	\$92.00	X-1300004H	65	---	\$45.00
4LG100T-MZ	50	12	\$205.00	6MO400	22	6	\$349.00	X-1300006	32	---	\$18.55
4LG300T-ADA	50	4	\$381.70	6MO400-BN	22	6	\$439.00	X-1300019	18	---	\$24.40
4LG400T-ADA	50	4	\$343.00	6MT101T	34	12	\$78.00	X-1300020	19	---	\$32.50
4MO100T	20	6	\$206.75	6MT101T-BN	34	12	\$87.00	X-1400002	62	---	\$29.45
4MO100T-BN	20	6	\$289.50	6MT400	36	6	\$412.00	X-1400006	37	---	\$42.00
4MO110T	21	6	\$189.00	6MT400-BN	36	6	\$427.00	X-1400025	51	---	\$19.30
4MO110T-BN	21	6	\$253.00	6MT410	36	6	\$198.00	X-1400026	60	---	\$30.45
4MO200T	20	6	\$169.00	6MT410-BN	36	6	\$209.00	X-1400028	35	---	\$37.00
4MO200T-BN	20	6	\$218.00	7MO030	25	20	\$72.00	X-1400029	66	---	\$87.00

# 2018 PIONEER PRODUCT CATALOG PRICE INDEX

MODEL	PAGE	PCS/ CS	LIST PRICE	MODEL	PAGE	PCS/ CS	LIST PRICE	MODEL	PAGE	PCS/ CS	LIST PRICE
X-1400043	21	---	\$32.50	X-2400019	23	---	\$333.29	X-4200041	41	---	\$8.90
X-1400044	23	---	\$32.50	X-2400020	23	---	\$385.00	X-4200044	53	---	\$9.15
X-1600001	35	---	\$31.50	X-2500001	43	---	\$45.00	X-4200045	53	---	\$6.35
X-1600011	60	---	\$30.45	X-2500002	43	---	\$52.00	X-4200046	78	---	\$2.30
X-1900001C	49	---	\$5.35	X-2500003	53	---	\$99.00	X-4200048	53	---	\$13.45
X-1900001H	49	---	\$5.35	X-3200001	75	---	\$16.00	X-4200049	55	---	\$2.30
X-1900002C	42	---	\$10.95	X-3200002	78	---	\$3.30	X-4200050	53	---	\$1.30
X-1900002H	42	---	\$10.95	X-3200003	77	---	\$14.00	X-4200051	53	---	\$1.30
X-1900003C	42	---	\$18.30	X-3200004C	77	---	\$24.40	X-4200053	52	---	\$5.60
X-1900003H	42	---	\$18.30	X-3200004H	77	---	\$24.40	X-4200054	52	---	\$8.15
X-1900004C	49	---	\$19.55	X-3300002C	68	---	\$13.20	X-4200055C	52	---	\$3.30
X-1900004H	49	---	\$19.55	X-3300002H	68	---	\$13.20	X-4200055H	52	---	\$3.30
X-1900005	56	---	\$22.35	X-3300006	18	---	\$12.75	X-4200056	52	---	\$27.45
X-1900007C	65	---	\$47.00	X-3300007	18	---	\$14.25	X-4200057	52	---	\$9.15
X-1900007H	65	---	\$47.00	X-3400001	77	---	\$9.40	X-4200058	42	---	\$5.85
X-1900008	29	---	\$22.35	X-3400002	75	---	\$12.70	X-4200059	64	---	\$121.00
X-1900009C	68	---	\$29.45	X-3400003	75	---	\$21.10	X-4200070	29	---	\$185.99
X-1900009H	68	---	\$29.45	X-3400004	23	---	\$121.66	X-4200089	41	---	\$37.44
X-1900010C	68	---	\$18.30	X-3400007	75	---	\$49.00	X-4200090	52	---	\$1.30
X-1900010H	68	---	\$18.30	X-3600001	76	---	\$22.35	X-4200109	40	---	\$25.40
X-1900011C	68	---	\$16.25	X-3600003	76	---	\$19.97	X-4200111	41	---	\$24.40
X-1900011H	68	---	\$16.25	X-3900001	76	---	\$13.20	X-4200112	41	---	\$1.55
X-1900012C	68	---	\$21.35	X-3900002C	77	---	\$10.70	X-4200113	41	---	\$0.80
X-1900012H	68	---	\$21.35	X-3900002H	77	---	\$10.70	X-4200114	55	---	\$10.70
X-2200001	39	---	\$65.00	X-3900003	76	---	\$12.95	X-4200152	41	---	\$23.35
X-2200002	42	---	\$65.00	X-3900004C	77	---	\$11.60	X-4200155	79	---	\$7.65
X-2200003	42	---	\$68.00	X-3900004H	77	---	\$11.60	X-4200169	41	---	\$32.50
X-2200004	55	---	\$102.00	X-4200001	21	---	\$7.40	X-4200180	29	---	\$57.17
X-2200005	55	---	\$147.00	X-4200002	39	---	\$4.60	X-4300003	45	---	\$1.80
X-2200008	52	---	\$45.00	X-4200003	39	---	\$0.80	X-4300004	45	---	\$2.30
X-2200009	52	---	\$44.00	X-4200004	39	---	\$1.30	X-4300005	45	---	\$0.80
X-2200012	64	---	\$165.00	X-4200005	39	---	\$30.45	X-4300006	57	---	\$2.30
X-2200013	64	---	\$167.00	X-4200006	39	---	\$2.30	X-4300008	57	---	\$12.95
X-2200014	29	---	\$179.00	X-4200007	78	---	\$2.30	X-4300010	58	---	\$17.55
X-2200015	29	---	\$192.00	X-4200008	39	---	\$67.16	X-4300011	19	---	\$16.00
X-2200017	29	---	\$179.00	X-4200009	39	---	\$42.00	X-4300015	65	---	\$11.45
X-2200018	29	---	\$79.00	X-4200010	39	---	\$29.45	X-4300018	65	---	\$1.30
X-2200019	29	---	\$99.00	X-4200011	42	---	\$3.30	X-4300022	32	---	\$90.00
X-2300001	58	---	\$154.00	X-4200012	42	---	\$1.30	X-4300024	47	---	\$1.30
X-2300002	58	---	\$142.00	X-4200013	42	---	\$1.57	X-4300038	47	---	\$16.75
X-2300003	65	---	\$172.00	X-4200014	42	---	\$24.40	X-4300041	58	---	\$14.50
X-2300004	32	---	\$158.00	X-4200015	42	---	\$3.84	X-4300043	32	---	\$45.00
X-2300005	32	---	\$81.00	X-4200016	78	---	\$8.09	X-4300047	49	---	\$13.45
X-2300006	32	---	\$88.00	X-4200017	42	---	\$22.36	X-4300058	49	---	\$8.90
X-2300008	68	---	\$137.00	X-4200018	55	---	\$31.50	X-4300059	49	---	\$9.40
X-2300009	68	---	\$132.00	X-4200020	55	---	\$39.00	X-4300060	57	---	\$9.40
X-2300021	19	---	\$172.00	X-4200021	55	---	\$28.45	X-4300061	57	---	\$14.00
X-2400001	37	---	\$103.00	X-4200022	55	---	\$2.30	X-4300062	57	---	\$18.55
X-2400003	62	---	\$202.00	X-4200023	55	---	\$17.55	X-4300063	58	---	\$12.45
X-2400007	37	---	\$215.00	X-4200025	55	---	\$35.00	X-4300064	58	---	\$14.50
X-2400008	37	---	\$236.00	X-4200032	53	---	\$4.35	X-4300065	58	---	\$20.60

# 2018 PIONEER PRODUCT CATALOG PRICE INDEX

MODEL	PAGE	PCS/ CS	LIST PRICE	MODEL	PAGE	PCS/ CS	LIST PRICE	MODEL	PAGE	PCS/ CS	LIST PRICE
X-4300087	18	---	\$16.50	X-4600036	51	---	\$1.30	X-4900085	43	---	\$10.15
X-4300088	18	---	\$5.25	X-4600045	79	---	\$20.05	X-4900086	43	---	\$14.00
X-4300089	18	---	\$3.00	X-4600048	61	---	\$106.03	X-4900089	29	---	\$6.60
X-4300090	18	---	\$9.00	X-4900001	39	---	\$1.05	X-4900090	36	---	\$91.49
X-4300091	18	---	\$11.25	X-4900002	19	---	\$1.30	X-4900091	64	---	\$12.95
X-4300093	19	---	\$0.75	X-4900004	24	---	\$3.30	X-4900092	64	---	\$9.90
X-4300094	19	---	\$11.25	X-4900005C	49	---	\$1.30	X-4900093	64	---	\$17.55
X-4400002	60	50	\$10.95	X-4900005H	49	---	\$1.30	X-4900095	68	---	\$12.20
X-4400005	78	---	\$44.00	X-4900006	49	---	\$1.30	X-4900096	68	---	\$9.15
X-4400014	62	---	\$35.00	X-4900007	42	---	\$1.80	X-4900097	68	---	\$16.25
X-4400015	62	---	\$41.00	X-4900008	42	---	\$1.30	X-4900105	79	---	\$7.84
X-4400016	62	---	\$7.40	X-4900009C	42	---	\$1.30	X-4900112	37	---	\$93.88
X-4400017	62	---	\$1.30	X-4900009H	42	---	\$1.30	X-4900116	43	---	\$0.70
X-4400018	62	---	\$0.80	X-4900010	42	---	\$1.30	X-4900117	75	---	\$399.00
X-4400024	41	---	\$1.30	X-4900011C	42	---	\$0.80	X-5200003	53	---	\$3.30
X-4400028	23	---	\$1.30	X-4900011H	42	---	\$0.80	X-5200006	39	---	\$2.30
X-4400030	21	---	\$23.35	X-4900012	42	---	\$1.30	X-5200008	53	---	\$5.35
X-4400043	35	---	\$80.00	X-4900013	42	---	\$1.30	X-5200009	53	---	\$2.80
X-4400058	23	---	\$0.80	X-4900014C	49	---	\$2.30	X-5200015	40	---	\$7.40
X-4400062	51	---	\$4.85	X-4900014H	49	---	\$2.30	X-5200019	41	---	\$4.98
X-4400063	23	---	\$13.45	X-4900015	49	---	\$1.30	X-5200021	41	---	\$7.40
X-4400065	66	---	\$27.45	X-4900017	45	---	\$11.95	X-5300001	45	---	\$2.80
X-4400070	78	---	\$36.00	X-4900018	45	---	\$4.10	X-5300003	19	---	\$2.80
X-4400073	23	---	\$3.05	X-4900019	78	---	\$1.30	X-5300005	65	---	\$2.30
X-4400080	21	---	\$4.35	X-4900020	58	---	\$21.35	X-5300007	47	---	\$6.60
X-4400088	79	---	\$38.00	X-4900022	19	---	\$4.35	X-5300008	18	---	\$16.50
X-4400089	79	---	\$49.00	X-4900023	55	---	\$18.30	X-5300012	18	---	\$8.40
X-4400099	18	---	\$1.30	X-4900024	19	---	\$1.30	X-5400003	24	---	\$16.75
X-4400102	23	---	\$4.85	X-4900026	62	---	\$0.80	X-5400008	79	---	\$3.60
X-4400106	23	---	\$78.75	X-4900029	52	---	\$1.30	X-5400009	79	---	\$5.10
X-4400108	23	---	\$25.50	X-4900030	52	---	\$1.80	X-5400010	79	---	\$5.85
X-4400109	23	---	\$30.00	X-4900032	65	---	\$11.95	X-5600001	61	---	\$1.30
X-4400113	23	---	\$11.25	X-4900034	65	---	\$15.75	X-5600004	24	---	\$3.85
X-4400114	23	---	\$9.75	X-4900035	65	---	\$1.30	X-5900001	19	---	\$7.15
X-4500001	43	---	\$11.95	X-4900036	65	---	\$1.30	X-6300001	45	---	\$40.00
X-4500002	43	---	\$14.50	X-4900037	43	---	\$1.95	X-6300002	32	---	\$51.00
X-4500003	43	---	\$1.80	X-4900038	65	---	\$1.30	X-6300003	57	---	\$36.00
X-4600001	61	---	\$31.50	X-4900041	29	---	\$4.85	X-6300005	65	---	\$49.00
X-4600002	61	---	\$1.30	X-4900042C	65	---	\$2.30	X-6300006	32	---	\$39.00
X-4600003	36	---	\$99.00	X-4900042H	65	---	\$2.30	X-6300008	68	---	\$41.00
X-4600004	61	---	\$45.00	X-4900044	18	---	\$2.05	X-6300010	71	25	\$65.00
X-4600005	61	---	\$14.50	X-4900047	24	---	\$1.30	X-6300011	71	25	\$65.00
X-4600006	24	---	\$120.00	X-4900049	36	---	\$69.87	X-6300012	58	---	\$41.00
X-4600011	35	---	\$40.00	X-4900066	42	---	\$1.30	X-6300020	65	---	\$54.00
X-4600015	36	---	\$59.00	X-4900072	29	---	\$7.65	X-6300029	18	---	\$45.75
X-4600016	36	---	\$90.00	X-4900073	29	---	\$14.75	X-6300030	19	---	\$47.25
X-4600020	60	---	\$3.85	X-4900080	21	---	\$1.30	X-6400002	51	---	\$13.20
X-4600025	51	---	\$2.30	X-4900081	39	---	\$8.90	X-6400003	51	---	\$10.95
X-4600031	36	---	\$56.00	X-4900082	42	---	\$9.40	X-6400004	66	21	\$123.00
X-4600032	36	---	\$20.05	X-4900083	42	---	\$13.20	X-6400005	66	---	\$56.00
X-4600035	51	---	\$26.40	X-4900084	43	---	\$9.40	X-6400006	66	---	\$21.35

## 2018 PIONEER PRODUCT CATALOG PRICE INDEX

MODEL	PAGE	PCS/ CS	LIST PRICE
X-6400007	66	---	\$47.00
X-6400008	66	---	\$40.00
X-6400011	35	---	\$15.00
X-6400012	70	6	\$202.00
X-6400013	70	6	\$64.00
X-6400014	69	40	\$52.00
X-6400015	60	---	\$4.85
X-6400019	60	30	\$30.45
X-6400021	60	---	\$39.00
X-6400022	66	---	\$28.45
X-6400024	35	---	\$96.00
X-6400029	71	100	\$24.40
X-6400029-BN	71	100	\$25.40
X-6400029-ORB	71	100	\$27.45
X-6400030	71	100	\$20.30
X-6400030-BN	71	100	\$21.35
X-6400030-ORB	71	100	\$24.40
X-6400031	71	100	\$16.00
X-6400031-BN	71	100	\$16.75
X-6400031-ORB	71	100	\$19.30
X-6400032	71	200	\$10.70
X-6400032-BN	71	200	\$11.95
X-6400032-ORB	71	200	\$13.45
X-6400033	71	200	\$9.90
X-6400033-BN	71	200	\$10.70
X-6400033-ORB	71	200	\$11.20
X-6400034	71	200	\$8.40
X-6400034-BN	71	200	\$9.15
X-6400034-ORB	71	200	\$9.90
X-6400036	69	25	\$102.00
X-6400038	70	6	\$266.00
X-6400045	69	65	\$44.00
X-6400045-BN	69	65	\$46.00
X-6400051	35	---	\$202.00
X-6400052	69	30	\$32.50
X-6400052-BN	69	30	\$39.00
X-6400055	69	18	\$55.00
X-6400055-BN	69	18	\$58.00
X-6400057	66	---	\$130.71
X-6400058	51	---	\$45.00
X-6400059	60	---	\$40.00
X-6400064	21	---	\$39.00
X-6400077	70	18	\$121.00
X-6400078	70	18	\$121.00
X-6400079	69	---	\$35.00
X-6400079-BN	69	---	\$45.00
X-6400081	69	---	\$25.40
X-6400081-BN	69	---	\$39.00
X-6400083	69	---	\$65.00
X-6400083-BN	69	---	\$56.00
X-6400086	21	---	\$80.25





MODEL	PAGE	PCS/ CS	LIST PRICE
X-6400088	121	---	\$49.50
X-6400095	70	---	\$60.00
X-6400097	70	---	\$124.65
X-6400103	21	---	\$11.45
X-6400104	21	---	\$30.00
X-6600001	60	---	\$26.40

2018 PIONEER PRODUCT CATALOG PRICE INDEX



# MOD // Lavatory Faucets

## SINGLE HANDLE LAVATORY FAUCETS

	Model#	Description	Finish	Case	Price
	3MO160	Single Handle Lavatory Faucet Metal Lever Handle	Polished Chrome	6	\$242.00
	3MO160-BN	Rigid Spout	PVD Brushed Nickel	6	\$361.20
	3MO160-MB*	4-3/8" Reach, 4" from Deck to Aerator Ceramic Disc Cartridge 1-Hole Installation Easy-Install 18" Flex Supply Lines With 3/8" Connections Brass Pop-Up Drain Assembly With 1.2 GPM Laminar Flow Rate	Matte Black	6	\$290.00
	3MO160-WD	Single Handle Lavatory Faucet Metal Lever Handle	Polished Chrome	6	\$247.00
	3MO160-WD-BN	Rigid Spout 4-3/8" Reach, 4" from Deck to Aerator Ceramic Disc Cartridge 1 or 3-Hole 4" Installation Easy-Install 18" Flex Supply Lines With 3/8" Connections Brass Pop-Up Drain Assembly Deck Cover Plate Included With 1.2 GPM Laminar Flow Rate	PVD Brushed Nickel	6	\$366.20
	3MO168	Single Handle Lavatory Faucet Metal Lever Handle	Polished Chrome	6	\$290.50
	3MO168-BN	Rigid Spout 4-3/8" Reach, 12" from Deck to Aerator Ceramic Disc Cartridge 1-Hole Installation Easy-Install 18" Flex Supply Lines With 3/8" Connections With 1.2 GPM Laminar Flow Rate	PVD Brushed Nickel	6	\$403.80
	3MO180	Single Handle Lavatory Faucet Metal Lever Handle	Polished Chrome	6	\$242.00
	3MO180-BN	Rigid Spout 4-7/8" Reach, 6" from Deck to Aerator Ceramic Disc Cartridge 1-Hole Installation Easy-Install 18" Flex Supply Lines With 3/8" Connections Brass Pop-Up Drain Assembly With 1.2 GPM Laminar Flow Rate	PVD Brushed Nickel	6	\$361.20
	3MO180-WD	Single Handle Lavatory Faucet Metal Lever Handle	Polished Chrome	6	\$247.00
	3MO180-WD-BN	Rigid Spout 4-7/8" Reach, 6" from Deck to Aerator Ceramic Disc Cartridge 1 or 3-Hole 4" Installation Easy-Install 18" Flex Supply Lines With 3/8" Connections Brass Pop-Up Drain Assembly Deck Cover Plate Included With 1.2 GPM Laminar Flow Rate	PVD Brushed Nickel	6	\$366.20

Low flow aerators available upon request.  
\*Special Order. Allow 10-12 weeks delivery

Pioneer faucets feature aerators that meet ANSI/ASME A112.18.1 flow requirements of 1.5 GPM

# MOD // Lavatory Faucets

## SINGLE HANDLE LAVATORY FAUCETS



	Model#	Description	Finish	Case	Price
<b>PARTS</b>	X-1300019	Metal Lever Handle	Polished Chrome	---	\$24.40
	X-3300006	Ceramic Disc Cartridge	---	---	\$12.75
	X-3300007	Ceramic Disc Cartridge	---	---	\$14.25
	X-4300087	Deck Plate	Polished Chrome	---	\$16.50
	X-4300088	Cap	Polished Chrome	---	\$5.25
	X-4300089	Locknut	---	---	\$3.00
	X-4300091	Escutcheon	Polished Chrome	---	\$11.25
	X-4400099	Allen Screw	---	---	\$1.30
	X-4900044	Hole Cover	Polished Chrome	---	\$2.05
	X-5300008	Mounting Kit	---	---	\$16.50
	X-5300012	Mounting Kit	---	---	\$8.40
	X-6300029	Pop-Up Drain Assembly	Polished Chrome	---	\$45.75
	X-4300090	1.5 GPM Aerator	Polished Chrome	---	\$9.00

Low flow aerators available upon request.  
 \*Special Order. Allow 10-12 weeks delivery

Pioneer faucets feature aerators that meet ANSI/ASME A112.18.1 flow requirements of 1.5 GPM

# MOD // Lavatory Faucets

## TWO HANDLE LAVATORY FAUCETS

		Model#	Description	Finish	Case	Price
		<b>3MO200</b>	Two Handle Lavatory Widespread Faucet	Polished Chrome	6	\$367.40
		<b>3MO200-BN</b>	Metal Lever Handle Rigid Spout	PVD Brushed Nickel	6	\$538.30
		<b>3MO200-MB*</b>	4-7/8" Reach, 3-3/8" from Deck to Aerator Ceramic Disc Cartridge 3-Hole 6" to 16" Installation Easy-Install 18" Flex Supply Lines With 3/8" Connections Brass Pop-Up Drain Assembly With 1.2 GPM Laminar Flow Rate	Matte Black	6	\$441.00
<b>PARTS</b>		<b>X-4300093</b>	Red/Blue Index Button	---	---	\$0.75
		<b>X-1300020</b>	Metal Lever Handle	Polished Chrome	---	\$32.50
		<b>X-4300094</b>	Valve Escutcheon	Polished Chrome	---	\$11.25
		<b>X-5900001</b>	Valve Mounting Kit	---	---	\$7.15
		<b>X-4900022</b>	Bonnet Nut	---	---	\$4.35
		<b>X-3900002C</b>	Ceramic Disc Cartridge-Cold	---	---	\$10.70
		<b>X-3900002H</b>	Ceramic Disc Cartridge-Hot	---	---	\$10.70
		<b>X-4900024</b>	3/32" Allen Wrench	---	---	\$1.30
		<b>X-2300021</b>	Square Rigid Spout	Polished Chrome	---	\$172.00
		<b>X-5300003</b>	Spout Mounting Kit	---	---	\$2.80
		<b>X-4300011</b>	Y Connector	---	---	\$16.00
		<b>X-6300030</b>	Pop-up Drain Assembly	Polished Chrome	---	\$47.25
		<b>X-4900002</b>	3/32" Allen Screw	---	---	\$1.30
		<b>X-4900044</b>	Hole Cover	Polished Chrome	---	\$2.05
		<b>X-4300091</b>	Spout Escutcheon	Polished Chrome	---	\$11.25
		<b>X-4300090</b>	1.5 GPM Aerator	Polished Chrome	---	\$9.00

Low flow aerators available upon request.  
\*Special Order. Allow 10-12 weeks delivery

Pioneer faucets feature aerators that meet ANSI/ASME A112.18.1 flow requirements of 1.5 GPM

# MOD // Tub & Shower

## TUB & SHOWER TRIM SETS

	Model#	Description	Finish	Case	Price
	 4MO100T	Single Handle Tub and Shower Trim Set Metal Lever Handle	Polished Chrome	6	\$206.75
	4MO100T-BN	Ceramic Disc Cartridge with Temperature Limit Cap Single Function 6" Square Showerhead 8-7/8" L Shape Shower Arm And Shower Arm Flange Combo 1/2" IPS/Slip-On Diverter Tub Spout With Escutcheon Color Match Sleeve and Retaining Ring With 2.5 GPM Flow Rate  For Use with 4020B Valve - Valve not included	PVD Brushed Nickel	6	\$289.50
	 4MO200T	Single Handle Tub Trim Set Metal Lever Handle	Polished Chrome	6	\$169.00
	4MO200T-BN	Ceramic Disc Cartridge with Temperature Limit Cap Extended Combo 1/2" IPS/Slip-On Tub Spout with Escutcheon Color Match Sleeve and Retaining Ring  For Use with 4020B Valve - Valve not included	PVD Brushed Nickel	6	\$218.00
	 4MO300T	Single Handle Shower Trim Set Metal Lever Handle	Polished Chrome	6	\$170.00
	4MO300T-BN	Ceramic Disc Cartridge with Temperature Limit Stop Single Function 6" Square Showerhead 8-7/8" L Shape Shower Arm And Shower Arm Flange With 2.5 GPM Flow Rate  For Use with 4020B Valve - Valve not included	PVD Brushed Nickel	6	\$219.50
	 4MO400T	Single Handle Valve Trim Set Metal Lever Handle	Polished Chrome	6	\$96.10
	4MO400T-BN	Ceramic Disc Cartridge with Temperature Limit Stop Color Match Sleeve and Retaining Ring  For Use with 4020B Valve - Valve not included	PVD Brushed Nickel	6	\$119.70
	 6MO101T	Single Handle Diverter Trim Set Metal Lever Handle	Polished Chrome	12	\$82.00
	6MO101T-BN	Diverter Valve Face Plate Diverter Valve Sleeve  For Use with 4100B Valve - Valve not included	PVD Brushed Nickel	12	\$92.00



Low flow showerheads available upon request.

Pioneer showerheads meet ANSI/ASME A112.18.1 flow requirements of maximum 1.75 GPM

# MOD // Tub & Shower

## NEW FAUCETS

### TUB & SHOWER TRIM SETS

		Model#	Description	Finish	Case	Price
		4MO110T	Single Handle Tub and Shower Trim Set Lever Handle	Polished Chrome	6	\$189.00
		4MO110T-BN	Ceramic Disc Cartridge with Temperature Limit Cap Single Function 4" Square Showerhead Shower Arm and Flange Extended Combo 1/2" IPS/Slip-On Diverter Tub Spout with Escutcheon Color Match Sleeve and Retaining Ring With 1.75 GPM Flow Rate  For Use with 4020B Valve – Valve not included	PVD Brushed Nickel	6	\$253.00
<b>PARTS</b>		X-6400077	Single Function Square Showerhead	Polished Chrome	---	\$121.00
		X-6400104	Shower Arm	Polished Chrome	---	\$30.00
		X-6400103	Shower Arm Flange	Polished Chrome	---	\$11.45
		X-1400043	Metal Lever Handle	Polished Chrome	---	\$32.50
		X-6400064	Face Plate	Polished Chrome	---	\$39.00
		X-4200001	Retainer Cap	Polished Chrome	---	\$7.40
		X-4400080	Retainer Nut	---	---	\$4.35
		X-4400030	Sleeve	Polished Chrome	---	\$23.35
		X-3400007	Ceramic Disc Cartridge	---	---	\$49.00
		X-4900024	Allen Wrench	---	---	\$1.30
		X-6400086	1/2" Combo Diverter Tub Spout	Polished Chrome	---	\$80.25
		X-4900080	Allen Screw	---	---	\$1.30

Low flow showerheads available upon request.

Pioneer showerheads meet ANSI/ASME A112.18.1 flow requirements of maximum 1.75 GPM

# MOD // Tub & Shower

## NEW FAUCETS

### TUB & SHOWER TRIM SETS

	Model#	Description	Finish	Case	Price
	6MO400	Handheld Shower Set Single Function Handheld Showerhead	Polished Chrome	6	\$349.00
	6MO400-BN	30" Slide Bar with Brass Mounts 60" Stainless Steel Flex Hose Brass Drop Ell with Vacuum Breaker With 1.75 GPM Flow Rate	PVD Brushed Nickel	6	\$439.00

Low flow showerheads available upon request.

Pioneer showerheads meet ANSI/ASME A112.18.1 flow requirements of maximum 1.75 GPM

MOD

# MOD // Tub & Shower

## TWO HANDLE ROMAN TUB TRIM SETS

	Model#	Description	Finish	Case	Price
	4MO610T	Two Handle Roman Tub Trim Set Metal Lever Handle	Polished Chrome	6	\$369.90
	4MO610T-BN	Rigid Spout 6-5/8" Reach 3-Hole 8" to 16" Installation  For Use with 4300B Valve - Valve not included	PVD Brushed Nickel	6	\$465.40

## TWO HANDLE ROMAN TUB SETS

	Model#	Description	Finish	Case	Price
	4MO611	Two Handle Roman Tub Set With Handheld Showerhead Metal Lever Handle	Polished Chrome	4	\$730.80
	4MO611-BN	Rigid Spout 6-5/8" Reach Ceramic Disc Cartridges 4-Hole 8" to 16" Installation Includes Integral Diverter Valve Single Function Handheld Showerhead With 1.75 GPM Flow Rate	PVD Brushed Nickel	4	\$921.70

### PARTS

X-1400044	Metal Lever Handle	Polished Chrome	---	\$32.50
X-2400019	Rigid Spout	Polished Chrome	---	\$333.29
X-2400020	Rigid Diverter Spout	Polished Chrome	---	\$385.00
X-3400004	Diverter Valve	---	---	\$121.66
X-3900002C	Ceramic Disc Cartridge-Cold	---	---	\$10.70
X-3900002H	Ceramic Disc Cartridge-Hot	---	---	\$10.70
X-4400028	Allen Screw	---	---	\$1.30
X-4400058	5/16" Allen Wrench	---	---	\$0.80
X-4400063	Flex Hose Connector	---	---	\$13.45
X-4400073	Hole Cover	Polished Chrome	---	\$3.05
X-4400102	Flow Streamer	Polished Chrome	---	\$4.85
X-4400108	Valve Escutcheon & Sleeve	Polished Chrome	---	\$25.50
X-4400109	Spout Escutcheon	Polished Chrome	---	\$30.00
X-4400106	Handheld Showerhead	Polished Chrome	---	\$78.75
X-4400113	Pull Rod Flange	Polished Chrome	---	\$11.25
X-4400114	Diverter Pull Rod	Polished Chrome	---	\$9.75

Pioneer showerheads meet ANSI/ASME A112.18.1 flow requirements of maximum 1.75 GPM

# MOD // Tub & Shower





## TWO HANDLE ROMAN TUB SETS

	Model#	Description	Finish	Case	Price
<b>PARTS</b>	X-4600006	Handheld Showerhead Hose	Polished Chrome	---	\$120.00
	X-4900002	3/32" Allen Screw	---	---	\$1.30
	X-4900004	Supply Nut	---	---	\$3.30
	X-4900022	Bonnet Nut	---	---	\$4.35
	X-4900024	3/32" Allen Wrench	---	---	\$1.30
	X-4900044	Hole Cover	Polished Chrome	---	\$2.05
	X-4900047	Washer	---	---	\$1.30
	X-5400003	Mounting Kit	---	---	\$16.75
	X-5600004	Mounting Kit	---	---	\$3.85
	X-4400028	5/16" Allen Screw	---	---	\$1.30

MOD

# MOD // Bathroom Hardware

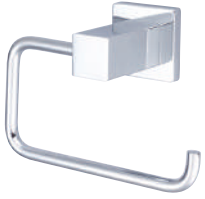

## BATHROOM HARDWARE

		Model#	Description	Finish	Case	Price
		7MO030	Towel Bar 24" Long	Polished Chrome	20	\$72.00
		7MO030-BN	Concealed Screw Installation Mounting Hardware	PVD Brushed Nickel	20	\$93.00
		7MO030-MB*		Matte Black	20	\$86.00
		7MO031	Towel Bar 18" Long	Polished Chrome	20	\$69.30
		7MO031-BN	Concealed Screw Installation Mounting Hardware	PVD Brushed Nickel	20	\$90.30
		7MO031-MB*		Matte Black	20	\$83.00
		7MO032	Toilet Tissue Holder	Polished Chrome	40	\$47.80
		7MO032-BN	Concealed Screw Installation Mounting Hardware	PVD Brushed Nickel	40	\$60.40
		7MO032-MB*		Matte Black	40	\$57.50
		7MO033	Robe Hook	Polished Chrome	40	\$32.60
		7MO033-BN	Concealed Screw Installation Mounting Hardware	PVD Brushed Nickel	40	\$38.90
		7MO033-MB*		Matte Black	40	\$39.00
		7MO034	Towel Ring	Polished Chrome	40	\$43.60
		7MO034-BN	Concealed Screw Installation Mounting Hardware	PVD Brushed Nickel	40	\$56.70
		7MO034-MB*		Matte Black	40	\$52.50

\*Special Order. Allow 10-12 weeks delivery.

# MOTEGI // Kitchen Faucets

## SINGLE HANDLE KITCHEN FAUCETS

	Model#	Description	Finish	Case	Price
	2MT161H	Single Handle Kitchen Faucet Metal Lever Handle	Polished Chrome	6	\$370.00
	2MT161H-BN	Bent Nose Spout Swivel 360° 8-1/2" Reach, 6-7/16" from Deck to Aerator Ceramic Disc Cartridge with Temperature Limit Stop 2-Hole Installation Side Spray Assembly Easy-Install 30" Flex Supply Lines With 3/8" Connections With 1.5 GPM Flow Rate	PVD Brushed Nickel	6	\$396.00
	2MT171H	Single Handle Kitchen Faucet Metal Lever Handle	Polished Chrome	6	\$396.00
	2MT171H-BN	Gooseneck Spout Swivel 360° 7-5/8" Reach, 8-1/2" from Deck to Aerator Ceramic Disc Cartridge with Temperature Limit Stop 2-Hole Installation Side Spray Assembly Easy-Install 30" Flex Supply Lines With 3/8" Connections With 1.5 GPM Flow Rate	PVD Brushed Nickel	6	\$427.00
	2MT182H	Single Handle Kitchen Faucet Metal Lever Handle	Polished Chrome	6	\$292.00
	2MT182H-BN	90 Degree Spout Swivel 360° 8" Reach, 9" from Deck to Aerator Ceramic Disc Cartridge with Temperature Limit Stop 2-Hole Installation Side Spray Assembly Easy-Install 30" Flex Supply Lines With 3/8" Connections With 1.5 GPM Flow Rate	PVD Brushed Nickel	6	\$325.00

Low flow aerators available upon request.







Pioneer faucets feature aerators that meet ANSI/ASME A112.18.1 flow requirements of 1.5 GPM

MOTEGI

# MOTEGI // Kitchen Faucets

## NEW FAUCETS

### SINGLE HANDLE KITCHEN PULL-DOWN FAUCETS



	Model#	Description	Finish	Case	Price
	  2MT250	Single Handle Pull-Down Kitchen Faucet Metal Lever Handle	Polished Chrome	6	\$425.00
	2MT250-BN	Pull-Down Head with 2 Spray Patterns Swivel 360° 8-9/16" Reach, 10-1/16" from Deck to Aerator	PVD Brushed Nickel	6	\$469.00
	2MT250-SS	Ceramic Disc Cartridge with Temperature Limit Stop 1 or 3 Hole 8" Installation Easy-Install 30" Flex Supply Lines With 3/8" Connections Ball Joint Swivel Sprayhead With 1.8 GPM Flow Rate	PVD Stainless Steel	6	\$469.00
	2MT251	Same as Above with 1 Hole Installation Option Only	Polished Chrome	6	\$394.00
	2MT251-BN		PVD Brushed Nickel	6	\$434.00
	   2MT260	Single Handle Pull-Down Kitchen Faucet Metal Lever Handle	Polished Chrome	6	\$447.00
	2MT260-BN	Pull-Down Head with 2 Spray Patterns Swivel 360° 8-9/16" Reach, 9-15/16" from Deck to Aerator Ceramic Disc Cartridge with Temperature Limit Stop 1 or 3 Hole 8" Installation Ball Joint Swivel Sprayhead Easy-Install 30" Flex Supply Lines With 3/8" Connections With 1.8 GPM Flow Rate	PVD Brushed Nickel	6	\$492.00
	2MT261	Same as Above with 1 Hole Installation Option Only	Polished Chrome	6	\$416.00
	 2MT270	Single Handle Pull-Down Pre-Rinse Kitchen Faucet Metal Lever Handle	Polished Chrome	4	\$465.00
	2MT270-BN	Pull-Down Head with 2 Spray Patterns Swivel 360° 9" Reach, 7" from Deck to Aerator 22-3/4" Overall Height Ceramic Disc Cartridge with Temperature Limit Cap 1-Hole Installation Optional 3-Hole 8" Deck Plate Available Easy-Install 30" Flex Supply Lines With 3/8" Connections With 1.8 GPM Flow Rate	PVD Brushed Nickel	4	\$555.00
	 2MT275	Single Handle Pull-Down Pre-Rinse Kitchen Faucet Metal Lever Handle	Polished Chrome	4	\$449.00
	2MT275-BN	Pull-Down Head with 2 Spray Patterns Swivel 360° 9" Reach, 7" from Deck to Aerator 19-3/4" Overall Height Ceramic Disc Cartridge with Temperature Limit Cap 1-Hole Installation Optional 3-Hole 8" Deck Plate Available Easy-Install 30" Flex Supply Lines With 3/8" Connections With 1.8 GPM Flow Rate	PVD Brushed Nickel	4	\$536.00

Low flow aerators available upon request.

Pioneer faucets feature aerators that meet ANSI/ASME A112.18.1 flow requirements of 1.8 GPM

# MOTEGI // Kitchen Faucets

## POT FILLERS

	Model#	Description	Finish	Case	Price
	 	<b>2MT600</b> Wall Mount Pot Filler Metal Lever Handles	Polished Chrome	6	\$376.00
		<b>2MT600-BN</b> Space Saving Swivel Spout folds in when not in use 23-9/16" Spout Reach	PVD Brushed Nickel	6	\$402.00
		<b>2MT600-SS</b> Ceramic Disc Cartridges 1-Hole Wall Mount Installation Designed for Cold Water 1/2" IPS Connection with Flange With 2.0 GPM Flow Rate	PVD Stainless Steel	6	\$402.00

Pioneer faucets feature aerators that meet ANSI/ASME A112.18.1 flow requirements of 2.0 GPM





# MOTEGI // Kitchen Faucets

## SINGLE HANDLE KITCHEN PULL-DOWN FAUCETS & POT FILLERS



	Model#	Description	Finish	Case	Price
<b>PARTS</b>	X-1200011	Handle Set	Polished Chrome	---	\$22.35
	X-1200012	Handle Set	Polished Chrome	---	\$24.40
	X-1200018	Handle Set	Polished Chrome	---	\$31.50
	X-1200019	Secondary Handle Set	Polished Chrome	---	\$26.40
	X-1900008	Handle Set	Polished Chrome	---	\$22.35
	X-2200014	Gooseneck Spout Set	Polished Chrome	---	\$179.00
	X-2200015	90 Degree Spout Set	Polished Chrome	---	\$192.00
	X-2200017	Gooseneck Spout Set	Polished Chrome	---	\$179.00
	X-2200018	Bent Nose Spout Set	Polished Chrome	---	\$79.00
	X-2200019	Gooseneck Spout Set	Polished Chrome	---	\$99.00
	X-3200001	Ceramic Disc Cartridge	---	---	\$16.00
	X-3200004H	Ceramic Stem-Hot	---	---	\$24.40
	X-3900001	Ceramic Disc Cartridge With Temperature Limit Stop	---	---	\$13.20
	X-4200007	Diverter Piston	---	---	\$2.30
	X-4200016	Diverter Piston	---	---	\$8.09
	X-4200070	Side Spray	Polished Chrome	---	\$185.99
	X-4200180	Spray Head-1.8 GPM	Polished Chrome	---	\$57.17
	X-4900089	Aerator-1.5 GPM-Male	Polished Chrome	---	\$6.60
	X-4900072	Aerator-1.0 GPM-Male	Polished Chrome	---	\$7.65
	X-4900073	Aerator-0.5 GPM-Male	Polished Chrome	---	\$14.75
X-4200181	Spray Head-1.8 GPM	Polished Chrome	---	\$ 49.00	

# MOTEGI // Lavatory Faucets

## SINGLE HANDLE LAVATORY FAUCETS

	Model#	Description	Finish	Case	Price
	3MT161	Single Handle Lavatory Faucet Metal Lever Handle	Polished Chrome	6	\$185.00
	3MT161-BN	Bent Nose Spout 5-5/8" Reach, 1-3/4" from Deck to Aerator Ceramic Disc Cartridge with Temperature Limit Stop 1-Hole Installation Easy-Install 18" Flex Supply Lines With 3/8" Connections With 1.2 GPM Flow Rate	PVD Brushed Nickel	6	\$197.00
	3MT161G	Single Handle Lavatory Faucet Metal Lever Handle	Polished Chrome	6	\$210.00
	3MT161G-BN	Bent Nose Spout 5-5/8" Reach, 1-3/4" from Deck to Aerator Ceramic Disc Cartridge with Temperature Limit Stop 1-Hole Installation Easy-Install 18" Flex Supply Lines With 3/8" Connections Brass Grid Strainer Drain Assembly With 1.2 GPM Flow Rate	PVD Brushed Nickel	6	\$222.00
	3MT160	Single Handle Lavatory Faucet Metal Lever Handle	Polished Chrome	6	\$218.00
	3MT160-BN	Bent Nose Spout 5-5/8" Reach, 1-3/4" from Deck to Aerator Ceramic Disc Cartridge with Temperature Limit Stop 1-Hole Installation Easy-Install 18" Flex Supply Lines With 3/8" Connections Brass Pop-Up Drain Assembly With 1.2 GPM Flow Rate	PVD Brushed Nickel	6	\$226.00
	3MT160B*	*Builder Tract Pack	Polished Chrome	6	\$216.00
	3MT168	Single Handle Lavatory Faucet Metal Lever Handle	Polished Chrome	6	\$248.00
	3MT168-BN	Bent Nose Spout 5-5/8" Reach, 9-3/4" from Deck to Aerator Ceramic Disc Cartridge with Temperature Limit Stop 1-Hole Installation Easy-Install 18" Flex Supply Lines With 3/8" Connections With 1.2 GPM Flow Rate	PVD Brushed Nickel	6	\$260.00
	3MT168-ORB*	Oil Rubbed Bronze	6	\$289.00	

## TWO HANDLE LAVATORY FAUCETS

	Model#	Description	Finish	Case	Price
	3MT500	Two Handle Lavatory Widespread Faucet Metal Lever Handles	Polished Chrome	6	\$381.00
	3MT500-BN	Bent Nose Spout 6-1/2" Reach, 1-3/4" from Deck to Aerator Ceramic Disc Cartridges 3-Hole 6" to 16" Installation Brass Pop-Up Drain Assembly Includes Spout and Valve Escutcheons With 1.2 GPM Flow Rate	PVD Brushed Nickel	6	\$402.00
	3MT420	Two Handle Lavatory Widespread Faucet Metal Lever Handles	Polished Chrome	6	\$320.00
	3MT420-BN	90 Degree Spout 5-1/2" Reach, 2-1/2" from Deck to Aerator Ceramic Disc Cartridges 3-Hole 6" to 16" Installation Brass Pop-Up Drain Assembly With 1.2 GPM Flow Rate	PVD Brushed Nickel	6	\$352.00

Builder Tract Packs sold in case quantities only.

Low flow aerators available upon request.

\*Special Order. Allow 10-12 weeks delivery.



www.pioneerind.com

Pioneer faucets feature aerators that meet ANSI/ASME A112.18.1 flow requirements of 1.2 GPM



# MOTEGI // Lavatory Faucets

## SINGLE HANDLE LAVATORY FAUCETS

	Model#	Description	Finish	Case	Price
	3MT170	Single Handle Lavatory Faucet Metal Lever Handle	Polished Chrome	6	\$218.00
	3MT170-BN	Straight Spout	PVD Brushed Nickel	6	\$226.00
	3MT170-MB	3-3/4" Reach, 2-7/8" from Deck to Aerator Ceramic Disc Cartridge with Temperature Limit Stop	Matte Black	6	\$248.00
	3MT170B*	1-Hole Installation Easy-Install 18" Flex Supply Lines With 3/8" Connections Brass Pop-Up Drain Assembly With 1.2 GPM Flow Rate  *Builder Tract Pack	Polished Chrome	6	\$216.00
	3MT178	Single Handle Lavatory Faucet Metal Lever Handle Straight Spout 3-3/4" Reach, 10-7/8" from Deck to Aerator Ceramic Disc Cartridge with Temperature Limit Stop 1-Hole Installation Easy-Install 18" Flex Supply Lines With 3/8" Connections With 1.2 GPM Flow Rate  *Builder Tract Pack	Polished Chrome	6	\$248.00
	3MT180	Single Handle Lavatory Faucet Metal Lever Handle	Polished Chrome	6	\$318.00
	3MT180-BN	Gooseneck Spout Swivel 90°	PVD Brushed Nickel	6	\$334.00
	3MT180-MB	5-1/2" Reach, 8-1/2" from Deck to Aerator Ceramic Disc Cartridge with Temperature Limit Stop 1-Hole Installation Brass Pop-Up Drain Assembly Easy-Install 18" Flex Supply Lines With 3/8" Connections With 1.2 GPM Flow Rate	Matte Black	6	\$348.00

## TWO HANDLE LAVATORY FAUCETS

	Model#	Description	Finish	Case	Price
	3MT400	Two Handle Lavatory Widespread Faucet Metal Lever Handles	Polished Chrome	6	\$381.00
	3MT400-BN	Gooseneck Spout Swivel 90° 5-1/2" Reach, 7" from Deck to Aerator Ceramic Disc Cartridges 3-Hole 6" to 16" Installation Brass Pop-Up Drain Assembly With 1.2 GPM Laminar Flow Rate	PVD Brushed Nickel	6	\$402.00

Builder Tract Packs sold in case quantities only.  
Low flow aerators available upon request.  
\*Special Order. Allow 10-12 weeks delivery.

Pioneer faucets feature aerators that meet ANSI/ASME A112.18.1 flow requirements of 1.2 GPM

# MOTEGI // Lavatory Faucets

## SINGLE HANDLE LAVATORY FAUCETS



	Model#	Description	Finish	Case	Price
	3MT800	Single Handle Lavatory Wall Mount Vessel Filler Metal Lever Handle	Polished Chrome	6	\$263.70
	3MT800-BN	Bent Nose Spout 10" Reach	PVD Brushed Nickel	6	\$271.00
	3MT800-MB*	Ceramic Disc Cartridge with Temperature Limit Stop 2-Hole 4" Installation Includes Valve with Mounting Plate With 1.2 GPM Flow Rate	Matte Black	6	\$282.00
	3MT800T**	**Trim only option for use with 4200B	Polished Chrome	6	\$129.80
	3MT800T-BN**		PVD Brushed Nickel	6	\$137.10
	<b>PARTS</b>	X-1300006	Handle Set	Polished Chrome	---
X-1900008		Handle Set	Polished Chrome	---	\$22.35
X-2300004		Gooseneck Spout Set	Polished Chrome	---	\$158.00
X-2300005		Bent Nose Spout Set	Polished Chrome	---	\$81.00
X-2300006		Gooseneck Spout Set	Polished Chrome	---	\$88.00
X-3900001		Ceramic Disc Cartridge With Temperature Limit Stop	---	---	\$13.20
X-3900002C		Ceramic Stem-Cold	---	---	\$10.70
X-3900002H		Ceramic Stem-Hot	---	---	\$10.70
X-4300022		8" Extension Base	Polished Chrome	---	\$90.00
X-4300043		Brass Pop-Up	Polished Chrome	---	\$45.00
X-6300002		Brass Grid Strainer	Polished Chrome	---	\$51.00
X-6300006		Brass Pop-Up	Polished Chrome	---	\$39.00
X-4900041		Aerator-2.0 GPM-Male	Polished Chrome	---	\$4.85
X-4900072		Aerator-1.0 GPM-Male	Polished Chrome	---	\$7.65
X-4900073		Aerator-0.5 GPM-Male	Polished Chrome	---	\$14.75
X-4900089		Aerator-1.5 GPM-Male	Polished Chrome	---	\$6.60

Low flow aerators available upon request.  
\*Special Order. Allow 10-12 weeks delivery.

Pioneer faucets feature aerators that meet ANSI/ASME A112.18.1 flow requirements of 1.5 GPM

# MOTEGI // Tub & Shower

## TUB & SHOWER TRIM SETS











	Model#	Description	Finish	Case	Price
	4MT110T	Single Handle Tub and Shower Trim Set Metal Lever Handle	Polished Chrome	6	\$376.00
	4MT110T-BN	Ceramic Disc Cartridge with Temperature Limit Stop	PVD Brushed Nickel	6	\$396.00
	4MT110T-MB*	Five Function 3" Diameter Showerhead Shower Arm and Flange 1/2" IPS Diverter Tub Spout 7-1/4" Spout Reach Color Match Sleeve and Retaining Ring With 1.75 GPM Flow Rate  For Use with 4020B Valve - Valve not included	Matte Black	6	\$406.00
	4MT200T	Single Handle Tub Trim Set Metal Lever Handle	Polished Chrome	6	\$287.00
	4MT200T-BN	Ceramic Disc Cartridge with Temperature Limit Stop 1/2" IPS Tub Spout with Escutcheon 6-1/8" Spout Reach Color Match Sleeve and Retaining Ring  For Use with 4020B Valve - Valve not included	PVD Brushed Nickel	6	\$308.00
	4MT300T	Single Handle Shower Trim Set Metal Lever Handle	Polished Chrome	6	\$229.50
	4MT300T-BN	Ceramic Disc Cartridge with Temperature Limit Stop Five Function 3" Diameter Showerhead Shower Arm and Flange Color Match Sleeve and Retaining Ring With 1.75 GPM Flow Rate  For Use with 4020B Valve - Valve not included	PVD Brushed Nickel	6	\$297.00

Low flow showerheads available upon request.  
\*Special Order. Allow 10-12 weeks delivery.

Pioneer showerheads meet ANSI/ASME A112.18.1 flow requirements of maximum 1.75 GPM

# MOTEGI // Tub & Shower

## TUB & SHOWER TRIM SETS

	Model#	Description	Finish	Case	Price
	  <b>4MT120T</b>	Single Handle Tub and Shower Trim Set Metal Lever Handle	Polished Chrome	6	\$349.00
	<b>4MT120T-BN</b>	Ceramic Disc Cartridge with Temperature Limit Stop Single Function 3-3/8" Diameter Showerhead Shower Arm and Flange 1/2" IPS Diverter Tub Spout 7-1/4" Spout Reach Color Match Sleeve and Retaining Ring With 1.75 GPM Flow Rate  For Use with 4020B Valve - Valve not included	PVD Brushed Nickel	6	\$370.00
	  <b>4MT320T</b>	Single Handle Shower Trim Set Metal Lever Handle	Polished Chrome	6	\$194.00
	<b>4MT320T-BN</b>	Ceramic Disc Cartridge with Temperature Limit Stop Single Function 3-3/8" Diameter Showerhead Shower Arm and Flange Color Match Sleeve and Retaining Ring With 1.75 GPM Flow Rate  For Use with 4020B Valve - Valve not included	PVD Brushed Nickel	6	\$271.00
	 <b>4MT400T</b>	Single Handle Valve Trim Set Metal Lever Handle	Polished Chrome	6	\$183.00
	<b>4MT400T-BN</b>	Ceramic Disc Cartridge with Temperature Limit Stop Color Match Sleeve and Retaining Ring  For Use with 4020B Valve - Valve not included	PVD Brushed Nickel	6	\$203.00
	 <b>6MT101T</b>	Single Handle Diverter Trim Set Metal Lever Handle	Polished Chrome	12	\$78.00
	<b>6MT101T-BN</b>	Diverter Valve Face Plate Diverter Valve Sleeve  For Use with 4100B Valve - Valve not included	PVD Brushed Nickel	12	\$87.00



Low flow showerheads available upon request.

Pioneer showerheads meet ANSI/ASME A112.18.1 flow requirements of maximum 1.75 GPM

MOTEGI

# MOTEGI // Tub & Shower

## TUB & SHOWER TRIM SETS



	Model#	Description	Finish	Case	Price
	4MT111T	Single Handle Tub and Shower Trim Set Metal Lever Handle	Polished Chrome	6	\$264.00
	4MT111T-LS*	Ceramic Disc Cartridge with Temperature Limit Stop Five Function 3" Diameter Showerhead Shower Arm and Flange Combo 1/2" IPS/Slip-On Diverter Tub Spout, 7" Spout Reach Color Match Sleeve and Retaining Ring With 1.75 GPM Flow Rate  For Use with 4020B Valve - Valve not included  *Less showerhead	Polished Chrome	6	\$214.00
	4MT115T	Single Handle Tub and Shower Trim Set Metal Lever Handle	Polished Chrome	6	\$479.00
	4MT115T-BN	Ceramic Disc Cartridge with Temperature Limit Cap Single Function 8" Diameter Rain Showerhead 15" L Shape Shower Arm And Shower Arm Flange 1/2" IPS Diverter Tub Spout, 7-1/4" Spout Reach Color Match Sleeve and Retaining Ring With 2.5 GPM Flow Rate  For Use with 4020B Valve - Valve not included	PVD Brushed Nickel	6	\$619.00
<b>PARTS</b>	X-1400028	Handle Set	Polished Chrome	---	\$37.00
	X-1600001	Diverter Handle Set	Polished Chrome	---	\$31.50
	X-4400043	Face Plate	Polished Chrome	---	\$80.00
	X-4600011	Diverter Valve Flange Set	Polished Chrome	---	\$40.00
	X-6400095	3" Five Function Showerhead	Polished Chrome	---	\$60.00
	X-6400011	Shower Arm Flange	Polished Chrome	---	\$15.00
	X-6400024	Tub Spout	Polished Chrome	---	\$96.00
	X-6400051	Diverter Tub Spout	Polished Chrome	---	\$202.00
	X-6400081	Showerhead	Polished Chrome	---	\$25.40

Low flow showerheads available upon request.

Pioneer showerheads meet ANSI/ASME A112.18.1 flow requirements of maximum 2.5 GPM

# MOTEGI // Tub & Shower

## HANDHELD SHOWER SETS

	Model#	Description	Finish	Case	Price
	6MT400	Handheld Shower Set Single Function Handheld Showerhead	Polished Chrome	6	\$412.00
	6MT400-BN	25" Slide Bar with Brass Mounts 60" Stainless Steel Flex Hose Brass Drop Ell with Vacuum Breaker With 1.75 GPM Flow Rate	PVD Brushed Nickel	6	\$427.00
	6MT410	Handheld Shower Set Single Function Handheld Showerhead	Polished Chrome	6	\$198.00
	6MT410-BN	60" Stainless Steel Flex Hose Wall Mount Bracket with Vacuum Breaker With 1.75 GPM Flow Rate	PVD Brushed Nickel	6	\$209.00
<b>PARTS</b>	X-4600003	Handheld Shower Slide Bar and slider	Polished Chrome	---	\$99.00
	X-4600006	Handheld Shower Hose	Polished Chrome	---	\$120.00
	X-4600015	Handheld Shower Drop Ell	Polished Chrome	---	\$59.00
	X-4600016	Handheld Shower Slide Bar Brass Mount	Polished Chrome	---	\$90.00
	X-4600031	Drop Ell With Handheld Support	Polished Chrome	---	\$56.00
	X-4600032	Flange	Polished Chrome	---	\$20.05
	X-4900112	Handheld Shower-1.75 GPM	Polished Chrome	---	\$91.49

Low flow showerheads available upon request.

Pioneer showerheads meet ANSI/ASME A112.18.1 flow requirements of maximum 1.75 GPM

MOTEGI

# MOTEGI // Tub & Shower

## TWO HANDLE ROMAN TUB SETS





	Model#	Description	Finish	Case	Price
	4MT610	Two Handle Roman Tub Set Metal Lever Handles	Polished Chrome	4	\$444.00
	4MT610-BN	Rigid Bent Nose Spout 9-3/8" Reach Ceramic Disc Cartridges 3-Hole 8" to 16" Installation Includes Spout and Valve Escutcheons	PVD Brushed Nickel	4	\$464.00

## SINGLE HANDLE ROMAN TUB SETS

	Model#	Description	Finish	Case	Price
	4MT840	Single Handle Wall Mount Roman Tub Set Metal Lever Handle	Polished Chrome	6	\$313.00
	4MT840-BN	Rigid Bent Nose Spout 10" Reach Ceramic Disc Cartridge with Temperature Limit Stop 2-Hole 4" Installation Includes Valve with Mounting Plate	PVD Brushed Nickel	6	\$329.00
	4MT840T**	**Trim Only option for use with 4200B	Polished Chrome	6	\$179.10
	4MT840T-BN**		PVD Brushed Nickel	6	\$195.10
<b>PARTS</b>	X-1400006	Handle Set	Polished Chrome	---	\$42.00
	X-1900008	Handle Set	Polished Chrome	---	\$22.35
	X-2400001	Spout Set	Polished Chrome	---	\$103.00
	X-2400007	Bent Nose Spout Set	Polished Chrome	---	\$215.00
	X-3900001	Ceramic Disc Cartridge With Temperature Limit Stop	---	---	\$13.20
	X-3900002C	Ceramic Stem-Cold	---	---	\$10.70
	X-3900002H	Ceramic Stem-Hot	---	---	\$10.70
	X-2400021	Spout Set	Polished Chrome	---	\$130.00

# MOTEGI // Bathroom Hardware

## BATHROOM HARDWARE



	Model#	Description	Finish	Case	Price
	7MT030	Towel Bar 24" Long	Polished Chrome	20	\$120.00
	7MT030-BN	Brass Mount Concealed Screw Installation Mounting Hardware	PVD Brushed Nickel	20	\$127.00
	7MT031	Towel Bar 18" Long Brass Mount Concealed Screw Installation Mounting Hardware	Polished Chrome	20	\$110.00
	7MT032	Toilet Tissue Holder Brass Mount	Polished Chrome	40	\$63.00
	7MT032-BN	Concealed Screw Installation Mounting Hardware	PVD Brushed Nickel	40	\$67.00
	7MT033	Robe Hook Brass Mount Concealed Screw Installation Mounting Hardware	Polished Chrome	40	\$63.00

\*Special Order. Allow 10-12 weeks delivery.

MOTEGI

# LEGACY // Kitchen Faucets

## SINGLE HANDLE KITCHEN FAUCETS

	Model#	Description	Finish	Case	Price
	2LG160	Single Handle Kitchen Faucet Metal Lever Handle Spout Swivel 360° 9-11/16" Reach, 5-7/8" from Deck to Aerator Ceramic Disc Cartridge with Temperature Limit Stop 3-Hole 8" Installation With 1.5 GPM Flow Rate	Polished Chrome	12	\$142.00
	2LG160B	Builder Tract Pack	Polished Chrome	12	\$140.00
	2LG160H	30" SS Flex Connectors with 3/8" Compression Connection Nuts	Polished Chrome	12	\$144.00
	2LG160H-BN		PVD Brushed Nickel	12	\$156.00
	2LG161	Single Handle Kitchen Faucet Metal Lever Handle Spout Swivel 360° 9-11/16" Reach, 5-7/8" from Deck to Aerator Ceramic Disc Cartridge with Temperature Limit Stop 4-Hole 8" Installation Side Spray Assembly With 1.5 GPM Flow Rate	Polished Chrome	12	\$174.00
	2LG161-BN		PVD Brushed Nickel	12	\$189.00
	2LG161B	Builder Tract Pack	Polished Chrome	12	\$172.00
	2LG161B-BN		PVD Brushed Nickel	12	\$187.00
	2LG161H	30" SS Flex Connectors with 3/8" Compression Connection Nuts	Polished Chrome	12	\$176.00
	2LG161H-BN		PVD Brushed Nickel	12	\$191.00
	2LG162	Single Handle Kitchen Faucet Metal Lever Handle Spout Swivel 360° 9-11/16" Reach, 5-7/8" from Deck to Aerator Ceramic Disc Cartridge with Temperature Limit Stop 3-Hole 8" Installation Side Spray Assembly on Deck With 1.5 GPM Flow Rate	Polished Chrome	12	\$174.00
	<b>PARTS</b>				
	X-1200001	Lever Handle	Polished Chrome	---	\$22.35
	X-1200002	Loop Handle	Polished Chrome	---	\$22.35
	X-2200001	Spout Set	Polished Chrome	---	\$65.00
	X-3900001	Ceramic Disc Cartridge	---	---	\$13.20
	X-4200001	Retainer Cap	Polished Chrome	---	\$7.40
	X-4200002	Retainer Nut	---	---	\$4.60
	X-4200003	Spout Gasket	---	---	\$0.80
	X-4200004	Spout O-Ring	---	---	\$1.30
	X-4200005	Deck Plate	Polished Chrome	---	\$30.45
	X-4200006	Deck Plate Mounting Gasket	---	---	\$2.30
	X-4200007	Diverter Piston	---	---	\$2.30
	X-4200008	Side Spray Assembly	Polished Chrome	---	\$67.16
	X-4200009	Side Spray Assembly On Deck	Polished Chrome	---	\$42.00
	X-4200010	Deck Plate For Spray On Deck Faucet	Polished Chrome	---	\$29.45
	X-4900001	Hot & Cold Indicator	---	---	\$1.05
	X-4900002	3/32" Allen Screw	---	---	\$1.30
	X-4900004	Supply Nut	---	---	\$3.30
	X-5200006	Mounting Kit	---	---	\$2.30
	X-4900081	1.5 GPM Aerator	Polished Chrome	---	\$8.90



Builder Tract Packs sold in case quantities only.  
Low flow aerators available upon request.

Pioneer faucets feature aerators that meet ANSI/ASME A112.18.1 flow requirements of 1.5 GPM

\*Special Order. Allow 10-12 weeks delivery.

# LEGACY // Kitchen Faucets

## SINGLE HANDLE KITCHEN FAUCETS

	Model#	Description	Finish	Case	Price
	2LG260	Single Handle Kitchen Faucet Metal Lever Handle	Polished Chrome	12	\$144.00
	2LG260-BN	Spout Swivel 360° 9-11/16" Reach, 5-7/8" from Deck to Aerator Ceramic Disc Cartridge with Temperature Limit Stop 1-Hole Installation With 1.5 GPM Flow Rate	PVD Brushed Nickel	12	\$155.00
	2LG261	Single Handle Kitchen Faucet Metal Lever Handle Spout Swivel 360° 9-11/16" Reach, 5-7/8" from Deck to Aerator Ceramic Disc Cartridge with Temperature Limit Stop 2-Hole Installation Side Spray Assembly With 1.5 GPM Flow Rate	Polished Chrome	12	\$176.00
<b>PARTS</b>	X-1200001	Lever Handle	Polished Chrome	---	\$22.35
	X-1200002	Loop Handle	Polished Chrome	---	\$22.35
	X-2200001	Spout Set	Polished Chrome	---	\$65.00
	X-3900001	Ceramic Disc Cartridge	---	---	\$13.20
	X-4200001	Retainer Cap	Polished Chrome	---	\$7.40
	X-4200002	Retainer Nut	---	---	\$4.60
	X-4200003	Spout Gasket	---	---	\$0.80
	X-4200004	Spout O-Ring	---	---	\$1.30
	X-4200109	Escutcheon	Polished Chrome	---	\$25.40
	X-4200005	Deck Plate	Polished Chrome	---	\$30.45
	X-4200006	Deck Plate Mounting Gasket	---	---	\$2.30
	X-4200007	Diverter Piston	---	---	\$2.30
	X-4200008	Side Spray (For 2LG161, 2LG161H, 2LG171)	---	---	\$67.16
	X-4200009	Side Spray Assembly	Polished Chrome	---	\$42.00
	X-4200010	Deck Plate	Polished Chrome	---	\$29.45
	X-4900001	Hot & Cold Indicator	Polished Chrome	---	\$1.05
	X-4900002	Allen Screw	---	---	\$1.30
	X-4900004	Supply Nut	---	---	\$3.30
	X-5200006	Mounting Kit	---	---	\$2.30
	X-5200015	Mounting Kit	---	---	\$7.40
X-4900081	1.5 GPM Aerator	Polished Chrome	---	\$8.90	

Low flow aerators available upon request.

Pioneer faucets feature aerators that meet ANSI/ASME A112.18.1 flow requirements of 1.5 GPM

# LEGACY // Kitchen Faucets

## SINGLE HANDLE KITCHEN FAUCETS



	Model#	Description	Finish	Case	Price
	2LG250	Single Handle Pull-Down Kitchen Faucet Metal Lever Handle	Polished Chrome	6	\$329.00
	2LG250-BN	Pull-Down Head with 2 Spray Patterns Swivel 360° 8-1/2" Reach, 8" from Deck to Aerator	PVD Brushed Nickel	6	\$354.00
	2LG250-ORB*	Ceramic Disc Cartridge with Temperature Limit Stop 1 or 3 Hole 8" Installation Ball Joint Swivel Sprayhead Easy-Install 30" Flex Supply Lines With 3/8" Connections With 1.8 GPM Flow Rate	Oil Rubbed Bronze	6	\$363.00
<b>PARTS</b>	X-4200089	Pull-Down Spray Head-2.0 GPM	Polished Chrome	---	\$37.44
	X-4200111	Spray Hose	Polished Chrome	---	\$24.40
	X-4200112	Spout Repair Kit	---	---	\$1.55
	X-3900001	Ceramic Disc Cartridge	---	---	\$13.20
	X-4200002	Retainer Nut	---	---	\$4.60
	X-4200001	Retainer Sleeve	Polished Chrome	---	\$7.40
	X-1200016	Lever Handle	Polished Chrome	---	\$19.05
	X-4200113	Washer	---	---	\$0.80
	X-5200019	Mounting Kit	---	---	\$4.98
	X-4200041	Weight	---	---	\$8.90
	X-4200169	Deck Plate	Polished Chrome	---	\$32.50
	X-4200152	Escutcheon	Polished Chrome	---	\$23.35
	X-5200021	Mounting Tool	---	---	\$7.40
	X-4400024	Allen Screw	---	---	\$1.30
	X-4400073	Hole Cover	Polished Chrome	---	\$3.05

Low flow aerators available upon request.  
\*Special Order. Allow 10-12 weeks delivery.

Pioneer faucets feature aerators that meet ANSI/ASME A112.18.1 flow requirements of 1.8 GPM

# LEGACY // Kitchen Faucets

## TWO HANDLE KITCHEN FAUCETS





	Model#	Description	Finish	Case	Price
	2LG110	Two Handle Kitchen Faucet Mini Blade Handles Spout Swivel 360° 9-11/16" Reach, 5-1/4" from Deck to Aerator Ceramic Disc Cartridges 3-Hole 8" Installation With 1.5 GPM Flow Rate	Polished Chrome	12	\$134.00
	2LG240	Two Handle Kitchen Faucet ADA Wrist Blade Handles Hi-Arc Spout Swivel 360° 7-3/16" Reach, 11-3/16" from Deck to Aerator Ceramic Disc Cartridges 3-Hole 8" Installation With 1.5 GPM Flow Rate	Polished Chrome	6	\$140.00
<b>PARTS</b>	X-1900002C	Mini Blade Handle-Cold	Polished Chrome	---	\$10.95
	X-1900002H	Mini Blade Handle-Hot	Polished Chrome	---	\$10.95
	X-1900003C	ADA Wrist Blade Handle-Cold	Polished Chrome	---	\$18.30
	X-1900003H	ADA Wrist Blade Handle-Hot	Polished Chrome	---	\$18.30
	X-2200002	Spout Set	Polished Chrome	---	\$65.00
	X-2200003	High Rise Spout Set	Polished Chrome	---	\$68.00
	X-3900002C	Ceramic Stem-Cold	---	---	\$10.70
	X-3900002H	Ceramic Stem-Hot	---	---	\$10.70
	X-4200006	Base Plate	---	---	\$2.30
	X-4200011	Retainer Nut & Washer	---	---	\$3.30
	X-4200012	Spout O-Ring	---	---	\$1.30
	X-4200013	Spout Gasket	---	---	\$1.57
	X-4200014	Deck Plate	Polished Chrome	---	\$24.40
	X-4200015	Base Plate	---	---	\$3.84
	X-4200017	Spout Sleeve	Polished Chrome	---	\$22.36
	X-4200058	Cap	Polished Chrome	---	\$5.85
	X-4900004	Supply Nut	---	---	\$3.30
	X-4900007	Bonnet Nut	---	---	\$1.80
	X-4900008	Mounting Kit	---	---	\$1.30
	X-4900009C	Mini Blade Handle Index-Cold	---	---	\$1.30
	X-4900009H	Mini Blade Handle Index-Hot	---	---	\$1.30
	X-4900010	ADA Wrist Blade Handle Screw	---	---	\$1.30
	X-4900011C	Index-Cold	---	---	\$0.80
	X-4900011H	Index-Hot	---	---	\$0.80
	X-4900012	Spout O-Ring	---	---	\$1.30
	X-4900013	Spout Snap Ring	---	---	\$1.30
	X-4900066	Mini Blade Handle Screw	---	---	\$1.30
	X-4900081	1.5 GPM Aerator	Polished Chrome	---	\$8.90
	X-4900082	1.0 GPM Aerator	Polished Chrome	---	\$9.40
	X-4900083	0.5 GPM Aerator	Polished Chrome	---	\$13.20

Builder Tract Packs sold in case quantities only.  
Low flow aerators available upon request.  
\*Special Order. Allow 10-12 weeks delivery.

Pioneer faucets feature aerators that meet ANSI/ASME A112.18.1 flow requirements of 1.5 GPM

# LEGACY // Bar Faucets

## TWO HANDLE BAR FAUCETS







	Model#	Description	Finish	Case	Price
	 5LG120	Two Handle Bar Faucet ADA Wrist Blade Handles Gooseneck Spout Swivel 360° 5-3/16" Reach, 5-7/8" from Deck to Aerator Ceramic Disc Cartridges 2 or 3-Hole 4" Installation With 1.5 GPM Flow Rate	Polished Chrome	12	\$104.00
	 5LG220	Two Handle Bar Faucet ADA Wrist Blade Handles Gooseneck Spout Swivel 360° 3-5/8" Reach, 7" from Deck to Aerator Ceramic Disc Cartridges 2 or 3-Hole 4" Installation With 1.5 GPM Flow Rate	Polished Chrome	12	\$106.00
<b>PARTS</b>	X-1900003C	ADA Wrist Blade Handle-Cold	Polished Chrome	---	\$18.30
	X-1900003C	ADA Wrist Blade Handle-Cold	Polished Chrome	---	\$18.30
	X-1900003H	ADA Wrist Blade Handle-Hot	Polished Chrome	---	\$18.30
	X-4900037	Bonnet Nut	---	---	\$1.95
	X-4900116	Gasket	---	---	\$0.70
	X-3900002C	Ceramic Stem - Cold	---	---	\$10.70
	X-3900002H	Ceramic Stem - Hot	---	---	\$10.70
	X-4500002	Deck Plate	Polished Chrome	---	\$14.50
	X-4500003	Base Plate	---	---	\$1.80
	X-4900008	Mounting Kit	---	---	\$1.30
	X-4900004	Supply Nut	---	---	\$3.30
	X-2500001	5-3/16" Reach Gooseneck Spout	Polished Chrome	---	\$45.00
	X-2500002	3-5/8" Reach Gooseneck Spout	Polished Chrome	---	\$52.00
	X-4900010	ADA Wrist Blade Handle Screw	---	---	\$1.30
	X-4900011C	ADA Wrist Blade Handle Index-Cold	---	---	\$0.80
	X-4900011H	ADA Wrist Blade Handle Index-Hot	---	---	\$0.80
	X-4500001	Spout Sleeve	Polished Chrome	---	\$11.95
	X-4900013	Spout Snap Ring	---	---	\$1.30
	X-4900012	Spout O-ring	---	---	\$1.30
	X-4900084	1.5 GPM Aerator	Polished Chrome	---	\$9.40
X-4900085	1.0 GPM Aerator	Polished Chrome	---	\$10.15	
X-4900086	0.5 GPM Aerator	Polished Chrome	---	\$14.00	

\*Special Order. Allow 10-12 weeks delivery  
Low flow aerators available upon request.

Pioneer faucets feature aerators that meet ANSI/ASME A112.18.1 flow requirements of 1.5 GPM

# LEGACY // Lavatory Faucets

## SINGLE HANDLE LAVATORY FAUCETS

		Model#	Description	Finish	Case	Price
		<b>3LG160</b>	Single Handle Lavatory Faucet Metal Lever Handle	Polished Chrome	12	\$136.00
		<b>3LG160-BN</b>	4-5/8" Reach, 1-7/8" from Deck to Aerator Ceramic Disc Cartridge with Temperature Limit Stop 3-Hole 4" Installation Brass Pop-Up Drain Assembly With 1.2 GPM Flow Rate	PVD Brushed Nickel	12	\$148.00
		<b>3LG160B</b>	Builder Tract Pack	Polished Chrome	12	\$134.00
		<b>3LG160B-BN</b>		PVD Brushed Nickel	12	\$146.00
		<b>3LG160H</b>	18" SS Flex Connectors with 3/8" Compression Connection Nuts	Polished Chrome	12	\$138.00
		<b>3LG160H-BN</b>		PVD Brushed Nickel	12	\$150.00
		<b>3LG161</b>	Single Handle Lavatory Faucet Metal Lever Handle 4-5/8" Reach, 1-7/8" from Deck to Aerator Ceramic Disc Cartridge with Temperature Limit Stop 3-Hole 4" Installation With 1.2 GPM Flow Rate	Polished Chrome	12	\$109.00
		<b>3LG161G</b>	Single Handle Lavatory Faucet Metal Lever Handle 4-5/8" Reach, 1-7/8" from Deck to Aerator Ceramic Disc Cartridge with Temperature Limit Stop 3-Hole 4" Installation Brass Grid Strainer Drain Assembly With 1.2 GPM Flow Rate	Polished Chrome	12	\$130.00

Builder Tract Packs sold in case quantities only.  
Low flow aerators available upon request.  
\*Special Order. Allow 10-12 weeks delivery.

Pioneer faucets feature aerators that meet ANSI/ASME A112.18.1 flow requirements of 1.5 GPM

# LEGACY // Lavatory Faucets

## SINGLE HANDLE LAVATORY FAUCETS

























	Model#	Description	Finish	Case	Price
<b>PARTS</b>	X-1300001	Lever Handle	Polished Chrome	---	\$22.35
	X-1300002	Loop Handle	Polished Chrome	---	\$22.35
	X-1300003	Acrylic Ball Handle	---	---	\$7.65
	X-4900017	Retainer Cap	Polished Chrome	---	\$11.95
	X-4900018	Retainer Nut	---	---	\$4.10
	X-3900003	Ceramic Disc Cartridge	---	---	\$12.95
	X-4300003	Base Plate	---	---	\$1.80
	X-5300001	Mounting Kit	---	---	\$2.80
	X-4900004	Supply Nut	---	---	\$3.30
	X-6300001	Brass Pop-Up	Polished Chrome	---	\$40.00
	X-6300002	Brass Grid Strainer	Polished Chrome	---	\$51.00
	X-4900001	Hot & Cold Indicator	---	---	\$1.05
	X-4900002	Allen Screw	---	---	\$1.30
	X-4300004	Index Button	---	---	\$2.30
	X-4300005	Screw	---	---	\$0.80
	X-4900081	1.5 GPM Aerator	Polished Chrome	---	\$8.90
	X-4900082	1.0 GPM Aerator	Polished Chrome	---	\$9.40
	X-4900083	0.5 GPM Aerator	Polished Chrome	---	\$13.20

Low flow aerators available upon request.

Pioneer faucets feature aerators that meet ANSI/ASME A112.18.1 flow requirements of 1.5 GPM

# LEGACY // Lavatory Faucets

## SINGLE HANDLE LAVATORY FAUCETS

		Model#	Description	Finish	Case	Price
	   	3LG260H	Single Handle Lavatory Faucet Metal Lever Handle	Polished Chrome	12	\$159.00
		3LG260H-BN	4-3/8" Reach, 2-3/8" from Deck to Aerator Ceramic Disc Cartridge with Temperature Limit Stop 1-Hole Installation Brass Pop-Up Drain Assembly Easy-Install 18" Flex Supply Lines With 3/8" Connections With 1.2 GPM Flow Rate	PVD Brushed Nickel	12	\$170.00
		3LG260BH	Builder Tract Pack	Polished Chrome	12	\$157.00
		3LG260BH-BN		PVD Brushed Nickel	12	\$168.00
	   	3LG260H-WD	1 or 3-Hole 4" Installation Deck Cover Plate Included	Polished Chrome	12	\$166.00
		3LG260H-WD-BN		PVD Brushed Nickel	12	\$182.60
		3LG260H-WD-MZ		Moroccan Bronze	12	\$199.00
		3LG262BH	50/50 Pop-up Drain Assembly Builder Tract Pack	Polished Chrome	12	\$143.00
	   	3LG264H	Single Handle Lavatory Faucet Metal Lever Handle	Polished Chrome	12	\$130.00
		3LG264H-BN	4-3/8" Reach, 2-3/8" from Deck to Aerator Ceramic Disc Cartridge with Temperature Limit Stop 1-Hole Installation Easy-Install 18" Flex Supply Lines With 3/8" Connections With 1.2 GPM Flow Rate	PVD Brushed Nickel	12	\$143.00
	   	3LG264H-WD	1 or 3-Hole 4" Installation Deck Cover Plate Included	Polished Chrome	12	\$140.00
		3LG264H-WD-BN		PVD Brushed Nickel	12	\$154.00
	   	3LG264GH	Single Handle Lavatory Faucet Metal Lever Handle 4-3/8" Reach, 2-3/8" from Deck to Aerator Ceramic Disc Cartridge with Temperature Limit Stop 1-Hole Installation Brass Grid Strainer Drain Assembly Easy-Install 18" Flex Supply Lines With 3/8" Connections With 1.2 GPM Flow Rate	Polished Chrome	12	\$153.00
		3LG264GH-WD	1 or 3-Hole 4" Installation Deck Cover Plate Included	Polished Chrome	12	\$163.00

Builder Tract Packs sold in case quantities only.  
Low flow aerators available upon request.  
\*Special Order. Allow 10-12 weeks delivery.

Pioneer faucets feature aerators that meet ANSI/ASME A112.18.1 flow requirements of 1.5 GPM

LEGACY

# LEGACY // Lavatory Faucets

## SINGLE HANDLE LAVATORY FAUCETS











	Model#	Description	Finish	Case	Price
<b>PARTS</b>	X-1300001	Lever Handle	Polished Chrome	---	\$22.35
	X-1300002	Loop Handle	Polished Chrome	---	\$22.35
	X-4900017	Retainer Cap	Polished Chrome	---	\$11.95
	X-4900018	Retainer Nut	---	---	\$4.10
	X-3900003	Ceramic Disc Cartridge	---	---	\$12.95
	X-4300024	Hole Cover	Polished Chrome	---	\$1.30
	X-5300007	Mounting Kit	---	---	\$6.60
	X-6300001	Brass Pop-Up	Polished Chrome	---	\$40.00
	X-6300002	Brass Grid Strainer	Polished Chrome	---	\$51.00
	X-4300038	Deck Cover Plate	Polished Chrome	---	\$16.75
	X-4900001	Hot & Cold Indicator	---	---	\$1.05
	X-4900002	Allen Screw	---	---	\$1.30
	X-4900081	1.5 GPM Aerator	Polished Chrome	---	\$8.90
	X-4900082	1.0 GPM Aerator	Polished Chrome	---	\$9.40
	X-4900083	0.5 GPM Aerator	Polished Chrome	---	\$13.20

Low flow aerators available upon request.

Pioneer faucets feature aerators that meet ANSI/ASME A112.18.1 flow requirements of 1.5 GPM

# LEGACY // Lavatory Faucets

## TWO HANDLE LAVATORY FAUCETS

	Model#	Description	Finish	Case	Price
	 <b>3LG110</b>	Two Handle Lavatory Faucet Mini Blade Handles 3-9/16" Reach, 1-15/16" from Deck to Aerator Ceramic Disc Cartridges 3-Hole 4" Installation Brass Pop-Up Drain Assembly With 1.2 GPM Flow Rate	Polished Chrome	12	\$116.00
	 <b>3LG111</b>	Two Handle Lavatory Faucet Mini Blade Handles 3-9/16" Reach, 1-15/16" from Deck to Aerator Ceramic Disc Cartridges 3-Hole 4" Installation With 1.2 GPM Flow Rate	Polished Chrome	12	\$88.00
	 <b>3LG121</b>	Two Handle Lavatory Faucet ADA Wrist Blade Handles 3-9/16" Reach, 1-15/16" from Deck to Aerator Ceramic Disc Cartridges 3-Hole 4" Installation With 1.2 GPM Flow Rate	Polished Chrome	12	\$96.00
	 <b>3LG121G</b>	Two Handle Lavatory Faucet ADA Wrist Blade Handles 3-9/16" Reach, 1-15/16" from Deck to Aerator Ceramic Disc Cartridges 3-Hole 4" Installation Brass Grid Strainer Drain Assembly With 1.2 GPM Flow Rate	Polished Chrome	12	\$119.00
	 <b>3LG130</b>	Two Handle Lavatory Faucet Metal Lever Handles 3-9/16" Reach, 1-15/16" from Deck to Aerator Ceramic Disc Cartridges 3-Hole 4" Installation Brass Pop-Up Drain Assembly With 1.2 GPM Flow Rate	Polished Chrome	12	\$123.00
	 <b>3LG130-BN</b>		PVD Brushed Nickel	12	\$127.00

Builder Tract Packs sold in case quantities only.  
Low flow aerators available upon request.  
\*Special Order. Allow 10-12 weeks delivery.

Pioneer faucets feature aerators that meet ANSI/ASME A112.18.1 flow requirements of 1.5 GPM

LEGACY

# LEGACY // Lavatory Faucets

## TWO HANDLE LAVATORY FAUCETS

	Model#	Description	Finish	Case	Price
<b>PARTS</b>	X-190001C	Acrylic Handle-Cold	---	---	\$5.35
	X-190001H	Acrylic Handle-Hot	---	---	\$5.35
	X-190002C	Mini Blade Handle-Cold	Polished Chrome	---	\$10.95
	X-190002H	Mini Blade Handle-Hot	Polished Chrome	---	\$10.95
	X-190003C	Wrist Blade Handle-Cold	Polished Chrome	---	\$18.30
	X-190003H	Wrist Blade Handle-Hot	Polished Chrome	---	\$18.30
	X-190004C	Lever Handle-Cold	Polished Chrome	---	\$19.55
	X-190004H	Lever Handle-Hot	Polished Chrome	---	\$19.55
	X-4900007	Bonnet Nut	---	---	\$1.80
	X-390002C	Ceramic Stem-Cold	---	---	\$10.70
	X-390002H	Ceramic Stem-Hot	---	---	\$10.70
	X-4900008	Mounting Kit	---	---	\$1.30
	X-4900004	Supply Nut	---	---	\$3.30
	X-6300001	Brass Pop-Up	Polished Chrome	---	\$40.00
	X-6300002	Brass Grid Strainer	Polished Chrome	---	\$51.00
	X-4900005C	Acrylic Handle Index-Cold	---	---	\$1.30
	X-4900005H	Acrylic Handle Index-Hot	---	---	\$1.30
	X-4900006	Handle Screw	---	---	\$1.30
	X-4900009C	Mini Blade Handle Index-Cold	---	---	\$1.30
	X-4900009H	Mini Blade Handle Index-Hot	---	---	\$1.30
	X-4900066	Mini Blade Handle Screw	---	---	\$1.30
	X-4900010	ADA Wrist Blade Handle Screw	---	---	\$1.30
	X-4900011C	ADA Wrist Blade Handle Index-Cold	---	---	\$0.80
	X-4900011H	ADA Wrist Blade Handle Index-Hot	---	---	\$0.80
	X-4900014C	Lever Handle Index-Cold, Hot	Polished Chrome	---	\$2.30
	X-4900014H	Lever Handle Index-Cold, Hot	Polished Chrome	---	\$2.30
	X-4900015	Lever Handle Screw	---	---	\$1.30
	X-4300058	1.5 GPM Aerator	Polished Chrome	---	\$8.90
	X-4300059	1.0 GPM Aerator	Polished Chrome	---	\$9.40
	X-4300047	0.5 GPM Aerator	Polished Chrome	---	\$13.45

Builder Tract Packs sold in case quantities only.

Low flow aerators available upon request.









\*Special Order. Allow 10-12 weeks delivery

Pioneer faucets feature aerators that meet ANSI/ASME A112.18.1 flow requirements of 1.5 GPM

# LEGACY // Tub & Shower

## NEW FAUCETS

### TUB & SHOWER TRIM SETS

	Model#	Description	Finish	Case	Price
	  	<b>4LG100T</b> Single Handle Tub and Shower Trim Set Metal Lever Handle	Polished Chrome	12	\$173.00
	<b>4LG100T-BN</b>	Ceramic Disc Cartridge with Temperature Limit Stop	PVD Brushed Nickel	12	\$193.00
	<b>4LG100T-MZ</b>	Four Function 3-3/8" Diameter Showerhead Shower Arm and Flange Combo 1/2" IPS/Slip-On Diverter Tub Spout Color Match Sleeve and Retaining Ring With 1.75 GPM Flow Rate  For Use with 4020B Valve - Valve not included	Moroccan Bronze	12	\$205.00
		<b>4LG100T-ADA</b> Single Handle Tub and Shower Trim Set with Diverter and Handheld Showerhead Four Function 3-3/8" Diameter Showerhead-1.75 GPM Shower Arm and Flange Metal Lever Handles Color Match Sleeve and Retaining Ring Ceramic Disc Cartridge with Temperature Limit Cap Three Way Diverter Valve Trim For Use with 4020B and 4100B Valves - Valves not included Combo 1/2" IPS/Slip-On Diverter Tub Spout w/ Escutcheon  Five Functions Handheld Showerhead w/ Non-Positive Shut Off-1.5 GPM 24" Slide Bar with Brass Mounts 60" Stainless Steel Flex Hose Brass Drop Ell with Vacuum Breaker	Polished Chrome	---	\$416.50
		<b>4LG300T-ADA</b>	Less Tub Spout	Polished Chrome	---
		<b>4LG400T-ADA</b> Single Handle Valve Trim Set with Handheld Showerhead Metal Lever Handle Color Match Sleeve and Retaining Ring Ceramic Disc Cartridge with Temperature Limit Cap For Use with 4020B Valve - Valve not included  Five Functions Handheld Showerhead W/Non-Positive Shut Off-1.5 GPM 24" Slide Bar with Brass Mounts 60" Stainless Steel Flex Hose Brass Drop Ell with Vacuum Breaker	Polished Chrome	---	\$343.00

Pioneer showerheads meet ANSI/ASME A112.18.1 flow requirements of maximum 1.75 GPM

# LEGACY // Tub & Shower





## TUB & SHOWER TRIM SETS

	Model#	Description	Finish	Case	Price
<b>PARTS</b>	X-1400025	Lever Handle	Polished Chrome	---	\$19.30
	X-3400007	Ceramic Cartridge W/ Temperature Limit Stop	---	---	\$49.00
	X-4200001	Retainer Cap	Polished Chrome	---	\$7.40
	X-4400030	Sleeve	Polished Chrome	---	\$23.35
	X-4400062	Face Plate Screws	Polished Chrome	---	\$4.85
	X-4400080	Lock Nut	---	---	\$4.35
	X-4600025	Rubber Gasket	---	---	\$2.30
	X-4600035	Sleeve	Polished Chrome	---	\$26.40
	X-4600036	Adapter	---	---	\$1.30
	X-4900024	Allen Wrench	---	---	\$1.30
	X-4900080	Allen Screw	---	---	\$1.30
	X-6400079	1.75 GPM Showerhead Four Function Showerhead	Polished Chrome	---	\$35.00
	X-6400002	Shower Arm	Polished Chrome	---	\$13.20
	X-6400003	Legacy Shower Arm Flange	Polished Chrome	---	\$10.95
	X-6400058	Legacy Face Plate	Polished Chrome	---	\$45.00

Pioneer showerheads meet ANSI/ASME A112.18.1 flow requirements of maximum 1.75 GPM

# PREMIUM // Kitchen Faucets

## TWO HANDLE WALL MOUNT FAUCETS

	Model#	Description	Finish	Case	Price
	 2PM440	Two Handle Wall Mount Faucet Metal Cross Handles Hi-Tubular Spout 9-1/4" Reach Ceramic Disc Cartridges 2-Hole 3-1/2" to 8-1/2" Installation 1/2" Eccentric Connections With 1.5 GPM Flow Rate	Polished Chrome	12	\$170.00
	 2PM540	Two Handle Wall Mount Faucet Metal Cross Handles Tubular Spout 10-1/2" Reach Ceramic Disc Cartridges 2-Hole 3-1/2" to 8-1/2" Installation 1/2" Eccentric Connections With 1.5 GPM Flow Rate	Polished Chrome	12	\$170.00
<b>PARTS</b>	X-120005C	Cross Handle-Cold	Polished Chrome	---	\$15.00
	X-120005H	Cross Handle-Hot	Polished Chrome	---	\$15.00
	X-4200054	Handle Bonnet Nut	Polished Chrome	---	\$8.15
	X-3200003	Ceramic Stem	---	---	\$14.00
	X-4200056	Eccentric Elbow	Polished Chrome	---	\$27.45
	X-4200057	Flange	Polished Chrome	---	\$9.15
	X-2200008	High Spout	Polished Chrome	---	\$45.00
	X-2200009	Tubular Spout	Polished Chrome	---	\$44.00
	X-4200055C	Index Button-Cold	---	---	\$3.30
	X-4200055H	Index Button-Hot	---	---	\$3.30
	X-4900029	Cross Handle Screw	---	---	\$1.30
	X-4900030	Eccentric Elbow Washer	---	---	\$1.80
	X-4200053	Spout Bonnet Nut	Polished Chrome	---	\$5.60
	X-4200090	Spout Snap Ring	---	---	\$1.30
	X-4900012	Tubular Spout O-Ring	---	---	\$1.30
	X-4900084	1.5 GPM Aerator	Polished Chrome	---	\$9.40
	X-4900085	1.0 GPM Aerator	Polished Chrome	---	\$10.15
X-4900086	0.5 GPM Aerator	Polished Chrome	---	\$14.00	





Low flow aerators available upon request.

Pioneer faucets feature aerators that meet ANSI/ASME A112.18.1 flow requirements of 1.5 GPM

PREMIUM

# PREMIUM // Bar Faucets



## SINGLE HANDLE BAR FAUCETS

	Model#	Description	Finish	Case	Price
 	  <b>5PM330</b>	Single Handle Bar Faucet Metal Lever Handle Rigid Gooseneck Spout 5-1/4" Reach, 5-1/4" from Deck to Aerator Stainless Steel Ball Operation 2-Hole 4" to 12" Installation SS Flex Connectors With 1.5 GPM Flow Rate	Polished Chrome	6	\$193.00
<b>PARTS</b>	<b>X-1200004</b>	Lever Handle	Polished Chrome	---	\$16.75
	<b>X-2500003</b>	Gooseneck Rigid Spout	Polished Chrome	---	\$99.00
	<b>X-3200002</b>	SS Ball	---	---	\$3.30
	<b>X-4200032</b>	Spout Washer	---	---	\$4.35
	<b>X-4200044</b>	Hose	---	---	\$9.15
	<b>X-4200045</b>	Retainer Cap & Adjusting Ring	Polished Chrome	---	\$6.35
	<b>X-4200046</b>	Cam & Washer	---	---	\$2.30
	<b>X-4200048</b>	Base & Gasket	Polished Chrome	---	\$13.45
	<b>X-4200050</b>	Handle Hole Cover	---	---	\$1.30
	<b>X-4200051</b>	Handle Allen Screw	---	---	\$1.30
	<b>X-4900004</b>	Supply Nut	---	---	\$3.30
	<b>X-4900019</b>	Springs & Seats	---	---	\$1.30
	<b>X-5200003</b>	Spout Mounting Kit	---	---	\$3.30
	<b>X-5200008</b>	Mounting Tool	---	---	\$5.35
	<b>X-5200009</b>	Valve Mounting Kit	---	---	\$2.80
	<b>X-4900084</b>	1.5 GPM Aerator	Polished Chrome	---	\$9.40

Pioneer faucets feature aerators that meet ANSI/ASME A112.18.1 flow requirements of 1.5 GPM

# DEL MAR // Kitchen Faucets

## TWO HANDLE KITCHEN FAUCETS

	Model#	Description	Finish	Case	Price
	2DM201	Two Handle Kitchen Widespread Faucet Metal Lever Handles	Polished Chrome	6	\$314.00
	2DM201-BN	Gooseneck Spout Swivel 360° 8-1/16" Reach, 6-11/16" from Deck to Aerator	PVD Brushed Nickel	6	\$340.00
	2DM201-ORB	Ceramic Disc Cartridges 3 or 4-Hole 6" to 16" Installation Side Spray Assembly With 1.5 GPM Flow Rate	Oil Rubbed Bronze	6	\$354.00
	2DM300	Two Handle Kitchen Faucet Metal Lever Handles Gooseneck Spout Swivel 360° 8-1/16" Reach, 7-1/8" from Deck to Aerator Ceramic Disc Cartridges 3-Hole 8" Installation With 1.5 GPM Flow Rate	Polished Chrome	6	\$170.00
	2DM301	Two Handle Kitchen Faucet Metal Lever Handles	Polished Chrome	6	\$203.00
	2DM301-BN	Gooseneck Spout Swivel 360° 8-1/16" Reach, 7-1/8" from Deck to Aerator	PVD Brushed Nickel	6	\$219.00
	2DM301-MZ*	Ceramic Disc Cartridges 4-Hole 8" Installation Side Spray Assembly With 1.5 GPM Flow Rate	Moroccan Bronze	6	\$232.00

Low flow aerators available upon request.  
\*Special Order. Allow 10-12 weeks delivery.

Pioneer faucets feature aerators that meet ANSI/ASME A112.18.1 flow requirements of 1.5 GPM

DEL MAR

# DEL MAR // Kitchen Faucets



## TWO HANDLE KITCHEN FAUCETS

	Model#	Description	Finish	Case	Price
<b>PARTS</b>	X-1200006	Lever Handle	Polished Chrome	---	\$22.35
	X-2200004	High Gooseneck Spout Set	Polished Chrome	---	\$102.00
	X-2200005	High Gooseneck Spout Set	Polished Chrome	---	\$147.00
	X-3900002C	Ceramic Stem - Cold	---	---	\$10.70
	X-3900002H	Ceramic Stem - Hot	---	---	\$10.70
	X-4200016	Diverter Piston	---	---	\$8.09
	X-4200018	Side Spray Assembly	Polished Chrome	---	\$31.50
	X-4200020	Gooseneck Spout Sleeve	Polished Chrome	---	\$39.00
	X-4200021	Gooseneck Spout Deck Plate	Polished Chrome	---	\$28.45
	X-4200022	Gooseneck Spout Deck Plate Mounting Gasket	---	---	\$2.30
	X-4200023	Gooseneck Spout Escutcheon	Polished Chrome	---	\$17.55
	X-4200025	Cross Connector	---	---	\$35.00
	X-4200049	Cap And Washer	---	---	\$2.30
	X-4900002	3/32" Allen Screw	---	---	\$1.30
	X-4900004	Supply Nut	---	---	\$3.30
	X-4900007	Bonnet Nut	---	---	\$1.80
	X-4900008	Mounting Kit	---	---	\$1.30
	X-4900012	Tubular Spout O-Ring	---	---	\$1.30
	X-4900013	Tubular Spout Snap Ring	---	---	\$1.30
	X-4900022	Bonnet Nut	---	---	\$4.35
	X-4900023	Handle Escutcheon	Polished Chrome	---	\$18.30
	X-4900024	3/32" Allen Wrench	---	---	\$1.30
	X-5200003	Spout Mounting Kit	---	---	\$3.30
	X-5900001	Valve Mounting Kit	---	---	\$7.15
	X-4200114	Female 55/64" Thread Aerator-1.5 GPM	Polished Chrome	---	\$10.70

Pioneer faucets feature aerators that meet ANSI/ASME A112.18.1 flow requirements of 1.5 GPM

# DEL MAR // Bar Faucets

## TWO HANDLE BAR FAUCETS

		Model#	Description	Finish	Case	Price
		5DM100	Two Handle Bar Faucet Metal Lever Handles	Polished Chrome	12	\$119.00
		5DM100-BN	Gooseneck Spout Swivel 360° 5-3/16" Reach, 5-7/8" from Deck to Aerator	PVD Brushed Nickel	12	\$131.00
		5DM100-ORB	Ceramic Disc Cartridges 2 or 3-Hole 4" Installation With 1.5 GPM Flow Rate	Oil Rubbed Bronze	12	\$136.00
<b>PARTS</b>		X-1900005	Lever Handle	Polished Chrome	---	\$22.35
		X-4900007	Bonnet Nut	---	---	\$1.80
		X-3900002C	Ceramic Stem - Cold	---	---	\$10.70
		X-3900002H	Ceramic Stem - Hot	---	---	\$10.70
		X-4500002	Deck Plate	Polished Chrome	---	\$14.50
		X-4500003	Deck Plate Mounting Gasket	---	---	\$1.80
		X-4900008	Mounting Kit	---	---	\$1.30
		X-4900004	Supply Nut	---	---	\$3.30
		X-2500001	5-3/16" Reach Gooseneck Spout	Polished Chrome	---	\$45.00
		X-4900002	Allen Screw	---	---	\$1.30
		X-4500001	Spout Sleeve Set	Polished Chrome	---	\$11.95
		X-4900013	Tubular Spout Snap Ring	---	---	\$1.30
		X-4900012	Tubular Spout O-ring	---	---	\$1.30
		X-4900084	1.5 GPM Aerator	Polished Chrome	---	\$9.40

Pioneer faucets feature aerators that meet ANSI/ASME A112.18.1 flow requirements of 1.5 GPM

DEL MAR

# DEL MAR // Lavatory Faucets

## TWO HANDLE LAVATORY FAUCETS



	Model#	Description	Finish	Case	Price
	3DM100	Two Handle Lavatory Faucet Metal Lever Handles	Polished Chrome	6	\$177.00
	3DM100-BN	6-1/16" Reach, 2-1/8" from Deck to Aerator Ceramic Disc Cartridges 3-Hole 4" Installation Brass Pop-Up Drain Assembly With 1.2 GPM Flow Rate	PVD Brushed Nickel	6	\$191.70
<b>PARTS</b>	X-1900005	Lever Handle	Polished Chrome	---	\$22.35
	X-4900037	Bonnet Nut	---	---	\$1.95
	X-3900002C	Ceramic Stem - Cold	---	---	\$10.70
	X-3900002H	Ceramic Stem - Hot	---	---	\$10.70
	X-4300006	Base Plate	---	---	\$2.30
	X-4900008	Mounting Kit	---	---	\$1.30
	X-4900004	Supply Nut	---	---	\$3.30
	X-6300003	Brass Pop-Up Drain Assembly	Polished Chrome	---	\$36.00
	X-4900002	3/32" Allen Screw	---	---	\$1.30
	X-4300008	Pop-Up Lift Rod	Polished Chrome	---	\$12.95
	X-4300061	1.0 GPM Aerator	Polished Chrome	---	\$14.00
	X-4300062	0.5 GPM Aerator	Polished Chrome	---	\$18.55

Low flow aerators available upon request.

Pioneer faucets feature aerators that meet ANSI/ASME A112.18.1 flow requirements of 1.5 GPM

# DEL MAR // Lavatory Faucets

## TWO HANDLE LAVATORY FAUCETS



	Model#	Description	Finish	Case	Price
	3DM200	Two Handle Lavatory Widespread Faucet Metal Lever Handles	Polished Chrome	6	\$301.00
	3DM200-BN	Rigid C Style Spout 5-7/8" Reach, 2-1/8" from Deck to Aerator Ceramic Disc Cartridges 3-Hole 6" to 16" Installation Brass Pop-Up Drain Assembly With 1.2 GPM Flow Rate	PVD Brushed Nickel	6	\$322.00
	3DM300	Two Handle Lavatory Widespread Faucet Metal Lever Handles	Polished Chrome	6	\$294.00
	3DM300-ORB	Rigid J Style Spout 4-5/8" Reach, 4" from Deck to Aerator Ceramic Disc Cartridges 3-Hole 6" to 16" Installation Brass Pop-Up Drain Assembly With 1.2 GPM Flow Rate	Oil Rubbed Bronze	6	\$339.00
<b>PARTS</b>	X-1200006*	Lever Handle	Polished Chrome	---	\$22.35
	X-2300001*	'C' Spout	Polished Chrome	---	\$154.00
	X-2300002*	'J' Spout	Polished Chrome	---	\$142.00
	X-3900002C	Ceramic Stem - Cold	---	---	\$10.70
	X-3900002H	Ceramic Stem - Hot	---	---	\$10.70
	X-4300010*	C Spout Escutcheon	Polished Chrome	---	\$17.55
	X-4300011	'Y' Connector	---	---	\$16.00
	X-4300041	Pop-Up Lift Rod	Polished Chrome	---	\$14.50
	X-4900002	3/32" Allen Screw	---	---	\$1.30
	X-4900004	Supply Nut	---	---	\$3.30
	X-4900020	'Y' Connector & Washer	---	---	\$21.35
	X-4900022	Bonnet Nut	---	---	\$4.35
	X-4900023	Handle Escutcheon	Polished Chrome	---	\$18.30
	X-4900024	3/32" Allen Wrench	---	---	\$1.30
	X-5300003	J Spout Mounting Kit	---	---	\$2.80
	X-5900001	Valve Mounting Kit	---	---	\$7.15
	X-6300012*	Brass Pop-Up Drain Assembly	Polished Chrome	---	\$41.00
	X-4300063	1.5 GPM Aerator	Polished Chrome	---	\$12.45
	X-4300064	1.0 GPM Aerator	Polished Chrome	---	\$14.50
	X-4300065	0.5 GPM Aerator	Polished Chrome	---	\$20.60
	X-4900081	1.5 GPM Aerator	Polished Chrome	---	\$8.90
	X-4900082*	1.0 GPM Aerator	Polished Chrome	---	\$9.40
	X-4900083	0.5 GPM Aerator	Polished Chrome	---	\$13.20

Low flow aerators available upon request.  
\*Special Order. Allow 10-12 weeks delivery

Pioneer aerators meet ANSI/ASME A112.18.1 flow requirements of maximum 1.5 GPM

# DEL MAR // Tub & Shower

## TUB & SHOWER TRIM SETS

	Model#	Description	Finish	Case	Price
	4DM100T	Single Handle Tub and Shower Trim Set Metal Lever Handle	Polished Chrome	12	\$200.00
	4DM100T-BN	Ceramic Disc Cartridge with Temperature Limit Stop Single Function 3-3/8" Standard Showerhead Shower Arm and Flange Combo 1/2" IPS/Slip-On Diverter Tub Spout Tub Spout Escutcheon Color Match Sleeve and Retaining Ring With 1.75 GPM Flow Rate  For Use with 4020B Valve - Valve not included	PVD Brushed Nickel	12	\$222.00
	4DM300T	Single Handle Shower Trim Set Metal Lever Handle	Polished Chrome	12	\$180.00
	4DM300T-BN	Ceramic Disc Cartridge with Temperature Limit Stop Single Function 3-3/8" Standard Showerhead Shower Arm and Flange Color Match Sleeve and Retaining Ring With 1.75 GPM Flow Rate  For Use with 4020B Valve - Valve not included	PVD Brushed Nickel	12	\$200.00
	4DM300T-ORB		Oil Rubbed Bronze	12	\$213.00

Low flow showerheads available upon request.

Pioneer showerheads meet ANSI/ASME A112.18.1 flow requirements of maximum 1.75 GPM

# DEL MAR // Tub & Shower

## TUB & SHOWER TRIM SETS

	Model#	Description	Finish	Case	Price
<b>PARTS</b>	X-6400015	Shower Arm Flange	Polished Chrome	---	\$4.85
	X-6400002	Shower Arm	---	---	\$13.20
	X-6400019	Single Function Standard Showerhead	Polished Chrome	---	\$30.45
	X-3400007	Ceramic Disc Cartridge	Polished Chrome	---	\$49.00
	X-4400030*	Sleeve	Polished Chrome	---	\$23.35
	X-4400080	Lock Nut	---	---	\$4.35
	X-4200001	Retainer Cap	---	---	\$7.40
	X-6400059	Face plate	---	---	\$40.00
	X-1400026	Lever Handle	Polished Chrome	---	\$30.45
	X-4900024	3/32" Allen Wrench	Polished Chrome	---	\$1.30
	X-4400002	Spout Escutcheon	Polished Chrome	---	\$10.95
	X-6400021	Combo 1/2" IPS/Slip-On Diverter Tub Spout	Polished Chrome	---	\$39.00
	X-4900080	Allen Screw	---	---	\$1.30
	X-4400062*	Face Plate Screws	Polished Chrome	---	\$4.85

# DEL MAR // Tub & Shower

## HANDHELD SHOWER SETS

	Model#	Description	Finish	Case	Price
	<b>6DM400</b>	Handheld Shower Set	Polished Chrome	6	\$245.00
	<b>6DM400-BN</b>	25-1/8" Slide Bar with Brass Mount Five Function Handheld Showerhead	PVD Brushed Nickel	6	\$265.00
	<b>6DM400-ORB</b>	Brass Drop Ell With Vacuum Breaker 60" Stainless Steel Flex Hose With 1.75 GPM Flow Rate	Oil Rubbed Bronze	6	\$276.00
<b>PARTS</b>	<b>X-4600048</b>	1.75 GPM Five Function Handheld Shower	Polished Chrome	---	\$106.03
	<b>X-4600006</b>	60" Stainless Steel Flex Hose	Polished Chrome	---	\$120.00
	<b>X-4600005</b>	Vacuum Breaker	Polished Chrome	---	\$14.50
	<b>X-4600004</b>	Drop Ell	Polished Chrome	---	\$45.00
	<b>X-5600001</b>	Mounting Kit	---	---	\$1.30
	<b>X-4600001</b>	Handheld Shower Slide Bar Brass Mount	Polished Chrome	---	\$31.50
	<b>X-4600003</b>	Slide Bar	Polished Chrome	---	\$99.00
	<b>X-4900024</b>	3/32" Allen Wrench	---	---	\$1.30
	<b>X-4600002</b>	Mounting Screw	---	---	\$1.30
	<b>X-4900002</b>	3/32" Allen Screw	---	---	\$1.30

Low flow showerheads available upon request.

Pioneer showerheads meet ANSI/ASME A112.18.1 flow requirements of maximum 1.75 GPM

# DEL MAR // Tub & Shower





## TWO HANDLE ROMAN TUB TRIM SETS

	Model#	Description	Finish	Case	Price
	4DM610T	Two Handle Roman Tub Trim Set Metal Lever Handles	Polished Chrome	6	\$227.00
	4DM610T-BN	Rigid C Style Spout 7-1/2" Reach 3-Hole 8" to 16" Installation  For Use with 4300B Valve - Valve not included	PVD Brushed Nickel	6	\$245.00
<b>PARTS</b>	X-1400002	Lever Handle	Polished Chrome	---	\$29.45
	X-4400014	Handle Escutcheon	Polished Chrome	---	\$35.00
	X-4900024	3/32" Allen Wrench	---	---	\$1.30
	X-2400003	'C' Spout	Polished Chrome	---	\$202.00
	X-4900002	3/32" Allen Screw	---	---	\$1.30
	X-4900026	1/8" Allen Wrench	---	---	\$0.80
	X-4400017	Spout Hole Cover	Polished Chrome	---	\$1.30
	X-4400018	1/8" Allen Screw	---	---	\$0.80
	X-4400016	Flow Streamer	Polished Chrome	---	\$7.40
	X-4400015	"C" Spout Escutcheon	Polished Chrome	---	\$41.00



DEL MAR

# AMERICANA // Kitchen Faucets

## TWO HANDLE KITCHEN FAUCETS

	Model#	Description	Finish	Case	Price
	2AM400	Two Handle Kitchen Faucet Metal Lever Handles	Polished Chrome	6	\$376.00
	2AM400-BN	Spout Swivel 360°	PVD Brushed Nickel	6	\$408.40
	2AM400-ORB	8-11/16" Reach, 10-1/4" from Deck to Aerator Ceramic Disc Cartridges 1-Hole Installation Easy-Install 30" Flex Supply Lines With 3/8" Connections With 1.5 GPM Flow Rate	Oil Rubbed Bronze	6	\$427.00
	2AM401	Two Handle Kitchen Faucet Metal Lever Handles	Polished Chrome	6	\$490.00
	2AM401-BN	Spout Swivel 360°	PVD Brushed Nickel	6	\$534.40
	2AM401-ORB	8-11/16" Reach, 10-1/4" from Deck to Aerator Ceramic Disc Cartridges 2- Hole Installation Side Spray Assembly Easy-Install 30" Flex Supply Lines With 3/8" Connections With 1.5 GPM Flow Rate	Oil Rubbed Bronze	6	\$563.00
	2AM500	Two Handle Kitchen Bridge Faucet Metal Lever Handles	Polished Chrome	6	\$386.00
	2AM500-BN	Spout Swivel 360°	PVD Brushed Nickel	6	\$407.00
	2AM500-ORB	8-11/16" Reach, 9-7/16" from Deck to Aerator Ceramic Disc Cartridges 3-Hole 8" Installation With 1.5 GPM Flow Rate	Oil Rubbed Bronze	6	\$444.00
	2AM501	Two Handle Kitchen Bridge Faucet Metal Lever Handles	Polished Chrome	6	\$500.00
	2AM501-BN	Spout Swivel 360°	PVD Brushed Nickel	6	\$532.00
	2AM501-SS*	8-11/16" Reach, 9-7/16" from Deck to Aerator Ceramic Disc Cartridges	PVD Stainless Steel	6	\$532.00
	2AM501-ORB	4-Hole 8" Installation Side Spray Assembly	Oil Rubbed Bronze	6	\$573.00
	2AM501-MZ	With 1.5 GPM Flow Rate	Moroccan Bronze	6	\$573.00

## TWO HANDLE POT FILLERS

	Model#	Description	Finish	Case	Price
	2AM600	Wall Mount Pot Filler Metal Lever Handles	Polished Chrome	6	\$364.70
	2AM600-BN	Space Saving Swivel Spout (Folds in When Not in Use)	PVD Brushed Nickel	6	\$381.10
	2AM600-SS*	21-7/8" Spout Reach	PVD Stainless Steel	6	\$381.10
	2AM600-ORB	Ceramic Disc Cartridges 1-Hole Wall Mount Installation	Oil Rubbed Bronze	6	\$396.00
	2AM600-MZ	Designed for Cold Water 1/2" IPS Connection with Flange	Moroccan Bronze	6	\$396.00
	2AM700	Deck Mount Pot Filler Metal Lever Handles	Polished Chrome	6	\$459.00
	2AM700-BN	Space Saving Swivel Spout (Folds in When Not in Use)	PVD Brushed Nickel	6	\$490.00
	2AM700-SS*	19-3/8" Reach 15-1/4" From Deck to Aerator	PVD Stainless Steel	6	\$490.00
	2AM700-ORB	Ceramic Disc Cartridges 1-Hole Deck Mount Installation Designed for Cold Water 3/8" Compression SS Flex Connector Line	Oil Rubbed Bronze	6	\$527.00

Low flow aerators available upon request.  
\*Special Order. Allow 10-12 weeks delivery.

Pioneer faucets feature aerators that meet ANSI/ASME A112.18.1 flow requirements of 1.5 GPM

# AMERICANA // Kitchen Faucets



## TWO HANDLE KITCHEN FAUCETS & POT FILLERS

	Model#	Description	Finish	Case	Price
<b>PARTS</b>	X-1200007C	Handle Set-Cold	Polished Chrome	---	\$48.00
	X-1200007H	Handle Set-Hot	Polished Chrome	---	\$48.00
	X-1200008C	Handle Set-Cold	Polished Chrome	---	\$51.00
	X-1200008H	Handle Set-Hot	Polished Chrome	---	\$51.00
	X-1200009	Handle Set	Polished Chrome	---	\$55.00
	X-1200010	Secondary Handle Set	Polished Chrome	---	\$27.45
	X-2200012	Spout Set	Polished Chrome	---	\$165.00
	X-2200013	Spout Set	Polished Chrome	---	\$167.00
	X-3200004C	Ceramic Stem-Cold	---	---	\$24.40
	X-3200004H	Ceramic Stem-Hot	---	---	\$24.40
	X-4200016	Diverter Piston	---	---	\$8.09
	X-4200059	Side Spray	Polished Chrome	---	\$121.00
	X-4900041	Aerator-2.0 GPM-Male	Polished Chrome	---	\$4.85
	X-4900089	Aerator-1.5 GPM-Male	Polished Chrome	---	\$6.60
	X-4900072	Aerator-1.0 GPM-Male	Polished Chrome	---	\$7.65
	X-4900073	Aerator-0.5 GPM-Male	Polished Chrome	---	\$14.75
	X-4900091	Aerator-1.5 GPM-Female	Polished Chrome	---	\$12.95
	X-4900092	Aerator-1.0 GPM-Female	Polished Chrome	---	\$9.90
	X-4900093	Aerator-0.5 GPM-Female	Polished Chrome	---	\$17.55

AMERICANA

# AMERICANA // Lavatory Faucets

## TWO HANDLE LAVATORY FAUCETS

		Model#	Description	Finish	Case	Price
		3AM400	Two Handle Lavatory Widespread Faucet Metal Lever Handles	Polished Chrome	6	\$381.00
		3AM400-BN	Rigid Spout	PVD Brushed Nickel	6	\$407.00
		3AM400-ORB	6-11/16" Reach, 5" from Deck to Aerator Ceramic Disc Cartridges	Oil Rubbed Bronze	6	\$438.00
		3AM400-MZ	3-Hole 6" to 16" Installation Brass Pop-Up Drain Assembly With 1.5 GPM Flow Rate	Moroccan Bronze	6	\$438.00
<b>PARTS</b>	X-1300004C	Lever Handle-Cold	Polished Chrome	---	\$45.00	
	X-1300004H	Lever Handle-Hot	Polished Chrome	---	\$45.00	
	X-4900037	Bonnet Nut	---	---	\$1.95	
	X-4900038	Bonnet Nut Gasket	---	---	\$1.30	
	X-3900004C	Ceramic Stem-Cold	---	---	\$11.60	
	X-3900004H	Ceramic Stem-Hot	---	---	\$11.60	
	X-4300018	Deck Plate Mounting Gasket	---	---	\$1.30	
	X-4900008	Mounting Kit	---	---	\$1.30	
	X-4900004	Supply Nut	---	---	\$3.30	
	X-6300005	Brass Pop-Up Drain Assembly	Polished Chrome	---	\$49.00	
	X-4900042C	Handle Button-Cold	Polished Chrome	---	\$2.30	
	X-4900042H	Handle Button-Hot	Polished Chrome	---	\$2.30	
	X-4900036	Handle Screw	---	---	\$1.30	
	X-4900091	Female 55/64" Thread Aerator-1.5 GPM	Polished Chrome	---	\$12.95	
	X-1900007C	Lever Handle-Cold	Polished Chrome	---	\$47.00	
	X-1900007H	Lever Handle-Hot	Polished Chrome	---	\$47.00	
	X-4900034	Handle Escutcheon	Polished Chrome	---	\$15.75	
	X-5900001	Valve Mounting Kit	---	---	\$7.15	
	X-4900022	Bonnet Nut	---	---	\$4.35	
	X-4300015	Cross Connector	---	---	\$11.45	
	X-5300005	Spout Locknut Set	---	---	\$2.30	
	X-2300003	Spout Set	Polished Chrome	---	\$172.00	
	X-6300020	Brass Pop-Up Drain Assembly	Polished Chrome	---	\$54.00	
	X-4900035	Handle Screw	Polished Chrome	---	\$1.30	
	X-4900032	Spout Escutcheon	Polished Chrome	---	\$11.95	

Low flow aerators available upon request.  
\*Special Order. Allow 10-12 weeks delivery.

Pioneer faucets feature aerators that meet ANSI/ASME A112.18.1 flow requirements of 1.5 GPM

# AMERICANA // Tub & Shower

## TUB & SHOWER TRIM SETS

	Model#	Description	Finish	Case	Price
	4AM100T	Single Handle Tub and Shower Trim Set Metal Lever Handle	Polished Chrome	6	\$386.00
	4AM100T-BN	Ceramic Disc Cartridge with Temperature Limit Stop Single Function 3-1/2" Diameter Showerhead	PVD Brushed Nickel	6	\$404.70
	4AM100T-ORB	13" Long Shower Arm and Flange Combo 1/2" IPS/Slip-On Diverter Tub Spout Tub Spout Escutcheon Color Match Sleeve and Retaining Ring With 1.75 GPM Flow Rate  For Use with 4020B Valve - Valve not included	Oil Rubbed Bronze	6	\$445.80
	X-4400065	Spout Escutcheon	Polished Chrome	---	\$27.45
	X-6400004	Showerhead	Polished Chrome	---	\$123.00
	X-6400005	Shower Arm	Polished Chrome	---	\$56.00
	X-6400006	Shower Arm Flange	Polished Chrome	---	\$21.35
	X-6400007	Face Plate	Polished Chrome	---	\$47.00
	X-6400008	Combo 1/2" IPS/Slip-On Diverter Tub Spout	Polished Chrome	---	\$40.00
	X-6400022	Combo 1/2" IPS/Slip On Tub Spout	Polished Chrome	---	\$28.45
X-6400097	Showerhead-1.75 GPM	Polished Chrome	---	\$130.71	
X-1400029	Handle Set	Polished Chrome	---	\$87.00	





Low flow showerheads available upon request.

Pioneer showerheads meet ANSI/ASME A112.18.1 flow requirements of maximum 1.75 GPM

AMERICANA

# BRENTWOOD // Lavatory Faucets

## TWO HANDLE LAVATORY FAUCETS

	Model#	Description	Finish	Case	Price
	3BR400	Two Handle Lavatory Widespread Faucet Metal Lever Handles	Polished Chrome	6	\$276.00
	3BR400-BN	Rigid J Style Spout	PVD Brushed Nickel	6	\$292.00
	3BR400-ORB	4-9/16" Reach, 4-1/2" from Deck to Aerator Ceramic Disc Cartridges 3-Hole 6" to 16" Installation Brass Pop-Up Drain Assembly Includes Spout and Valve Escutcheons With 1.2 GPM Flow Rate	Oil Rubbed Bronze	6	\$318.00
	3BR410	Two Handle Lavatory Widespread Faucet Porcelain Lever Handles	Polished Chrome	6	\$276.00
	3BR410-BN	Rigid J Style Spout 4-9/16" Reach, 4-1/2" from Deck to Aerator Ceramic Disc Cartridges 3-Hole 6" to 16" Installation Brass Pop-Up Drain Assembly Includes Spout and Valve Escutcheons With 1.2 GPM Flow Rate	PVD Brushed Nickel	6	\$292.00
	3BR300	Two Handle Lavatory Faucet Metal Lever Handles	Polished Chrome	6	\$142.00
	3BR300-BN	Gooseneck Spout Swivel 360°	PVD Brushed Nickel	6	\$157.00
	3BR300-ORB*	4-7/8" Reach, 4-9/16" from Deck to Aerator Ceramic Disc Cartridges 3-Hole 4" Installation Brass Pop-Up Drain Assembly With 1.2 GPM Flow Rate	Oil Rubbed Bronze	6	\$166.00
	3BR310	Two Handle Lavatory Faucet Porcelain Lever Handles	Polished Chrome	6	\$142.00
	3BR310-BN	Gooseneck Spout Swivel 360° 4-7/8" Reach, 4-9/16" from Deck to Aerator Ceramic Disc Cartridges 3-Hole 4" Installation Brass Pop-Up Drain Assembly With 1.2 GPM Flow Rate	PVD Brushed Nickel	6	\$157.00

Low flow aerators available upon request.  
\*Special Order. Allow 10-12 weeks delivery.

Pioneer faucets feature aerators that meet ANSI/ASME A112.18.1 flow requirements of 1.5 GPM

# BRENTWOOD // Lavatory Faucets

## TWO HANDLE LAVATORY FAUCETS

	Model#	Description	Finish	Case	Price
<b>PARTS</b>	X-1900009C	Lever Handle-Cold	Polished Chrome	---	\$29.45
	X-1900009H	Lever Handle-Hot	Polished Chrome	---	\$29.45
	X-1900010C	Porcelain Lever Handle-Cold	Polished Chrome	---	\$18.30
	X-1900010H	Porcelain Lever Handle-Hot	Polished Chrome	---	\$18.30
	X-1900011C	Porcelain Cross Handle-Cold	Polished Chrome	---	\$16.25
	X-1900011H	Porcelain Cross Handle-Hot	Polished Chrome	---	\$16.25
	X-1900012C	Beaux Lever Handle-Cold	Polished Chrome	---	\$21.35
	X-1900012H	Beaux Lever Handle-Hot	Polished Chrome	---	\$21.35
	X-2300008	11" Spout Set	Polished Chrome	---	\$137.00
	X-2300009	C Spout Set	Polished Chrome	---	\$132.00
	X-3300002C	Ceramic Stem-Cold	---	---	\$13.20
	X-3300002H	Ceramic Stem-Hot	---	---	\$13.20
	X-3900002C	Ceramic Stem-Cold	---	---	\$10.70
	X-3900002H	Ceramic Stem-Hot	---	---	\$10.70
	X-6300008	Brass Pop-Up	Polished Chrome	---	\$41.00
	X-4900081	Aerator-1.5 GPM-Male	Polished Chrome	---	\$8.90
	X-4900082	Aerator-1.0 GPM-Male	Polished Chrome	---	\$9.40
	X-4900083	Aerator-0.5 GPM-Male	Polished Chrome	---	\$13.20
	X-4900091	Aerator-1.5 GPM-Female	Polished Chrome	---	\$12.95
	X-4900092	Aerator-1.0 GPM-Female	Polished Chrome	---	\$9.90
	X-4900093	Aerator-0.5 GPM-Female	Polished Chrome	---	\$17.55
	X-4900095	Aerator-1.5 GPM-Female	Polished Chrome	---	\$12.20
	X-4900096	Aerator-1.0 GPM-Female	Polished Chrome	---	\$9.15
	X-4900097	Aerator-0.5 GPM-Female	Polished Chrome	---	\$16.25

Low flow aerators available upon request.

Pioneer faucets feature aerators that meet ANSI/ASME A112.18.1 flow requirements of 1.5 GPM

# PIONEER // Accessories

## SHOWERHEADS







	Model#	Description	Finish	Case	Price
	X-6400079	Four Function Showerhead Rub-Clean Anti-Scale Spray	Polished Chrome	---	\$35.00
	X-6400079-BN	Brass Ball Swivel Joint 3-3/8" Diameter With 1.75 GPM Flow Rate	PVD Brushed Nickel	---	\$45.00
	X-6400045	Four Function Showerhead Rub-Clean Anti-Scale Spray	Polished Chrome	---	\$44.00
	X-6400045-BN	Brass Ball Swivel Joint 3-3/8" Face With 1.5 GPM Flow Rate	PVD Brushed Nickel	---	\$46.00
	X-6400081	Single Function Standard Showerhead Rub-Clean Anti-Scale Spray	Polished Chrome	---	\$25.40
	X-6400081-BN	Brass Ball Swivel Joint 3-3/8" Diameter With 1.75 GPM Flow Rate	PVD Brushed Nickel	---	\$39.00
	X-6400052	Single Function Standard Showerhead Rub-Clean Anti-Scale Spray	Polished Chrome	---	\$32.50
	X-6400052-BN	Brass Ball Swivel Joint 3-3/8" Diameter With 1.5 GPM Flow Rate	PVD Brushed Nickel	---	\$39.00
	X-6400083	Single Function Rain Showerhead Rub-Clean Anti-Scale Spray	Polished Chrome	---	\$65.00
	X-6400083-BN	Offset Brass Ball Swivel Joint 6" Diameter With 1.75 GPM Flow Rate	PVD Brushed Nickel	---	\$56.00
	X-6400055	Single Function Rain Showerhead Rub-Clean Anti-Scale Spray	Polished Chrome	---	\$55.00
	X-6400055-BN	Offset Brass Ball Swivel Joint 6" Diameter With 1.5 GPM Flow Rate	PVD Brushed Nickel	---	\$58.00
	X-6400036	Dual Function Showerhead Brass Ball Swivel Joint Side Spray Adjustment 3-1/2" Diameter With 2.5 GPM Flow Rate	Polished Chrome	---	\$102.00
	X-6400014	Dual Function Showerhead Brass Ball Swivel Joint Side Spray Adjustment 2-1/2" Diameter With 2.5 GPM Flow Rate	Polished Chrome	---	\$52.00

Low flow showerheads available upon request.

Pioneer showerheads meet ANSI/ASME A112.18.1 flow requirements of maximum 1.75 GPM

# PIONEER // Accessories

## SHOWERHEADS

	Model#	Description	Finish	Case	Price
	X-6400077	Single Function 6" Square Rain Showerhead Rub-Clean Anti-Scale Spray Brass Ball Swivel Joint	Polished Chrome	---	\$121.00
	X-6400078*	*With 1.5 GPM Flow Rate	Polished Chrome	---	\$121.00
	X-6400012	Single Function Rain Showerhead Rub-Clean Anti-Scale Spray Brass Ball Swivel Joint 8" Diameter With 2.5 GPM Flow Rate	Polished Chrome	---	\$202.00
	X-6400013	15" L Shape Shower Arm And Shower Arm Flange	Polished Chrome	---	\$64.00
	X-6400038	Single Function Rain Showerhead Rub-Clean Anti-Scale Spray Brass Ball Swivel Joint 8" Diameter 15" L Shape Shower Arm And Shower Arm Flange With 2.5 GPM Flow Rate	Polished Chrome	---	\$266.00
	X-6400095	Five Function Showerhead Rub-Clean Anti-Scale Spray Brass Ball Swivel Joint 3" Diameter With 1.75 GPM Flow Rate	Polished Chrome	---	\$60.00
	X-6400097	Single Function Showerhead Rub-Clean Anti-Scale Spray Brass Ball Swivel Joint 3-1/2" Diameter With 1.75 GPM Flow Rate	Polished Chrome	---	\$124.65









Low flow showerheads available upon request.

Pioneer showerheads meet ANSI/ASME A112.18.1 flow requirements of maximum 1.75 GPM

ACCESSORIES

# PIONEER // Accessories





## DRAINS - WASTE & OVERFLOW

	Model#	Description	Finish	Case	Price
	X-6400029	Bath Waste & Overflow-Tip-Toe Bath Strainer; 1-1/2" Coarse Thread	Polished Chrome	---	\$24.40
	X-6400029-BN		PVD Brushed Nickel	---	\$25.40
	X-6400029-ORB		Oil Rubbed Bronze	---	\$27.45
	X-6400030	Bath Waste & Overflow-Lift & Lock Strainer; 1-1/2" Coarse Thread	Polished Chrome	---	\$20.30
	X-6400030-BN		PVD Brushed Nickel	---	\$21.35
	X-6400030-ORB		Oil Rubbed Bronze	---	\$24.40
	X-6400031	Bath Waste & Overflow-Trip Lever Face Plate With Screws	Polished Chrome	---	\$16.00
	X-6400031-BN		PVD Brushed Nickel	---	\$16.75
	X-6400031-ORB		Oil Rubbed Bronze	---	\$19.30
	X-6400032	Bath Waste & Overflow-2-Hole Face Plate With Screws	Polished Chrome	---	\$10.70
	X-6400032-BN		PVD Brushed Nickel	---	\$11.95
	X-6400032-ORB		Oil Rubbed Bronze	---	\$13.45
	X-6400033	Bath Waste & Overflow-1-Hole Face Plate With Screw	Polished Chrome	---	\$9.90
	X-6400033-BN		PVD Brushed Nickel	---	\$10.70
	X-6400033-ORB		Oil Rubbed Bronze	---	\$11.20
	X-6400034	Bath Waste & Overflow-Grid Strainer With Screw	Polished Chrome	---	\$8.40
	X-6400034-BN		PVD Brushed Nickel	---	\$9.15
	X-6400034-ORB		Oil Rubbed Bronze	---	\$9.90
	X-6300010	Push Down Drain Without Overflow	Polished Chrome	---	\$65.00
	X-6300011	Push Down Drain With Overflow	Polished Chrome	---	\$65.00

Special order finishes available upon request. Allow 10-12 weeks delivery.

# PIONEER // Valves





## PRESSURE BALANCE TUB & SHOWER VALVES

	Model#	Description	Finish	Case	Price
	4020B	Single Handle Pressure Balance Tub and Shower Valve Set Combo CXC and IPS Inlet and Outlet Connections Cartridge, Sleeve, Locknut and Retaining Ring Ship with Trim Kit Brass Inlet Stops Back to Back Installation	---	12	\$68.00
	4020B-B*	Builder Tract Pack	---	12	\$66.00
	4020B-D	Single Handle Tub and Shower with Diverter Valve Set Combo CXC and IPS Inlet and Outlet Connections Cartridge, Sleeve, Locknut and Retaining Ring Ship with Trim Kit Brass Inlet Stops Back to Back Installation Includes Three-Way Diverter Valve	---	6	\$151.00
	4021B	Single Handle Pressure Balance Tub and Shower Valve Set 1/2" PEX Inlet & Shower Outlet W/Combo CXC & IPS Tub Outlet Cartridge, Sleeve, Locknut, Retaining Ring Ship with Trim Kit Brass Inlet Stops Back to Back Installation	---	12	\$88.00
	4021B-B*	Builder Tract Pack	---	12	\$86.00
	4022B	Single Handle Pressure Balance Tub and Shower Valve Set 1/2" PEX Inlet & Shower Outlet W/Combo CXC & IPS Tub Outlet Cartridge, Sleeve, Locknut, Retaining Ring Ship with Trim Kit Brass Inlet Stops Back to Back Installation	---	12	\$88.00
	4022B-B*	Builder Tract Pack	---	12	\$86.00
	4023B	Single Handle Pressure Balance Tub and Shower Valve Set 1/2" CPVC Inlet W/Combo CXC & IPS Outlet Cartridge, Sleeve, Locknut, Retaining Ring Ship with Trim Kit Brass Inlet Stops Back to Back Installation	---	12	\$88.00
	4023B-B*	Builder Tract Pack	---	12	\$86.00

\*Builder Tract Packs sold in case quantities only.

# PIONEER // Valves



## PRESSURE BALANCE TUB & SHOWER VALVES

	Model#	Description	Finish	Case	Price
	4024B	Single Handle Pressure Balance Tub and Shower Valve Set 1/2" PEX Inlet & Shower Outlet W/Copper Stub Tub Outlet Cartridge, Sleeve, Locknut, Retaining Ring Ships With Trim Kit Brass Inlet Stops Back to Back Installation	---	6	\$96.00
	4024B-B*	Builder Tract Pack	---	6	\$93.00
	4025B	Single Handle Pressure Balance Tub and Shower Valve Set 1/2" PEX Inlet W/Combo CXC & IPS Outlet Cartridge, Sleeve, Locknut, Retaining Ring Ships With Trim Kit Brass Inlet Stops Back to Back Installation	---	12	\$82.00
	4025B-B*	Builder Tract Pack	---	12	\$80.00
	4027B	Single Handle Pressure Balance Tub and Shower Valve Set 1/2" Uponor PEX Inlet W/Combo CXC & IPS Outlet Cartridge, Sleeve, Lock nut, Retaing Ring Ships With Trim Kit Brass Inlet Stops Back to Back Installation	---	12	\$85.00
	4027B-B*	Builder Tract Pack	---	12	\$83.00
	4100B	Single Handle Diverter Valve Set Combo CXC and IPS Connections Three Way Diverter Valve Ceramic Disc Cartridge	---	12	\$83.00

\*Builder Tract Packs sold in case quantities only.

# PIONEER // Valves

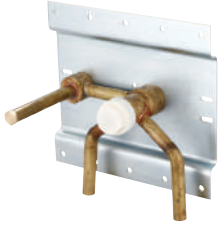

## ROMAN TUB AND VESSEL FILLER VALVES

	Model#	Description	Finish	Case	Price
	4200B	Single Handle Lavatory Wall Mount Vessel Filler Valve Set 1/2" CXC Connections Cartridge, Sleeve, Lock nut, Retaing Ring Ships With Trim Kit 2-Hole 4" Installation With Mounting Plate	---	6	\$133.90
	4210B	Two Handle Lavatory Wall Mount Vessel Filler Valve Set 1/2" CXC Connections Cartridges, Sleeves Ships With Trim Kit 3-Hole 8" Installation With Mounting Plate	---	6	\$148.50
	4300B	Two Handle Roman Tub Valve Set 1/2" IPS Connections Quick Mount Connector Deck or Ledge Mount Ceramic Disc Cartridges 3-Hole 8" to 16" Installation Brass Plug 12" SS Flex Hose, Mud Guards Included	---	12	\$146.00

\*Builder Tract Packs sold in case quantities only.

# PIONEER // Ceramic Disc Cartridges

## CERAMIC DISC CARTRIDGES

	Model#	Where Used	Price	
	X-3200001	<b>Kitchen</b>	\$16.00	
		<b>Tub &amp; Shower</b>		
		2BL220		4MT710
		2CL250		4MT711
		2GB250		4MT720
	2LG220			
	2MT250			
	X-3400002	<b>Tub &amp; Shower</b>	\$12.70	
		990512		
	X-3400003	<b>Valves</b>	\$21.10	
		1910B		

## CERAMIC DISC CARTRIDGES





	Model#	Where Used	Price		
	X-3400007	<b>Kitchen</b>	\$49.00		
		<b>Tub &amp; Shower</b>			
		<b>Tub &amp; Shower</b>			
		4AM100T		4BR330T	4LG100T
		4AM200T		4CB100T	4LG300T
		4AM300T		4CB200T	4MT100T
		4AM400T		4CB300T	4MT110T
		4BL100T		4CB400T	4MT120T
		4BL200T		4CL100T	4MT200T
		4BL300T		4CL200T	4MT300T
		4BL400T		4CL300T	4MT320T
		4BR100T		4CS100T	4MT400T
		4BR110T		4CS200T	4PR100T
		4BR120T		4CS300T	4PR110T
		4BR130T		4DM100T	4PR300T
		4BR200T		4DM200T	4PR310T
		4BR210T		4DM300T	4PR400T
		4BR220T		4DM400T	<b>Valves</b>
		4BR230T		4GB100T	4020B
		4BR300T		4GB110T	
		4BR310T		4GB300T	
		4BR320T		4GB310T	

## REPLACEMENT PARTS KIT

	Model#	Description	Price
	X-4900117	Genuine Pioneer Product's Repair Parts	\$399.00

# PIONEER // Ceramic Disc Cartridges

## CERAMIC DISC CARTRIDGES

Model#		Where Used		Price	Model#		Where Used			Price	
	X-3600001	Valves		\$22.35		X-3900003	Kitchen	Lavatory	Lavatory	\$12.95	
		199731B						2MT170H	3LG160		3LG181
							2MT171H	3LG161	3MT180		
								3LG170	3MT181		
								3LG171	3MT181G		
								3LG180			
	X-3600003	Tub & Shower	Valves	\$19.97		X-3900001	Kitchen	Kitchen	Lavatory	\$13.20	
		6AM101T	4020B-D					2LG160	2MT340		3MT160
		6CB101T	4100B					2LG160H	2MT341		3MT161
		6CS101T						2LG161	2PM160		3MT161G
		6DM101T						2LG161H	2PM161		3MT166
		6GB101T						2LG162	2VL160		3MT168
		6LG101T						2LG170	2VL161		3MT170
		6PR101T						2LG171	2VL260		3MT171
		4020B-D						2LG250	2VL261		3MT171G
		4100B						2LG260	Tub & Shower		3MT176
								2LG261			3MT178
					2MT160H	4MT840	3MT800				
					2MT161H	4MT840	3PM160				
					2MT330		Valves				
					2MT331		4200B				

CARTRIDGES

# PIONEER // Ceramic Stems & Washerless Cartridges



## CERAMIC STEM

	Model#	Where Used	Price
	X-3200003	Kitchen	\$14.00
		2PM440	
		2PM540	

## WASHERLESS CARTRIDGE

	Model#	Where Used	Price
	X-3400001	Valves	\$9.40
		4010B	
		4011B	

## CERAMIC STEM - COLD, HOT

	Model#	Where Used	Price
	X-3200004C X-3200004H	Kitchen	\$24.40
		2AM400	
		2AM401	
		2AM500	
		2AM501	
	X-3900004C X-3900004H	Kitchen	\$11.60
		2AM100	
		2AM101	
		2AM200	
		2AM201	

## DIVERTER PISTON

	Model#	Where Used	Price		
	X-3900002C X-3900002H	Kitchen	\$10.70		
		2BR100		5DM100	3LG111
		2BR101		5LG120	3LG121
		2BR110		5LG220	3LG121G
		2BR111		Lavatory	3LG130
		2BR120		3BL100	3MT100
		2BR121		3BL200	3MT110
		2BR130		3BR100	3MT400
		2BR131		3BR110	3MT500
		2BR200		3BR120	3PR200
		2BR201		3BR130	Tub & Shower
		2BR210		3BR200	
		2BR211		3BR210	4AM610
		2BR220		3BR220	4AM611
		2BR221		3BR230	4BR600
		2BR230		3BR300	4BR610
		2BR231		3BR310	4BR620
		2CB200		3BR320	4BR630
		2CB201		3BR330	4BR700
		2DM100		3BR400	4BR710
		2DM101		3BR410	4BR720
		2DM200		3BR420	4BR730
		2DM201		3BR430	4BR800
		2DM300		3BR500	4BR810
		2DM301		3BR510	4BR820
		2LG100		3BR520	4BR830
		2LG101		3BR530	4GB611
		2LG110		3CB100	4MT610
		2LG111		3CB101	4MT611
		2LG120		3CB200	4MT620
2LG230	3DM100	Valves			
2LG231	3DM101	4300B			
2LG240	3DM200				
2MT200	3DM300				
2MT201	3GB100				
2MT210	3GB200				
2MT211	3LG100				
2PR200	3LG101				
2PR201	3LG110				

# PIONEER // Diverter Pistons, Pressure Balance, Spools & Associated Cartridge Parts

## CERAMIC STEM

	Model#	Where Used		Price
	X-3200002	Kitchen	Bar	
		2PM330	5PM330	\$3.30
		2PM331		

## CAM & PACKING

	Model#	Where Used		Price
	X-4200046	Kitchen	Bar	
		2PM330	5PM330	\$2.30
		2PM331		

## SPRINGS & SEATS

	Model#	Where Used		Price
	X-4900019	Kitchen	Bar	
		2PM330	5PM330	\$1.30
		2PM331	Valve	
			4010B	
			4011B	

## DIVERTER PISTON

	Model#	Where Used		Price
	X-4200007	Kitchen		
		2LG161	2LG261	\$2.30
		2LG161H	2MT161H	
		2LG162	2PM161	
		2LG171	2PM331	

## DIVERTER PISTON

	Model#	Where Used			Price
	X-4200016	Kitchen	Kitchen	Kitchen	
		2AM101	2BR231	2MT171H	\$8.09
		2AM201	2CB201	2MT201	
		2AM401	2CL331	2MT211	
		2AM501	2CS201	2MT331	
		2BR101	2CS331	2MT341	
		2BR111	2DM101	2PR201	
		2BR121	2DM201		
		2BR131	2DM301		
		2BR201	2LG101		
		2BR211	2LG111		
		2BR221	2LG231		

## PRESSURE BALANCE SPOOL

	Model#	Where Used			Price
	X-4400005	Valves			
		4010B	1910B		\$44.00
		4011B			

## PRESSURE BALANCE SPOOL

	Model#	Where Used			Price
	X-4400070	Kitchen			
		990512			\$36.00

MISC. PARTS

# PIONEER // Extensions & Adapters

EXTENSION LENGTH: 1/2"

Model#	Where Used			Price
X-4200155 	Kitchen	Kitchen	Lavatory	\$7.65
	2AM101	2BR221	2LG231	
	2AM201	2BR231	2MT161H	
	2AM401	2CB201	2MT171H	
	2AM501	2CS201	2MT201	
	2BR101	2CS331	2MT211	
	2BR111	2DM101	2MT331	
	2BR121	2DM201	2MT341	
	2BR131	2DM301	2PR201	
	2BR201	2LG101	2VL161	
	2BR211	2LG111	2VL261	

EXTENSION LENGTH: 1/2"

Model#	Where Used			Price
X-4900105 	Kitchen	Lavatory	Lavatory	\$7.84
	2LG100	3BR110	3GB100	
	2LG101	3BR120	3LG100	
	2LG110	3BR130	3LG101	
	2LG111	3BR200	3LG110	
	2LG120	3BR210	3LG111	
	2LG230	3BR220	3LG121	
	2LG231	3BR230	3LG121G	
	2LG240	3BR300	3LG130	
	<b>Bar</b>	3BR310	3MT100	
	5LG120	3BR320	3MT110	
	5LG220	3BR330	3PR100	
	<b>Lavatory</b>	3CB100		
	3AM100	3CB101		
	3BL100	3DM100		
	3BR100	3DM101		

EXTENSION LENGTH: 1"

Model#	Where Used	Price
X-4400088 	Valves	\$38.00
	4020B	

IPS TO CXC ADAPTER FOR X-6400051

Model#	Where Used	Price
X-5400008 	Tub & Shower	\$3.60
	4MT110T	
	4MT120T	

EXTENSION LENGTH 2"

Model#	Where Used			Price
X-4400089 	Tub & Shower	Kitchen		\$49.00
	4AM610	4BR710	4CL610	
	4AM611	4BR720	4CS610	
	4BR600	4BR730	4MT610	
	4BR610	4BR800	4MT611	
	4BR620	4BR810	<b>Valves</b>	
	4BR630	4BR820	4300B	
	4BR700	4BR830		

IPS TO CXC ADAPTER FOR X-6400024

Model#	Where Used	Price
X-5400009 	Tub & Shower	\$5.10
	4MT100T	
	4MT200T	

EXTENSION LENGTH: 1"

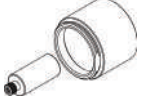
Model#	Where Used	Price
X-4600045 	Valves	\$20.05
	4100B	

MOUNTING TOOL FOR X-5400008 OR X-5400009

Model#	Where Used	Price
X-5400010 	Valves	\$5.85
	4MT100T	
	4MT110T	
	4MT120T	
	4MT200T	

# PIONEER // Extensions & Adapters

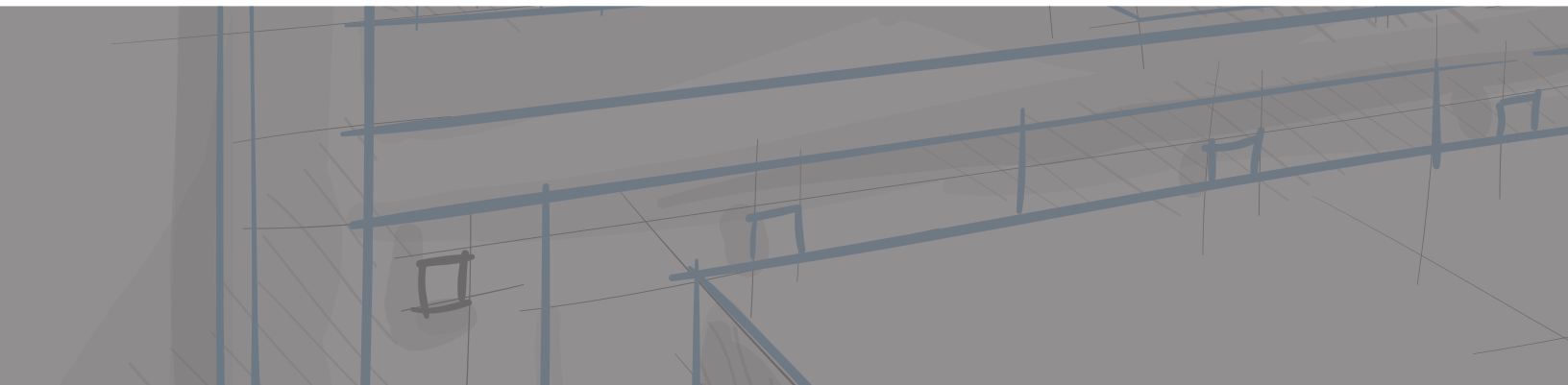



# OLYMPIA //

**2018 OLYMPIA PRODUCT CATALOG PRICE INDEX**

## 2018 OLYMPIA PRODUCT CATALOG PRICE INDEX

MODEL	PAGE	PCS/CS	LIST PRICE	MODEL	PAGE	PCS/CS	LIST PRICE	MODEL	PAGE	PCS/CS	LIST PRICE
ACS-300100	141	50	\$7.50	K-5120	94	12	\$72.00	L-6022-WD-BN	103	12	\$223.50
ACS-300200	141	50	\$10.50	K-5121	94	12	\$82.00	L-6023	103	12	\$165.00
ACS-300400	141	50	\$13.00	K-5130	94	12	\$73.50	L-6050	104	12	\$147.00
ACS-300500	141	50	\$15.50	K-5131	94	12	\$83.50	L-6050B	104	12	\$145.00
ACS-903100	142	96	\$7.50	K-5150	94	12	\$78.00	L-6050B-BN	104	12	\$194.00
ACS-903100-BN	142	96	\$11.00	K-5160	97	12	\$79.00	L-6050-BN	104	12	\$196.00
ACS-903100-ORB	142	96	\$12.50	K-5161	97	12	\$89.00	L-6050-WD	104	12	\$155.00
ACS-903500	142	25	\$24.00	K-5170	97	12	\$84.00	L-6050-WD-BN	104	12	\$206.15
ACS-903500-BN	142	25	\$33.00	K-5171	97	12	\$94.00	L-6051	104	12	\$136.00
B-8150	101	12	\$79.00	K-5270	94	12	\$80.50	L-6051-BN	104	12	\$184.00
B-8150-BN	101	12	\$100.00	K-5271	94	12	\$90.50	L-6051G	104	12	\$151.00
B-8160	101	12	\$74.00	K-5340	97	6	\$88.50	L-6051G-BN	104	12	\$204.00
B-8160-BN	101	12	\$93.50	K-5340-BN	97	6	\$128.00	L-6051G-WD	104	12	\$159.00
B-8170	99	12	\$75.50	K-5342	97	6	\$108.00	L-6051G-WD-BN	104	12	\$211.50
B-8171	99	12	\$63.50	K-5342-BN	97	6	\$152.50	L-6051-WD	104	12	\$146.00
B-8180	99	12	\$82.00	K-5342-ORB	97	6	\$171.00	L-6051-WD-BN	104	12	\$197.00
B-8181	99	12	\$70.00	K-5350	97	6	\$93.00	L-6052	104	12	\$152.00
B-8190	100	12	\$76.50	K-5370	97	6	\$93.50	L-6052B	104	12	\$150.00
B-8191	100	12	\$64.50	K-5370-BN	97	6	\$135.50	L-6052B-BN	104	12	\$200.50
K-4160	92	12	\$76.00	K-5372	98	6	\$113.00	L-6052-BN	104	12	\$202.50
K-4160B	92	12	\$74.00	K-5441	90	6	\$253.50	L-6052-WD	104	12	\$160.00
K-4160B-BN	92	12	\$102.00	K-5441-BN	90	6	\$305.50	L-6052-WD-BN	104	12	\$216.00
K-4160-BN	92	12	\$104.00	L-6010	102	12	\$165.00	L-6160	106	12	\$75.00
K-4160H	92	12	\$86.00	L-6010B	102	12	\$163.00	L-6160B	106	12	\$73.00
K-4160-ORB	92	12	\$116.50	L-6010-BN	102	12	\$219.45	L-6160B-BN	106	12	\$93.00
K-4161	92	12	\$90.50	L-6010-WD	102	12	\$175.00	L-6160-BN	106	12	\$95.00
K-4161B	92	12	\$88.50	L-6010-WD-BN	102	12	\$233.00	L-6160H	106	12	\$76.00
K-4161B-BN	92	12	\$115.00	L-6011	102	12	\$147.00	L-6160H-BN	106	12	\$100.00
K-4161-BN	92	12	\$117.00	L-6011-BN	102	12	\$195.60	L-6160-ORB	106	12	\$106.50
K-4161H	92	12	\$100.50	L-6011-WD	102	12	\$157.00	L-6161	106	12	\$66.00
K-4161H-BN	92	12	\$126.50	L-6011-WD-BN	102	12	\$209.00	L-6161G	106	12	\$81.00
K-4162	92	12	\$100.00	L-6012	102	12	\$170.00	L-6161H	106	12	\$67.00
K-4162B	92	12	\$98.00	L-6012B	102	12	\$168.00	L-6162	106	12	\$80.00
K-4162-BN	92	12	\$129.50	L-6012-BN	102	12	\$226.10	L-6162B	106	12	\$78.00
K-4163	92	12	\$93.00	L-6012-WD	102	12	\$180.00	L-6162-BN	106	12	\$106.50
K-4164	92	12	\$102.50	L-6012-WD-BN	102	12	\$240.00	L-6162H	106	12	\$81.00
K-4170	93	12	\$76.00	L-6013	102	12	\$175.00	L-6164	106	12	\$65.00
K-4170-BN	93	12	\$99.50	L-6020	103	12	\$155.00	L-6170	106	12	\$75.00
K-4171	93	12	\$90.50	L-6020B	103	12	\$153.00	L-6170B	106	12	\$73.00
K-5020	89	6	\$225.00	L-6020-BN	103	12	\$206.15	L-6172	107	12	\$80.00
K-5020-BN	89	6	\$282.50	L-6020-WD	103	12	\$163.00	L-6172-BN	107	12	\$106.50
K-5025	89	6	\$238.00	L-6020-WD-BN	103	12	\$216.80	L-6174	107	12	\$65.00
K-5025-BN	89	6	\$299.00	L-6021	103	12	\$137.00	L-7220	110	12	\$56.50
K-5030	91	6	\$163.00	L-6021-BN	103	12	\$182.25	L-7221	110	12	\$46.50
K-5030-BN	91	6	\$203.50	L-6021-WD	103	12	\$145.00	L-7222	110	12	\$66.50
K-5030-ORB	91	6	\$224.00	L-6021-WD-BN	103	12	\$192.85	L-7240	113	12	\$74.00
K-5040	90	6	\$225.00	L-6022	103	12	\$160.00	L-7240B	113	12	\$72.00
K-5040-BN	90	6	\$281.00	L-6022B	103	12	\$158.00	L-7240B-BN	113	12	\$92.00
K-5040-MZ	90	6	\$330.50	L-6022-BN	103	12	\$212.80	L-7240-BN	113	12	\$94.00
K-5040-ORB	90	6	\$314.50	L-6022-WD	103	12	\$168.00	L-7240-ORB	113	12	\$105.00

## 2018 OLYMPIA PRODUCT CATALOG PRICE INDEX

MODEL	PAGE	PCS/ CS	LIST PRICE	MODEL	PAGE	PCS/ CS	LIST PRICE	MODEL	PAGE	PCS/ CS	LIST PRICE
L-7241	113	12	\$64.00	OP-140005V	129	---	\$5.90	OP-250004	100	---	\$30.10
L-7241-BN	113	12	\$77.50	OP-140006	127	---	\$9.80	OP-250005	100	---	\$27.10
L-7242	113	12	\$82.00	OP-140007	134	---	\$32.20	OP-250007	100	---	\$28.60
L-7242B	113	12	\$80.00	OP-140008	125	---	\$17.90	OP-320001	91	---	\$13.80
L-7242-BN	113	12	\$104.00	OP-140009	131	---	\$10.40	OP-320002	90	---	\$14.80
L-7242-MZ	113	12	\$120.50	OP-140010	125	---	\$10.50	OP-330002C	109	---	\$8.00
L-7242-ORB	113	12	\$114.50	OP-140011	121	---	\$22.00	OP-330002H	109	---	\$8.00
L-7251	111	12	\$62.50	OP-140013C	131	---	\$6.20	OP-340001	129	---	\$15.60
L-7251G	111	12	\$77.50	OP-140013H	131	---	\$6.20	OP-340002	129	---	\$13.80
L-7270	113	12	\$79.00	OP-140013V	131	---	\$6.20	OP-340004C	134	---	\$11.60
L-7270-BN	113	12	\$99.00	OP-140014	125	---	\$16.90	OP-340004H	134	---	\$11.60
L-7271	113	12	\$69.00	OP-140015	125	---	\$21.00	OP-340006C	131	---	\$4.10
L-7272	113	12	\$84.00	OP-140017	134	---	\$33.70	OP-340006H	131	---	\$4.10
L-7272B	113	12	\$82.00	OP-140018	121	---	\$24.00	OP-340007	131	---	\$5.90
L-7272-BN	113	12	\$107.50	OP-140019	121	---	\$26.00	OP-340009	137	---	\$39.30
L-7290	110	12	\$60.00	OP-160001	133	---	\$16.40	OP-360001	133	---	\$14.80
L-7291	110	12	\$50.00	OP-160002	133	---	\$10.50	OP-390001	93	---	\$3.50
L-7292	110	12	\$69.00	OP-160003	121	---	\$21.00	OP-390003	89	---	\$13.00
L-7330	115	6	\$156.00	OP-160004	121	---	\$24.00	OP-390004	95	---	\$4.60
L-7330-BN	115	6	\$199.00	OP-160005	121	---	\$26.00	OP-390005	95	---	\$4.60
L-7330-ORB	115	6	\$223.00	OP-190001	93	---	\$13.30	OP-420001	93	---	\$0.70
L-7332	115	6	\$161.00	OP-190002	93	---	\$13.30	OP-420002	93	---	\$0.70
L-7332-BN	115	6	\$208.00	OP-190003C	95	---	\$3.50	OP-420003	93	---	\$20.40
L-7332-ORB	115	6	\$233.00	OP-190003H	95	---	\$3.50	OP-420004	93	---	\$1.80
L-7372	115	6	\$166.00	OP-190004C	95	---	\$4.10	OP-420005	93	---	\$2.40
L-7372-BN	115	6	\$213.00	OP-190004H	95	---	\$4.10	OP-420006	93	---	\$13.80
L-7372-ORB	115	6	\$238.50	OP-190005C	95	---	\$9.80	OP-420008	91	---	\$5.30
L-7470	108	6	\$205.00	OP-190005H	95	---	\$9.80	OP-420009	91	---	\$7.60
L-7470-BN	108	6	\$240.00	OP-190006C	95	---	\$9.80	OP-420010	91	---	\$0.70
L-7470-ORB	108	6	\$245.00	OP-190006H	95	---	\$9.80	OP-420011	91	---	\$0.70
L-7472	108	6	\$210.00	OP-190008	107	---	\$5.90	OP-420012	91	---	\$22.00
L-7472-BN	108	6	\$245.00	OP-190009C	129	---	\$5.90	OP-420012-BN	91	---	\$28.60
L-7472-ORB	108	6	\$253.00	OP-190009H	129	---	\$5.90	OP-420012-ORB	91	---	\$45.90
L-7570	108	12	\$135.00	OP-190010C	98	---	\$13.30	OP-420013	91	---	\$16.40
L-7570B	108	12	\$133.00	OP-190010H	98	---	\$13.30	OP-420014	90	---	\$9.80
L-7570B-BN	108	12	\$162.70	OP-190013C	129	---	\$9.80	OP-420015	91	---	\$27.60
L-7570-BN	108	12	\$164.70	OP-190013H	129	---	\$9.80	OP-420017	91	---	\$0.70
L-7570-ORB	108	12	\$173.00	OP-190014C	98	---	\$13.30	OP-420018	95	---	\$3.50
L-7572	108	12	\$140.00	OP-190014H	98	---	\$13.30	OP-420019	95	---	\$0.70
L-7572B	108	12	\$138.00	OP-190015C	98	---	\$14.30	OP-420020	95	---	\$0.70
L-7572-BN	108	12	\$170.80	OP-190015H	98	---	\$14.30	OP-420021	95	---	\$4.10
L-7572-ORB	108	12	\$179.40	OP-220001	93	---	\$37.30	OP-420023	142	---	\$8.40
OP-120001	91	---	\$17.40	OP-220002	95	---	\$31.70	OP-420024	90	---	\$5.30
OP-120002	90	---	\$15.90	OP-220003	95	---	\$43.40	OP-420025	95	---	\$12.30
OP-120003	91	---	\$22.00	OP-220004	98	---	\$34.70	OP-420026	95	---	\$1.20
OP-120004	89	---	\$15.00	OP-220005	98	---	\$28.60	OP-420037	93	---	\$19.40
OP-130001	105	---	\$14.00	OP-230001	115	---	\$115.30	OP-420038	90	---	\$21.00
OP-130002	102	---	\$18.00	OP-230005	109	---	\$145.00	OP-420039	90	---	\$31.70
OP-130003	103	---	\$16.00	OP-240007	134	---	\$130.10	OP-420040	90	---	\$38.80
OP-140004V	129	---	\$9.80	OP-250002	101	---	\$30.10	OP-420041	90	---	\$0.90

## 2018 OLYMPIA PRODUCT CATALOG PRICE INDEX

MODEL	PAGE	PCS/ CS	LIST PRICE	MODEL	PAGE	PCS/ CS	LIST PRICE	MODEL	PAGE	PCS/ CS	LIST PRICE
OP-420042	90	---	\$3.20	OP-430029	109	---	\$0.70	OP-460001	133	---	\$3.00
OP-420043	90	---	\$6.40	OP-430032	102	---	\$7.00	OP-460002	133	---	\$13.30
OP-420044	90	---	\$0.70	OP-430033	102	---	\$1.00	OP-460003	133	---	\$24.00
OP-420045	89	---	\$12.60	OP-440007	137	---	\$9.20	OP-460004	133	---	\$5.30
OP-420046	90	---	\$1.10	OP-440008	129	---	\$0.70	OP-460005	133	---	\$9.40
OP-420047	90	---	\$0.70	OP-440009	125	---	\$20.40	OP-460006	133	---	\$32.70
OP-420048	90	---	\$6.40	OP-440010	121	---	\$3.00	OP-460008	133	---	\$22.00
OP-420049	90	---	\$5.30	OP-440011	125	---	\$2.40	OP-460009B	133	---	\$22.00
OP-420050	90	---	\$2.40	OP-440012	129	---	\$4.60	OP-460009T	133	---	\$22.00
OP-420051	93	---	\$23.00	OP-440013	129	---	\$0.70	OP-460010	133	---	\$83.20
OP-420052	93	---	\$23.00	OP-440014	129	---	\$1.70	OP-460011	133	---	\$1.10
OP-420054	89	---	\$24.00	OP-440015	129	---	\$4.10	OP-460013	133	30	\$26.10
OP-420055	89	---	\$10.00	OP-440016	129	---	\$4.60	OP-460019	133	---	\$0.70
OP-420056	89	---	\$0.90	OP-440017	129	---	\$1.10	OP-460020	133	---	\$12.30
OP-420057	89	---	\$3.20	OP-440018	127	---	\$21.00	OP-460021	133	---	\$23.00
OP-420058	89	---	\$6.40	OP-440019	127	---	\$2.40	OP-490001C	100	---	\$1.20
OP-420059	89	---	\$0.70	OP-440020	127	---	\$3.00	OP-490001H	100	---	\$1.20
OP-420060	89	---	\$0.50	OP-440021	137	---	\$3.50	OP-490002	93	---	\$0.70
OP-420061	89	---	\$0.70	OP-440023	137	---	\$0.70	OP-490003	93	---	\$7.00
OP-420062	89	---	\$10.00	OP-440024	137	---	\$1.20	OP-490004	93	---	\$4.60
OP-420063	91	---	\$22.00	OP-440025	134	---	\$18.90	OP-490005	91	---	\$0.70
OP-420064	90	---	\$31.70	OP-440026	134	---	\$11.60	OP-490006	109	---	\$5.30
OP-430001	109	---	\$3.50	OP-440027	134	---	\$5.30	OP-490007	115	---	\$11.40
OP-430005	111	---	\$0.70	OP-440028	134	---	\$0.70	OP-490009	109	---	\$20.40
OP-430006	144	---	\$5.30	OP-440029	134	---	\$0.70	OP-490010	143	---	\$5.70
OP-430007	144	---	\$7.50	OP-440030	134	---	\$21.50	OP-490010-BN	143	---	\$7.00
OP-430007-BN	144	---	\$9.90	OP-440031	134	---	\$27.10	OP-490010-ORB	143	---	\$7.90
OP-430007-ORB	144	---	\$11.10	OP-440033	125	---	\$4.10	OP-490011	109	---	\$0.70
OP-430008	138	---	\$2.50	OP-440034	131	---	\$1.80	OP-490012C	95	---	\$1.20
OP-430009	138	---	\$2.50	OP-440035	131	---	\$3.50	OP-490012H	95	---	\$1.20
OP-430010	107	---	\$1.10	OP-440036	131	---	\$11.60	OP-490013C	95	---	\$1.20
OP-430011	144	---	\$8.80	OP-440037	131	---	\$6.50	OP-490013H	95	---	\$1.20
OP-430011-BN	144	---	\$13.80	OP-440043	121	---	\$1.00	OP-490014	95	---	\$0.70
OP-430011-ORB	144	---	\$14.80	OP-440044	137	---	\$9.90	OP-490015	95	---	\$0.70
OP-430012	144	---	\$10.50	OP-440045	137	38	\$41.90	OP-490016C	96	---	\$0.70
OP-430012-BN	144	---	\$11.60	OP-440051	121	---	\$21.00	OP-490016H	96	---	\$0.70
OP-430012-ORB	144	---	\$12.80	OP-440052	121	---	\$0.70	OP-490017	96	---	\$6.50
OP-430016	138	---	\$4.80	OP-440053	137	---	\$5.00	OP-490018	96	---	\$3.00
OP-430017	138	---	\$4.00	OP-440054	121	---	\$6.00	OP-490019	143	---	\$2.70
OP-430018	138	---	\$4.80	OP-440055	121	---	\$19.00	OP-490021	107	---	\$3.00
OP-430019	138	---	\$1.70	OP-440056	121	---	\$29.00	OP-490022	107	---	\$0.70
OP-430020	138	---	\$1.70	OP-450002	101	---	\$2.40	OP-490023	107	---	\$3.00
OP-430021	102	---	\$6.40	OP-450003	101	---	\$0.70	OP-490025	129	---	\$1.20
OP-430022	105	---	\$3.20	OP-450004	101	---	\$11.00	OP-490026	143	---	\$1.80
OP-430023	103	---	\$1.00	OP-450005	101	---	\$1.80	OP-490027	143	---	\$3.00
OP-430024	105	---	\$5.70	OP-450010	98	---	\$8.70	OP-490028	98	---	\$7.60
OP-430025	103	---	\$0.70	OP-450011	100	---	\$11.00	OP-490029	91	---	\$0.70
OP-430026	103	---	\$16.75	OP-450012	100	---	\$1.20	OP-490030	115	---	\$44.50
OP-430027	109	---	\$11.40	OP-450013	100	---	\$0.70	OP-490035	143	---	\$6.90
OP-430028	109	---	\$0.70	OP-450014	100	---	\$2.40	OP-490035-BN	143	---	\$8.00

## 2018 OLYMPIA PRODUCT CATALOG PRICE INDEX

MODEL	PAGE	PCS/ CS	LIST PRICE	MODEL	PAGE	PCS/ CS	LIST PRICE	MODEL	PAGE	PCS/ CS	LIST PRICE
OP-490035-ORB	143	---	\$9.90	OP-590002	109	---	\$5.90	OP-640029	140	50	\$25.50
OP-490036	127	---	\$0.70	OP-590003	100	---	\$2.40	OP-640029-BN	140	50	\$36.80
OP-490038	96	---	\$0.70	OP-630001	107	50	\$27.60	OP-640029-ORB	140	50	\$39.80
OP-490039	96	---	\$0.70	OP-630002	138	50	\$27.10	OP-640031	140	200	\$11.10
OP-490040	96	---	\$2.40	OP-630002-BN	138	50	\$29.60	OP-640031-BN	140	200	\$16.90
OP-490041	93	---	\$1.20	OP-630002-ORB	138	50	\$30.60	OP-640033	139	25	\$40.80
OP-490042	96	---	\$1.20	OP-630004	138	50	\$22.00	OP-640033-BN	139	25	\$56.70
OP-490043	93	---	\$0.70	OP-630004-BN	138	50	\$24.00	OP-640034	139	25	\$33.70
OP-490044	134	---	\$4.60	OP-630004-ORB	138	50	\$25.00	OP-640034-BN	139	25	\$48.00
OP-490045	142	20	\$98.00	OP-630005	102	---	\$26.00	OP-640035	140	70	\$33.70
OP-490055	143	---	\$8.80	OP-630006	102	---	\$29.00	OP-640035-BN	140	70	\$40.80
OP-490055-BN	143	---	\$9.90	OP-630007	102	---	\$34.00	OP-640035-ORB	140	70	\$43.90
OP-490055-ORB	143	---	\$11.60	OP-640001	121	---	\$1.20	OP-640037	121	---	\$53.00
OP-490056	156	---	\$9.90	OP-640002	121	---	\$11.00	OP-640038	121	48	\$30.00
OP-490056-BN	143	---	\$11.10	OP-640003	140	50	\$15.90	OP-640039	121	48	\$31.00
OP-490056-ORB	143	---	\$12.60	OP-640003-BN	140	50	\$23.00	OP-640040	139	---	\$55.00
OP-490057	143	---	\$8.80	OP-640003-ORB	140	50	\$26.10	OP-640040-BN	139	---	\$69.50
OP-490057-BN	143	---	\$9.90	OP-640005	140	200	\$5.90	OP-640041	121	---	\$49.00
OP-490057-ORB	143	---	\$11.10	OP-640005-BN	140	200	\$11.60	OP-640042	121	---	\$52.00
OP-490058	143	---	\$8.80	OP-640007	121	50	\$20.50	OP-640043	121	---	\$89.00
OP-490058-BN	143	---	\$9.90	OP-640008	121	---	\$9.00	OP-640044	121	---	\$89.00
OP-490058-ORB	143	---	\$11.60	OP-640014	139	50	\$9.90	OP-640045	121	---	\$8.00
OP-490059	96	---	\$8.80	OP-640014-BN	139	50	\$16.40	OP-640046	121	---	\$23.00
OP-490059-BN	143	---	\$9.90	OP-640015	139	50	\$15.70	OP-660002	133	---	\$38.80
OP-490059-ORB	143	---	\$11.60	OP-640015-BN	139	50	\$21.50	OP-660003	133	---	\$34.70
OP-490060	143	---	\$11.10	OP-640016	140	100	\$20.40	OP-660005	133	---	\$43.00
OP-490060-BN	143	---	\$12.10	OP-640016-BN	140	100	\$31.70	P-1131B	134	12	\$110.00
OP-490060-ORB	143	---	\$13.10	OP-640016-ORB	140	100	\$34.70	P-1131T	134	6	\$160.00
OP-490061	143	---	\$11.10	OP-640017	142	60	\$63.80	P-1131T-BN	134	6	\$192.00
OP-490061-BN	143	---	\$12.10	OP-640017-BN	142	60	\$97.60	P-1131T-MZ	134	6	\$226.00
OP-490061-ORB	143	---	\$13.10	OP-640017-ORB	142	60	\$101.50	P-1131T-ORB	134	6	\$215.00
OP-520001	93	---	\$1.80	OP-640018	139	50	\$19.90	P-1210	128	12	\$84.00
OP-520002	93	---	\$2.20	OP-640018-BN	139	50	\$26.00	P-1212	128	12	\$80.50
OP-520003	89	---	\$2.50	OP-640018-ORB	139	50	\$28.20	P-1220	128	12	\$81.50
OP-520004	91	---	\$3.00	OP-640019	139	50	\$13.30	P-1222	128	12	\$78.00
OP-520005	89	---	\$4.20	OP-640019-BN	139	50	\$22.40	P-1230	130	12	\$121.00
OP-520006	91	---	\$11.60	OP-640019-ORB	139	50	\$24.30	P-1230-BN	130	12	\$159.00
OP-520007	91	---	\$4.20	OP-640020	126	---	\$13.00	P-1232	130	12	\$108.00
OP-520008	90	---	\$18.90	OP-640022	140	100	\$21.50	P-1232-BN	130	12	\$136.50
OP-520009	96	---	\$3.40	OP-640022-BN	140	100	\$32.70	P-1250	130	12	\$126.00
OP-520012	89	---	\$5.00	OP-640022-ORB	140	100	\$35.70	P-1250-BN	130	12	\$187.50
OP-530001	107	---	\$3.00	OP-640023	140	70	\$28.60	P-2000	127	12	\$76.00
OP-530003	138	---	\$4.80	OP-640023-BN	140	70	\$35.70	P-2002	127	12	\$72.50
OP-530004	138	---	\$3.30	OP-640023-ORB	140	70	\$38.80	P-2002-BN	127	12	\$115.50
OP-530005	102	---	\$5.00	OP-640024	140	70	\$16.90	P-2240	132	20	\$53.50
OP-540004	134	---	\$8.90	OP-640024-BN	140	70	\$24.00	P-2240-BN	132	20	\$76.00
OP-540005	134	---	\$9.20	OP-640024-ORB	140	70	\$27.60	P-2270	120	12	\$108.00
OP-540006	134	---	\$18.90	OP-640027	140	120	\$21.00	P-2270-BN	120	12	\$135.00
OP-560001	133	---	\$1.80	OP-640027-BN	140	120	\$28.60	P-2280	119	12	\$108.00
OP-590001	91	---	\$1.20	OP-640027-ORB	140	120	\$31.70	P-2280-BN	119	12	\$135.00



## 2018 OLYMPIA PRODUCT CATALOG PRICE INDEX

MODEL	PAGE	PCS/CS	LIST PRICE	MODEL	PAGE	PCS/CS	LIST PRICE	MODEL	PAGE	PCS/CS	LIST PRICE
P-2290	117	12	\$115.00	P-2351T	123	12	\$70.50	P-2395T-6-BN	116	12	\$173.40
P-2290-BN	117	12	\$145.00	P-2352T	123	12	\$70.50	P-2395T-BN	116	12	\$150.00
P-2300B	135	12	\$88.00	P-2352T-BN	123	12	\$125.00	P-2396T	117	12	\$140.00
P-2300B-B	135	12	\$86.00	P-2360T	124	12	\$73.00	P-2396T-BN	117	12	\$210.00
P-2300T	122	12	\$60.50	P-2360T-BN	124	12	\$120.00	P-2397T	117	12	\$120.00
P-2300T-ADA	125	4	\$273.50	P-2362T	124	12	\$57.00	P-2397T-BN	117	12	\$180.00
P-2300T-BN	122	12	\$93.00	P-2362T-BN	124	12	\$98.00	P-2398T	117	12	\$155.00
P-2300T-MZ	122	12	\$112.50	P-2363T	124	12	\$41.00	P-2398T-6	117	12	\$168.00
P-2300T-ORB	122	12	\$107.00	P-2370T	120	12	\$95.00	P-2398T-6-BN	117	12	\$252.00
P-2301B	135	12	\$104.00	P-2370T-BN	120	12	\$142.50	P-2398T-BN	117	12	\$232.50
P-2301B-B	135	12	\$102.00	P-2371T	120	12	\$85.00	P-2400B	135	12	\$83.50
P-2301T	122	12	\$44.50	P-2371T-BN	120	12	\$127.50	P-2400B-B	135	12	\$81.50
P-2301T-BN	122	12	\$77.00	P-2372T	120	12	\$85.00	P-2403B	135	12	\$90.50
P-2301T-ORB	122	12	\$88.00	P-2372T-BN	120	12	\$127.50	P-2403B-B	135	12	\$88.50
P-2302B	135	12	\$104.00	P-2373T	120	12	\$65.00	P-2405B	135	12	\$96.50
P-2302B-B	135	12	\$102.00	P-2373T-BN	120	12	\$97.50	P-2405B-B	135	12	\$94.50
P-2302T	122	12	\$44.50	P-2374T	120	12	\$138.50	P-2407B	137	12	\$102.50
P-2302T-ADA	125	4	\$257.50	P-2374T-BN	120	12	\$207.75	P-2407B-B	137	12	\$100.50
P-2302T-BN	122	12	\$77.00	P-2375T	120	12	\$123.50	P-3210	129	12	\$113.00
P-2302T-ORB	122	12	\$88.00	P-2375T-BN	120	12	\$185.25	P-3220	128	12	\$110.50
P-2303B	136	12	\$98.00	P-2380T	118	12	\$95.00	P-3230	130	6	\$144.00
P-2303B-B	136	12	\$96.00	P-2380T-BN	118	12	\$142.50	P-3230-BN	130	6	\$192.00
P-2303T	122	12	\$27.50	P-2381T	118	12	\$85.00	P-3250	131	6	\$149.00
P-2303T-ADA	125	4	\$187.00	P-2381T-BN	118	12	\$127.50	P-3250-BN	131	6	\$198.00
P-2304B	136	6	\$121.00	P-2382T	118	12	\$85.00	P-4420	132	12	\$151.00
P-2304B-B	136	6	\$119.00	P-2382T-BN	118	12	\$127.50	P-4420-BN	132	12	\$260.00
P-2305B	136	12	\$102.00	P-2383T	119	12	\$65.00	P-4420-ORB	132	12	\$286.00
P-2305B-B	136	12	\$100.00	P-2383T-BN	119	12	\$97.50	P-4430	132	12	\$144.00
P-2306B	136	6	\$121.00	P-2384T	118	12	\$138.50	P-4430-BN	132	12	\$248.00
P-2306B-B	136	6	\$119.00	P-2384T-BN	118	12	\$207.75	P-4430-MZ	132	12	\$287.00
P-2307B	137	12	\$107.00	P-2385T	118	12	\$123.50	P-4430-ORB	132	12	\$273.00
P-2307B-B	137	12	\$105.00	P-2385T-BN	118	12	\$185.25	P-4432-E1.5	132	12	\$159.50
P-2308B	137	12	\$109.00	P-2386T	119	12	\$106.00	P-4432-E1.5-BN	132	12	\$273.50
P-2308B-B	137	12	\$107.00	P-2386T-BN	119	12	\$159.00				
P-2309B	137	6	\$121.00	P-2387T	119	12	\$96.00				
P-2309B-B	137	6	\$119.00	P-2387T-BN	119	12	\$144.00				
P-2310T	122	12	\$63.00	P-2390T	116	12	\$100.00				
P-2312T	122	12	\$47.00	P-2390T-BN	116	12	\$150.00				
P-2340T	123	12	\$69.00	P-2391T	116	12	\$90.00				
P-2340T-BN	123	12	\$117.50	P-2391T-BN	116	12	\$135.00				
P-2340T-MZ	123	12	\$142.00	P-2392T	116	12	\$90.00				
P-2340T-ORB	123	12	\$135.00	P-2392T-BN	116	12	\$135.00				
P-2342T	123	12	\$53.00	P-2393T	117	12	\$68.00				
P-2342T-BN	123	12	\$94.00	P-2393T-BN	117	12	\$102.00				
P-2342T-MZ	123	12	\$113.50	P-2394T	116	12	\$110.00				
P-2342T-ORB	123	12	\$108.00	P-2394T-6	116	12	\$123.00				
P-2343T	123	12	\$37.00	P-2394T-6-BN	116	12	\$184.50				
P-2343T-BN	123	12	\$63.00	P-2394T-BN	116	12	\$165.00				
P-2350T	123	12	\$86.50	P-2395T	116	12	\$100.00				
P-2350T-BN	123	12	\$141.00	P-2395T-6	116	12	\$115.60				

# 2018 OLYMPIA PRODUCT CATALOG PRICE INDEX

# KITCHEN // Single Handle Faucets

## SINGLE HANDLE PULL-DOWN KITCHEN FAUCETS

	Model#	Description	Finish	Case	Price
	K-5020	Single Handle Pull-Down Kitchen Faucet Lever Handle	Chrome	6	\$225.00
	K-5020-BN	Pull-Down Head with 2 Spray Patterns Swivel 360° 7-5/8" Reach, 8-5/8" From Deck to Aerator Ceramic Disc Cartridge 1 or 3-Hole 8" Installation Ball Joint Swivel Spray Head Easy-Install 30" Flex Supply Lines With 3/8" Connections With 1.8 GPM Flow Rate Deck Cover Plate Included	PVD Brushed Nickel	6	\$282.50
	K-5025	Single Handle Pull-Down Kitchen Faucet Lever Handle	Chrome	6	\$238.00
	K-5025-BN	Pull-Down Head with 2 Spray Patterns Swivel 360° 7-5/8" Reach, 8-3/4" From Deck to Aerator Ceramic Disc Cartridge 1 or 3-Hole 8" Installation Ball Joint Swivel Spray Head Easy-Install 30" Flex Supply Lines With 3/8" Connections With 1.8 GPM Flow Rate Deck Cover Plate Included	PVD Brushed Nickel	6	\$299.00
<b>PARTS</b>	OP-120004	Lever Handle	Chrome	---	\$15.00
	OP-390003	Ceramic Disc Cartridge	---	---	\$13.00
	OP-420045	Deck Plate	Chrome	---	\$12.60
	OP-420054	Pull Down Spray Head	Chrome	---	\$24.00
	OP-420055	Spray Hose and O-ring	---	---	\$10.00
	OP-420056	Spout Repair Kit	---	---	\$0.90
	OP-420057	Locknut	---	---	\$3.20
	OP-420058	Cap	Chrome	---	\$6.40
	OP-420059	Washer	---	---	\$0.70
	OP-420060	O-Ring	---	---	\$0.50
	OP-420061	Allen Screw	---	---	\$0.70
	OP-420062	Weight	---	---	\$10.00
	OP-520003	Mounting Kit	---	---	\$2.50
	OP-520005	Mounting Kit	---	---	\$4.20
	OP-520012	Mounting Tool	---	---	\$5.00

Low flow spray head available upon request for the K-5020.

Olympia faucets feature aerators that meet ANSI/ASME A112.18.1 flow requirements of 1.8 GPM

# KITCHEN // Single Handle Faucets

## SINGLE HANDLE PULL-DOWN KITCHEN FAUCETS

	Model#	Description	Finish	Case	Price
	K-5040	Single Handle Pull-Down Kitchen Faucet Lever Handle	Chrome	6	\$225.00
	K-5040-BN	Pull-Down Head with 2 Spray Patterns Swivel 360° 8" Reach, 7-1/2" From Deck to Aerator	PVD Brushed Nickel	6	\$281.00
	K-5040-ORB	Ceramic Disc Cartridge with Temperature Limit Stop 1 or 3-Hole 8" Installation	Oil Rubbed Bronze	6	\$314.50
	K-5040-MZ	Ball Joint Swivel Spray Head Easy-Install 30" Flex Supply Lines With 3/8" Connections With 1.8 GPM Flow Rate Deck Cover Plate Included	Moroccan Bronze	6	\$330.50

## SINGLE HANDLE KITCHEN FAUCETS

	Model#	Description	Finish	Case	Price
	K-5441	Single Handle Kitchen Faucet Lever Handle	Chrome	6	\$253.50
	K-5441-BN	Gooseneck Spout Swivel 360° 8-1/4" Reach, 10-3/8" From Deck to Aerator Ceramic Disc Cartridge with Temperature Limit Stop 2 or 4-Hole Installation Side Spray Assembly With 1.5 GPM Flow Rate	PVD Brushed Nickel	6	\$305.50

**PARTS**





OP-120002	Lever Handle	Chrome	---	\$15.90
OP-320002	Ceramic Cartridge	---	---	\$14.80
OP-420062	Hose Weight	---	---	\$9.80
OP-420024	Diverter Piston	---	---	\$5.30
OP-420038	Hose And Spray Assembly	Chrome	---	\$21.00
OP-420039	Spray Head and Hose	Chrome	---	\$31.70
OP-420041	Spout Repair Kit	---	---	\$0.90
OP-420042	Retainer Nut	---	---	\$3.20
OP-420043	Cap	Chrome	---	\$6.40
OP-420044	Washer	---	---	\$0.70
OP-420045	Deck Plate	Chrome	---	\$12.60
OP-420046	Spray Head Push Button	---	---	\$1.10
OP-420047	Allen Screw	---	---	\$0.70
OP-420049	Spout Repair Kits	---	---	\$5.30
OP-420050	Cap & Washer	---	---	\$2.40
OP-520005	Mounting Kit	---	---	\$4.20
OP-520012	Mounting Tool	---	---	\$18.90
OP-420064	Spray Head-1.8 GPM	Chrome	---	\$31.70
OP-420040	Spray Head and Hose-1.5 GPM	Chrome	---	\$38.80
OP-420048	Aerator-1.5 GPM	Chrome	---	\$6.40

Low flow spray head available upon request for the K-5040.

Olympia faucets feature aerators that meet ANSI/ASME A112.18.1 flow requirements of 1.8 GPM

# KITCHEN // Single Handle Faucets

## SINGLE HANDLE PULL-OUT KITCHEN FAUCETS











		Model#	Description	Finish	Case	Price
	  	K-5030	Single Handle Pull-Out Kitchen Faucet Metal Lever Handle	Chrome	6	\$163.00
		K-5030-BN	Pull-Out Head with 2 Spray Patterns Swivel 180° 8-3/4" Reach, 5-3/16" From Deck to Aerator	PVD Brushed Nickel	6	\$203.50
		K-5030-ORB	Ceramic Disc Cartridge with Temperature Limit Stop 1 or 3-Hole 8" Installation Easy-Install 30" Flex Supply Lines With 3/8" Connections With 1.8 GPM Flow Rate Deck Cover Plate Included	Oil Rubbed Bronze	6	\$224.00
<b>PARTS</b>		OP-120001	Metal Lever Handle Set	Chrome	---	\$17.40
		OP-120003	Metal Loop Handle Set	Chrome	---	\$22.00
		OP-320001	Ceramic Cartridge	---	---	\$13.80
		OP-420008	Cap	Chrome	---	\$5.30
		OP-420009	Retainer Ring	---	---	\$7.60
		OP-420010	Spout O-Rings	---	---	\$0.70
		OP-420011	Spray Head Guide	---	---	\$0.70
		OP-420013	Deck Plate	Chrome	---	\$16.40
		OP-420014	Hose Weight	---	---	\$9.80
		OP-420015	Spray Hose	Chrome	---	\$27.60
		OP-420017	Spray Head Button	---	---	\$0.70
		OP-490005	Lever Handle Index Button	---	---	\$0.70
		OP-490029	Handle Set Screw	---	---	\$0.70
		OP-520003	Mounting Hardware	---	---	\$2.50
		OP-520004	Locknut	---	---	\$3.00
		OP-520006	1-Hole Mounting Assembly	Chrome	---	\$11.60
		OP-520012	Mounting Tool	---	---	\$4.20
		OP-420063	Spray Head-1.8 GPM	Chrome	---	\$22.00
		OP-420012	Spray Head-1.5 GPM	Chrome	---	\$22.00

Low flow spray head available upon request.

Olympia faucets feature aerators that meet ANSI/ASME A112.18.1 flow requirements of 1.5 GPM

# KITCHEN // Single Handle Faucets

## SINGLE HANDLE KITCHEN FAUCETS

		Model#	Description	Finish	Case	Price
		K-4160	Single Handle Kitchen Faucet Metal Lever Handle	Chrome	12	\$76.00
		K-4160-BN	Spout Swivel 360°	PVD Brushed Nickel	12	\$104.00
		K-4160-ORB	7-15/16" Reach, 4-3/4" From Deck to Aerator Stainless Steel Ball Operation	Oil Rubbed Bronze	12	\$116.50
		K-4160B*	3-Hole 8" Installation With 1.5 GPM Flow Rate	Chrome	12	\$74.00
		K-4160B-BN*	*Builder Tract Pack	PVD Brushed Nickel	12	\$102.00
		K-4160H**	**Easy-Install 30" Flex Supply Lines With 3/8" Connections	Chrome	12	\$86.00
		K-4161	Single Handle Kitchen Faucet Metal Lever Handle	Chrome	12	\$90.50
		K-4161-BN	Spout Swivel 360°	Chrome	12	\$117.00
		K-4161B*	7-15/16" Reach, 4-3/4" From Deck to Aerator Stainless Steel Ball Operation	Chrome	12	\$88.50
		K-4161B-BN*	4-Hole 8" Installation With 1.5 GPM Flow Rate	PVD Brushed Nickel	12	\$115.00
		K-4161H**	Side Spray Assembly *Builder Tract Pack	Chrome	12	\$100.50
		K-4161H-BN**	**Easy-Install 30" Flex Supply Lines With 3/8" Connections	PVD Brushed Nickel	12	\$126.50
		K-4162	Single Handle Kitchen Faucet Metal Lever Handle	Chrome	12	\$100.00
		K-4162-BN	Spout Swivel 360°	PVD Brushed Nickel	12	\$129.50
		K-4162B*	7-15/16" Reach, 4-3/4" From Deck to Aerator Stainless Steel Ball Operation 4-Hole 8" Installation With 1.5 GPM Flow Rate Side Spray Assembly *Builder Tract Pack	Chrome	12	\$98.00
		K-4163	Single Handle Kitchen Faucet Metal Lever Handle Spout Swivel 360° 7-15/16" Reach, 4-3/4" From Deck to Aerator Stainless Steel Ball Operation 3-Hole 8" Installation With 1.5 GPM Flow Rate Side Spray Assembly On Deck	Chrome	12	\$93.00
		K-4164	Single Handle Kitchen Faucet Metal Lever Handle Spout Swivel 360° 7-15/16" Reach, 4-3/4" From Deck to Aerator Stainless Steel Ball Operation 3-Hole 8" Installation With 1.5 GPM Flow Rate Side Spray Assembly On Deck	Chrome	12	\$102.50





Builder Tract Packs sold in case quantities only.  
Low flow spray head available upon request.

Olympia faucets feature aerators that meet ANSI/ASME A112.18.1 flow requirements of 1.5 GPM

KITCHEN

# KITCHEN // Single Handle Faucets















## SINGLE HANDLE KITCHEN FAUCETS

		Model#	Description	Finish	Case	Price
		K-4170	Single Handle Kitchen Faucet Metal Loop Handle	Chrome	12	\$76.00
		K-4170-BN	Spout Swivel 360° 7-15/16" Reach, 4-3/4" From Deck to Aerator Stainless Steel Ball Operation 3-Hole 8" Installation With 1.5 GPM Flow Rate	PVD Brushed Nickel	12	\$99.50
		K-4171	Single Handle Kitchen Faucet Metal Loop Handle Spout Swivel 360° 7-15/16" Reach, 4-3/4" From Deck to Aerator Stainless Steel Ball Operation 4-Hole 8" Installation With 1.5 GPM Flow Rate Side Spray Assembly	Chrome	12	\$90.50
<b>PARTS</b>		OP-190001	Metal Lever Handle	Chrome	---	\$13.30
		OP-190002	Metal Loop Handle	Chrome	---	\$13.30
		OP-220001	D Style Spout	Chrome	---	\$37.30
		OP-390001	Stainless Steel Ball	---	---	\$3.50
		OP-420001	Spout O-Rings	---	---	\$0.70
		OP-420002	Spout Gasket	---	---	\$0.70
		OP-420003	Deck Plate	Chrome	---	\$20.40
		OP-420004	Mounting Gasket	---	---	\$1.80
		OP-420005	Diverter Piston	---	---	\$2.40
		OP-420006	Deck Plate	Chrome	---	\$13.80
		OP-420052	Hose And Spray Assembly	Black	---	\$23.00
		OP-420051	Hose And Spray Assembly	Black	---	\$23.00
		OP-420037	Hose And Spray Assembly	Chrome	---	\$19.40
		OP-420038	Hose And Spray Assembly	Chrome	---	\$21.00
		OP-490002	Lever Handle Index Button	---	---	\$0.70
		OP-490003	Cap and Adjusting Ring	Chrome	---	\$7.00
		OP-490004	Cam and Washer	---	---	\$4.60
		OP-490041	Springs and Seats	---	---	\$1.20
		OP-490043	Lever Handle Allen Screw 1/8"	---	---	\$0.70
		OP-520001	Mounting Hardware	---	---	\$1.80
		OP-520002	Mounting Hardware	---	---	\$2.20
		OP-590001	Brass Supply Nut	---	---	\$1.20
		OP-490035	Aerator-1.5 GPM	Chrome	---	\$6.90
	OP-490056	Aerator-1.0 GPM	Chrome	---	\$9.90	
	OP-490055	Aerator-0.5 GPM	Chrome	---	\$8.80	

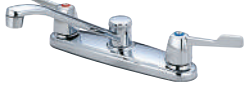
Olympia faucets feature aerators that meet ANSI/ASME A112.18.1 flow requirements of 1.5 GPM

# KITCHEN // Two Handle Faucets

## TWO HANDLE KITCHEN FAUCETS

		Model#	Description	Finish	Case	Price
		K-5120	Two Handle Kitchen Faucet Acrylic Round Handles Spout Swivel 360° 7-9/16" Reach, 4-5/8" From Deck to Aerator Washerless Cartridge Operation 3-Hole 8" Installation With 1.5 GPM Flow Rate *Builder Tract Pack	Chrome	12	\$72.00
		K-5121	Two Handle Kitchen Faucet Acrylic Round Handles Spout Swivel 360° 7-9/16" Reach, 4-5/8" From Deck to Aerator Washerless Cartridge Operation 4-Hole 8" Installation With 1.5 GPM Flow Rate Side Spray Assembly	Chrome	12	\$82.00
		K-5130	Two Handle Kitchen Faucet Mini Blade Handles Spout Swivel 360° 7-9/16" Reach, 4-5/8" From Deck to Aerator Washerless Cartridge Operation 3-Hole 8" Installation With 1.5 GPM Flow Rate	Chrome	12	\$73.50
		K-5131	Two Handle Kitchen Faucet Mini Blade Handles Spout Swivel 360° 7-9/16" Reach, 4-5/8" From Deck to Aerator Washerless Cartridge Operation 4-Hole 8" Installation With 1.5 GPM Flow Rate Side Spray Assembly	Chrome	12	\$83.50
		K-5150	Two Handle Kitchen Faucet ADA Wrist Blade Handles Spout Swivel 360° 7-9/16" Reach, 4-5/8" From Deck to Aerator Washerless Cartridge Operation 3-Hole 8" Installation With 1.5 GPM Flow Rate	Chrome	12	\$78.00
		K-5270	Two Handle Kitchen Faucet Lever Handles With White & Chrome Inserts High Arc Spout Swivel 360° 6-3/4" Reach, 9-13/16" From Deck to Aerator Washerless Cartridge Operation 3-Hole 8" Installation With 1.5 GPM Flow Rate	Chrome	12	\$80.50
		K-5271	Two Handle Kitchen Faucet Lever Handles With White & Chrome Inserts High Arc Spout Swivel 360° 6-3/4" Reach, 9-13/16" From Deck to Aerator Washerless Cartridge Operation 4-Hole 8" Installation With 1.5 GPM Flow Rate Side Spray Assembly	Chrome	12	\$90.50

Olympia faucets feature aerators that meet ANSI/ASME A112.18.1 flow requirements of 1.5 GPM

KITCHEN

# KITCHEN // Two Handle Faucets

## TWO HANDLE KITCHEN FAUCETS

	Model#	Description	Finish	Case	Price
<b>PARTS</b>	OP-190003C	Acrylic Round Handle-Cold	---	---	\$3.50
	OP-190003H	Acrylic Round Handle-Hot	---	---	\$3.50
	OP-190004C	Mini Blade Handle-Cold	Chrome	---	\$4.10
	OP-190004H	Mini Blade Handle-Hot	Chrome	---	\$4.10
	OP-190005C	ADA Wrist Blade Square Handle Set-Cold	Chrome	---	\$9.80
	OP-190005H	ADA Wrist Blade Square Handle Set-Hot	Chrome	---	\$9.80
	OP-190006C	Handle Hub-Cold	Chrome	---	\$9.80
	OP-190006H	Handle Hub-Hot	Chrome	---	\$9.80
	OP-220002	D Style Spout	Chrome	---	\$31.70
	OP-220003	High Arc Spout	Chrome	---	\$43.40
	OP-390004	Stem Unit-Brass Post	---	---	\$4.60
	OP-390005	Stem Unit-Plastic Post	---	---	\$4.60
	OP-420018	D Style Spout Cap and Packing	Chrome	---	\$3.50
	OP-420019	D Style Spout O-Ring	---	---	\$0.70
	OP-420020	D Style Spout Gasket	---	---	\$0.70
	OP-420021	High Arc Spout Bonnet Nut	---	---	\$4.10
	OP-420051	Hose And Spray Assembly	Black	---	\$23.00
	OP-420024	Diverter Piston	---	---	\$5.30
	OP-420025	Deck Plate	Chrome	---	\$12.30
	OP-420026	Mounting Gasket	---	---	\$1.20
	OP-490012C	Acrylic Handle Button-Cold	---	---	\$1.20
	OP-490012H	Acrylic Handle Button-Hot	---	---	\$1.20
	OP-490013C	Mini Blade Handle Button-Cold	---	---	\$1.20
	OP-490013H	Mini Blade Handle Button-Hot	---	---	\$1.20
	OP-490014	Handle Screw	---	---	\$0.70
	OP-490015	ADA Wrist Blade Square Handle Screw	---	---	\$0.70

# KITCHEN // Two Handle Faucets

## TWO HANDLE KITCHEN FAUCETS

	Model#	Description	Finish	Case	Price
<b>PARTS</b>	OP-490016C	ADA Wrist Blade Square Handle Index-Cold	---	---	\$0.70
	OP-490016H	ADA Wrist Blade Square Handle Index-Hot	---	---	\$0.70
	OP-490017	Lever Handle Insert-Chrome	Chrome	---	\$6.50
	OP-490018	Lever Handle Insert-White	---	---	\$3.00
	OP-490029	Handle Set Screw	---	---	\$0.70
	OP-490038	Snap Ring	---	---	\$0.70
	OP-490039	Spout O-Ring	---	---	\$0.70
	OP-490040	Bonnet Nut	---	---	\$2.40
	OP-490041	Springs and Seats	---	---	\$1.20
	OP-490042	Bell Hub Lever Handle Screw	---	---	\$1.20
	OP-590001	Brass Supply Nut	---	---	\$1.20
	OP-520009	Mounting Hardware	---	---	\$3.40
	OP-490010	Aerator-1.5 GPM	Chrome	---	\$5.70
	OP-490058	Aerator-1.0 GPM	Chrome	---	\$8.80
	OP-490059	Aerator-0.5 GPM	Chrome	---	\$8.80
	OP-490035	Aerator-1.5 GPM	Chrome	---	\$6.90
	OP-490056	Aerator-1.0 GPM	Chrome	---	\$9.90
	OP-490055	Aerator-0.5 GPM	Chrome	---	\$8.80

# KITCHEN // Two Handle Faucets



## TWO HANDLE KITCHEN FAUCETS

		Model#	Description	Finish	Case	Price
		K-5160	Two Handle Kitchen Faucet Lever Handles Spout Swivel 360° 7-9/16" Reach, 4-5/8" From Deck to Aerator Washerless Cartridge Operation 3-Hole 8" Installation With 1.5 GPM Flow Rate	Chrome	12	\$79.00
		K-5161	Two Handle Kitchen Faucet Lever Handles Spout Swivel 360° 7-9/16" Reach, 4-5/8" From Deck to Aerator Washerless Cartridge Operation 4-Hole 8" Installation With 1.5 GPM Flow Rate Side Spray Assembly	Chrome	12	\$89.00
		K-5170	Two Handle Kitchen Faucet Lever Handles Spout Swivel 360° 7-9/16" Reach, 4-5/8" From Deck to Aerator Washerless Cartridge Operation 3-Hole 8" Installation With 1.5 GPM Flow Rate	Chrome	12	\$84.00
		K-5171	Two Handle Kitchen Faucet Lever Handles Spout Swivel 360° 7-9/16" Reach, 4-5/8" From Deck to Aerator Washerless Cartridge Operation 4-Hole 8" Installation With 1.5 GPM Flow Rate Side Spray Assembly	Chrome	12	\$94.00
		K-5340	Two Handle Kitchen Faucet Lever Handles	Chrome	6	\$88.50
		K-5340-BN	Gooseneck Spout Swivel 360° 8-7/16" Reach, 8-1/8" From Deck to Aerator Washerless Cartridge Operation 3-Hole 8" Installation With 1.5 GPM Flow Rate	PVD Brushed Nickel	6	\$128.00
		K-5350*	Gooseneck Spout Swivel 360° 8-7/16" Reach, 8-1/8" From Deck to Aerator Washerless Cartridge Operation 3-Hole 8" Installation With 1.5 GPM Flow Rate  *ADA Wrist Blade Handles	Chrome	6	\$93.00
		K-5342	Two Handle Kitchen Faucet Lever Handles	Chrome	6	\$108.00
		K-5342-BN	Gooseneck Spout Swivel 360° 8-7/16" Reach, 8-1/8" From Deck to Aerator Washerless Cartridge Operation 4-Hole 8" Installation With 1.5 GPM Flow Rate Side Spray Assembly	PVD Brushed Nickel	6	\$152.50
		K-5342-ORB	Gooseneck Spout Swivel 360° 8-7/16" Reach, 8-1/8" From Deck to Aerator Washerless Cartridge Operation 4-Hole 8" Installation With 1.5 GPM Flow Rate Side Spray Assembly	Oil Rubbed Bronze	6	\$171.00
		K-5370	Two Handle Kitchen Faucet Lever Handles	Chrome	6	\$93.50
		K-5370-BN	Gooseneck Spout Swivel 360° 8-7/16" Reach, 8-1/8" From Deck to Aerator Washerless Cartridge Operation 3-Hole 8" Installation With 1.5 GPM Flow Rate	PVD Brushed Nickel	6	\$135.50

Olympia faucets feature aerators that meet ANSI/ASME A112.18.1 flow requirements of 1.5 GPM

# KITCHEN // Two Handle Faucets

















## TWO HANDLE KITCHEN FAUCETS

	Model#	Description	Finish	Case	Price
 	K-5372	Two Handle Kitchen Faucet Lever Handles Gooseneck Spout Swivel 360° 8-7/16" Reach, 8-1/8" From Deck to Aerator Washerless Cartridge Operation 4-Hole 8" Installation With 1.5 GPM Flow Rate Side Spray Assembly	Chrome	6	\$113.00
	<b>PARTS</b>				
	OP-190010C	Lever Handle-Cold	Chrome	---	\$13.30
	OP-190010H	Lever Handle-Hot	Chrome	---	\$13.30
	OP-190014C	ADA Wrist Blade Handle-Cold	Chrome	---	\$13.30
	OP-190014H	ADA Wrist Blade Handle-Hot	Chrome	---	\$13.30
	OP-190015C	Lever Handle-Cold	Chrome	---	\$14.30
	OP-190015H	Lever Handle-Hot	Chrome	---	\$14.30
	OP-220004	High Gooseneck Spout	Chrome	---	\$34.70
	OP-220005	High Gooseneck Spout	Chrome	---	\$28.60
	OP-390004	Stem Unit-Brass Post	---	---	\$4.60
	OP-420051	Hose and Spray Assembly	Black	---	\$23.00
	OP-420024	Diverter Piston	---	---	\$5.30
	OP-420025	Deck Plate	Chrome	---	\$12.30
	OP-420026	Mounting Gasket	---	---	\$1.20
	OP-420038	Hose And Spray Assembly	Chrome	---	\$21.00
	OP-450010	Spout Bonnet Nut	Chrome	---	\$8.70
	OP-490028	Spout Bonnet Nut	Chrome	---	\$7.60
	OP-490029	Handle Set Screw	---	---	\$0.70
	OP-490038	Snap Ring	---	---	\$0.70
	OP-490039	Spout O-Ring	---	---	\$0.70
	OP-490040	Bonnet Nut	---	---	\$2.40
	OP-490041	Springs and Seats	---	---	\$1.20
	OP-590001	Brass Supply Nut	---	---	\$1.20
	OP-520009	Mounting Hardware	---	---	\$3.40
	OP-490057	Aerator-1.5 GPM	Chrome	---	\$8.80
	OP-490060	Aerator-1.0 GPM	Chrome	---	\$11.10
	OP-490061	Aerator-0.5 GPM	Chrome	---	\$11.10
	OP-490035	Aerator-1.5 GPM	Chrome	---	\$6.90
	OP-490056	Aerator-1.0 GPM	Chrome	---	\$9.90
	OP-490055	Aerator-0.5 GPM	Chrome	---	\$8.80

Olympia faucets feature aerators that meet ANSI/ASME A112.18.1 flow requirements of 1.5 GPM

# BAR & LAUNDRY // Two Handle Faucets









## TWO HANDLE BAR / LAUNDRY FAUCETS

		Model#	Description	Finish	Case	Price
	  	B-8170	Two Handle Bar Faucet ADA Wrist Blade Handles Gooseneck Spout Swivel 360° 5-1/4" Reach, 5-5/8" From Deck to Aerator Washerless Cartridge Operation 2 or 3-Hole 4" Installation With 1.5 GPM Flow Rate	Chrome	12	\$75.50
	  	B-8171	Two Handle Bar Faucet Mini Blade Handles Gooseneck Spout Swivel 360° 5-1/4" Reach, 5-5/8" From Deck to Aerator Washerless Cartridge Operation 2 or 3-Hole 4" Installation With 1.5 GPM Flow Rate	Chrome	12	\$63.50
	  	B-8180	Two Handle Bar Faucet ADA Wrist Blade Handles Gooseneck Spout Swivel 360° 3-9/16" Reach, 6-15/16" From Deck to Aerator Washerless Cartridge Operation 2 or 3-Hole 4" Installation With 1.5 GPM Flow Rate	Chrome	12	\$82.00
	  	B-8181	Two Handle Bar Faucet Mini Blade Handles Gooseneck Spout Swivel 360° 3-9/16" Reach, 6-15/16" From Deck to Aerator Washerless Cartridge Operation 2 or 3-Hole 4" Installation With 1.5 GPM Flow Rate	Chrome	12	\$70.00

Olympia faucets feature aerators that meet ANSI/ASME A112.18.1 flow requirements of 1.5 GPM

# BAR & LAUNDRY // Two Handle Faucets









## TWO HANDLE BAR / LAUNDRY FAUCETS

		Model#	Description	Finish	Case	Price
	  	B-8190	Two Handle Laundry Faucet ADA Wrist Blade Handles Hi-Tubular Spout Swivel 360° 5-1/2" Reach, 5-13/16" From Deck to Aerator Washerless Cartridge Operation 2 or 3-Hole 4" Installation With 1.5 GPM Flow Rate	Chrome	12	\$76.50
	  	B-8191	Two Handle Laundry Faucet Mini Blade Handles Hi-Tubular Spout Swivel 360° 5-1/2" Reach, 5-13/16" From Deck to Aerator Washerless Cartridge Operation 2 or 3-Hole 4" Installation With 1.5 GPM Flow Rate	Chrome	12	\$64.50
<b>PARTS</b>		OP-190004C	Mini Blade Handle-Cold	Chrome	---	\$4.10
		OP-190004H	Mini Blade Handle-Hot	Chrome	---	\$4.10
		OP-190014C	ADA Wrist Blade Handle-Cold	Chrome	---	\$13.30
		OP-190014H	ADA Wrist Blade Handle-Hot	Chrome	---	\$13.30
		OP-250004	8-15/16" High Spout	Chrome	---	\$30.10
		OP-250005	9-7/8" High Gooseneck Spout	Chrome	---	\$27.10
		OP-250007	7-9/16" Hi Tubular Spout	Chrome	---	\$28.60
		OP-390004	Stem Unit-Brass Post	---	---	\$4.60
		OP-390005	Stem Unit-Plastic Post	---	---	\$4.60
		OP-450010	Spout Bonnet Nut	Chrome	---	\$8.70
		OP-450011	Deck Plate	Chrome	---	\$11.00
		OP-450012	Mounting Gasket	---	---	\$1.20
		OP-450013	ADA Wrist Blade Handle Screw	---	---	\$0.70
		OP-450014	Hose Thread Adapter	Chrome	---	\$2.40
		OP-490001C	ADA Wrist Blade Handle Index-Cold	---	---	\$1.20
		OP-490001H	ADA Wrist Blade Handle Index-Hot	---	---	\$1.20
		OP-490013C	Mini Blade Handle Button-Cold	---	---	\$1.20
		OP-490013H	Mini Blade Handle Button-Hot	---	---	\$1.20
		OP-490014	Handle Screw	---	---	\$0.70
		OP-490038	Snap Ring	---	---	\$0.70
		OP-490039	Spout O-Ring	---	---	\$0.70
		OP-490040	Bonnet Nut	---	---	\$2.40
		OP-490041	Springs and Seats	---	---	\$1.20
		OP-590001	Brass Supply Nut	---	---	\$1.20
		OP-590003	Mounting Hardware	---	---	\$2.40
		OP-490035	Aerator-1.5 GPM	Chrome	---	\$6.90
		OP-490056	Aerator-1.0 GPM	Chrome	---	\$9.90
		OP-490055	Aerator-0.5 GPM	Chrome	---	\$8.80

Olympia faucets feature aerators that meet ANSI/ASME A112.18.1 flow requirements of 1.5 GPM

# BAR // Two Handle Faucets

## TWO HANDLE BAR FAUCETS







		Model#	Description	Finish	Case	Price
	  	B-8160	Two Handle Bar Faucet Lever Handles	Chrome	12	\$74.00
		B-8160-BN	Gooseneck Spout Swivel 360° 5-1/4" Reach, 5-13/16" From Deck to Aerator Washerless Cartridge Operation 2 or 3-Hole 4" Installation With 1.5 GPM Flow Rate	PVD Brushed Nickel	12	\$93.50
	  	B-8150	Two Handle Bar Faucet Lever Handles	Chrome	12	\$79.00
		B-8150-BN	Gooseneck Spout Swivel 360° 5-1/4" Reach, 5-13/16" From Deck to Aerator Washerless Cartridge Operation 2 or 3-Hole 4" Installation With 1.5 GPM Flow Rate	PVD Brushed Nickel	12	\$100.00
<b>PARTS</b>		OP-190010C	Lever Handle-Cold	Chrome	---	\$13.30
		OP-190010H	Lever Handle-Hot	Chrome	---	\$13.30
		OP-190015C	Lever Handle-Cold	Chrome	---	\$14.30
		OP-190015H	Lever Handle-Hot	Chrome	---	\$14.30
		OP-250002	8-15/16" High Spout	Chrome	---	\$30.10
		OP-390004	Stem Unit-Brass Post	---	---	\$4.60
		OP-450002	Bonnet Nut	Chrome	---	\$2.40
		OP-450003	Bonnet Nut Gasket	---	---	\$0.70
		OP-450004	Deck Plate	Chrome	---	\$11.00
		OP-450005	Mounting Gasket	---	---	\$1.80
		OP-490028	Spout Bonnet Nut	Chrome	---	\$7.60
		OP-490029	Handle Set Screw	---	---	\$0.70
		OP-490038	Snap Ring	---	---	\$0.70
		OP-490039	Spout O-Ring	---	---	\$0.70
		OP-490041	Springs and Seats	---	---	\$1.20
		OP-590001	Brass Supply Nut	---	---	\$1.20
		OP-590003	Mounting Hardware	---	---	\$2.40
		OP-490057	Aerator-1.5 GPM	Chrome	---	\$8.80
		OP-490060	Aerator-1.0 GPM	Chrome	---	\$11.10
		OP-490061	Aerator-0.5 GPM	Chrome	---	\$11.10
		OP-490035	Aerator-1.5 GPM	Chrome	---	\$6.90
		OP-490056	Aerator-1.0 GPM	Chrome	---	\$9.90
		OP-490055	Aerator-0.5 GPM	Chrome	---	\$8.80

Olympia faucets feature aerators that meet ANSI/ASME A112.18.1 flow requirements of 1.5 GPM

# LAVATORY // Single Handle Faucets

## NEW FAUCETS

### SINGLE HANDLE LAVATORY FAUCETS

		Model#	Description	Finish	Case	Price
		L-6010	Single Handle Lavatory Faucet Lever Handle	Chrome	12	\$165.00
		L-6010-BN	4-3/8" Reach, 2-5/8" From Deck to Aerator Ceramic Disc Cartridge	PVD Brushed Nickel	12	\$219.45
		L-6010B*	1-Hole Installation 50/50 Pop-Up Drain Assembly Easy-Install 18" Flex Supply Lines With 3/8" Connections With 1.2 GPM Flow Rate  *Builder Tract Pack	Chrome	12	\$163.00
		L-6010-WD	1 or 3 Hole 4" Installation Deck Cover Plate Included	Chrome	12	\$175.00
		L-6010-WD-BN		PVD Brushed Nickel	12	\$233.00
		L-6011	Single Handle Lavatory Faucet Lever Handle	Chrome	12	\$147.00
		L-6011-BN	4-3/8" Reach, 2-5/8" From Deck to Aerator Ceramic Disc Cartridge 1-Hole Installation No Pop-up Hole Easy-Install 18" Flex Supply Lines With 3/8" Connections With 1.2 GPM Flow Rate	PVD Brushed Nickel	12	\$195.60
		L-6011-WD	1 or 3 Hole 4" Installation Deck Cover Plate Included	Chrome	12	\$157.00
		L-6011-WD-BN		PVD Brushed Nickel	12	\$209.00
		L-6012	Single Handle Lavatory Faucet Lever Handle	Chrome	12	\$170.00
		L-6012-BN	4-3/8" Reach, 2-5/8" From Deck to Aerator Ceramic Disc Cartridge	PVD Brushed Nickel	12	\$226.10
		L-6012B*	1-Hole Installation	Chrome	12	\$168.00
		L-6013**	Brass Pop-Up Drain Assembly Easy-Install 18" Flex Supply Lines With 3/8" Connections With 1.2 GPM Flow Rate * Builder Tract Pack ** With Push Down Brass Drain	Chrome	12	\$175.00
		L-6012-WD	1 or 3 Hole 4" Installation Deck Cover Plate Included	Chrome	12	\$180.00
		L-6012-WD-BN		PVD Brushed Nickel	12	\$240.00
PARTS		OP-130002	Lever Handle	Chrome	---	\$18.00
		OP-430021	Cap	Chrome	---	\$6.40
		OP-430032	Locknut	---	---	\$7.00
		X-3300006	Ceramic Disc Cartridge	---	---	\$12.75
		X-4300090	1.5 GPM Laminar	---	---	\$9.00
		OP-430033	Gasket	---	---	\$1.00
		X-4300087	Deck Plate (For L-6010-WD, L-6011-WD, L-6012-WD )	Chrome	---	\$16.50
		OP-530005	Mounting Kit	---	---	\$5.00
		OP-630005	50/50 Pop-Up Drain Assembly (For L-6010, L-6010-WD)	Chrome	---	\$26.00
		OP-630006	Brass Pop-Up Drain Assembly (For L-6012, L-6012-WD)	Chrome	---	\$29.00
		OP-630007	Touch Down Drain (For L-6013)	Chrome	---	\$34.00
		OP-420047	3/32" Allen Screw	---	---	\$0.70
		X-4900044	Hole Cover	Chrome	---	\$2.05



Builder Tract Packs sold in case quantities only.  
Low flow aerators available upon request.

Olympia faucets feature aerators that meet ANSI/ASME A112.18.1 flow requirements of 1.5 GPM

# LAVATORY // Single Handle Faucets

## NEW FAUCETS

### SINGLE HANDLE LAVATORY FAUCETS





	Model#	Description	Finish	Case	Price
	L-6020	Single Handle Lavatory Faucet Lever Handle	Chrome	12	\$155.00
	L-6020-BN	3-5/8" Reach, 3" From Deck to Aerator Ceramic Disc Cartridge	PVD Brushed Nickel	12	\$206.15
	L-6020B*	1-Hole Installation 50/50 Pop-Up Drain Assembly Easy-Install 18" Flex Supply Lines With 3/8" Connections With 1.2 GPM Flow Rate  * Builder Tract Pack	Chrome	12	\$153.00
	L-6020-WD	1 or 3 Hole 4" Installation Deck Cover Plate Included	Chrome	12	\$163.00
	L-6020-WD-BN		PVD Brushed Nickel	12	\$216.80
	L-6021	Single Handle Lavatory Faucet Lever Handle	Chrome	12	\$137.00
	L-6021-BN	3-5/8" Reach, 3" From Deck to Aerator Ceramic Disc Cartridge 1-Hole Installation With Pop-up Hole Cover Easy-Install 18" Flex Supply Lines With 3/8" Connections With 1.2 GPM Flow Rate	PVD Brushed Nickel	12	\$182.25
	L-6021-WD	1 or 3 Hole 4" Installation Deck Cover Plate Included	Chrome	12	\$145.00
	L-6021-WD-BN		PVD Brushed Nickel	12	\$192.85
	L-6022	Single Handle Lavatory Faucet Lever Handle	Chrome	12	\$160.00
	L-6022-BN	3-5/8" Reach, 3" From Deck to Aerator Ceramic Disc Cartridge	PVD Brushed Nickel	12	\$212.80
	L-6022B*	1-Hole Installation	Chrome	12	\$158.00
	L-6023**	Brass Pop-Up Drain Assembly Easy-Install 18" Flex Supply Lines With 3/8" Connections With 1.2 GPM Flow Rate  * Builder Tract Pack ** With Push Down Brass Drain	Chrome	12	\$165.00
	L-6022-WD	1 or 3 Hole 4" Installation Deck Cover Plate Included	Chrome	12	\$168.00
	L-6022-WD-BN		PVD Brushed Nickel	12	\$223.50
<b>PARTS</b>	OP-130003	Lever Handle	Chrome	---	\$16.00
	OP-430021	Cap	Chrome	---	\$6.40
	OP-420042	Locknut	---	---	\$3.20
	OP-320002	Ceramic Disc Cartridge	---	---	\$14.80
	OP-430023	Hole Cover(For L-6021, L-6021-WD, L-6023)	Chrome	---	\$1.00
	X-4300090	1.5 GPM Laminar	---	---	\$9.00
	OP-430025	Gasket	---	---	\$0.70
	OP-430026	Deck Plate (For L-6020-WD, L-6021-WD, L-6022-WD)	Chrome	---	\$16.75
	OP-530005	Mounting Kit	---	---	\$5.00
	OP-630005	50/50 Pop-Up Drain Assembly (For L-6020, L-6020-WD)	Chrome	---	\$26.00
	OP-630006	Brass Pop-Up Drain Assembly (For L-6022, L-6022-WD)	Chrome	---	\$29.00
	OP-630007	Touch Down Drain (For L-6023)	Chrome	---	\$34.00
	OP-420061	3/32" Allen Screw	---	---	\$0.70
	X-4900044	Hole Cover	Chrome	---	\$2.05

Builder Tract Packs sold in case quantities only.  
Low flow aerators available upon request.

Olympia faucets feature aerators that meet ANSI/ASME A112.18.1 flow requirements of 1.2 GPM

# LAVATORY // Single Handle Faucets

## SINGLE HANDLE LAVATORY FAUCETS

	Model#	Description	Finish	Case	Price
	L-6050	Single Handle Lavatory Faucet Lever Handle	Chrome	12	\$147.00
	L-6050-BN	4-3/4" Reach, 2-1/2" From Deck to Aerator Ceramic Disc Cartridge	PVD Brushed Nickel	12	\$196.00
	L-6050B*	1-Hole Installation	Chrome	12	\$145.00
	L-6050B-BN*	50/50 Pop-Up Drain Assembly Easy-Install 18" Flex Supply Lines With 3/8" Connections With 1.2 GPM Flow Rate  *Builder Tract Pack	PVD Brushed Nickel	12	\$194.00
	L-6050-WD	1 or 3 Hole 4" Installation Deck Cover Plate Included	Chrome	12	\$155.00
	L-6050-WD-BN		PVD Brushed Nickel	12	\$206.15
	L-6051	Single Handle Lavatory Faucet Lever Handle	Chrome	12	\$136.00
	L-6051-BN	4-3/4" Reach, 2-1/2" From Deck to Aerator Ceramic Disc Cartridge 1-Hole Installation Easy-Install 18" Flex Supply Lines With 3/8" Connections With 1.2 GPM Flow Rate	PVD Brushed Nickel	12	\$184.00
	L-6051-WD	1 or 3 Hole 4" Installation Deck Cover Plate Included	Chrome	12	\$146.00
	L-6051-WD-BN		PVD Brushed Nickel	12	\$197.00
	L-6051G	Single Handle Lavatory Faucet Lever Handle	Chrome	12	\$151.00
	L-6051G-BN	4-3/4" Reach, 2-1/2" From Deck to Aerator Ceramic Disc Cartridge 1-Hole Installation Brass Grid Strainer Drain Assembly Easy-Install 18" Flex Supply Lines With 3/8" Connections With 1.2 GPM Flow Rate	PVD Brushed Nickel	12	\$204.00
	L-6051G-WD	1 or 3 Hole 4" Installation Deck Cover Plate Included	Chrome	12	\$159.00
	L-6051G-WD-BN		PVD Brushed Nickel	12	\$211.50
	L-6052	Single Handle Lavatory Faucet Lever Handle	Chrome	12	\$152.00
	L-6052-BN	4-3/4" Reach, 2-1/2" From Deck to Aerator Ceramic Disc Cartridge	PVD Brushed Nickel	12	\$202.50
	L-6052B*	1-Hole Installation	Chrome	12	\$150.00
	L-6052B-BN*	Brass Pop-Up Drain Assembly Easy-Install 18" Flex Supply Lines With 3/8" Connections With 1.2 GPM Flow Rate  *Builder Tract Pack	PVD Brushed Nickel	12	\$200.50
	L-6052-WD	1 or 3 Hole 4" Installation Deck Cover Plate Included	Chrome	12	\$160.00
	L-6052-WD-BN		PVD Brushed Nickel	12	\$216.00

Builder Tract Packs sold in case quantities only.  
Low flow aerators available upon request.

Olympia faucets feature aerators that meet ANSI/ASME A112.18.1 flow requirements of 1.5 GPM

LAVATORY





# LAVATORY // Single Handle Faucets

## SINGLE HANDLE LAVATORY FAUCETS

	Model#	Description	Finish	Case	Price
<b>PARTS</b>	OP-130001	Lever Handle	Chrome	---	\$14.00
	OP-390003	Ceramic Disc Cartridge	---	---	\$13.00
	OP-430021	Cap	Chrome	---	\$6.40
	OP-430022	Locknut	---	---	\$3.20
	OP-430023	Hole Cover	Chrome	---	\$1.00
	OP-430024	Aerator	Chrome	---	\$5.70
	OP-430025	Washer	---	---	\$0.70
	OP-430026	Deck Plate	Chrome	---	\$16.75
	OP-490029	3/32" Allen Screw	---	---	\$0.70
	OP-530005	Mounting Kit	---	---	\$5.00
	OP-630005	50/50 Pop-Up Drain Assembly	Chrome	---	\$26.00
	OP-630006	Brass Pop-Up Drain Assembly	Chrome	---	\$29.00

# LAVATORY // Single Handle Faucets

## SINGLE HANDLE LAVATORY FAUCETS



	Model#	Description	Finish	Case	Price
	L-6160	Single Handle Lavatory Faucet Metal Lever Handle	Chrome	12	\$75.00
	L-6160-BN	3-7/8" Reach, 1-3/4" From Deck to Aerator Stainless Steel Ball Operation	PVD Brushed Nickel	12	\$95.00
	L-6160-ORB	3-Hole 4" Installation	Oil Rubbed Bronze	12	\$106.50
	L-6160B*	With 1.2 GPM Flow Rate 50/50 Pop-Up Drain Assembly	Chrome	12	\$73.00
	L-6160B-BN*	*Builder Tract Pack	PVD Brushed Nickel	12	\$93.00
	L-6160H**	**Easy-Install 18" Flex Supply Lines With 3/8"	Chrome	12	\$76.00
	L-6160H-BN**	Connections	Chrome	12	\$100.00
	L-6161	Single Handle Lavatory Faucet Metal Lever Handle	Chrome	12	\$66.00
	L-6161H*	3-7/8" Reach, 1-3/4" From Deck to Aerator Stainless Steel Ball Operation	Chrome	12	\$67.00
	L-6164**	3-Hole 4" Installation With 1.2 GPM Flow Rate  *Easy-Install 18" Flex Supply Lines With 3/8" Connections **With Pop-Up Hole Cover	Chrome	12	\$65.00
	L-6161G	Single Handle Lavatory Faucet Metal Lever Handle 3-7/8" Reach, 1-3/4" From Deck to Aerator Stainless Steel Ball Operation 3-Hole 4" Installation With 1.2 GPM Flow Rate Brass Grid Strainer Drain Assembly	Chrome	12	\$81.00
	L-6162	Single Handle Lavatory Faucet Metal Lever Handle	Chrome	12	\$80.00
	L-6162-BN	3-7/8" Reach, 1-3/4" From Deck to Aerator Stainless Steel Ball Operation	PVD Brushed Nickel	12	\$106.50
	L-6162B*	3-Hole 4" Installation	Chrome	12	\$78.00
	L-6162H**	With 1.2 GPM Flow Rate Brass Pop-Up Drain Assembly  *Builder Tract Pack **Easy-Install 18" Flex Supply Lines With 3/8" Connections	Chrome	12	\$81.00
	L-6170	Single Handle Lavatory Faucet Metal Loop Handle	Chrome	12	\$75.00
	L-6170B*	3-7/8" Reach, 1-3/4" From Deck to Aerator Stainless Steel Ball Operation 3-Hole 4" Installation With 1.2 GPM Flow Rate 50/50 Pop-Up Drain Assembly  *Builder Tract Pack	Chrome	12	\$73.00

Builder Tract Packs sold in case quantities only.

Olympia faucets feature aerators that meet ANSI/ASME A112.18.1 flow requirements of 1.5 GPM

# LAVATORY // Single Handle Faucets

















## SINGLE HANDLE LAVATORY FAUCETS

	Model#	Description	Finish	Case	Price
	L-6174	Single Handle Lavatory Faucet Metal Loop Handle 3-7/8" Reach, 1-3/4" From Deck to Aerator Stainless Steel Ball Operation 3-Hole 4" Installation With 1.2 GPM Flow Rate With Pop-up Hole Cover	Chrome	12	\$65.00
	L-6172	Single Handle Lavatory Faucet Metal Loop Handle 3-7/8" Reach, 1-3/4" From Deck to Aerator Stainless Steel Ball Operation 3-Hole 4" Installation With 1.2 GPM Flow Rate Brass Pop-Up Drain Assembly	Chrome	12	\$80.00
	L-6172-BN	Single Handle Lavatory Faucet Metal Loop Handle 3-7/8" Reach, 1-3/4" From Deck to Aerator Stainless Steel Ball Operation 3-Hole 4" Installation With 1.2 GPM Flow Rate Brass Pop-Up Drain Assembly	PVD Brushed Nickel	12	\$106.50
<b>PARTS</b>	OP-190001	Metal Lever Handle	Chrome	---	\$13.30
	OP-190002	Metal Loop Handle	Chrome	---	\$13.30
	OP-390001	Stainless Steel Ball	---	---	\$3.50
	OP-430010	Lift Rod Hole Cover Button	Chrome	---	\$1.10
	OP-490002	Lever Handle Index Button	---	---	\$0.70
	OP-490003	Cap and Adjusting Ring	Chrome	---	\$7.00
	OP-490004	Cam and Washer	---	---	\$4.60
	OP-490041	Springs and Seats	---	---	\$1.20
	OP-490043	Lever Handle Allen Screw 1/8"	---	---	\$0.70
	OP-530001	Mounting Hardware	---	---	\$3.00
	OP-590001	Brass Supply Nut	---	---	\$1.20
	OP-630001	Brass Grid Strainer Drain Assembly	Chrome	---	\$27.60
	OP-630002	Brass Pop-Up Drain Assembly	Chrome	---	\$27.10
	OP-630004	50/50 Pop-Up Drain Assembly	Chrome	---	\$22.00
	OP-490035	Aerator-1.5 GPM	Chrome	---	\$6.90
	OP-490056	Aerator-1.0 GPM	Chrome	---	\$9.90
	OP-490055	Aerator-0.5 GPM	Chrome	---	\$8.80

Olympia faucets feature aerators that meet ANSI/ASME A112.18.1 flow requirements of 1.5 GPM

# LAVATORY // Two Handle Faucets

## TWO HANDLE LAVATORY FAUCETS

		Model#	Description	Finish	Case	Price
	  	L-7470	Two Handle Lavatory Faucet Lever Handles	Chrome	6	\$205.00
		L-7470-BN	J Style Rigid Spout 4-3/4" Reach, 3-11/16" From Deck to Aerator	PVD Brushed Nickel	6	\$240.00
		L-7470-ORB	Ceramic Disc Cartridges 3-Hole 4" to 16" Installation 50/50 Pop-Up Drain Assembly With 1.2 GPM Flow Rate	Oil Rubbed Bronze	6	\$245.00
	  	L-7472	Two Handle Lavatory Faucet Lever Handles	Chrome	6	\$210.00
		L-7472-BN	J Style Rigid Spout 4-3/4" Reach, 3-11/16" From Deck to Aerator	PVD Brushed Nickel	6	\$245.00
		L-7472-ORB	Ceramic Disc Cartridges 3-Hole 4" to 16" Installation Brass Pop-Up Drain Assembly With 1.2 GPM Flow Rate	Oil Rubbed Bronze	6	\$253.00
	  	L-7570	Two Handle Lavatory Faucet Lever Handles	Chrome	12	\$135.00
		L-7570-BN	J Style Rigid Spout 4-1/16" Reach, 3-11/16" From Deck to Aerator	PVD Brushed Nickel	12	\$164.70
		L-7570-ORB	Ceramic Disc Cartridges 3-Hole 4" Installation	Oil Rubbed Bronze	12	\$173.00
		L-7570B*	50/50 Pop-Up Drain Assembly With 1.2 GPM Flow Rate	Chrome	12	\$133.00
		L-7570B-BN*	*Builder Tract Pack	PVD Brushed Nickel	12	\$162.70
	  	L-7572	Two Handle Lavatory Faucet Lever Handles	Chrome	12	\$140.00
		L-7572-BN	J Style Rigid Spout 4-1/16" Reach, 3-11/16" From Deck to Aerator	PVD Brushed Nickel	12	\$170.80
		L-7572-ORB	Ceramic Disc Cartridges 3-Hole 4" Installation	Oil Rubbed Bronze	12	\$179.40
		L-7572B*	Brass Pop-Up Drain Assembly With 1.2 GPM Flow Rate  *Builder Tract Pack	Chrome	12	\$138.00

Builder Tract Packs sold in case quantities only.  
Low flow aerators available upon request.

Olympia faucets feature aerators that meet ANSI/ASME A112.18.1 flow requirements of 1.5 GPM

LAVATORY

# LAVATORY // Two Handle Faucets







## TWO HANDLE LAVATORY FAUCETS

	Model#	Description	Finish	Case	Price
PARTS	OP-490011	3/32" Allen Wrench		---	\$0.70
	OP-190015C	Lever Handle-Cold	---	---	\$14.30
	OP-190015H	Lever Handle-Hot	---	---	\$14.30
	OP-430027	Valve Escutcheon	Polish Chrome Finish	---	\$11.40
	OP-330002C	Ceramic Stem - Cold	---	---	\$8.00
	OP-330002H	Ceramic Stem - Hot	---	---	\$8.00
	OP-590002	Valve Mounting Hardware	---	---	\$5.90
	OP-590001	Brass Supply Nut	---	---	\$1.20
	OP-490009	Y Connector Set	---	---	\$20.40
	OP-430001	Spout Mounting Hardware	---	---	\$3.50
	OP-230005	J Style Spout	Polished Chrome Finish	---	\$145.00
	OP-630004	50/50 Pop-Up Drain Assembly	---	---	\$22.00
	OP-490029	Handle 3/32" Allen Screw	---	---	\$0.70
	OP-490010	Aerator-1.5 GPM	---	---	\$5.70
	OP-430028	Gasket	---	---	\$0.70
	OP-630002	Brass Pop-Up Drain Assembly	---	---	\$27.10
	OP-450002	Bonnet Nut	---	---	\$2.40
	OP-430029	Bonnet Nut Gasket	---	---	\$0.70
	OP-450005	Mounting Gasket	---	---	\$1.80
	OP-590003	Mounting Hardware	---	---	\$2.40

Olympia faucets feature aerators that meet ANSI/ASME A112.18.1 flow requirements of 1.5 GPM

# LAVATORY // Two Handle Faucets

## TWO HANDLE LAVATORY FAUCETS

	Model#	Description	Finish	Case	Price
	L-7220	Two Handle Lavatory Faucet Acrylic Round Handles 3-5/8" Reach, 1-1/2" From Deck to Aerator Washerless Cartridge Operation 3-Hole 4" Installation With 1.2 GPM Flow Rate 50/50 Pop-Up Drain Assembly	Chrome	12	\$56.50
	L-7221	Two Handle Lavatory Faucet Acrylic Round Handles 3-5/8" Reach, 1-1/2" From Deck to Aerator Washerless Cartridge Operation 3-Hole 4" Installation With 1.2 GPM Flow Rate	Chrome	12	\$46.50
	L-7222	Two Handle Lavatory Faucet Acrylic Round Handles 3-5/8" Reach, 1-1/2" From Deck to Aerator Washerless Cartridge Operation 3-Hole 4" Installation With 1.2 GPM Flow Rate Brass Pop-Up Drain Assembly	Chrome	12	\$66.50
	L-7290	Two Handle Lavatory Faucet Mini Blade Handles 3-5/8" Reach, 1-1/2" From Deck to Aerator Washerless Cartridge Operation 3-Hole 4" Installation With 1.2 GPM Flow Rate 50/50 Pop-Up Drain Assembly	Chrome	12	\$60.00
	L-7291	Two Handle Lavatory Faucet Mini Blade Handles 3-5/8" Reach, 1-1/2" From Deck to Aerator Washerless Cartridge Operation 3-Hole 4" Installation With 1.2 GPM Flow Rate	Chrome	12	\$50.00
	L-7292	Two Handle Lavatory Faucet Mini Blade Handles 3-5/8" Reach, 1-1/2" From Deck to Aerator Washerless Cartridge Operation 3-Hole 4" Installation With 1.2 GPM Flow Rate Brass Pop-Up Drain Assembly	Chrome	12	\$69.00



Builder Tract Packs sold in case quantities only.

Olympia faucets feature aerators that meet ANSI/ASME A112.18.1 flow requirements of 1.5 GPM

LAVATORY

# LAVATORY // Two Handle Faucets

## TWO HANDLE LAVATORY FAUCETS

	Model#	Description	Finish	Case	Price
	L-7251	Two Handle Lavatory Faucet ADA Wrist Blade Handles 3-5/8" Reach, 1-1/2" From Deck to Aerator Washerless Cartridge Operation 3-Hole 4" Installation With 1.2 GPM Flow Rate	Chrome	12	\$62.50
	L-7251G	Two Handle Lavatory Faucet ADA Wrist Blade Handles 3-5/8" Reach, 1-1/2" From Deck to Aerator Washerless Cartridge Operation 3-Hole 4" Installation With 1.2 GPM Flow Rate Brass Grid Strainer Drain Assembly	Chrome	12	\$77.50
<b>PARTS</b>	OP-190003C	Acrylic Round Handle-Cold	---	---	\$3.50
	OP-190003H	Acrylic Round Handle-Hot	---	---	\$3.50
	OP-190004C	Mini Blade Handle-Cold	Chrome	---	\$4.10
	OP-190004H	Mini Blade Handle-Hot	Chrome	---	\$4.10
	OP-190005C	ADA Wrist Blade Square Handle Set-Cold	Chrome	---	\$9.80
	OP-190005H	ADA Wrist Blade Square Handle Set-Hot	Chrome	---	\$9.80
	OP-390004	Stem Unit-Brass Post	---	---	\$4.60
	OP-390005	Stem Unit-Plastic Post	---	---	\$4.60
	OP-430005	Lift Rod Hole Cover Button	Chrome	---	\$0.70
	OP-490012C	Acrylic Handle Button-Cold	---	---	\$1.20
	OP-490012H	Acrylic Handle Button-Hot	---	---	\$1.20
	OP-490013C	Mini Blade Handle Button-Cold	---	---	\$1.20
	OP-490013H	Mini Blade Handle Button-Hot	---	---	\$1.20
	OP-490014	Handle Screw	---	---	\$0.70
	OP-490015	ADA Wrist Blade Square Handle Screw	---	---	\$0.70
	OP-490016C	ADA Wrist Blade Square Handle Index-Cold	---	---	\$0.70
	OP-490016H	ADA Wrist Blade Square Handle Index-Hot	---	---	\$0.70

Olympia faucets feature aerators that meet ANSI/ASME A112.18.1 flow requirements of 1.5 GPM

# LAVATORY // Two Handle Faucets







## TWO HANDLE LAVATORY FAUCETS

	Model#	Description	Finish	Case	Price
	OP-490040	Bonnet Nut	---	---	\$2.40
	OP-490041	Springs and Seats	---	---	\$1.20
	OP-590001	Brass Supply Nut	---	---	\$1.20
	OP-590003	Mounting Hardware	---	---	\$2.40
	OP-630001	Brass Grid Strainer Drain Assembly	Chrome	---	\$27.60
	OP-630002	Brass Pop-Up Drain Assembly	Chrome	---	\$27.10
	OP-630004	50/50 Pop-Up Drain Assembly	Chrome	---	\$22.00
	OP-490035	Aerator-1.5 GPM	Chrome	---	\$6.90
	OP-490056	Aerator-1.0 GPM	Chrome	---	\$9.90
	OP-490055	Aerator-0.5 GPM	Chrome	---	\$8.80

Olympia faucets feature aerators that meet ANSI/ASME A112.18.1 flow requirements of 1.5 GPM

# LAVATORY // Two Handle Faucets

## TWO HANDLE LAVATORY FAUCETS

	Model#	Description	Finish	Case	Price
	L-7240	Two Handle Lavatory Faucet Lever Handles	Chrome	12	\$74.00
	L-7240-BN	4-1/8" Reach, 1-3/4" From Deck to Aerator Washerless Cartridge Operation	PVD Brushed Nickel	12	\$94.00
	L-7240-ORB	3-Hole 4" Installation	Oil Rubbed Bronze	12	\$105.00
	L-7240B*	With 1.2 GPM Flow Rate 50/50 Pop-Up Drain Assembly	Chrome	12	\$72.00
	L-7240B-BN*	*Builder Tract Pack	PVD Brushed Nickel	12	\$92.00
	L-7241	Two Handle Lavatory Faucet Lever Handles	Chrome	12	\$64.00
	L-7241-BN	4-1/8" Reach, 1-3/4" From Deck to Aerator Washerless Cartridge Operation 3-Hole 4" Installation With 1.2 GPM Flow Rate	PVD Brushed Nickel	12	\$77.50
	L-7242	Two Handle Lavatory Faucet Lever Handles	Chrome	12	\$82.00
	L-7242-BN	4-1/8" Reach, 1-3/4" From Deck to Aerator Washerless Cartridge Operation	PVD Brushed Nickel	12	\$104.00
	L-7242-ORB	3-Hole 4" Installation	Oil Rubbed Bronze	12	\$114.50
	L-7242-MZ	With 1.2 GPM Flow Rate Brass Pop-Up Drain Assembly	Moroccan Bronze	12	\$120.50
	L-7242B*	*Builder Tract Pack	Chrome	12	\$80.00
	L-7270	Two Handle Lavatory Faucet Lever Handles	Chrome	12	\$79.00
	L-7270-BN	4-1/8" Reach, 1-3/4" From Deck to Aerator Washerless Cartridge Operation 3-Hole 4" Installation With 1.2 GPM Flow Rate 50/50 Pop-Up Drain Assembly	PVD Brushed Nickel	12	\$99.00
	L-7271	Two Handle Lavatory Faucet Lever Handles 4-1/8" Reach, 1-3/4" From Deck to Aerator Washerless Cartridge Operation 3-Hole 4" Installation With 1.2 GPM Flow Rate	Chrome	12	\$69.00
	L-7272	Two Handle Lavatory Faucet Lever Handles	Chrome	12	\$84.00
	L-7272-BN	4-1/8" Reach, 1-3/4" From Deck to Aerator Washerless Cartridge Operation	PVD Brushed Nickel	12	\$107.50
	L-7272B*	3-Hole 4" Installation With 1.2 GPM Flow Rate Brass Pop-Up Drain Assembly  *Builder Tract Pack	Chrome	12	\$82.00

Builder Tract Packs sold in case quantities only.

Olympia faucets feature aerators that meet ANSI/ASME A112.18.1 flow requirements of 1.5 GPM















# LAVATORY // Two Handle Faucets

## TWO HANDLE LAVATORY FAUCETS

	Model#	Description	Finish	Case	Price
<b>PARTS</b>	OP-190010C	Lever Handle-Cold	Chrome	---	\$13.30
	OP-190010H	Lever Handle-Hot	Chrome	---	\$13.30
	OP-190015C	Lever Handle-Cold	Chrome	---	\$14.30
	OP-190015H	Lever Handle-Hot	Chrome	---	\$14.30
	OP-390004	Stem Unit-Brass Post	---	---	\$4.60
	OP-430005	Lift Rod Hole Cover Button	Chrome	---	\$0.70
	OP-490029	Handle Set Screw	---	---	\$0.70
	OP-490040	Bonnet Nut	---	---	\$2.40
	OP-490041	Springs and Seats	---	---	\$1.20
	OP-590001	Brass Supply Nut	---	---	\$1.20
	OP-590003	Mounting Hardware	---	---	\$2.40
	OP-630002	Brass Pop-Up Drain Assembly	Chrome	---	\$27.10
	OP-630004	50/50 Pop-Up Drain Assembly	Chrome	---	\$22.00
	OP-430007	Aerator-1.5 GPM	Chrome	---	\$7.50
	OP-430012	Aerator-1.0 GPM	Chrome	---	\$10.50
	OP-430011	Aerator-0.5 GPM	Chrome	---	\$8.80

# LAVATORY // Two Handle Faucets

## TWO HANDLE LAVATORY FAUCETS













		Model#	Description	Finish	Case	Price
	   	L-7330	Two Handle Lavatory Widespread Faucet Lever Handles	Chrome	6	\$156.00
		L-7330-BN	C Style Rigid Spout 4-9/16" Reach, 1-7/8" From Deck to Aerator	PVD Brushed Nickel	6	\$199.00
		L-7330-ORB	Washerless Cartridge Operation 3-Hole 4" to 16" Installation With 1.2 GPM Flow Rate 50/50 Pop-Up Drain Assembly	Oil Rubbed Bronze	6	\$223.00
	   	L-7332	Two Handle Lavatory Widespread Faucet Lever Handles	Chrome	6	\$161.00
		L-7332-BN	C Style Rigid Spout 4-9/16" Reach, 1-7/8" From Deck to Aerator	PVD Brushed Nickel	6	\$208.00
		L-7332-ORB	Washerless Cartridge Operation 3-Hole 4" to 16" Installation With 1.2 GPM Flow Rate Brass Pop-Up Drain Assembly	Oil Rubbed Bronze	6	\$233.00
	   	L-7372	Two Handle Lavatory Widespread Faucet Lever Handles	Chrome	6	\$166.00
		L-7372-BN	C Style Rigid Spout 4-9/16" Reach, 1-7/8" From Deck to Aerator	PVD Brushed Nickel	6	\$213.00
		L-7372-ORB	Washerless Cartridge Operation 3-Hole 4" to 16" Installation With 1.2 GPM Flow Rate Brass Pop-Up Drain Assembly	Oil Rubbed Bronze	6	\$238.50
<b>PARTS</b>		OP-190010C	Lever Handle-Cold	Chrome	---	\$13.30
		OP-190010H	Lever Handle-Hot	Chrome	---	\$13.30
		OP-190015C	Lever Handle-Cold	Chrome	---	\$14.30
		OP-190015H	Lever Handle-Hot	Chrome	---	\$14.30
		OP-230001	C Style Spout	Chrome	---	\$115.30
		OP-390004	Stem Unit-Brass Post	---	---	\$4.60
		OP-430001	Spout Mounting Hardware	---	---	\$3.50
		OP-490006	Bonnet Nut	---	---	\$5.30
		OP-490007	Valve Escutcheon	Chrome	---	\$11.40
		OP-490009	Y Connector Set	---	---	\$20.40
		OP-490030	Extension Kit	---	---	\$44.50
		OP-490041	Springs and Seats	---	---	\$1.20
		OP-590002	Valve Mounting Hardware	---	---	\$5.90
		OP-630002	Brass Pop-Up Drain Assembly	Chrome	---	\$27.10
		OP-630004	50/50 Pop-Up Drain Assembly	Chrome	---	\$22.00
		OP-490010	Aerator-1.5 GPM	Chrome	---	\$5.70
		OP-490058	Aerator-1.0 GPM	Chrome	---	\$8.80

Olympia faucets feature aerators that meet ANSI/ASME A112.18.1 flow requirements of 1.5 GPM

# TUB & SHOWER // Pressure Balance Trim Sets

## NEW FAUCETS

### PRESSURE BALANCE TRIM SETS

	Model#	Description	Finish	Case	Price
	 	<b>P-2390T</b> Single Handle Tub/Shower Trim Set Lever Handle	Chrome	12	\$100.00
		<b>P-2390T-BN</b> Face Plate Single Function 3-3/4" Showerhead, Arm & Flange Combo 1/2" IPS/Slip-On Diverter Tub Spout With Escutcheon With 1.75 GPM Flow Rate  For Use with P-2300B & P-2400B Series Valves - Valve not included	PVD Brushed Nickel	12	\$150.00
		<b>P-2391T</b> Single Handle Tub Trim Set Lever Handle	Chrome	12	\$90.00
		<b>P-2391T-BN</b> Face Plate Combo 1/2" IPS/Slip-On Tub Spout With Escutcheon  For Use with P-2300B & P-2400B Series Valves - Valve not included	PVD Brushed Nickel	12	\$135.00
		<b>P-2392T</b> Single Handle Shower Trim Set Lever Handle	Chrome	12	\$90.00
		<b>P-2392T-BN</b> Face Plate Single Function 3-3/4" Showerhead, Arm & Flange With 1.75 GPM Flow Rate  For Use with P-2300B & P-2400B Series Valves - Valve not included	PVD Brushed Nickel	12	\$135.00
	 	<b>P-2394T</b> Single Handle Tub/Shower Trim Set Lever Handle	Chrome	12	\$110.00
		<b>P-2394T-BN</b> Face Plate Single Function 4" Square Showerhead, Arm & Flange Combo 1/2" IPS/Slip-On Diverter Tub Spout with Escutcheon With 1.75 GPM Flow Rate  For Use with P-2300B & P-2400B Series Valves - Valve not included	PVD Brushed Nickel	12	\$165.00
	 	<b>P-2395T</b> Single Handle Shower Trim Set Lever Handle	Chrome	12	\$100.00
		<b>P-2395T-BN</b> Face Plate Single Function 4" Square Showerhead, Arm & Flange With 1.75 GPM Flow Rate  For Use with P-2300B & P-2400B Series Valves - Valve not included	PVD Brushed Nickel	12	\$150.00
	 	<b>P-2394T-6</b> Single Handle Tub/Shower Trim Set Lever Handle	Chrome	12	\$123.00
		<b>P-2394T-6-BN</b> Face Plate Single Function 6" Square Showerhead, Arm & Flange Combo 1/2" IPS/Slip-On Diverter Tub Spout with Escutcheon With 1.75 GPM Flow Rate  For Use with P-2300B & P-2400B Series Valves - Valve not included	PVD Brushed Nickel	12	\$184.50
	 	<b>P-2395T-6</b> Single Handle Shower Trim Set Lever Handle	Chrome	12	\$115.60
		<b>P-2395T-6-BN</b> Face Plate Single Function 6" Square Showerhead, Arm & Flange With 1.75 GPM Flow Rate  For Use with P-2300B & P-2400B Series Valves - Valve not included	PVD Brushed Nickel	12	\$173.40





TUB & SHOWER

Olympia showerheads meet ANSI/ASME A112.18.1 flow requirements of maximum 1.75 GPM

# TUB & SHOWER // Pressure Balance Trim Sets

## NEW FAUCETS

### PRESSURE BALANCE TRIM SETS







	Model#	Description	Finish	Case	Price
	P-2396T	Single Handle Tub/Shower Trim Set Lever Handle	Chrome	12	\$140.00
	P-2396T-BN	Face Plate Single Function 3-3/4" Showerhead, Arm & Flange Extended Combo 1/2" IPS/Slip-On Diverter Tub Spout With Escutcheon With 1.75 GPM Flow Rate  For Use with P-2300B & P-2400B Series Valves - Valve not included	PVD Brushed Nickel	12	\$210.00
	P-2397T	Single Handle Tub Trim Set Lever Handle	Chrome	12	\$120.00
	P-2397T-BN	Face Plate Extended Combo 1/2" IPS/Slip-On Tub Spout With Escutcheon  For Use with P-2300B & P-2400B Series Valves - Valve not included	PVD Brushed Nickel	12	\$180.00
	P-2398T	Single Handle Tub/Shower Trim Set Lever Handle	Chrome	12	\$155.00
	P-2398T-BN	Face Plate	PVD Brushed Nickel	12	\$232.50
	P-2398T-6*	Single Function 4" Square Showerhead, Arm & Flange Extended Combo 1/2" IPS/Slip-On Diverter Tub Spout With Escutcheon	Chrome	12	\$168.00
	P-2398T-6-BN*	With 1.75 GPM Flow Rate  For Use with P-2300B & P-2400B Series Valves - Valve not included  * With Single Function 6" Square Showerhead	PVD Brushed Nickel	12	\$252.00
	P-2393T	Single Handle Valve Trim Set Lever Handle	Chrome	12	\$68.00
	P-2393T-BN	Face Plate  For Use with P-2300B & P-2400B Series Valves - Valve not included	PVD Brushed Nickel	12	\$102.00
	P-2290	Single Handle Diverter Set Lever Handle	Chrome	12	\$115.00
	P-2290-BN	Three Way Diverter Valve Diverter Valve Face Plate Ceramic Disc Cartridge Diverter Valve Sleeve Combo CXC and IPS Connections	PVD Brushed Nickel	12	\$145.00

Olympia showerheads meet ANSI/ASME A112.18.1 flow requirements of maximum 1.75 GPM

# TUB & SHOWER // Pressure Balance Trim Sets

## NEW FAUCETS

### PRESSURE BALANCE TRIM SETS

	Model#	Description	Finish	Case	Price
	 	<b>P-2380T</b> Single Handle Tub/Shower Trim Set Lever Handle	Chrome	12	\$95.00
	<b>P-2380T-BN</b> Face Plate Single Function 3-3/4" Showerhead, Arm & Flange Combo 1/2" IPS/Slip-On Diverter Tub Spout With Escutcheon With 1.75 GPM Flow Rate  For Use with P-2300B & P-2400B Series Valves - Valve not included	PVD Brushed Nickel	12	\$142.50	
	<b>P-2381T</b> Single Handle Tub Trim Set Lever Handle	Chrome	12	\$85.00	
	<b>P-2381T-BN</b> Face Plate Combo 1/2" IPS/Slip-On Tub Spout With Escutcheon  For Use with P-2300B & P-2400B Series Valves - Valve not included	PVD Brushed Nickel	12	\$127.50	
	<b>P-2382T</b> Single Handle Shower Trim Set Lever Handle	Chrome	12	\$85.00	
	<b>P-2382T-BN</b> Face Plate Single Function 3-3/4" Showerhead, Arm & Flange With 1.75 GPM Flow Rate  For Use with P-2300B & P-2400B Series Valves - Valve not included	PVD Brushed Nickel	12	\$127.50	
	 	<b>P-2384T</b> Single Handle Tub/Shower Trim Set Lever Handle	Chrome	12	\$138.50
	<b>P-2384T-BN</b> Face Plate Single Function Rain Showerhead, Arm & Flange Extended Combo 1/2" IPS/Slip-On Diverter Tub Spout with Escutcheon With 1.75 GPM Flow Rate  For Use with P-2300B & P-2400B Series Valves - Valve not included	PVD Brushed Nickel	12	\$207.75	
	<b>P-2385T</b> Single Handle Shower Trim Set Lever Handle	Chrome	12	\$123.50	
	<b>P-2385T-BN</b> Face Plate Single Function Rain Showerhead, Arm & Flange With 1.75 GPM Flow Rate  For Use with P-2300B & P-2400B Series Valves - Valve not included	PVD Brushed Nickel	12	\$185.25	



Olympia showerheads meet ANSI/ASME A112.18.1 flow requirements of maximum 1.75 GPM

TUB & SHOWER

# TUB & SHOWER // Pressure Balance Trim Sets

## NEW FAUCETS





### PRESSURE BALANCE TRIM SETS

	Model#	Description	Finish	Case	Price
	P-2386T	Single Handle Tub/Shower Trim Set Lever Handle	Chrome	12	\$106.00
	P-2386T-BN	Face Plate Three Function 4-5/8" Showerhead, Arm & Flange Combo 1/2" IPS/Slip-On Diverter Tub Spout With Escutcheon With 1.75 GPM Flow Rate  For Use with P-2300B & P-2400B Series Valves - Valve not included	PVD Brushed Nickel	12	\$159.00
	P-2387T	Single Handle Shower Trim Set Lever Handle	Chrome	12	\$96.00
	P-2387T-BN	Face Plate Three Function 4-5/8" Showerhead, Arm & Flange With 1.75 GPM Flow Rate  For Use with P-2300B & P-2400B Series Valves - Valve not included	PVD Brushed Nickel	12	\$144.00
	P-2383T	Single Handle Valve Trim Set Lever Handle	Chrome	12	\$65.00
	P-2383T-BN	Face Plate  For Use with P-2300B & P-2400B Series Valves - Valve not included	PVD Brushed Nickel	12	\$97.50
	P-2280	Single Handle Diverter Set Lever Handle	Chrome	12	\$108.00
	P-2280-BN	Three Way Diverter Valve Diverter Valve Face Plate Ceramic Disc Cartridge Diverter Valve Sleeve Combo CXC and IPS Connections	PVD Brushed Nickel	12	\$135.00

Olympia showerheads meet ANSI/ASME A112.18.1 flow requirements of maximum 1.75 GPM

# TUB & SHOWER // Pressure Balance Trim Sets

## PRESSURE BALANCE TRIM SETS

	Model#	Description	Finish	Case	Price
	P-2370T	Single Handle Tub/Shower Trim Set Lever Handle	Chrome	12	\$95.00
	P-2370T-BN	Face Plate Single Function 3-3/4" Showerhead, Arm & Flange Combo 1/2" IPS/Slip-On Diverter Tub Spout With Escutcheon With 1.75 GPM Flow Rate For Use with P-2300B & P-2400B Series Valves - Valve not included	PVD Brushed Nickel	12	\$142.50
	P-2371T	Single Handle Tub Trim Set Lever Handle	Chrome	12	\$85.00
	P-2371T-BN	Face Plate Combo 1/2" IPS/Slip-On Diverter Tub Spout With Escutcheon For Use with P-2300B & P-2400B Series Valves - Valve not included	PVD Brushed Nickel	12	\$127.50
	P-2372T	Single Handle Shower Trim Set Lever Handle	Chrome	12	\$85.00
	P-2372T-BN	Face Plate Single Function 3-3/4" Showerhead, Arm & Flange With 1.75 GPM Flow Rate  For Use with P-2300B & P-2400B Series Valves - Valve not included	PVD Brushed Nickel	12	\$127.50
	P-2374T	Single Handle Tub/Shower Trim Set Lever Handle	Chrome	12	\$138.50
	P-2374T-BN	Face Plate Single Function Rain Showerhead, Arm & Flange Extended Combo 1/2" IPS/Slip-On Diverter Tub Spout with Escutcheon With 1.75 GPM Flow Rate  For Use with P-2300B & P-2400B Series Valves - Valve not included	PVD Brushed Nickel	12	\$207.75
	P-2375T	Single Handle Shower Trim Set Lever Handle	Chrome	12	\$123.50
	P-2375T-BN	Face Plate Single Function Rain Showerhead, Arm & Flange With 1.75 GPM Flow Rate  For Use with P-2300B & P-2400B Series Valves - Valve not included	PVD Brushed Nickel	12	\$185.25
	P-2373T	Single Handle Valve Trim Set Lever Handle	Chrome	12	\$65.00
	P-2373T-BN	Face Plate  For Use with P-2300B & P-2400B Series Valves - Valve not included	PVD Brushed Nickel	12	\$97.50
	P-2270	Single Handle Diverter Set Lever Handle	Chrome	12	\$108.00
	P-2270-BN	Three Way Diverter Valve Diverter Valve Face Plate Ceramic Disc Cartridge Diverter Valve Sleeve Combo CXC and IPS Connections	PVD Brushed Nickel	12	\$135.00

Olympia showerheads meet ANSI/ASME A112.18.1 flow requirements of maximum 1.75 GPM

# TUB & SHOWER // Pressure Balance Trim Sets



## PRESSURE BALANCE TRIM SETS

	Model#	Description	Finish	Case	Price
<b>PARTS</b>	OP-140011	Lever Handle (For P-2370T Series)	Chrome	---	\$22.00
	OP-160003	Lever Handle (For P-2270)	Chrome	---	\$21.00
	OP-160004	Lever Handle for (P-2280)	Chrome	---	\$24.00
	OP-160005	Lever Handle for (P-2290)	Chrome	---	\$26.00
	OP-440010	Face Plate Screw	Chrome	---	\$3.00
	OP-440051	Face Plate	Chrome	---	\$21.00
	OP-490011	3/32" Allen Wrench	---	---	\$0.70
	OP-640001	Shower Arm Flange	Chrome	---	\$1.20
	OP-640002	Shower Arm	Chrome	---	\$11.00
	OP-640007	Diverter Tub Spout	Chrome	---	\$20.50
	OP-640008	Escutcheon	Chrome	---	\$9.00
	OP-640019	Non Diverter Tub Spout	Chrome	---	\$13.30
	OP-640038	Single Function Showerhead-1.75 GPM	Chrome	---	\$30.00
	OP-640039	Single Function Showerhead-1.5 GPM	Chrome	---	\$31.00
	OP-640040	Extended 7" Diverter Tub Spout	Chrome	---	\$55.00
	OP-640037	1.75 GPM Rain Shower Head (For P-2374T, P-2375T)	Chrome	---	\$53.00
	OP-640041	1.75 GPM Shower Head (For P-2386T, P-2387T)	Chrome	---	\$49.00
	OP-140018	Lever Handle (For P-2380T Series)	Chrome	---	\$24.00
	OP-440054	Sleeve	Chrome	---	\$6.00
	OP-440043	Allen Screw	---	---	\$1.00
	OP-640045	Shower Arm Flange (For P-2390T Series)	Chrome	---	\$8.00
	OP-640042	1.75 GPM 4" Square Shower Head (For P-2394T, P-2395T, P2398T)	Chrome	---	\$52.00
	X-6400088	1.75 GPM 6" Square Shower Head (For P-2394T-6, P-2395T-6, P2398T-6)	Chrome	---	\$49.50
	OP-440055	Tub Spout Escutcheon (For P-2390T Series)	Chrome	---	\$19.00
	OP-140019	Lever Handle (For P-2390T Series)	Chrome	---	\$26.00
	OP-640046	Diverter Tub Spout (For P-2390T Series)	Chrome	---	\$23.00
	OP-440056	Face Plate Set (For P-2390T Series)	Chrome	---	\$29.00
	OP-640043	7" Extended Diverter Tub Spout (For P-2396T, P-2398T)	Chrome	---	\$89.00
	OP-640044	7" Extended Non-Diverter Tub Spout (For P-2397T)	Chrome	---	\$89.00

Olympia showerheads meet ANSI/ASME A112.18.1 flow requirements of maximum 1.75 GPM

# TUB & SHOWER // Pressure Balance Trim Sets

## PRESSURE BALANCE TRIM SETS

	Model#	Description	Finish	Case	Price
	 P-2300T	Single Handle Tub/Shower Trim Set Metal Lever Handle	Chrome	12	\$60.50
	P-2300T-BN	Face Plate	PVD Brushed Nickel	12	\$93.00
	P-2300T-ORB	Single Function 2-1/4" Standard Showerhead, Arm & Flange	Oil Rubbed Bronze	12	\$107.00
	P-2300T-MZ	Combo 1/2" IPS/Slip-On Diverter Tub Spout With 1.75 GPM Flow Rate	Moroccan Bronze	12	\$112.50
	P-2310T*	For Use with P-2300B & P-2400B Series Valves - Valve not included *Metal Loop Handle	Chrome	12	\$63.00
	P-2301T	Single Handle Tub Trim Set Metal Lever Handle	Chrome	12	\$44.50
	P-2301T-BN	Face Plate	PVD Brushed Nickel	12	\$77.00
	P-2301T-ORB	Combo 1/2" IPS/Slip-On Tub Spout Series Valves - Valve not included For Use with P-2300B & P-2400B	Oil Rubbed Bronze	12	\$88.00
	P-2302T	Single Handle Shower Trim Set Metal Lever Handle	Chrome	12	\$44.50
	P-2302T-BN	Face Plate	PVD Brushed Nickel	12	\$77.00
	P-2302T-ORB	Single Function 2-1/4" Standard Showerhead, Arm & Flange	Oil Rubbed Bronze	12	\$88.00
	P-2312T*	With 1.75 GPM Flow Rate For Use with P-2300B & P-2400B Series Valves - Valve not included *Metal Loop Handle	Chrome	12	\$47.00
 P-2303T	Single Handle Valve Trim Set Metal Lever Handle Face Plate For Use with P-2300B & P-2400B Series Valves - Valve not included	Chrome	12	\$27.50	









Low flow showerheads available upon request.

Olympia showerheads meet ANSI/ASME A112.18.1 flow requirements of maximum 1.75 GPM

TUB & SHOWER

# TUB & SHOWER // Pressure Balance Trim Sets

## PRESSURE BALANCE TRIM SETS





	Model#	Description	Finish	Case	Price
	 P-2340T	Single Handle Tub/Shower Trim Set Lever Handle	Chrome	12	\$69.00
	 P-2340T-BN	Face Plate	PVD Brushed Nickel	12	\$117.50
	P-2340T-ORB	Three Function 2-1/2" Pulsating Showerhead, Arm & Flange	Oil Rubbed Bronze	12	\$135.00
	P-2340T-MZ	Combo 1/2" IPS/Slip-On Diverter Tub Spout With 1.75 GPM Flow Rate For Use with P-2300B & P-2400B Series Valves - Valve not included	Moroccan Bronze	12	\$142.00
	P-2342T	Single Handle Shower Trim Set Lever Handle	Chrome	12	\$53.00
	P-2342T-BN	Face Plate	PVD Brushed Nickel	12	\$94.00
	P-2342T-ORB	Three Function 2-1/2" Pulsating Showerhead, Arm & Flange	Oil Rubbed Bronze	12	\$108.00
	P-2342T-MZ	With 1.75 GPM Flow Rate For Use with P-2300B & P-2400B Series Valves - Valve not included	Moroccan Bronze	12	\$113.50
	 P-2350T	Single Handle Tub/Shower Trim Set Lever Handle	Chrome	12	\$86.50
	 P-2350T-BN	Face Plate	PVD Brushed Nickel	12	\$141.00
	P-2351T	Four Function 3-3/8" Showerhead, Arm & Flange Combo 1/2" IPS/Slip-On Diverter Tub Spout with Escutcheon With 1.75 GPM Flow Rate For Use with P-2300B & P-2400B Series Valves - Valve not included			
	P-2352T	Single Handle Tub Trim Set Lever Handle	Chrome	12	\$70.50
	P-2352T-BN	Face Plate Combo 1/2" IPS/Slip-On Tub Spout with Escutcheon For Use with P-2300B & P-2400B Series Valves - Valve not included	PVD Brushed Nickel	12	\$125.00
	 P-2343T	Single Handle Valve Trim Set Lever Handle	Chrome	12	\$37.00
	P-2343T-BN	Face Plate For Use with P-2300B & P-2400B Series Valves - Valve not included	PVD Brushed Nickel	12	\$63.00

Low flow showerheads available upon request.

Olympia showerheads meet ANSI/ASME A112.18.1 flow requirements of maximum 1.75 GPM

# TUB & SHOWER // Pressure Balance Trim Sets

## PRESSURE BALANCE TRIM SETS

	Model#	Description	Finish	Case	Price
	 <b>P-2360T</b>	Single Handle Tub/Shower Trim Set Lever Handle	Chrome	12	\$73.00
	<b>P-2360T-BN</b>	Face Plate Three Function 2-1/2" Pulsating Showerhead, Arm & Flange Combo 1/2" IPS/Slip-On Diverter Tub Spout With 1.75 GPM Flow Rate For Use with P-2300B & P-2400B Series Valves - Valve not included	PVD Brushed Nickel	12	\$120.00
	<b>P-2362T</b>	Single Handle Shower Trim Set Lever Handle	Chrome	12	\$57.00
	<b>P-2362T-BN</b>	Face Plate Three Function 2-1/2" Pulsating Showerhead, Arm & Flange For Use with P-2300B & P-2400B Series Valves - Valve not included	PVD Brushed Nickel	12	\$98.00
  <b>P-2363T</b>	Single Handle Valve Trim Set Lever Handle Face Plate For Use with P-2300B & P-2400B Series Valves - Valve not included	Chrome	12	\$41.00	





Low flow showerheads available upon request.

Olympia showerheads meet ANSI/ASME A112.18.1 flow requirements of maximum 1.75 GPM

# TUB & SHOWER // Pressure Balance Trim Sets

## NEW FAUCETS

### PRESSURE BALANCE TRIM SETS

	Model#	Description	Finish	Case	Price
	 P-2300T-ADA	Single Handle Tub/Shower Trim Set with Diverter and Handheld Showerhead Single Function 2-1/4" Standard Showerhead-1.75 GPM Shower Arm & Flange Brass Diverter Valve Assembly - Diverter Valve Included Metal Lever Handles Face Plate For Use with P-2300B & P-2400B Series Valves - Valve not included Combo 1/2" IPS/Slip-On Diverter Tub Spout  Five Functions Handheld Showerhead W/Non-Positive Shut Off-1.5 GPM 24" Slide Bar with Brass Mounts 60" Stainless Steel Flex Hose Brass Drop Ell with Vacuum Breake	Chrome	4	\$273.50
	P-2302T-ADA	Less Diverter Tub Spout	Chrome	4	\$257.50
	 P-2303T-ADA	Single Handle Valve Trim Set W/Handheld Shower Metal Lever Handle Face Plate For Use with P-2300B & P-2400B Series Valves - Valve not included  Five Functions Handheld Showerhead W/Non-Positive Shut Off-1.5 GPM 24" Slide Bar with Brass Mounts 60" Stainless Steel Flex Hose Brass Drop Ell with Vacuum Breaker	Chrome	4	\$187.00
<b>PARTS</b>	OP-140008	Lever Handle	Chrome	---	\$17.90
	OP-140014	Metal Lever Handle	Chrome	---	\$16.90
	OP-140015	Lever Handle	Chrome	---	\$21.00
	OP-440009	Face Plate Set	Chrome	---	\$20.40
	OP-440010	Face Plate Screw	Chrome	---	\$3.00
	OP-440011	Face Plate Rubber Gasket	---	---	\$2.40
	OP-440033	Adapter	---	---	\$4.10
	OP-490011	Allen Wrench 3/32"	---	---	\$0.70
	OP-640001	Shower Arm Flange	Chrome	---	\$1.20
	OP-640002	6" Shower Arm	Chrome	---	\$11.00
	OP-640027	Single Function Standard Showerhead	Chrome	---	\$21.00
	OP-640029	Three Functions Pulsating Showerhead	Chrome	---	\$25.50
	OP-640018	Combo Diverter Tub Spout	Chrome	---	\$19.90

Low flow showerheads available upon request.

Olympia showerheads meet ANSI/ASME A112.18.1 flow requirements of maximum 1.75 GPM

# TUB & SHOWER // Pressure Balance Trim Sets

## PRESSURE BALANCE TUB / COMPLETE SHOWER SETS



	Model#	Description	Finish	Case	Price
<b>PARTS</b>	OP-640019	Combo Tub Spout	Chrome	---	\$13.30
	OP-640020	8" Shower Arm	Chrome	---	\$13.00
	OP-640022	Three Functions Pulsating Showerhead	Chrome	---	\$21.50
	OP-640024	Single Function Standard Showerhead	Chrome	---	\$16.90
	OP-640035	Four Functions Showerhead	Chrome	---	\$33.70
	OP-140014	Metal Lever Handle	Chrome	---	\$16.90
	OP-440009	Face Plate Set	Chrome	---	\$20.40
	OP-440010	Face Plate Screw	Chrome	---	\$3.00
	OP-440011	Face Plate Rubber Gasket	---	---	\$2.40
	OP-490011	Allen Wrench 3/32"	---	---	\$0.70
	OP-640001	Shower Arm Flange	Chrome	---	\$1.20
	OP-640002	6" Shower Arm	Chrome	---	\$11.00
	OP-640027	Single Function Standard Showerhead	Chrome	---	\$21.00
	OP-640018	Combo Diverter Tub Spout	Chrome	---	\$19.90
	OP-640019	Combo Tub Spout	Chrome	---	\$13.30
	OP-640020	8" Shower Arm	Chrome	---	\$13.00
	OP-640024	Single Function Standard Showerhead	Chrome	---	\$16.90

Low flow showerheads available upon request.

Olympia showerheads meet ANSI/ASME A112.18.1 flow requirements of maximum 1.75 GPM

# TUB & SHOWER // Single Handle Shower Sets

## SINGLE HANDLE TUB / SHOWER SETS



	Model#	Description	Finish	Case	Price	
		<b>P-2000</b>	Single Handle Tub/Shower Set Metal Lever Handle Face Plate 1/2" IPS Female Inlets Stainless Steel Ball Operation Single Function 1-3/4" Showerhead, Arm & Flange 1/2" IPS Diverter Tub Spout With 2.5 GPM Flow Rate Non-Pressure Balance Valve Included	Chrome	12	\$76.00
		<b>P-2002</b>	Single Handle Shower Set Metal Lever Handle Face Plate 1/2" IPS Female Inlets Stainless Steel Ball Operation Single Function 1-3/4" Showerhead, Arm & Flange With 2.5 GPM Flow Rate Non-Pressure Balance Valve Included	Chrome	12	\$72.50
		<b>P-2002-BN</b>	Single Handle Shower Set Metal Lever Handle Face Plate 1/2" IPS Female Inlets Stainless Steel Ball Operation Single Function 1-3/4" Showerhead, Arm & Flange With 2.5 GPM Flow Rate Non-Pressure Balance Valve Included	PVD Brushed Nickel	12	\$115.50
<b>PARTS</b>	<b>OP-140006</b>	Metal Lever Handle	Chrome	---	\$9.80	
	<b>OP-390001</b>	Stainless Steel Ball	---	---	\$3.50	
	<b>OP-440018</b>	Face Plate Set	Chrome	---	\$21.00	
	<b>OP-440019</b>	Face Plate Screw	Chrome	---	\$2.40	
	<b>OP-440020</b>	Valve Plug	---	---	\$3.00	
	<b>OP-490003</b>	Cap and Adjusting Ring	Chrome	---	\$7.00	
	<b>OP-490004</b>	Cam and Washer	---	---	\$4.60	
	<b>OP-490036</b>	Allen Wrench 1/8"	---	---	\$0.70	
	<b>OP-490041</b>	Springs and Seats	---	---	\$1.20	
	<b>OP-640001</b>	Shower Arm Flange	Chrome	---	\$1.20	
	<b>OP-640002</b>	6" Shower Arm	Chrome	---	\$11.00	
	<b>OP-640005</b>	Single Function Standard Showerhead	Chrome	---	\$5.90	
	<b>OP-640014</b>	1/2" IPS Tub Spout	Chrome	---	\$9.90	
	<b>OP-640015</b>	1/2" IPS Diverter Tub Spout	Chrome	---	\$15.70	

This is not a pressure balance valve. It may not meet local code.

Olympia showerheads meet ANSI/ASME A112.18.1 flow requirements of maximum 2.5 GPM

# TUB & SHOWER // Multi Handle Shower Sets

## TWO & THREE HANDLE TUB / SHOWER SETS

	Model#	Description	Finish	Case	Price
	P-1220	Two Handle Tub/Shower Set Acrylic Round Handles Built-in Transfer Valve 1/2" IPS Female Inlets Compression Stem Operation Single Function 1-3/4" Showerhead, Arm & Flange 1/2" IPS Diverter Tub Spout With 2.5 GPM Flow Rate 8" Cast Brass Valve body Included	Chrome	12	\$81.50
	P-1222	Two Handle Shower Set Acrylic Round Handles Built-in Transfer Valve 1/2" IPS Female Inlets Compression Stem Operation Single Function 1-3/4" Showerhead, Arm & Flange With 2.5 GPM Flow Rate 8" Cast Brass Valve body Included	Chrome	12	\$78.00
	P-1210	Two Handle Tub/Shower Set Metal Round Handles Built-in Transfer Valve 1/2" IPS Female Inlets Compression Stem Operation Single Function 1-3/4" Showerhead, Arm & Flange 1/2" IPS Diverter Tub Spout With 2.5 GPM Flow Rate 8" Cast Brass Valve body Included	Chrome	12	\$84.00
	P-1212	Two Handle Shower Set Metal Round Handles Built-in Transfer Valve 1/2" IPS Female Inlets Compression Stem Operation Single Function 1-3/4" Showerhead, Arm & Flange With 2.5 GPM Flow Rate 8" Cast Brass Valve body Included	Chrome	12	\$80.50
	P-3220	Three Handle Tub/Shower Set Acrylic Round Handles 1/2" IPS Female Inlets Compression Stem Operation Single Function 1-3/4" Showerhead, Arm & Flange 1/2" IPS Tub Spout With 2.5 GPM Flow Rate 8" Cast Brass Valve body Included	Chrome	12	\$110.50

This is not a pressure balance valve. It may not meet local code.

Olympia showerheads meet ANSI/ASME A112.18.1 flow requirements of maximum 2.5 GPM

TUB & SHOWER

# TUB & SHOWER // Multi Handle Shower Sets

## THREE HANDLE TUB / SHOWER SETS







	Model#	Description	Finish	Case	Price
	P-3210	Three Handle Tub/Shower Set Metal Round Handles 1/2" IPS Female Inlets Compression Stem Operation Single Function 1-3/4" Showerhead, Arm & Flange 1/2" IPS Tub Spout With 2.5 GPM Flow Rate 8" Cast Brass Valve body Included	Chrome	12	\$113.00
<b>PARTS</b>	OP-140004V	Large Metal Round Handle Set-Diverter	Chrome	---	\$9.80
	OP-140005V	Large Acrylic Round Handle Set-Diverter	---	---	\$5.90
	OP-190009C	Large Acrylic Round Handle-Cold	---	---	\$5.90
	OP-190009H	Large Acrylic Round Handle-Hot	---	---	\$5.90
	OP-190013C	Large Metal Round Handle-Cold	Chrome	---	\$9.80
	OP-190013H	Large Metal Round Handle-Hot	Chrome	---	\$9.80
	OP-340001	Stem Set	---	---	\$15.60
	OP-340002	Diverter Stem Set	---	---	\$13.80
	OP-440008	Diverter Piston	---	---	\$0.70
	OP-440012	Valve Escutcheon	Chrome	---	\$4.60
	OP-440013	Plastic Nipple	---	---	\$0.70
	OP-440014	Shower Seat	---	---	\$1.70
	OP-440015	Tailpiece Union	---	---	\$4.10
	OP-440016	Tailpiece Locknut	---	---	\$4.60
	OP-440017	Mounting Mud Guard	---	---	\$1.10
	OP-490025	Large Acrylic Handle Screw	Chrome	---	\$1.20
	OP-640001	Shower Arm Flange	Chrome	---	\$1.20
	OP-640002	6" Shower Arm	Chrome	---	\$11.00
	OP-640005	Single Function Standard Showerhead	Chrome	---	\$5.90
	OP-640014	1/2" IPS Tub Spout	Chrome	---	\$9.90
OP-640015	1/2" IPS Diverter Tub Spout	Chrome	---	\$15.70	

This is not a pressure balance valve. It may not meet local code.

Olympia showerheads meet ANSI/ASME A112.18.1 flow requirements of maximum 2.5 GPM

# TUB & SHOWER // Multi Handle Shower Sets

## TWO & THREE HANDLE TUB / SHOWER SETS

		Model#	Description	Finish	Case	Price
		P-1230	Two Handle Tub/Shower Set Lever Handles	Chrome	12	\$121.00
		P-1230-BN	Built-in Transfer Valve 1/2" IPS Female Inlets Washerless Cartridge Operation Single Function 2-1/4" Standard Showerhead, Arm & Flange With 2.5 GPM Flow Rate 1/2" IPS Diverter Tub Spout 8" Cast Brass Valve body Included	PVD Brushed Nickel	12	\$159.00
		P-1232	Two Handle Shower Set Lever Handles	Chrome	12	\$108.00
		P-1232-BN	Built-in Transfer Valve 1/2" IPS Female Inlets Washerless Cartridge Operation Single Function 2-1/4" Standard Showerhead, Arm & Flange With 2.5 GPM Flow Rate 8" Cast Brass Valve body Included	PVD Brushed Nickel	12	\$136.50
		P-1250	Two Handle Tub/Shower Set Lever Handles	Chrome	12	\$126.00
		P-1250-BN	Built-in Transfer Valve 1/2" IPS Female Inlets Washerless Cartridge Operation Single Function 2-1/4" Standard Showerhead, Arm & Flange With 2.5 GPM Flow Rate 1/2" IPS Diverter Tub Spout 8" Cast Brass Valve body Included	PVD Brushed Nickel	12	\$187.50
		P-3230	Three Handle Tub/Shower Set Lever Handles	Chrome	6	\$144.00
		P-3230-BN	1/2" IPS Female Inlets Washerless Cartridge Operation Single Function 2-1/4" Standard Showerhead, Arm & Flange With 2.5 GPM Flow Rate 1/2" IPS Tub Spout 8" Cast Brass Valve body Included	PVD Brushed Nickel	6	\$192.00



TUB & SHOWER

This is not a pressure balance valve. It may not meet local code.  
Low flow showerheads available upon request.

Olympia showerheads meet ANSI/ASME A112.18.1 flow requirements of maximum 1.75 GPM

# TUB & SHOWER // Multi Handle Shower Sets

## THREE HANDLE TUB / SHOWER SETS





		Model#	Description	Finish	Case	Price
		P-3250	Three Handle Tub/Shower Set Lever Handles	Chrome	6	\$149.00
		P-3250-BN	1/2" IPS Female Inlets Washerless Cartridge Operation Single Function 2-1/4" Standard Showerhead, Arm & Flange 1/2" IPS Tub Spout With 2.5 GPM Flow Rate 8" Cast Brass Valve body Included	PVD Brushed Nickel	6	\$198.00
<b>PARTS</b>		OP-140009	Lever Handle	Chrome	---	\$10.40
		OP-190015C	Lever Handle-Cold	Chrome	---	\$14.30
		OP-340006C	Cartridge Unit-Cold	---	---	\$4.10
		OP-340006H	Cartridge Unit-Hot	---	---	\$4.10
		OP-340007	Diverter Stem Unit	---	---	\$5.90
		OP-440015	Tailpiece Union	---	---	\$4.10
		OP-440016	Tailpiece Locknut	---	---	\$4.60
		OP-440017	Mounting Mud Guard	---	---	\$1.10
		OP-440034	Diverter Piston	---	---	\$1.80
		OP-440035	Stem Extension	---	---	\$3.50
		OP-440036	Sleeve	Chrome	---	\$11.60
		OP-440037	Flange	Chrome	---	\$6.50
		OP-490011	Allen Wrench 3/32"	---	---	\$0.70
		OP-490041	Springs and Seats	---	---	\$1.20
		OP-640001	Shower Arm Flange	Chrome	---	\$1.20
		OP-640002	6" Shower Arm	Chrome	---	\$11.00
		OP-640003	Single Function Standard Showerhead	Chrome	---	\$15.90
		OP-640014	1/2" IPS Tub Spout	Chrome	---	\$9.90
		OP-640015	1/2" IPS Diverter Tub Spout	Chrome	---	\$15.70

This is not a pressure balance valve. It may not meet local code.  
Low flow showerheads available upon request.

Olympia showerheads meet ANSI/ASME A112.18.1 flow requirements of maximum 2.5 GPM

# TUB & SHOWER // Handheld Shower Sets

## HANDHELD SHOWER SETS

	Model#	Description	Finish	Case	Price	
	P-4420	Handheld Shower Set Five Functions Handheld Showerhead	Chrome	12	\$151.00	
	P-4420-BN	24" Slide Bar with Brass Mounts	PVD Brushed Nickel	12	\$260.00	
	P-4420-ORB	60" Stainless Steel Flex Hose Shower Arm 2-Way Diverter Divert Water To Showerhead or Handheld Showerhead	Oil Rubbed Bronze	12	\$286.00	
		P-4430	Handheld Shower Set Five Functions Handheld Showerhead	Chrome	12	\$144.00
		P-4430-BN	24" Slide Bar with Brass Mounts	PVD Brushed Nickel	12	\$248.00
		P-4430-ORB	60" Stainless Steel Flex Hose Brass Drop Ell with Vacuum Breaker	Oil Rubbed Bronze	12	\$273.00
		P-4430-MZ	Valve Sold Separately	Moroccan Bronze	12	\$287.00
		P-4432-E1.5	Handheld Shower Set Five Functions Handheld Showerhead W/Shut Off	Chrome	12	\$159.50
		P-4432-E1.5-BN	24" Slide Bar with Brass Mounts 60" Stainless Steel Flex Hose Brass Drop Ell with Vacuum Breaker With 1.5 GPM Flow Rate Valve Sold Separately	PVD Brushed Nickel	12	\$273.50
	P-2240	Single Handle Diverter Set Lever Handle	Chrome	20	\$53.50	
	P-2240-BN	Brass Diverter Valve Assembly 1/2" IPS Connection	PVD Brushed Nickel	20	\$76.00	

Low flow showerheads available upon request.

Olympia showerheads meet ANSI/ASME A112.18.1 flow requirements of maximum 1.75 GPM



# TUB & SHOWER // Handheld Shower Sets

## HANDHELD SHOWER SETS

	Model#	Description	Finish	Case	Price
<b>PARTS</b>	OP-140009	Lever Handle	Chrome	---	\$10.40
	OP-360001	Diverter Stem Unit	---	---	\$14.80
	OP-440014	Shower Seat	---	---	\$1.70
	OP-440020	Valve Plug	---	---	\$3.00
	OP-460001	Stem Extension	---	---	\$3.00
	OP-460002	Flange	Chrome	---	\$13.30
	OP-460005	Sleeve	Chrome	---	\$9.40
	OP-460006	Drop Ell	Chrome	---	\$32.70
	OP-460021	Hose	Chrome	---	\$22.00
	OP-460009B	Bottom Brass Mount	Chrome	---	\$22.00
	OP-460009T	Top Brass Mount	Chrome	---	\$22.00
	OP-460010	Slide Bar and Hose Support	Chrome	---	\$83.20
	OP-460011	Screw	---	---	\$1.10
	OP-460013	Two Way Diverter	Chrome	---	\$26.10
	OP-460020	Vacuum Breaker	Chrome	---	\$12.30
	OP-460021	Hose W/1.75 GPM Restrictor	Chrome	---	\$23.00
	OP-490011	Allen Wrench 3/32"	---	---	\$0.70
	OP-560001	Mounting Kit	---	---	\$1.80
	OP-660003	Five Functions Handheld Shower	Chrome	---	\$34.70
	OP-660005	Five Functions Handheld Showerhead W/Non-Positive Shut Off-1.5 GPM	Chrome	---	\$43.00

# BATH & SHOWER // Roman Tub Sets





## ROMAN TUB SETS / VALVES

	Model#	Description	Finish	Case	Price
	P-1131B	Two Handle Roman Tub Valve Set 1/2" IPS Connections Quick Mount Connector Deck or Ledge Mount Ceramic Disc Cartridges 3-Hole 8" to 16" Installation Brass Plug 12" SS Flex Hose, Mud Guards Included	---	12	\$110.00
<b>PARTS</b>	OP-340004C	Ceramic Cartridge-Cold	---	---	\$11.60
	OP-340004H	Ceramic Cartridge-Hot	---	---	\$11.60
	OP-440025	Flex Hose Connector	---	---	\$18.90
	OP-440026	Tee Connector	---	---	\$11.60
	OP-490006	Bonnet Nut	---	---	\$5.30
	OP-540004	Valve Mounting Kit	---	---	\$8.90
	OP-540005	Shank Mounting Kit	---	---	\$9.20
	OP-540006	Shank	---	---	\$18.90
	P-1131T	Two Handle Roman Tub Trim Set Lever Handles	Chrome	6	\$160.00
	P-1131T-BN	C Style Rigid Spout 7-1/2" Reach	PVD Brushed Nickel	6	\$192.00
	P-1131T-ORB	3-Hole 8" to 16" Installation	Oil Rubbed Bronze	6	\$215.00
	P-1131T-MZ	Trim Only, P-1131B Valve Required	Moroccan Bronze	6	\$226.00
<b>PARTS</b>	OP-140007	Lever Handle	Chrome	---	\$32.20
	OP-240007	C Spout	Chrome	---	\$130.10
	OP-440027	Male Thread Streamer	Chrome	---	\$5.30
	OP-440028	C Spout Button	Chrome	---	\$0.70
	OP-440029	C Spout Allen Screw	---	---	\$0.70
	OP-440030	Spout Escutcheon	Chrome	---	\$21.50
	OP-440031	Valve Escutcheon	Chrome	---	\$27.10
	OP-490011	Allen Wrench 3/32"	---	---	\$0.70
	OP-490036	Allen Wrench 1/8"	---	---	\$0.70
	OP-490044	Stem Extension	---	---	\$4.60

TUB & SHOWER

# TUB & SHOWER // Valves

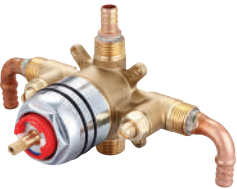



## PRESSURE BALANCE VALVES

	Model#	Description	Finish	Case	Price
	P-2300B	Single Handle Tub/Shower Valve Combo CXC and IPS Inlet and Outlet Connections	Rough Brass	12	\$88.00
	P-2300B-B*	Pressure Balance Spool Included Brass Inlet Stops Ceramic Disc Cartridge With Temperature Limit Stop Back to Back Installation  *Builder Tract Pack	Rough Brass	12	\$86.00
	P-2400B	Single Handle Tub and Shower Valve Combo CXC and IPS Inlet and Outlet Connections	Rough Brass	12	\$83.50
	P-2400B-B*	Pressure Balance Spool Included Ceramic Disc Cartridge With Temperature Limit Stop Back to Back Installation  *Builder Tract Pack	Rough Brass	12	\$81.50
	P-2301B	Single Handle Tub/Shower Valve 1/2" PEX Inlet & Shower Outlet W/Combo CXC & IPS Tub Outlet	Rough Brass	12	\$104.00
	P-2301B-B*	Pressure Balance Spool Included Brass Inlet Stops Ceramic Disc Cartridge With Temperature Limit Stop Back to Back Installation  *Builder Tract Pack	Rough Brass	12	\$102.00
	P-2302B	Single Handle Tub/Shower Valve 1/2" PEX Inlet & Shower Outlet W/Combo CXC & IPS Tub Outlet	Rough Brass	12	\$104.00
	P-2302B-B*	Pressure Balance Spool Included Brass Inlet Stops Ceramic Disc Cartridge With Temperature Limit Stop Back to Back Installation  *Builder Tract Pack	Rough Brass	12	\$102.00
	P-2403B	Single Handle Tub/Shower Valve 1/2" CPVC Inlet W/Combo CXC & IPS Outlet	Rough Brass	12	\$90.50
	P-2403B-B*	Pressure Balance Spool Included Ceramic Disc Cartridge With Temperature Limit Stop Back to Back Installation  *Builder Tract Pack	Rough Brass	12	\$88.50
	P-2405B	Single Handle Tub/Shower Valve 1/2" PEX Inlet W/Combo CXC & IPS Outlet	Rough Brass	12	\$96.50
	P-2405B-B*	Pressure Balance Spool Included Ceramic Disc Cartridge With Temperature Limit Stop Back to Back Installation  *Builder Tract Pack	Rough Brass	12	\$94.50

Builder Tract Packs sold in case quantities only.

# TUB & SHOWER // Valves

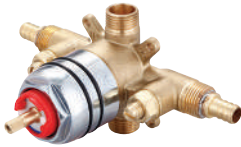
## PRESSURE BALANCE VALVES



	Model#	Description	Finish	Case	Price
	P-2303B	Single Handle Tub and Shower Valve 1/2" CPVC Inlet W/Combo CXC & IPS Outlet	Rough Brass	12	\$98.00
	P-2303B-B*	Pressure Balance Spool Included Brass Inlet Stops Ceramic Disc Cartridge With Temperature Limit Stop Back to Back Installation  *Builder Tract Pack	Rough Brass	12	\$96.00
	P-2304B	Single Handle Tub/Shower Valve 1/2" PEX Inlet & Shower Outlet W/Copper Stub Tub	Rough Brass	6	\$121.00
	P-2304B-B*	Outlet Pressure Balance Spool Included Brass Inlet Stops Ceramic Disc Cartridge With Temperature Limit Stop Back to Back Installation  *Builder Tract Pack	Rough Brass	6	\$119.00
	P-2305B	Single Handle Tub and Shower Valve 1/2" PEX Inlet W/Combo CXC & IPS Outlet	Rough Brass	12	\$102.00
	P-2305B-B*	Pressure Balance Spool Included Brass Inlet Stops Ceramic Disc Cartridge With Temperature Limit Stop Back to Back Installation  *Builder Tract Pack	Rough Brass	12	\$100.00
	P-2306B	Single Handle Tub/Shower Valve 1/2" PEX Inlet & Shower Outlet W/Copper Stub Tub	Rough Brass	6	\$121.00
	P-2306B-B*	Outlet Pressure Balance Spool Included Brass Inlet Stops Ceramic Disc Cartridge With Temperature Limit Stop Back to Back Installation  *Builder Tract Pack  Note: Color Match Sleeve Ships with shower trim on All Valves	Rough Brass	6	\$119.00

Builder Tract Packs sold in case quantities only.

# TUB & SHOWER // Valves

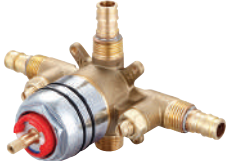

## NEW VALVES

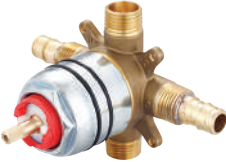
### PRESSURE BALANCE VALVES

	Model#	Description	Finish	Case	Price
	P-2307B	Single Handle Tub/Shower Valve 1/2" Uponor PEX Inlet W/Combo CXC & IPS Outlet	Rough Brass	12	\$107.00
	P-2307B-B*	Pressure Balance Spool Included Brass Inlet Stops Ceramic Disc Cartridge With Temperature Limit Stop Back to Back Installation  *Builder Tract Pack	Rough Brass	12	\$105.00
	P-2308B	Single Handle Tub/Shower Valve 1/2" Uponor PEX Inlet & Shower Outlet	Rough Brass	12	\$109.00
	P-2308B-B*	W/Combo CXC & IPS Tub Outlet Pressure Balance Spool Included Brass Inlet Stops Ceramic Disc Cartridge With Temperature Limit Stop Back to Back Installation  *Builder Tract Pack	Rough Brass	12	\$107.00
	P-2309B	Single Handle Tub/Shower Valve 1/2" Uponor PEX Inlet & Shower Outlet	Rough Brass	6	\$121.00
	P-2309B-B*	W/Copper Stub Tub Outlet Pressure Balance Spool Included Brass Inlet Stops Ceramic Disc Cartridge With Temperature Limit Stop Back to Back Installation  *Builder Tract Pack	Rough Brass	6	\$119.00
	P-2407B	Single Handle Tub/Shower Valve 1/2" Uponor PEX Inlet W/Combo CXC & IPS Outlet	Rough Brass	12	\$102.50
	P-2407B-B*	Pressure Balance Spool Included Ceramic Disc Cartridge With Temperature Limit Stop Back to Back Installation  *Builder Tract Pack	Rough Brass	12	\$100.50
<b>PARTS</b>	OP-340009	Ceramic Cartridge W/Spring	---	---	\$39.30
	OP-440007	Inlet Supply Stop	---	---	\$9.20
	OP-440021	Valve Mud Guard	---	---	\$3.50
	OP-440053	Sleeve Nut	Chrome	---	\$5.00
	OP-440054	Sleeve			\$6.00
	OP-440023	Outlet Plastic Protection Cap	---	---	\$0.70
	OP-440024	Valve Mud Guard Screw	---	---	\$1.20
	OP-440044	Check Valve and Sleeve	Chrome	---	\$9.90
	OP-440045	Tub/Shower-1" Extension	---	---	\$41.90

# ACCESSORIES // Lavatory Drains

## LAVATORY DRAINS

	Model#	Description	Finish	Case	Price
	OP-630004	50/50 Pop-Up Drain Assembly For Use With Sinks With Overflow Drains	Chrome	---	\$22.00
	OP-630004-BN	1-1/2" 50/50 Pop-Up Drain	PVD Brushed Nickel	---	\$24.00
	OP-630004-ORB		Oil Rubbed Bronze	---	\$25.00
<b>PARTS</b>	OP-430016	Pop-Up Stopper	---	---	\$4.80
	OP-430017	Pop-Up Horizontal Rod Group	---	---	\$4.00
	OP-430018	Pop-Up Top Flange	---	---	\$4.80
	OP-430019	Pop-Up Bracket & Screw	---	---	\$1.70
	OP-530004	Pop-Up Mounting Kit	---	---	\$3.30
	OP-630002	Brass Pop-Up Drain Assembly For Use With Sinks With Overflow Drains	Chrome	---	\$27.10
	OP-630002-BN	1-1/2" All Brass Pop-Up Drain	PVD Brushed Nickel	---	\$29.60
	OP-630002-ORB		Oil Rubbed Bronze	---	\$30.60
<b>PARTS</b>	OP-430008	Pop-Up Stopper	---	---	\$2.50
	OP-430009	Pop-Up Horizontal Rod Group	---	---	\$2.50
	OP-430020	Pop-Up Bracket & Screw	---	---	\$1.70
	OP-530003	Pop-Up Mounting Kit	---	---	\$4.80
	OP-630001	Brass Grid Strainer Drain Assembly For Use With Sinks With Overflow Drains 1-1/2" All Brass Grid Drain	Chrome	---	\$27.60

ACCESSORIES





# ACCESSORIES // Tub Spouts

## TUB SPOUTS

	Model#	Description	Finish	Case	Price
	OP-640018	Combo Diverter Tub Spout Zinc Die Cast Construction	Chrome	---	\$19.90
	OP-640018-BN	5-1/4" Reach	PVD Brushed Nickel	---	\$26.00
	OP-640018-ORB	1/2" IPS or Slip-Fit Installation	Oil Rubbed Bronze	---	\$28.20
	OP-640019	Combo Tub Spout Zinc Die Cast Construction	Chrome	---	\$13.30
	OP-640019-BN	5-1/4" Reach	PVD Brushed Nickel	---	\$22.40
	OP-640019-ORB	1/2" IPS or Slip-Fit Installation	Oil Rubbed Bronze	---	\$24.30
	OP-640015	1/2" IPS Diverter Tub Spout Zinc Die Cast Construction	Chrome	---	\$15.70
	OP-640015-BN	5-1/4" Reach	PVD Brushed Nickel	---	\$21.50
	OP-640014	1/2" IPS Tub Spout Zinc Die Cast Construction	Chrome	---	\$9.90
	OP-640014-BN	5-1/4" Reach	PVD Brushed Nickel	---	\$16.40
	OP-640033	Extended Front Lift Diverter Tub Spout-Combo 1/2" IPS/ Slip-On Inlet	Chrome	---	\$40.80
	OP-640033-BN	Zinc Die Cast Construction 7" Reach 1/2" IPS or Slip-Fit Installation	PVD Brushed Nickel	---	\$56.70
	OP-640034	Extended Tub Spout-Combo 1/2" IPS/Slip-On Inlet Zinc Die Cast Construction	Chrome	---	\$33.70
	OP-640034-BN	7" Reach 1/2" IPS or Slip-Fit Installation	PVD Brushed Nickel	---	\$48.00
	OP-640040	Extended i2 Combo Diverter Tub Spout Zinc Die Cast Construction	Chrome	---	\$55.00
	OP-640040-BN	7" Reach 1/2" IPS or Slip-Fit Installation	PVD Brushed Nickel	---	\$69.50

# ACCESSORIES // Showerheads

## SHOWERHEADS

	Model#	Description	Finish	Case	Price
	OP-640003	Single Function Standard Showerhead-2.50 GPM Adjustable Flow	Chrome	---	\$15.90
	OP-640003-BN	2-1/4" Face	PVD Brushed Nickel	---	\$23.00
	OP-640003-ORB		Oil Rubbed Bronze	---	\$26.10
	OP-640024	Single Function Standard Showerhead-1.50 GPM Adjustable Flow	Chrome	---	\$16.90
	OP-640024-BN	2-1/4" Face	PVD Brushed Nickel	---	\$24.00
	OP-640024-ORB		Oil Rubbed Bronze	---	\$27.60
	 OP-640027	Single Function Standard Showerhead-1.75 GPM Adjustable Flow	Chrome	---	\$21.00
	OP-640027-BN	2-1/4" Face	PVD Brushed Nickel	---	\$28.60
	OP-640027-ORB		Oil Rubbed Bronze	---	\$31.70
	OP-640016*	Three Functions Pulsating Showerhead-2.50 GPM 3 Spray Patterns	Chrome	---	\$20.40
	OP-640016-BN*	Brass Ball Swivel Joint	PVD Brushed Nickel	---	\$31.70
	OP-640016-ORB*	2-1/2" Face	Oil Rubbed Bronze	---	\$34.70
	OP-640022	Three Functions Pulsating Showerhead-1.50 GPM 3 Spray Patterns	Chrome	---	\$21.50
	OP-640022-BN	Brass Ball Swivel Joint	PVD Brushed Nickel	---	\$32.70
	OP-640022-ORB	2-1/2" Face	Oil Rubbed Bronze	---	\$35.70
	 OP-640029	Three Functions Pulsating Showerhead-1.75 GPM 3 Spray Patterns	Chrome	---	\$25.50
	OP-640029-BN	Brass Ball Swivel Joint	PVD Brushed Nickel	---	\$36.80
	OP-640029-ORB	2-1/2" Face	Oil Rubbed Bronze	---	\$39.80
	OP-640005	Single Function Standard Showerhead-2.50 GPM Adjustable Flow	Chrome	---	\$5.90
	OP-640005-BN	1-3/4" Face	PVD Brushed Nickel	---	\$11.60
	 OP-640031	Single Function Standard Showerhead-1.75 GPM Adjustable Flow	Chrome	---	\$11.10
	OP-640031-BN	1-3/4" Face	PVD Brushed Nickel	---	\$16.90
	OP-640023*	Four Functions Showerhead-2.50 GPM Rub-Clean Anti-Scale Spray	Chrome	---	\$28.60
	OP-640023-BN*	Brass Ball Swivel Joint	PVD Brushed Nickel	---	\$35.70
	OP-640023-ORB*	3-3/8" Face	Oil Rubbed Bronze	---	\$38.80
	 OP-640035	Four Functions Showerhead-1.75 GPM Rub-Clean Anti-Scale Spray	Chrome	---	\$33.70
	OP-640035-BN	Brass Ball Swivel Joint	PVD Brushed Nickel	---	\$40.80
	OP-640035-ORB	3-3/8" Face	Oil Rubbed Bronze	---	\$43.90





Low flow showerheads available upon request.  
\*While supplies last.

Olympia showerheads meet ANSI/ASME A112.18.1 flow requirements of maximum 1.75 GPM

ACCESSORIES





# ACCESSORIES // Strainers

## STRAINERS

	Model#	Description	Finish	Case	Price
	ACS-300100	Stainless Steel Duo Basket Strainer Heavy Duty Design Fits all 3-1/2" or 4" Drain Opening Long Lasting Finish Removable Basket Strainer with Open/Close Stopper that Seals Tightly Post Type Strainer	Chrome	50	\$7.50
	ACS-300200	Stainless Steel Easy Connect Basket Strainer Heavy Duty Design Fits all 3-1/2" or 4" Drain Opening Long Lasting Finish Features Quick Locking Easy Installation System Post Type Strainer	Chrome	50	\$10.50
	ACS-300400	Stainless Steel Double Cup Basket Strainer Heavy Duty Design Fits all 3-1/2" or 4" Drain Opening Long Lasting Finish Removable Basket Strainer with Open/Close Stopper that Seals Tightly Post Type Strainer Features Long Shank for Extra Thick Deck	Chrome	50	\$13.00
	ACS-300500	Stainless Steel Spin & Seal Basket Strainer Heavy Duty Design Fits all 3-1/2" or 4" Drain Opening Long Lasting Finish Removable Basket Strainer with Open/Close Stopper that Seals Tightly Spin Type Strainer Features Spin & Seal Operation	Chrome	50	\$15.50

# ACCESSORIES // Misc. Parts

MISC. PARTS

	Model#	Description	Finish	Case	Price
	ACS-903100	Dishwasher Air Gap Plastic Body Included	Chrome	96	\$7.50
	ACS-903100-BN	1-3/4" Cap Diameter 2-1/2" Cap Height	PVD Brushed Nickel	96	\$11.00
	ACS-903100-ORB	8-7/8" Overall Height With Plastic Body	Oil Rubbed Bronze	96	\$12.50
	ACS-903500	Soap/Lotion Dispenser Solid Brass	Chrome	25	\$24.00
	ACS-903500-BN	Heavy Metal Dispenser Plastic Bottle Includes Bottle and Dispenser Pump Dispenser Capacity 12 Oz. Fits 3/4" Thick Deck 1-1/2" Optional Extension available for Thicker Deck	PVD Brushed Nickel	25	\$33.00
<b>PARTS</b>	OP-420023	Shank Extension For Soap/Lotion Dispenser	---	---	\$8.40
	OP-640017	Renovation Face Plate Face Plate converts 2 or 3 Handle Shower to 1 Handle With no Tile Replacements	Chrome	---	\$63.80
	OP-640017-BN	Works with All Olympia Pressure Balance Valves	PVD Brushed Nickel	---	\$97.60
	OP-640017-ORB		Oil Rubbed Bronze	---	\$101.50
	OP-490045	Replacement Parts Kit Genuine Olympia Product's Repair Parts Includes OP-490046 (1 Pc), OP-340008 (1 Pc) OP-390004 (6 Pcs), OP-390005 (6 Pcs) OP-490019 (6 Pcs), OP-420001 (6 Pcs) OP-490026 (2 Pcs), OP-490027 (2 Pcs) OP-430006 (2 Pcs), OP-420005 (2 Pcs) OP-420024 (4 Pcs), OP-390001 (3 Pcs) OP-490004 (3 Pcs), OP-490041 (5 Pcs)	---	---	\$98.00

ACCESSORIES

# ACCESSORIES // Aerators

## AERATORS

Model#	Description	Finish	Case	Price
OP-490026	Aerator - Female 55/64" Thread 2.0 GPM Flow Rate	Chrome	---	\$1.80
OP-490035	Aerator - Female 55/64" Thread 1.5 GPM Flow Rate	Chrome	---	\$6.90
OP-490035-BN		PVD Brushed Nickel	---	\$8.00
OP-490035-ORB		Oil Rubbed Bronze	---	\$9.90
OP-490056	Aerator - Female 55/64" Thread 1.0 GPM Flow Rate	Chrome	---	\$9.90
OP-490056-BN		PVD Brushed Nickel	---	\$11.10
OP-490056-ORB		Oil Rubbed Bronze	---	\$12.60
OP-490055	Aerator - Female 55/64" Thread 0.5 GPM Flow Rate	Chrome	---	\$8.80
OP-490055-BN		PVD Brushed Nickel	---	\$9.90
OP-490055-ORB		Oil Rubbed Bronze	---	\$11.60
OP-490019	Aerator - Male 15/16" Thread 2.0 GPM Flow Rate	Chrome	---	\$2.70
OP-490010	Aerator - Male 15/16" Thread 1.5 GPM Flow Rate	Chrome	---	\$5.70
OP-490010-BN		PVD Brushed Nickel	---	\$7.00
OP-490010-ORB		Oil Rubbed Bronze	---	\$7.90
OP-490058	Aerator - Male 15/16" Thread 1.0 GPM Flow Rate	Chrome	---	\$8.80
OP-490058-BN		PVD Brushed Nickel	---	\$9.90
OP-490058-ORB		Oil Rubbed Bronze	---	\$11.60
OP-490059	Aerator - Male 15/16" Thread 0.5 GPM Flow Rate	Chrome	---	\$8.80
OP-490059-BN		PVD Brushed Nickel	---	\$9.90
OP-490059-ORB		Oil Rubbed Bronze	---	\$11.60
OP-490027	Aerator - Female 55/64" Thread 2.0 GPM Flow Rate	Chrome	---	\$3.00
OP-490057	Aerator - Female 55/64" Thread With 1.5 GPM Flow Rate	Chrome	---	\$8.80
OP-490057-BN		PVD Brushed Nickel	---	\$9.90
OP-490057-ORB		Oil Rubbed Bronze	---	\$11.10
OP-490060	Aerator - Female 55/64" Thread 1.0 GPM Flow Rate	Chrome	---	\$11.10
OP-490060-BN		PVD Brushed Nickel	---	\$12.10
OP-490060-ORB		Oil Rubbed Bronze	---	\$13.10
OP-490061	Aerator - Female 55/64" Thread 0.5 GPM Flow Rate	Chrome	---	\$11.10
OP-490061-BN		PVD Brushed Nickel	---	\$12.10
OP-490061-ORB		Oil Rubbed Bronze	---	\$13.10

# ACCESSORIES // Aerators

## AERATORS

Model#	Description	Finish	Case	Price
OP-430006	Aerator - Female 55/64" Thread 2.0 GPM Flow Rate	Chrome	---	\$5.30
OP-430007	Aerator - Female 55/64" Thread With 1.5 GPM Flow Rate	Chrome	---	\$7.50
OP-430007-BN		PVD Brushed Nickel	---	\$9.90
OP-430007-ORB		Oil Rubbed Bronze	---	\$11.10
OP-430012	Aerator - Female 55/64" Thread 1.0 GPM Flow Rate	Chrome	---	\$10.50
OP-430012-BN		PVD Brushed Nickel	---	\$11.60
OP-430012-ORB		Oil Rubbed Bronze	---	\$12.80
OP-430011	Aerator - Female 55/64" Thread 0.5 GPM Flow Rate	Chrome	---	\$8.80
OP-430011-BN		PVD Brushed Nickel	---	\$13.80
OP-430011-ORB		Oil Rubbed Bronze	---	\$14.80





# CENTRAL BRASS //

**2018 CENTRAL BRASS PRODUCT CATALOG PRICE INDEX**

## 2018 CENTRAL BRASS PRODUCT CATALOG PRICE INDEX

MODEL	PAGE	PCS/ CS	LIST PRICE	MODEL	PAGE	PCS/ CS	LIST PRICE	MODEL	PAGE	PCS/ CS	LIST PRICE
0005-H1/2P	208	6	\$60.50	0048-UA3	174	6	\$155.00	0094-LE0	181	6	\$88.00
0006-H1/2C	208	6	\$44.00	0048-UA4	174	6	\$155.50	0094-LE0-Q	181	6	\$89.80
0006-H1/2H	208	6	\$44.00	0048-UA6	174	6	\$156.00	0094-LE17	181	6	\$100.50
0007-1/2	208	6	\$52.50	0048-ULE0	174	6	\$143.00	0112-AL	215	---	\$19.00
0007-H1/2	208	6	\$55.00	0048-ULE3	174	6	\$158.00	0120-A	168	---	\$129.00
0031-H1/2C	209	6	\$80.20	0050-ULERC	175	6	\$156.50	0120-L	168	---	\$123.00
0031-H1/2H	209	6	\$80.20	0050-ULERC-QI	175	6	\$172.00	0121-A	168	6	\$144.00
0031-H1/2P	209	6	\$80.20	0050-URC	175	6	\$153.50	0122-A	168	6	\$139.00
0033-1/2CV-02	209	6	\$110.00	0050-URC-QI	175	6	\$176.00	0122-GSAELS	169	6	\$180.30
0033-1/2HV-02	209	6	\$110.00	0051-TRC	175	6	\$137.00	0122-GSAELS-Q	168	6	\$182.10
0033-1/2PV-02	209	6	\$110.00	0051-URC	175	6	\$126.50	0122-KSAELS-Q	168	6	\$201.90
0045-LE0	173	6	\$229.50	0054-ULE-Q	175	6	\$193.00	0122-LE1	168	6	\$132.00
0045-LE60	153	4	\$448.90	0054-ULE-QI	175	6	\$238.00	0122-LE17	168	6	\$157.50
0045-LE60-AD0	153	4	\$563.90	0054-ULERC-Q	175	6	\$171.00	0122-LE6	168	6	\$142.00
0045-LE61	154	4	\$477.10	0054-ULERC-QI	175	6	\$185.00	0122-LE60	155	4	\$474.00
0046-LE0	174	6	\$238.00	0054-U-Q	175	6	\$190.00	0122-LE61	156	4	\$505.10
0047-SA	173	6	\$122.85	0054-U-QI	175	6	\$235.00	0123-A	168	6	\$154.00
0047-SA1	173	6	\$131.85	0054-URC-Q	175	6	\$169.00	0123-A07	168	6	\$186.30
0047-SLE0	173	6	\$125.85	0054-URC-QI	175	6	\$182.00	0123-LE1	168	6	\$147.00
0047-TA	173	6	\$122.85	0054-YELRC-Q	175	6	\$246.00	0123-LE2	168	6	\$171.00
0047-TA1	173	6	\$131.85	0054-YELSRC-Q	175	6	\$240.80	0123-LE6	168	6	\$157.00
0047-TA3	173	6	\$137.85	0054-YRC-Q	175	6	\$215.00	0125-A	170	6	\$132.00
0047-TA4	173	6	\$138.35	0072-GSAELS-Q	172	6	\$173.25	0126-A	170	6	\$147.00
0047-TLE0	173	6	\$125.85	0084-A	181	6	\$96.00	0127-A	170	6	\$149.50
0047-TLE17	173	6	\$141.35	0084-A1	181	6	\$105.00	0127-LE1	170	6	\$135.00
0047-UA	173	6	\$125.00	0084-A3	181	6	\$111.00	0127-LE6	170	6	\$152.50
0047-UA1	173	6	\$134.00	0084-A4	181	6	\$111.50	0128-A	170	6	\$164.50
0047-UA2	173	6	\$139.00	0084-A6	181	6	\$112.00	0128-LE1	170	6	\$150.00
0047-UA3	173	6	\$140.00	0084-GRAELS	181	6	\$137.30	0128-LE6	170	6	\$167.50
0047-UA3-Q	173	6	\$141.80	0084-GSA	182	6	\$111.50	0146-A	170	6	\$118.50
0047-UA4	173	6	\$140.50	0084-GSAEL	182	6	\$142.50	0148-LE1	170	6	\$121.50
0047-ULE0	173	6	\$128.00	0084-GSAELS	182	6	\$137.30	0148-LE6	170	6	\$142.00
0047-ULE17	173	6	\$143.50	0084-H	181	6	\$97.30	0149-LE1	170	6	\$136.50
0047-ULE3	173	6	\$143.00	0084-KRAELS	181	6	\$156.60	0149-LE6	170	6	\$157.00
0047-ULE60	153	4	\$433.90	0084-KSA	181	6	\$131.30	0184-LE0	184	6	\$103.00
0047-ULE60-AD0	153	4	\$548.90	0084-KSAELS-Q	181	6	\$158.90	0184-LE60	157	4	\$484.80
0047-ULE60-AD1	153	4	\$557.90	0084-LE0	181	6	\$99.00	0184-LE60-AD0	157	4	\$600.80
0047-ULE61	154	4	\$441.70	0084-LE17	182	6	\$114.50	0184-LE61	158	4	\$534.20
0048-SA	174	6	\$142.00	0084-LE60	155	4	\$472.20	0194-LE0	184	6	\$92.00
0048-SLE0	174	6	\$145.00	0084-LE60-AD0	155	4	\$587.20	0194-LE60	157	4	\$435.10
0048-TA	174	6	\$130.00	0084-LE61	156	4	\$520.60	0194-LE60-AD0	157	4	\$550.10
0048-TA1	174	6	\$139.00	0094-A	181	6	\$85.00	0194-LE61	158	4	\$483.50
0048-TA2	174	6	\$144.00	0094-A1	181	6	\$94.00	0206	199	6	\$58.50
0048-TA3	174	6	\$145.00	0094-A3	181	6	\$100.00	0208	199	6	\$71.00
0048-TA4	174	6	\$145.50	0094-GRA	181	6	\$100.50	0209	199	6	\$80.50
0048-TA-Q	174	6	\$131.80	0094-GSA	181	6	\$100.50	0210	200	6	\$71.00
0048-TLE0	174	6	\$133.00	0094-GSAELS	181	6	\$126.30	0210-Q	200	6	\$72.50
0048-UA	174	6	\$140.00	0094-H	181	6	\$86.30	0211	200	6	\$131.00
0048-UA1	174	6	\$149.00	0094-H1	181	6	\$95.30	0211-Q	200	6	\$132.50
0048-UA2	174	6	\$154.00	0094-H3	181	6	\$101.30	0239-AP	189	6	\$53.50

## 2018 CENTRAL BRASS PRODUCT CATALOG PRICE INDEX

MODEL	PAGE	PCS/ CS	LIST PRICE	MODEL	PAGE	PCS/ CS	LIST PRICE	MODEL	PAGE	PCS/ CS	LIST PRICE
0239-P	189	6	\$49.50	0355-AVN2C	189	6	\$117.50	0650-0	167	6	\$120.00
0255-AC	189	6	\$80.50	0355-AVN2P	189	6	\$117.50	0650-17	167	6	\$135.50
0255-AH	189	6	\$80.50	0356-AN2C	189	6	\$136.00	0650-60	162	4	\$428.90
0255-AP	189	6	\$80.50	0356-AN2P	189	6	\$136.00	0650-60-AD0	162	4	\$543.90
0255-AVC	189	6	\$83.80	0360	206	6	\$89.30	0660	165	6	\$93.90
0255-C	189	6	\$73.40	0361	206	36	\$77.80	0661	166	6	\$92.10
0255-H	189	6	\$73.40	0362	206	36	\$74.40	0808-Z	190	8	\$108.40
0255-P	189	6	\$73.40	0364-L	205	6	\$163.40	0826	190	8	\$117.75
0280-AC	178	6	\$107.00	0364-LV	205	6	\$166.70	0850	191	8	\$108.75
0280-AH	178	6	\$107.00	0365-L	205	6	\$158.50	0868	191	8	\$190.76
0280-GSAC	178	6	\$116.50	0365-LV	205	6	\$161.80	0868-Z	191	8	\$160.25
0280-LE60	159	4	\$366.80	0366-HX8	207	6	\$248.80	0897	190	8	\$143.50
0281-AC	178	6	\$92.50	0366-HX8V	207	6	\$252.10	0905	191	8	\$95.25
0281-AH	178	6	\$92.50	0366-HX8VWB	207	6	\$288.80	0908	191	8	\$146.35
0282	178	6	\$82.80	0366-HX8WB	207	6	\$285.50	0908-Z	191	8	\$116.35
0284-A-Q	179	6	\$164.00	0366-HX8WBD	207	6	\$307.00	0926	192	8	\$126.25
0285-A-Q	179	6	\$178.00	0366-L	205	6	\$156.00	0950	193	8	\$116.75
0285-LE60-AD0-Q	159	4	\$481.80	0366-LV	205	6	\$159.30	0951	193	8	\$147.25
0285-LE61-Q	161	4	\$454.50	0376	207	12	\$37.00	0961	194	8	\$196.75
0286-AC	179	6	\$80.50	0377	207	12	\$61.80	0961-Z	194	8	\$166.75
0286-AH	179	6	\$80.50	0393	177	6	\$82.00	0968	193	8	\$197.90
0287-GSAELS-Q	180	6	\$174.60	0425	207	40	\$28.60	0968-Z	193	8	\$168.25
0287-LE17	179	6	\$147.00	0426	207	40	\$21.90	0971	194	8	\$228.00
0287-LE18	179	6	\$148.80	0455	183	8	\$116.50	0971-Z	194	8	\$198.00
0287-LE60-AD0-Q	160	4	\$541.00	0465	183	6	\$74.75	0997	192	8	\$152.00
0287-LE60-Q	160	4	\$426.00	0465-5	183	6	\$83.75	1008-B	227	1	\$2.50
0287-LE61-Q	161	4	\$466.50	0465-LE	183	6	\$77.75	1011-N	227	1	\$7.50
0289-A	180	6	\$135.00	0466	183	6	\$64.00	1012-N	227	1	\$9.00
0331-1/2	210	6	\$69.40	0466-5	183	6	\$73.00	1109	214	12	\$40.00
0331-3/8	210	6	\$68.00	0468	183	6	\$95.50	1109-BP	214	12	\$50.00
0331-L1/2	210	6	\$71.00	0468-5	183	6	\$104.50	1109-BPLG	214	12	\$46.00
0331-L3/8	210	6	\$70.00	0469	183	6	\$102.50	1109-LG	214	12	\$37.50
0331-LV3/8	210	6	\$73.30	0469-5	183	6	\$111.50	1125-A	187	6	\$149.00
0331-V1/2	210	6	\$72.70	0470	183	6	\$96.50	1125-DA	187	6	\$179.00
0333-1/2	210	6	\$71.90	0470-5	183	6	\$105.50	1130	213	6	\$114.60
0333-3/8	210	6	\$70.90	0471-RC	183	6	\$150.50	1131-B	213	6	\$78.50
0333-L1/2	210	6	\$73.50	0477	199	4	\$105.00	1132-B	213	6	\$88.50
0333-L3/8	210	6	\$72.90	0477-RC	199	4	\$110.00	1133-A	186	6	\$113.50
0333-LV1/2	210	6	\$76.80	0555	211	36	\$44.50	1133-DLE	186	6	\$148.00
0334-1/2	201	6	\$70.00	0555-D	211	36	\$47.50	1133-LE	186	6	\$116.50
0335-1/2	201	6	\$72.40	0575-1/2	212	6	\$38.00	1137-A	185	6	\$112.00
0335-V1/2	201	6	\$75.70	0575-1/2CP	212	6	\$64.00	1137-AELS	185	6	\$132.00
0336-N2-1/2	210	6	\$79.50	0576-1/2	212	6	\$38.00	1137-AELS-Q	185	6	\$133.80
0336-N2-3/8	210	6	\$77.50	0576-1/2CP	212	6	\$64.00	1137-DA	185	6	\$144.00
0342-1/2	214	24	\$20.00	0576-3/4	212	6	\$38.00	1137-DAEL	185	6	\$175.00
0342-1/2VB	214	6	\$65.60	0607-C1/2	211	6	\$41.00	1137-DAELS	185	6	\$164.00
0342-3/8	214	24	\$19.50	0607-C3/4	211	6	\$42.00	1137-DA-Q	185	6	\$145.80
0355-AN2C	189	6	\$114.50	0640	163	4	\$343.20	1137-DLE	185	6	\$147.00
0355-AN2H	189	6	\$114.50	0641	163	4	\$387.20	1137-LE	185	6	\$115.00
0355-AN2P	189	6	\$114.50	0642-LE0	164	6	\$115.00	1138-A	185	6	\$119.00

## 2018 CENTRAL BRASS PRODUCT CATALOG PRICE INDEX

MODEL	PAGE	PCS/ CS	LIST PRICE	MODEL	PAGE	PCS/ CS	LIST PRICE	MODEL	PAGE	PCS/ CS	LIST PRICE
1138-LE	185	6	\$122.00	3127-AN1	188	6	\$270.00	80084-GRAELS	181	6	\$147.80
1167-AV	186	6	\$249.10	3127-AVN1	188	6	\$273.00	80084-GSA	182	6	\$122.00
1172-11AELS-Q	187	6	\$198.00	3137-AN2	186	6	\$206.00	80084-GSAELS	182	6	\$147.80
1172-GRAELS-Q	171	6	\$197.80	3137-AVN2	186	6	\$209.00	80084-LE0	182	6	\$109.50
1172-GSAEL-Q	172	6	\$203.00	3137-DAN2	186	6	\$238.00	80084-LE17	182	6	\$125.00
1172-GSAELS-Q	172	6	\$197.80	3145-D	228	1	\$62.50	80084-LE60	155	4	\$482.20
1172-LE17-Q	171	6	\$175.00	3154-Z	228	1	\$13.00	80084-LE60-AD0	155	4	\$597.20
1172-LE6-Q	171	6	\$159.50	3362	228	1	\$30.00	80084-LE60-AD1	155	4	\$606.20
1173-LE6-Q	171	6	\$174.50	390	226	1	\$7.00	80122-A	168	6	\$149.50
1177-A	186	6	\$134.30	510	226	1	\$7.10	80122-A07	168	6	\$181.80
1177-DA	186	6	\$166.30	521-B	226	1	\$8.40	80122-GSAELS	169	6	\$190.80
1177-DLE	186	6	\$169.30	524-B	227	1	\$6.00	80123-A	168	6	\$164.50
1177-LE	186	6	\$137.30	530	227	1	\$5.50	80285-LE60-AD0	159	4	\$491.80
1178-A	186	6	\$167.50	6056	195	8	\$86.50	80285-LE60-AD1	159	4	\$500.80
1178-DA	186	6	\$199.50	6076	195	8	\$143.00	80286-AC	179	6	\$85.50
1178-DLE	186	6	\$202.50	6086-Z	195	8	\$106.75	80287-LE60-AD0	160	4	\$551.00
1178-LE	186	6	\$171.50	61-LC	225	1	\$3.50	80287-LE60-AD1	160	4	\$560.00
1240	200	6	\$97.50	61-LU	225	1	\$2.50	80465	184	6	\$85.25
1246	201	6	\$93.50	6266	195	8	\$117.25	80466	184	6	\$74.50
1379	198	6	\$218.00	7074-L	228	1	\$18.50	80642-LE0	164	6	\$125.50
1379-L	198	6	\$152.00	714-WT-02	227	1	\$9.50	80642-LE1	164	6	\$0.00
1380	198	6	\$234.50	7255-M	228	1	\$3.00	80805	190	8	\$101.25
1380-L	198	6	\$170.50	731-K	227	1	\$23.50	80826	190	8	\$132.25
1555	203	6	\$97.00	781-A	227	1	\$15.00	80850	191	8	\$123.25
157-I	225	1	\$31.50	80045-LE60	153	4	\$458.90	80868	191	8	\$205.30
1645	202	6	\$97.60	80045-LE60-AD0	153	4	\$573.90	80868-C3	191	8	\$314.50
1645-17	202	6	\$108.00	80045-LE60-AD1	153	4	\$582.90	80868-L3	191	8	\$296.00
1645-CO	202	6	\$108.00	80047-TA3	173	6	\$147.85	80868-Z	191	8	\$174.75
1645-PR	202	6	\$100.90	80047-TLE0	173	6	\$135.85	80897	190	8	\$158.00
1645-S	202	6	\$125.90	80047-UA	173	6	\$135.50	80897-C3	190	8	\$234.00
1655	203	6	\$99.80	80047-UA1	173	6	\$144.50	80897-L3	190	8	\$222.00
1655-P	203	6	\$99.80	80047-UA3	173	6	\$150.50	80905	191	8	\$109.75
1655-X	203	6	\$103.80	80047-ULE0	173	6	\$138.50	80926	192	8	\$140.75
1655-X1817	203	6	\$122.70	80047-ULE3	173	6	\$153.50	80950	193	8	\$131.25
1665-WX	203	6	\$110.10	80047-ULE60	153	4	\$443.90	80968	193	8	\$212.40
1665-XP17	203	6	\$127.60	80047-ULE60-AD0	153	4	\$558.90	80968-Z	193	8	\$182.75
1675	202	6	\$117.20	80047-ULE60-AD1	153	4	\$567.90	80971	194	8	\$242.50
1675-S	203	6	\$138.70	80047-ULE60-AD23	153	4	\$575.40	80971-Z	194	8	\$212.50
2056-SPT1109	228	1	\$5.00	80047-ULE60-AD3	153	4	\$573.90	80997	192	8	\$166.50
2126-A	228	1	\$6.00	80048-TA	174	6	\$140.50	81125-A	187	6	\$159.50
268-TVR	226	1	\$3.00	80048-TLE0	174	6	\$135.85	81125-DA	187	6	\$189.50
2985-J	228	1	\$29.70	80048-UA	174	6	\$150.50	81137-A	185	6	\$122.50
3034-1/2-02	228	1	\$17.90	80048-ULE0	174	6	\$153.50	81137-AELS	185	6	\$142.50
3042-A	228	1	\$25.00	80048-ULE3	174	6	\$168.50	81137-DA	185	6	\$154.50
3042-P	228	1	\$8.00	80050-U-I	175	6	\$233.10	81137-DAELS	185	6	\$174.50
3061-AZ1/2	228	1	\$25.00	80050-ULERC-I	175	6	\$235.10	81137-DLE	185	6	\$157.50
3105	214	12	\$22.00	80051-ULERC	175	6	\$129.50	81137-LE	185	6	\$125.50
3105-BP	214	12	\$23.00	80054-U-I	175	6	\$245.50	81172-D12AL1	187	8	\$292.50
3106	215	12	\$44.00	80084-A	181	6	\$106.50	81172-D12AL1-BN	187	8	\$350.50
312-10N	226	1	\$15.50	80084-AELS	181	6	\$132.30	85-FW	225	1	\$1.00

## 2018 CENTRAL BRASS PRODUCT CATALOG PRICE INDEX

MODEL	PAGE	PCS/ CS	LIST PRICE	MODEL	PAGE	PCS/ CS	LIST PRICE	MODEL	PAGE	PCS/ CS	LIST PRICE
990-L	227	1	\$5.00	CS-42011	165	---	\$19.30	CS-49032	225	2	\$14.00
CS-13001C	229	1	\$20.50	CS-42012	165	---	\$11.50	CS-52001	165	---	\$6.10
CS-13001H	229	1	\$20.50	CS-42013	166	---	\$77.00	CS-53001	229	---	\$4.50
CS-13001P	229	1	\$20.50	CS-42014	166	---	\$15.40	CS-53002	229	---	\$6.00
CS-13002C	229	1	\$14.40	CS-42015	165	---	\$8.50	CS-53003	229	---	\$7.20
CS-13002H	229	1	\$14.40	CS-42016	165	---	\$27.50	CS-53004	229	---	\$9.00
CS-13003P	229	1	\$5.40	CS-42017	165	---	\$7.70	CS-63003	229	---	\$36.00
CS-13004C	229	---	\$113.30	CS-42018	166	---	\$32.00	CS-63004	229	1	\$277.00
CS-13004H	229	---	\$113.30	CS-42019	166	---	\$38.90	CS-63005	229	---	\$40.50
CS-14001C	229	1	\$45.00	CS-42020	165	---	\$11.90	CS-65001	176	24	\$60.50
CS-14001H	229	1	\$45.00	CS-42026	165	---	\$1.00	CS-65002	176	24	\$44.60
CS-14001P	229	1	\$45.00	CS-42027	165	---	\$68.20	CS-66001	204	30	\$35.50
CS-14002C	229	1	\$52.00	CS-42028	165	---	\$19.90	CS-66001-BN	204	30	\$38.50
CS-14002H	229	1	\$52.00	CS-42032	165	---	\$10.40	CS-66002	204	30	\$37.00
CS-14002P	229	1	\$52.00	CS-42033	165	---	\$24.20	CS-66002-BN	204	30	\$39.50
CS-15001	229	1	\$15.50	CS-43001	229	1	\$58.50	CS-66003	204	30	\$31.50
CS-19001C	229	1	\$31.00	CS-43005	229	---	\$9.50	CS-66003-BN	204	30	\$33.50
CS-19001H	229	1	\$31.00	CS-43006	229	---	\$9.50	CS-66004	204	30	\$32.00
CS-19002C	229	1	\$28.90	CS-43007	229	---	\$3.00	CS-66004-BN	204	30	\$35.00
CS-19002H	229	1	\$28.90	CS-43008	229	---	\$4.50	G-1043	227	1	\$10.10
CS-19003C	229	1	\$36.40	CS-43009	229	1	\$57.00	G-1043-C	227	1	\$26.60
CS-19003H	229	1	\$36.40	CS-44001	229	---	\$20.60	G-128-52	225	2	\$2.00
CS-19004C	229	1	\$33.50	CS-44002	229	1	\$4.00	G-1548-ET	227	1	\$33.00
CS-19004H	229	1	\$33.50	CS-45002	229	---	\$40.50	G-1588-CT	227	1	\$16.50
CS-19005	229	---	\$54.50	CS-45003	229	---	\$15.50	G-1748-88W	227	---	\$14.60
CS-19006	229	---	\$53.40	CS-46001	229	---	\$2.40	G-195-DST9	214	1	\$7.75
CS-19007C	165	---	\$14.10	CS-47001	229	---	\$5.50	G-2090-S	228	1	\$28.00
CS-19007H	165	---	\$14.10	CS-48001	229	---	\$19.00	G-21	225	1	\$9.50
CS-19007P	165	---	\$13.90	CS-49003	229	---	\$13.50	G-2115-TP	228	1	\$7.50
CS-22001	229	1	\$68.00	CS-49004	229	---	\$12.50	G-218-A	226	1	\$14.00
CS-22002	229	---	\$37.50	CS-49005	229	---	\$9.00	G-284	226	1	\$11.50
CS-22003	219	---	\$83.50	CS-49007	229	---	\$8.00	G-2887	228	1	\$104.00
CS-22004	217	---	\$42.20	CS-49008	229	---	\$6.50	G-29-A	225	1	\$15.10
CS-22005	217	---	\$44.00	CS-49009	229	---	\$10.50	G-3009-A	228	1	\$34.00
CS-23002	229	---	\$90.50	CS-49011	229	---	\$3.50	G-3036-A	228	1	\$61.35
CS-25001	229	1	\$32.50	CS-49012	229	---	\$4.00	G-30-C	225	1	\$13.50
CS-34001C	223	---	\$27.00	CS-49013	229	---	\$4.50	G-3113-6	228	1	\$30.50
CS-34001H	223	---	\$27.00	CS-49014	229	---	\$3.50	G-3131	228	1	\$70.00
CS-34001V	223	---	\$21.50	CS-49015	229	1	\$6.50	G-3359-A	228	1	\$14.50
CS-39001	223	1	\$9.50	CS-49016C	223	1	\$37.00	G-392	226	1	\$18.50
CS-39002	223	---	\$49.50	CS-49016H	223	1	\$37.00	G-398-C	226	1	\$8.00
CS-39003	223	---	\$66.50	CS-49016P	223	1	\$37.00	G-398-H	226	1	\$8.00
CS-39004	223	1	\$33.00	CS-49017C	223	1	\$36.50	G-4147-C	228	1	\$31.50
CS-42001	229	---	\$33.50	CS-49017H	223	1	\$36.50	G-4147-H	228	1	\$31.50
CS-42002	229	100	\$35.20	CS-49018C	229	---	\$2.00	G-4149-C	228	1	\$34.00
CS-42003	229	100	\$31.80	CS-49018H	229	---	\$2.00	G-4149-H	228	1	\$34.00
CS-42004	229	100	\$39.80	CS-49019	229	---	\$0.75	G-453-EL	223	1	\$9.50
CS-42005	165	16	\$77.80	CS-49020	229	---	\$2.00	G-453-ER	223	1	\$9.50
CS-42006	165	---	\$77.80	CS-49026	229	---	\$3.60	G-454-EL	223	1	\$10.00
CS-42010	166	---	\$12.90	CS-49027	229	---	\$3.10	G-454-ER	223	1	\$10.00

## 2018 CENTRAL BRASS PRODUCT CATALOG PRICE INDEX





MODEL	PAGE	PCS/ CS	LIST PRICE	MODEL	PAGE	PCS/ CS	LIST PRICE	MODEL	PAGE	PCS/ CS	LIST PRICE
G-458-KL	223	1	\$17.20	PF-6930	228	1	\$18.90	SU-3359-A	228	1	\$31.50
G-458-KR	223	1	\$17.20	PF-7114-P	228	1	\$41.10	SU-357-HSA	226	1	\$115.00
G-508-C	226	1	\$11.00	PF-7114-PS	228	1	\$45.30	SU-357-WSA	226	1	\$106.00
G-508-D	226	1	\$11.00	PF-7125	228	1	\$9.60	SU-358-SA	226	1	\$9.00
G-508-H	226	1	\$11.00	PF-7125-C	228	1	\$9.60	SU-363-JA	226	1	\$36.90
G-518-C	226	1	\$16.50	PF-7125-H	228	1	\$9.60	SU-363-JH	226	1	\$38.45
G-518-H	226	1	\$16.50	PF-714-RT	227	1	\$154.70	SU-363-LA	226	1	\$40.30
G-520-W	226	1	\$4.95	PF-725-A	227	1	\$50.00	SU-363-LH	226	1	\$41.90
G-521-BWD	226	1	\$8.40	PF-731-G	227	1	\$9.50	SU-363-MA	226	1	\$41.40
G-523-C	226	1	\$6.00	PF-741-DO	227	1	\$8.00	SU-363-MH	226	1	\$42.90
G-523-H	227	1	\$6.00	PF-752-T	227	1	\$36.00	SU-363-RA	226	1	\$28.70
G-5355-S	228	1	\$10.50	PF-768-D	227	1	\$8.00	SU-363-RH	226	1	\$30.30
G-6928-V	228	1	\$43.90	PF-776-D	227	1	\$10.50	SU-365-CA	226	1	\$51.50
G-7114-V	228	1	\$44.00	SU-1043-S	227	1	\$9.00	SU-365-CH	226	1	\$53.50
G-7116-V	228	1	\$43.50	SU-1109	227	1	\$38.50	SU-511-A	226	1	\$28.70
G-7233	228	1	\$35.00	SU-1548-605	223	1	\$21.50	SU-61-LC	225	1	\$8.00
G-7237	228	1	\$23.30	SU-157-DA	225	1	\$45.20	SU-61-LCPP	225	1	\$17.00
G-7237-477	228	1	\$34.50	SU-157-G	225	1	\$46.50	SU-61-LDP	225	1	\$32.00
G-756-E	227	1	\$2.50	SU-157-GLA	225	1	\$54.50	SU-61-LEP	225	1	\$31.50
G-83-ACZ	225	1	\$10.00	SU-157-GRA	225	1	\$37.50	SU-6965	228	1	\$68.00
G-83-AZ	225	1	\$22.00	SU-157-GSA	225	1	\$37.00	SU-7071	228	1	\$123.50
G-913-A	227	1	\$6.55	SU-157-HA	225	1	\$59.00	SU-7101-AF	228	1	\$10.50
G-914-SA	227	1	\$7.00	SU-157-JA	225	1	\$63.20	SU-756-CB	227	1	\$5.00
G-94-F	225	1	\$2.50	SU-157-KRA	225	1	\$83.50	SU-767	227	1	\$15.20
G-95-A	225	1	\$3.00	SU-157-KSA	225	1	\$84.00	SU-83-AZ	225	1	\$15.80
G-97	225	1	\$3.00	SU-1839-P	223	1	\$21.50	SU-85-APF	225	1	\$12.00
K-2-CT	223	1	\$32.00	SU-1839-PRC	223	1	\$23.10	SU-85-FA	225	1	\$15.00
K-2-DT	223	1	\$57.10	SU-1855-47RPRC	223	1	\$13.00	SU-85-K	225	1	\$13.00
K-351-C	223	1	\$39.50	SU-2051-P	228	1	\$13.80	SU-85-KM	225	1	\$14.00
K-351-H	223	1	\$39.50	SU-2090-A	228	1	\$123.00	SU-85-U	225	1	\$5.50
K-352-C	223	1	\$30.50	SU-2090-AB	228	1	\$122.50	T-2	197	6	\$28.60
K-352-H	223	1	\$30.50	SU-2136-FA	228	1	\$74.00	T-2-BN	197	6	\$39.50
K-361	223	1	\$40.60	SU-257-JSA	226	1	\$131.70	T-2-C3	197	6	\$109.00
K-3-CT	223	1	\$20.50	SU-257-TSA	226	1	\$92.00	T-2-C3-BN	197	6	\$115.50
K-3-DT	223	1	\$21.00	SU-266-P	226	1	\$5.50	T-2-L3	197	6	\$97.00
K-453-C	223	1	\$11.00	SU-2775-R-02	228	---	\$42.00	T-2-L3-BN	197	6	\$103.00
K-453-H	223	1	\$11.00	SU-2806	228	1	\$51.00	T-3	197	6	\$48.30
PF-1043-A	227	1	\$3.50	SU-2807	228	1	\$34.60	T-3-BN	197	6	\$63.10
PF-1090-J	227	1	\$3.50	SU-2841-ARC	228	1	\$82.00	T-3-C3	197	6	\$164.00
PF-161-D	225	1	\$8.10	SU-2841-S	228	1	\$108.00	T-3-C3-BN	197	6	\$173.00
PF-177-G	226	1	\$8.70	SU-2846	228	1	\$38.70	T-3-L3	197	6	\$145.00
PF-218-A	226	1	\$12.00	SU-2923-A	228	1	\$69.50	T-3-L3-BN	197	6	\$154.50
PF-259-X	226	1	\$14.00	SU-2924-A	228	1	\$26.50	TC-2	196	6	\$51.10
PF-263-D	226	1	\$9.70	SU-2924-H-01	228	1	\$21.50	TC-2-BN	196	6	\$83.30
PF-3359-A	228	1	\$10.00	SU-2924-H-02	228	1	\$26.50	TC-2-C3	196	6	\$193.70
PF-358-Q	226	1	\$4.00	SU-2929-01	228	1	\$36.00	TC-2-C3-BN	196	6	\$200.70
PF-358-RS	226	1	\$9.50	SU-2987-DA	228	1	\$7.50	TC-2-L3	196	6	\$180.30
PF-398-B8	226	1	\$87.00	SU-3026-B	228	1	\$41.00	TC-2-L3-BN	196	6	\$188.00
PF-5075-YP	228	1	\$6.00	SU-3026-CDL	228	1	\$23.50	TC-3	196	6	\$68.70
PF-6928-P	228	1	\$39.70	SU-3130-M	228	1	\$61.00	TC-3-BN	196	6	\$103.70

## 2018 CENTRAL BRASS PRODUCT CATALOG PRICE INDEX

MODEL	PAGE	PCS/ CS	LIST PRICE	MODEL	PAGE	PCS/ CS	LIST PRICE	MODEL	PAGE	PCS/ CS	LIST PRICE
TC-3-C3	197	6	\$240.70	X193-LBN	226	6	\$1.50	X848-B	227	10	\$3.50
TC-3-C3-BN	197	6	\$251.45	X194	226	6	\$1.00	X85-U	225	2	\$2.00
TC-3-L3	197	6	\$229.80	X195-C	226	6	\$2.00	X901-WNN	227	25	\$3.50
TC-3-L3-BN	197	6	\$232.20	X207-B	226	6	\$2.50	X904-N	227	6	\$1.65
TCR-2	196	6	\$61.10	X2133-210	228	2	\$49.20	X913-N	227	10	\$2.00
TCR-2-BN	196	6	\$93.30	X218-B	226	10	\$6.50	X936-A	227	6	\$4.50
TCR-3	196	6	\$78.70	X218-C	226	10	\$4.00	X940	227	10	\$3.00
TCR-3-BN	196	6	\$113.70	X218-F	226	2	\$6.50	X940-TRN	227	10	\$3.50
TR-2	197	6	\$39.60	X22	225	6	\$2.00	X944-N	227	2	\$1.50
TR-2-BN	197	6	\$49.50	X222-D	226	6	\$2.00	X945	227	2	\$3.50
TR-3	197	6	\$58.30	X263-BC	226	10	\$13.50	X947-C	227	10	\$4.00
TR-3-BN	197	6	\$73.10	X269-29/16	226	10	\$29.50	X954-AN	227	10	\$2.00
U-1615-50RC	227	1	\$110.30	X279-D	226	10	\$2.50	X977	227	10	\$4.50
U-1615-54-02	227	1	\$186.50	X279-E	226	10	\$4.00	X991	227	4	\$3.00
U-1615-54-04	227	1	\$139.00	X279-L	226	10	\$1.75	X991-A	227	4	\$7.00
U-2170-AL	228	1	\$61.50	X279-V	226	10	\$3.00	X991-C	227	4	\$3.50
U-2170-AR	228	1	\$61.50	X28-A	225	6	\$2.25	XCS-42021	165	---	\$6.50
U-2171-A	228	1	\$38.00	X3	225	6	\$4.00	XCS-42022	165	---	\$2.50
X1009-A	227	2	\$12.00	X3008-X	228	2	\$6.00	XCS-42023	165	---	\$4.70
X1028-Y	227	25	\$2.50	X33-A	225	6	\$2.00	XCS-42025	165	---	\$4.70
X1038-453	227	25	\$4.00	X358-U	226	10	\$1.50	XCS-42029	165	---	\$19.00
X1038-IN	227	10	\$3.50	X358-V	226	10	\$4.50	XCS-44002	230	10	\$38.00
X1038-KN	227	25	\$7.00	X4	225	6	\$4.00	XCS-45004	230	---	\$5.00
X1038-W	227	10	\$4.00	X402-A	226	25	\$2.00	XCS-45005	230	---	\$2.50
X103-HS	225	6	\$2.00	X402-B	226	12	\$4.00	XCS-45006	230	---	\$1.00
X103-HSSS	225	6	\$2.00	X4079-3/8	228	1	\$11.50	XCS-45007	230	---	\$1.00
X103-PLCP	225	6	\$3.00	X409-PT	226	12	\$4.00	XCS-47001	165	---	\$15.00
X104	225	25	\$3.00	X42	225	6	\$3.50	XCS-49001	230	---	\$1.00
X1043-B	227	6	\$4.00	X420-N	226	12	\$2.00	XCS-49002	230	---	\$2.00
X1043-FN	227	2	\$1.50	X427-WS	226	12	\$7.00	XCS-49033	165	---	\$2.90
X1043-T	227	6	\$2.50	X433-AN	226	12	\$6.00	XCS-53005	230	---	\$2.00
X105	225	25	\$3.00	X491-S	226	12	\$10.50	XG-1867-ALCP	227	2	\$17.50
X105-H	225	6	\$3.00	X491-U	226	12	\$7.50	XPF-166-U	226	2	\$7.00
X107-F	225	25	\$4.50	X4-L	225	6	\$2.00	XPF-263-B	226	4	\$5.00
X107-FB	225	5	\$3.00	X4-MA	225	6	\$2.00	XPF-263-C	226	2	\$6.00
X107-FR	225	5	\$3.00	X4-N	225	6	\$1.50	XPF-59	225	10	\$13.00
X107-H	225	6	\$3.00	X53-AS	225	6	\$7.00	XPF-67-AC	225	10	\$5.00
X1081-N	227	10	\$2.00	X53-AZ	225	6	\$6.90	XPF-782-D	227	2	\$6.00
X113-P	225	6	\$1.00	X53-CZ	225	6	\$7.50	XPF-784-C	227	2	\$6.00
X126-S	225	6	\$0.75	X54	225	10	\$3.00	XSU-1548-BSP	227	2	\$36.50
X127-AP21/4	225	6	\$6.50	X68-HX	225	10	\$8.00	XSU-1858-A	223	2	\$22.50
X1549	227	2	\$19.50	X69-C	225	10	\$3.00	XSU-233-B	226	2	\$12.10
X165	226	10	\$13.00	X700-KT	227	2	\$14.10				
X165-6500	226	2	\$5.00	X70-WA	225	6	\$6.25				
X166-FN	226	6	\$1.00	X71	225	2	\$13.50				
X166-Q	226	6	\$2.00	X7133-AZ	228	10	\$7.00				
X168-B	226	4	\$3.00	X765-TA	227	6	\$9.00				
X1875	227	2	\$6.00	X809	227	10	\$2.50				
X1875-C	227	2	\$6.00	X814-BARP	227	10	\$10.00				
X1876-BB	227	2	\$9.00	X82-J	225	6	\$2.00				



# KITCHEN // Pre-Rinse Faucets

## PRE-RINSE FAUCETS

	Model#	Description	Finish	Case	Price	
 <p>Shown With Add-On Spout</p>		<b>0045-LE60</b> Two Handle Ledge Pre-Rinse Faucet 2-3/8" Lever Handle 24" Quick Install Riser With Spring Guide 44" Flexible Stainless Steel Hose Replaceable Seats Back Flow Preventers 1/2-14 NPS Female Thread 1.1 GPM Flow Rate Spray Valve 2-Hole 8" Installation Pipe Strap and Hook Assembly	Polished Chrome	4	\$448.90	
		<b>80045-LE60</b> Ceramic Disc Cartridges	Polished Chrome	4	\$458.90	
		<b>The same as 0045-LE60 with:</b>				
		<b>0045-LE60-AD0</b> Secondary Control Valve Add-On Faucet 6" Swivel Tube Spout - 1.5 GPM Flow Rate	Polished Chrome	4	\$563.90	
		<b>80045-LE60-AD0</b> Secondary Control Valve Add-On Faucet 6" Swivel Tube Spout - 1.5 GPM Flow Rate Ceramic Disc Cartridges	Polished Chrome	4	\$573.90	
	<b>80045-LE60-AD1</b> Secondary Control Valve Add-On Faucet 8" Swivel Tube Spout - 1.5 GPM Flow Rate Ceramic Disc Cartridges	Polished Chrome	4	\$582.90		
 <p>Shown Less Add-On Spout</p>		<b>0047-ULE60</b> Two Handle Wallmount Pre-Rinse Faucet 2-3/8" Lever Handle 24" Quick Install Riser With Spring Guide 44" Flexible Stainless Steel Hose Replaceable Seats Back Flow Preventers 1/2-14 NPS Female Thread 1.1 GPM Flow Rate Spray Valve 2-Hole 7-7/8" to 8-1/8" Installation Pipe Strap and Hook Assembly	Polished Chrome	4	\$433.90	
		<b>80047-ULE60</b> Ceramic Disc Cartridges	Polished Chrome	4	\$443.90	
		<b>The same as 0047-ULE60 with:</b>				
		<b>0047-ULE60-AD0</b> Secondary Control Valve Add-On Faucet 6" Swivel Tube Spout 1.5 GPM Flow Rate	Polished Chrome	4	\$548.90	
		<b>0047-ULE60-AD1</b> Secondary Control Valve Add-On Faucet 8" Swivel Tube Spout 1.5 GPM Flow Rate	Polished Chrome	4	\$557.90	
		<b>80047-ULE60-AD0</b> Secondary Control Valve Add-On Faucet 6" Swivel Tube Spout Ceramic Disc Cartridges 1.5 GPM Flow Rate	Polished Chrome	4	\$558.90	
		<b>80047-ULE60-AD1</b> Secondary Control Valve Add-On Faucet 8" Swivel Tube Spout Ceramic Disc Cartridges 1.5 GPM Flow Rate	Polished Chrome	4	\$567.90	
		<b>80047-ULE60-AD3</b> Secondary Control Valve Add-On Faucet 12" Swivel Tube Spout Ceramic Disc Cartridges 1.5 GPM Flow Rate	Polished Chrome	4	\$573.90	
<b>80047-ULE60-AD23</b> Secondary Control Valve Add-On Faucet 18" Swivel Tube Spout Ceramic Disc Cartridges 1.5 GPM Flow Rate	Polished Chrome	4	\$575.40			

# KITCHEN // Pre-Rinse Faucets

PRE-RINSE FAUCETS







	Model#	Description	Finish	Case	Price
	0045-LE61	Two Handle Ledge Pre-Rinse Faucet 2-3/8" Lever Handle Overhead Swivel 12" Reach and 27-3/4" High Arm 26" Flexible Stainless Steel Hose Replaceable Seats Back Flow Preventers 1/2-14 NPS Female Thread 1.1 GPM Flow Rate Spray Valve 2-Hole 8" Installation Pipe Strap and Hook Assembly	Polished Chrome	4	\$477.10
	0047-ULE61	Two Handle Wallmount Pre-Rinse Faucet 2-3/8" Lever Handle Overhead Swivel 12" Reach and 27-3/4" High Arm 26" Flexible Stainless Steel Hose Replaceable Seats Back Flow Preventers 1/2-14 NPS Female Thread 1.1 GPM Flow Rate Spray Valve 2-Hole 7-7/8" to 8-1/8" Installation Pipe Strap and Hook Assembly	Polished Chrome	4	\$441.70

Central Brass faucets feature sprayheads that meet ANSI/ASME A112.18.1 flow requirements of 1.1 GPM

KITCHEN

# KITCHEN // Pre-Rinse Faucets







## PRE-RINSE FAUCETS

	Model#	Description	Finish	Case	Price	
 <p>Shown Less Add-On Spout</p>	 	<b>0084-LE60</b> Two Handle Cast Brass Pre-Rinse Faucet 2-3/8" Lever Handle 24" Quick Install Riser With Spring Guide 44" Flexible Stainless Steel Hose Replaceable Seats Back Flow Preventers 1.1 GPM Flow Rate Spray Valve 2 or 3-Hole 4" Installation Pipe Strap and Hook Assembly	Polished Chrome	4	\$472.20	
		<b>80084-LE60</b> Ceramic Disc Cartridges	Polished Chrome	4	\$482.20	
	<b>The same as 0084-LE60 with:</b>					
		<b>0084-LE60-AD0</b> Secondary Control Valve Add-On Faucet 6" Swivel Tube Spout 1.5 GPM Flow Rate	Polished Chrome	4	\$587.20	
		<b>80084-LE60-AD0</b> Secondary Control Valve Add-On Faucet 6" Swivel Tube Spout Ceramic Disc Cartridges 1.5 GPM Flow Rate	Polished Chrome	4	\$597.20	
	<b>80084-LE60-AD1</b> Secondary Control Valve Add-On Faucet 8" Swivel Tube Spout Ceramic Disc Cartridges 1.5 GPM Flow Rate	Polished Chrome	4	\$606.20		
	 	<b>0122-LE60</b> Two Handle Cast Brass Pre-Rinse Faucet 2-3/8" Lever Handle 24" Quick Install Riser With Spring Guide 44" Flexible Stainless Steel Hose Replaceable Seats Back Flow Preventers 1.1 GPM Flow Rate Spray Valve 3-Hole 8" Installation Pipe Strap and Hook Assembly	Polished Chrome	4	\$474.00	

Central Brass faucets feature sprayheads that meet ANSI/ASME A112.18.1 flow requirements of 1.1 GPM

# KITCHEN // Pre-Rinse Faucets



PRE-RINSE FAUCETS

	Model#	Description	Finish	Case	Price
	  <b>0084-LE61</b>	Two Handle Pre-Rinse Faucet 2-3/8" Lever Handle Overhead Swivel 12" Reach and 27-3/4" High Arm 26" Flexible Stainless Steel Hose Replaceable Seats Back Flow Preventers 1.1 GPM Flow Rate Spray Valve 2 or 3-Hole 4" Installation Pipe Strap and Hook Assembly	Polished Chrome	4	\$520.60
	  <b>0122-LE61</b>	Two Handle Cast Brass Pre-Rinse Faucet 2-3/8" Lever Handle Overhead Swivel 12" Reach and 27-3/4" High Arm 26" Flexible Stainless Steel Hose Replaceable Seats Back Flow Preventers 1.1 GPM Flow Rate Spray Valve 3-Hole 8" Installation Pipe Strap and Hook Assembly	Polished Chrome	4	\$505.10

Central Brass faucets feature sprayheads that meet ANSI/ASME A112.18.1 flow requirements of 1.1 GPM

# KITCHEN // Pre-Rinse Faucets



## PRE-RINSE FAUCETS

	Model#	Description	Finish	Case	Price
 <p>Shown Less Add-On Spout</p>	0184-LE60	Two Handle Cast Brass Wallmount Pre-Rinse Faucet 2-3/8" Lever Handle 24" Quick Install Riser With Spring Guide 44" Flexible Stainless Steel Hose Replaceable Seats Back Flow Preventers 1.1 GPM Flow Rate Spray Valve 2-Hole 4" Installation Pipe Strap and Hook Assembly	Polished Chrome	4	\$484.80
	<b>The same as 0184-LE60 with:</b>				
	0184-LE60-AD0	Secondary Control Valve Add-On Faucet 6" Swivel Tube Spout 1.5 GPM Flow Rate	Polished Chrome	4	\$600.80
 <p>Shown With Add-On Spout</p>	0194-LE60	Two Handle Shell Type Wallmount Pre-Rinse Faucet 2-3/8" Lever Handle 24" Quick Install Riser With Spring Guide 44" Flexible Stainless Steel Hose Replaceable Seats Back Flow Preventers 1.1 GPM Flow Rate Spray Valve 2-Hole 4" Installation Pipe Strap and Hook Assembly	Polished Chrome	4	\$435.10
	<b>The same as 0194-LE60 with:</b>				
	0194-LE60-AD0	Secondary Control Valve Add-On Faucet 6" Swivel Tube Spout 1.5 GPM Flow Rate	Polished Chrome	4	\$550.10

Central Brass faucets feature sprayheads that meet ANSI/ASME A112.18.1 flow requirements of 1.1 GPM

# KITCHEN // Pre-Rinse Faucets





PRE-RINSE FAUCETS

	Model#	Description	Finish	Case	Price
	0184-LE61	Two Handle Cast Brass Wallmount Pre-Rinse Faucet 2-3/8" Lever Handle Overhead Swivel 12" Reach and 27-3/4" High Arm 26" Flexible Stainless Steel Hose Replaceable Seats Back Flow Preventers 1.1 GPM Flow Rate Spray Valve 2-Hole 4" Installation Pipe Strap and Hook Assembly	Polished Chrome	4	\$534.20
	0194-LE61	Two Handle Shell Type Wallmount Pre-Rinse Faucet 2-3/8" Lever Handle Overhead Swivel 12" Reach and 27-3/4" High Arm 26" Flexible Stainless Steel Hose Replaceable Seats Back Flow Preventers 1.1 GPM Flow Rate Spray Valve 2-Hole 4" Installation Pipe Strap and Hook Assembly	Polished Chrome	4	\$483.50

Central Brass faucets feature sprayheads that meet ANSI/ASME A112.18.1 flow requirements of 1.1 GPM

# KITCHEN // Pre-Rinse Faucets



## PRE-RINSE FAUCETS

	Model#	Description	Finish	Case	Price
	 0280-LE60	Single Handle Pre-Rinse Faucet 2-3/4" Lever Handle 24" Quick Install Riser With Spring Guide 44" Flexible Stainless Steel Hose Replaceable Seat Back Flow Preventers 1/2-14 NPS Male inlet x 1-7/8" Long 1.1 GPM Flow Rate Spray Valve 1-Hole Installation Pipe Strap and Hook Assembly	Polished Chrome	4	\$366.80
  Shown Less Add-On Spout	 0285-LE60-AD0-Q	Two Handle Pre-Rinse Faucet 2-3/8" Lever Handle 24" Quick Install Riser With Spring Guide 44" Flexible Stainless Steel Hose Quick-Pression Quarter-Turn Stems Replaceable Seats Back Flow Preventers Easy-Install 30" Flex Supply Lines With 3/8" Connections 1.1 GPM Flow Rate Spray Valve 1-Hole Installation Pipe Strap and Hook Assembly Secondary Control Valve Add-On Faucet 6" Swivel Tube Spout 1.1 GPM Flow Rate	Polished Chrome	4	\$481.80
	<b>The same as 0285-LE60-Q with:</b>				
	80285-LE60-AD0	Ceramic Disc Cartridges	Polished Chrome	4	\$491.80
	80285-LE60-AD1	8" Swivel Tube Spout Ceramic Disc Cartridges 1.1 GPM Flow Rate	Polished Chrome	4	\$500.80

Central Brass faucets feature sprayheads that meet ANSI/ASME A112.18.1 flow requirements of 1.1 GPM

# KITCHEN // Pre-Rinse Faucets







PRE-RINSE FAUCETS

	Model#	Description	Finish	Case	Price	
 <p>Shown With Add-On Spout</p>	 <b>0287-LE60-Q</b>	Two Handle Pre-Rinse Faucet 2-3/8" Lever Handle 24" Quick Install Riser With Spring Guide 44" Flexible Stainless Steel Hose Quick-Pression Quarter-Turn Stems Replaceable Seats Back Flow Preventers Easy-Install 30" Flex Supply Lines With 3/8" Connections 1.1 GPM Flow Rate Spray Valve 1-Hole Installation Pipe Strap and Hook Assembly	Polished Chrome	4	\$426.00	
	<b>The same as 0287-LE60-Q with:</b>					
	<b>0287-LE60-AD0-Q</b>	Secondary Control Valve Add-On Faucet 6" Swivel Tube Spout 1.1 GPM Flow Rate	Polished Chrome	4	\$541.00	
	<b>80287-LE60-AD0</b>	Secondary Control Valve Add-On Faucet 6" Swivel Tube Spout Ceramic Disc Cartridges 1.1 GPM Flow Rate	Polished Chrome	4	\$551.00	
<b>80287-LE60-AD1</b>	Secondary Control Valve Add-On Faucet 8" Swivel Tube Spout Ceramic Disc Cartridges 1.1 GPM Flow Rate	Polished Chrome	4	\$560.00		

Central Brass faucets feature sprayheads that meet ANSI/ASME A112.18.1 flow requirements of 1.1 GPM

# KITCHEN // Pre-Rinse Faucets







PRE-RINSE FAUCETS

	Model#	Description	Finish	Case	Price
	 	<p><b>0285-LE61-Q</b></p> <p>Two Handle Pre-Rinse Faucet                  2-3/8" Lever Handle                  Overhead Swivel 12" Reach and 27-3/4" High Arm                  26" Flexible Stainless Steel Hose                  Quick-Pression Quarter-Turn Stems                  Replaceable Seats                  Back Flow Preventers                  Easy-Install 30" Flex Supply Lines With 3/8" Connections                  1.1 GPM Flow Rate Spray Valve                  1-Hole Installation                  Pipe Strap and Hook Assembly</p>	<p>Polished Chrome</p>	<p>4</p>	<p>\$454.50</p>
	 	<p><b>0287-LE61-Q</b></p> <p>Two Handle Pre-Rinse Faucet                  2-3/8" Lever Handle                  Overhead Swivel 12" Reach and 27-3/4" High Arm                  26" Flexible Stainless Steel Hose                  Quick-Pression Quarter-Turn Stems                  Replaceable Seats                  Back Flow Preventers                  Easy-Install 30" Flex Supply Lines With 3/8" Connections                  1.1 GPM Flow Rate Spray Valve                  1-Hole Installation                  Pipe Strap and Hook Assembly</p>	<p>Polished Chrome</p>	<p>4</p>	<p>\$466.50</p>

Central Brass faucets feature sprayheads that meet ANSI/ASME A112.18.1 flow requirements of 1.1 GPM

# KITCHEN // Pre-Rinse Faucets

PRE-RINSE FAUCETS





	Model#	Description	Finish	Case	Price
	  <b>0650-60</b>	Single Handle Pre-Rinse Faucet Lever Handle 24" Quick Install Riser With Spring Guide 44" Flexible Stainless Steel Hose Ceramic Disc Cartridge With Temperature Limit Stop Back Flow Preventers Easy-Install 30" Flex Supply Lines With 3/8" Connections 1.1 GPM Flow Rate Spray Valve 2-Hole 4" to 6" Installation Pipe Strap and Hook Assembly	Polished Chrome	4	\$428.90
	  <b>0650-60-AD0</b>	Single Handle Pre-Rinse Faucet Lever Handle 24" Quick Install Riser With Spring Guide 44" Flexible Stainless Steel Hose Ceramic Disc Cartridge With Temperature Limit Stop Back Flow Preventers Easy-Install 30" Flex Supply Lines With 3/8" Connections 1.1 GPM Flow Rate Spray Valve 2-Hole 4" to 6" Installation Pipe Strap and Hook Assembly Secondary Control Valve Add-On Faucet 6" Swivel Tube Spout 1.1 GPM Flow Rate	Polished Chrome	4	\$543.90

Central Brass faucets feature sprayheads that meet ANSI/ASME A112.18.1 flow requirements of 1.1 GPM

KITCHEN

# KITCHEN // Pre-Rinse Faucets



## PRE-RINSE FAUCETS

	Model#	Description	Finish	Case	Price
	 0640	Pre-Rinse Assembly 24" Quick Install Riser With Spring Guide 44" Flexible Stainless Steel Hose Back Flow Preventers Quick Install Adapters to retrofit on T&S, Chicago Faucets, and Fisher 1.1 GPM Flow Rate Spray Valve Pipe Strap and Hook Assembly	Polished Chrome	4	\$343.20
	 0641	Pre-Rinse Assembly Overhead Swivel 12" Reach and 27-3/4" High Arm 26" Flexible Stainless Steel Hose Back Flow Preventers Quick Install Adapters to retrofit on T&S, Chicago Faucets, and Fisher 1.1 GPM Flow Rate Spray Valve Pipe Strap and Hook Assembly	Polished Chrome	4	\$387.20

Central Brass faucets feature sprayheads that meet ANSI/ASME A112.18.1 flow requirements of 1.1 GPM

# KITCHEN // Pre-Rinse Faucets

PRE-RINSE FAUCETS

		Model#	Description	Finish	Case	Price
		0642-LE0	Add-On Faucet 2-3/8" Lever Handle Replaceable Seats 6" Swivel Tube Spout 1.5 GPM Flow Rate	Polished Chrome	6	\$115.00
		80642-LE0	Add-On Faucet 2-3/8" Lever Handle Ceramic Disc Cartridge Replaceable Seats 6" Swivel Tube Spout 1.5 GPM Flow Rate	Polished Chrome	6	\$125.50
<b>Suffix #</b>						
		1	8" Swivel Tube Spout with Aerator (SU-363-RA)		---	\$9.00
		2	10" Swivel Tube Spout with Aerator (SU-363-JA)		---	\$14.00
		3	12" Swivel Tube Spout with Aerator (SU-363-LA)		---	\$15.00
		4	14" Swivel Tube Spout with Aerator (SU-363-MA)		---	\$15.50
		6	8" Brass Swivel D-Spout with Aerator (SU-365-CA)		---	\$16.00
		07	8-3/4" Swivel Gooseneck Spout with Aerator (SU-357-WSA)		---	\$32.30
		8	7-1/4" High-Rise Spout with Aerator (SU-357-HSA)		---	\$43.30
		9	5" Cast Brass Spout With Aerator (SU-2923-A)		---	\$21.30
		13	16" Swivel Tube Spout With Aerator (CS-22004)		---	\$16.00
		17	4-3/32" Rigid/Swivel Combo Gooseneck Spout With Aerator (CS-22002)		---	\$15.50
		18	5-1/2" Rigid/Swivel Combo Gooseneck Spout With Aerator (CS-22003)		---	\$35.30
		23	18" Swivel Tube Spout With Aerator (CS-22005)		---	\$16.50
		EX	7" Cast Brass Spout Extension (SU-2775-R-02)		---	\$15.00
		F	Full Flow Streamer (CS-49029)		---	\$3.00
		GRA*	4-3/32" Rigid Gooseneck Spout With Aerator (SU-157-GRA)		---	\$15.50
		GSA*	4-3/32" Swivel Gooseneck Spout With Aerator (SU-157-GSA)		---	\$15.50
		KRA*	5-1/2" Rigid Gooseneck Spout With Aerator (SU-157-KRA)		---	\$34.80
		KSA*	4-1/2" Swivel Gooseneck Spout With Aerator (SU-157-KSA)		---	\$35.30



\* Obsolete once stock is depleted

# KITCHEN // Pre-Rinse Faucets

## PRE-RINSE FAUCETS

	Model#	Description	Finish	Pack	Price
<b>PARTS</b>	CS-42011	Drain Adapter 2" Female to 1-1/2" Male	---	---	\$19.30
	CS-42012	Drain Adapter 1-1/2" Male to 1-1/2" Male	---	---	\$11.50
	CS-42015	Hose Adapter With Check Valve	---	---	\$8.50
	CS-42016	Spring Body	Polished Chrome	---	\$27.50
	CS-42017	Finger Hook and Screw	Polished Chrome	---	\$7.70
	CS-42020	Body Adapter	---	---	\$11.90
	XCS-42021	Friction Brass Washer	---	6	\$6.50
	XCS-42022	Body Adapter Washer	---	10	\$2.50
	XCS-42023	Hose Adapter Washer	---	10	\$4.70
	XCS-47001	10 mm Check Valve	---	2	\$15.00
	XCS-42025	Hose Washer	---	10	\$4.70
	CS-42026	1/4" Allen Wrench	---	---	\$1.00
	CS-42027	20" Flexible Stainless Steel Hose	---	---	\$68.20
	CS-42028	Adapter Package	Chrome	---	\$19.90
	XCS-42029	15 mm Check Valve	---	5	\$19.00
	CS-42032	Escutcheon	---	---	\$10.40
	CS-42033	Shank and Flange Assembly	Polished Chrome	---	\$24.20
	XCS-49033	1/8" Allen Screw	---	10	\$2.90
CS-52001	Mounting Kit	---	---	\$6.10	

## PRE-RINSE FAUCET ACCESSORIES

	Model#	Description	Finish	Case	Price
	CS-19007C	Lever Handle With Vandal Proof Screw-Cold	Polished Chrome	---	\$14.10
	CS-19007H	Lever Handle With Vandal Proof Screw-Hot	Polished Chrome	---	\$14.10
	CS-19007P	Lever Handle With Vandal Proof Screw-Plain	Polished Chrome	---	\$13.90
	CS-42005	Pre-rinse Spray Integrated Stainless Steel Clip to Hold Handle Open One Piece Stainless Steel Nozzle Rubber Nozzle Bumper Serviceable Components Chrome Plate Handle with PVC Coating for Heat Resistance Brass Valve Stem with stainless Steel Spring 1.6 GPM Flow Rate Forged Brass Valve Body	Polished Chrome	---	\$77.80
	CS-42006	Pre-rinse Spray Integrated Stainless Steel Clip to Hold Handle Open One Piece Stainless Steel Nozzle Rubber Nozzle Bumper Serviceable Components Chrome Plate Handle with PVC Coating for Heat Resistance Brass Valve Stem with stainless Steel Spring 1.1 GPM Flow Rate Forged Brass Valve Body	Polished Chrome	---	\$77.80
 Shown w/ CS-42011 Adapter	0660	Waste Drain Valve Twist Handle 2" Drain, Optional adapter available for 1-1/2" Drain Rough Chrome Plated Body Twist Handle with Heat Resistant Plastic Grip 3-1/2" Snap-in removable Strainer Overflow Outlet & Cap	Polished Chrome	---	\$93.90



# KITCHEN // Pre-Rinse Accessories

## PRE-RINSE FAUCET ACCESSORIES

	Model#	Description	Finish	Case	Price
 Shown w/ CS-42011 Adapter	0661	Waste Drain Valve Lever Handle 2" Drain, Optional Adapter Available for 1-1/2" Drain Rough Chrome Plated Body Lever Handle with Heat Resistant Plastic Grip 3-1/2" Snap-in Removable Strainer Overflow Outlet & Cap	Polished Chrome	---	\$92.10
	CS-42010	Spray Repair Kit	---	---	\$12.90
	CS-42013	44" Flexible Stainless Steel Hose	---	---	\$77.00
	CS-42014	Overhead Spring	Polished Chrome	---	\$15.40
	CS-42017	Finger Hook and Screw	Polished Chrome	---	\$7.70
	CS-42018	12" Adjustable Wall Bracket	Polished Chrome	---	\$32.00
	CS-42019	24" Riser	Polished Chrome	---	\$38.90

# KITCHEN // Single Handle Faucets

## SINGLE HANDLE KITCHEN FAUCETS





	Model#	Description	Finish	Case	Price
 <p>Shown Less Spout</p>		<b>0650-0</b> Single Handle Kitchen Faucet Lever Handle 6" Tube Swivel Spout Ceramic Disc Cartridge With Temperature Limit Stop 2-Hole 4" to 6" Installation Easy-Install 30" Flex Supply Lines With 3/8" Connections 1.5 GPM Flow Rate	Polished Chrome	---	\$120.00
	<b>2</b>	10-Inch Tube Spout with Aerator (SU-363-JA)		---	\$14.00
	<b>3</b>	12-Inch Tube Spout with Aerator (SU-363-LA)		---	\$15.00
	<b>4</b>	14-Inch Tube Spout with Aerator (SU-363-MA)		---	\$15.50
	<b>8</b>	7-1/4-Inch High-Rise Spout with Aerator (SU-357-HSA)		---	\$43.30
	<b>07</b>	8-3/4-Inch High-Rise Swivel Gooseneck Spout with Aerator (SU-357-WSA)		---	\$32.30
	<b>17</b>	4-3/32" Rigid/Swivel Combo Gooseneck Spout With Aerator (CS-22002)		---	\$15.50
	<b>18</b>	5-1/2" Rigid/Swivel Combo Gooseneck Spout With Aerator (CS-22003)		---	\$35.30
	<b>GRA*</b>	4-3/32-Inch Rigid Gooseneck Spout with Aerator (SU-157-GRA)		---	\$15.50
	<b>GSA*</b>	4-3/32-Inch Swivel Gooseneck Spout with Aerator (SU-157-GSA)		---	\$15.50
	<b>KRA*</b>	5-1/2-Inch Rigid Gooseneck Spout with Aerator (SU-157-KRA)		---	\$34.80
	<b>KSA*</b>	5-1/2-Inch Swivel Gooseneck Spout with Aerator (SU-157-KSA)		---	\$35.30
	<b>ELS</b>	4-Inch Wrist Handles (G-4147-C,H) Color-coded Indexes		---	\$25.80
	<b>EL</b>	6-Inch Elbow Handles (G-4149-C,H) Color-coded Indexes		---	\$31.00
	<b>Q</b>	Quarter-Turn Stems (G-454-EL,ER)		---	\$1.80
	<b>TSA1</b>	6-3/8-Inch Swivel Tri-Arc Gooseneck Spout with Aerator (CS-22001)		---	\$29.00
	<b>L2</b>	Lever Handles-Indexes (CS-19002C,H)		---	\$53.80
	<b>C2</b>	Cross Handles-Indexes (CS-19004C,H)		---	\$64.50
	<b>E1.0</b>	1.0 GPM Flow Rate (CS-49011-Male Aerator/CS-49012-Female Aerator)		---	\$4.00
	<b>E0.5</b>	0.5 GPM Flow Rate (CS-49009-Male Aerator/CS-49010-Female Aerator)		---	\$9.50

\*Obsolete once stock is depleted. Replaced with Suffix (17,18)

Central Brass faucets feature aerators that meet ANSI/ASME A112.18.1 flow requirements of 1.5 GPM

# KITCHEN // Two Handle Faucets

## TWO HANDLE KITCHEN FAUCETS

	Model#	Description	Finish	Case	Price
	0122-LE1	Two Handle Cast Brass Kitchen Faucet 2-3/8" Lever Handles 8" Tube Swivel Spout Replaceable Seats 3-Hole 8" Installation 1.5 GPM Flow Rate	Polished Chrome	6	\$132.00
	0120-A	Canopy Handles	Polished Chrome	6	\$129.00
	0123-LE1	Two Handle Cast Brass Kitchen Faucet 2-3/8" Lever Handles 8" Tube Swivel Spout Replaceable Seats 4-Hole 8" Installation Side Spray Assembly 1.5 GPM Flow Rate	Polished Chrome	6	\$147.00
	0121-A	Canopy Handles	Polished Chrome	6	\$144.00
	0122-LE6	Two Handle Cast Brass Kitchen Faucet 2-3/8" Lever Handles 8" D Style Swivel Spout Replaceable Seats 3-Hole 8" Installation 1.5 GPM Flow Rate	Polished Chrome	6	\$142.00
	0122-A	Canopy Handles	Polished Chrome	6	\$139.00
	80122-A	Ceramic Disc Cartridges	Polished Chrome	6	\$149.50
	0123-LE6	Two Handle Cast Brass Kitchen Faucet 2-3/8" Lever Handles 8" D Style Swivel Spout Replaceable Seats 4-Hole 8" Installation Side Spray Assembly 1.5 GPM Flow Rate	Polished Chrome	6	\$157.00
	0123-A	Canopy Handles	Polished Chrome	6	\$154.00
	80123-A	Ceramic Disc Cartridges	Polished Chrome	6	\$164.50
<b>Suffix #</b>	2	10-Inch Tube Spout with Aerator (SU-363-JA)		---	\$14.00
	3	12-Inch Tube Spout with Aerator (SU-363-LA)		---	\$15.00
	4	14-Inch Tube Spout with Aerator (SU-363-MA)		---	\$15.50
	8	7-1/4-Inch High-Rise Spout with Aerator (SU-357-HSA)		---	\$43.30
	07	8-3/4-Inch High-Rise Swivel Gooseneck Spout with Aerator (SU-357-WSA)		---	\$32.30
	17	4-3/32" Rigid/Swivel Combo Gooseneck Spout With Aerator (CS-22002)		---	\$15.50
	18	5-1/2" Rigid/Swivel Combo Gooseneck Spout With Aerator (CS-22003)		---	\$35.30
	GRA*	4-3/32-Inch Rigid Gooseneck Spout with Aerator (SU-157-GRA)		---	\$15.50
	GSA*	4-3/32-Inch Swivel Gooseneck Spout with Aerator (SU-157-GSA)		---	\$15.50
	KRA*	5-1/2-Inch Rigid Gooseneck Spout with Aerator (SU-157-KRA)		---	\$34.80
	KSA*	5-1/2-Inch Swivel Gooseneck Spout with Aerator (SU-157-KSA)		---	\$35.30
	ELS	4-Inch Wrist Handles (G-4147-C,H) Color-coded Indexes		---	\$25.80
	EL	6-Inch Elbow Handles (G-4149-C,H) Color-coded Indexes		---	\$31.00
	Q	Quarter-Turn Stems (G-454-EL,ER)		---	\$1.80
	TSA1	6-3/8-Inch Swivel Tri-Arc Gooseneck Spout with Aerator (CS-22001)		---	\$29.00
	L2	Lever Handles-Indexes (CS-19002C,H)		---	\$53.80
	C2	Cross Handles-Indexes (CS-19004C,H)		---	\$64.50
	E1.0	1.0 GPM Flow Rate (CS-49011-Male Aerator/CS-49012-Female Aerator)		---	\$4.00
	E0.5	0.5 GPM Flow Rate (CS-49009-Male Aerator/CS-49010-Female Aerator)		---	\$9.50

\*Obsolete once stock is depleted. Replaced with Suffix (17,18)

Central Brass faucets feature aerators that meet ANSI/ASME A112.18.1 flow requirements of 1.5 GPM

# KITCHEN // Two Handle Faucets















## TWO HANDLE KITCHEN FAUCETS

	Model#	Description	Finish	Case	Price
	0122-GSAELS	Two Handle Cast Brass Kitchen Faucet 4" Wrist Blade Handles with Color-Coded Indexes 4-3/32" Gooseneck Swivel Spout Replaceable Seats 3-Hole 8" Installation 1.5 GPM Flow Rate	Polished Chrome	6	\$180.30
	80122-GSAELS	Ceramic Disc Cartridges	Polished Chrome	6	\$190.80

Central Brass faucets feature aerators that meet ANSI/ASME A112.18.1 flow requirements of 1.5 GPM

# KITCHEN // Two Handle Faucets

## TWO HANDLE KITCHEN FAUCETS

		Model#	Description	Finish	Case	Price
		0127-LE1	Two Handle Cast Brass Kitchen Faucet 2-3/8" Lever Handle 8" Tube Swivel Spout Replaceable Seats 3-Hole 6" Installation 1.5 GPM Flow Rate	Polished Chrome	6	\$135.00
		0125-A	Canopy Handles	Polished Chrome	6	\$132.00
		0128-LE1	Two Handle Cast Brass Kitchen Faucet 2-3/8" Lever Handle 8" Tube Swivel Spout Replaceable Seats 4-Hole 6" Installation Side Spray Assembly 1.5 GPM Flow Rate	Polished Chrome	6	\$150.00
		0126-A	Canopy Handles	Polished Chrome	6	\$147.00
		0127-LE6	Two Handle Cast Brass Kitchen Faucet 2-3/8" Lever Handle 8" D Style Swivel Spout Replaceable Seats 3-Hole 6" Installation 1.5 GPM Flow Rate	Polished Chrome	6	\$152.50
		0127-A	Canopy Handles	Polished Chrome	6	\$149.50
		0128-LE6	Two Handle Cast Brass Kitchen Faucet 2-3/8" Lever Handle 8" D Style Swivel Spout Replaceable Seats 4-Hole 6" Installation Side Spray Assembly 1.5 GPM Flow Rate	Polished Chrome	6	\$167.50
		0128-A	Canopy Handles	Polished Chrome	6	\$164.50
		0148-LE1	Two Handle Shell Type Kitchen Faucet 2-3/8" Lever Handle 8" Tube Swivel Spout Replaceable Seats 3-Hole 8" Installation 1.5 GPM Flow Rate	Polished Chrome	6	\$121.50
		0146-A	Canopy Handles	Polished Chrome	6	\$118.50
		0149-LE1	Two Handle Shell Type Kitchen Faucet 2-3/8" Lever Handle 8" Tube Swivel Spout Replaceable Seats 4-Hole 8" Installation Side Spray Assembly 1.5 GPM Flow Rate	Polished Chrome	6	\$136.50
		0148-LE6	Two Handle Shell Type Kitchen Faucet 2-3/8" Lever Handle 8" D Style Swivel Spout Replaceable Seats 3-Hole 8" Installation 1.5 GPM Flow Rate	Polished Chrome	6	\$142.00
		0149-LE6	Two Handle Shell Type Kitchen Faucet 2-3/8" Lever Handles 8" D Style Swivel Spout Replaceable Seats 4-Hole 8" Installation Side Spray Assembly 1.5 GPM Flow Rate	Polished Chrome	6	\$157.00

Central Brass faucets feature aerators that meet ANSI/ASME A112.18.1 flow requirements of 1.5 GPM



KITCHEN

# KITCHEN // Two Handle Faucets

## TWO HANDLE KITCHEN FAUCETS

Suffix #	Model#	Description	Finish	Case	Price
	2	10-Inch Tube Spout with Aerator (SU-363-JA)	---	---	\$14.00
	3	12-Inch Tube Spout with Aerator (SU-363-LA)	---	---	\$15.00
	4	14-Inch Tube Spout with Aerator (SU-363-MA)	---	---	\$15.50
	8	7-1/4-Inch High-Rise Spout with Aerator (SU-357-HSA)	---	---	\$43.30

## TWO HANDLE KITCHEN FAUCETS



	Model#	Description	Finish	Case	Price
	1172-LE6-Q	Two Handle Concealed Ledge Kitchen Faucet 2-3/8" Lever Handles 8" D Style Swivel Spout Flexible Hose Connections Quarter-Turn Stems Replaceable Seats 3-Hole 6" to 24" Installation 1.5 GPM Flow Rate <b>Note:</b> Mounting Thickness Cannot Exceed 1-3/8"	Polished Chrome	6	\$159.50
	1173-LE6-Q	Two Handle Concealed Ledge Kitchen Faucet 2-3/8" Lever Handles 8" D Style Swivel Spout Flexible Hose Connections Quarter-Turn Stems Replaceable Seats 4-Hole 6" to 24" Installation Side Spray Assembly 1.5 GPM Flow Rate <b>Note:</b> Mounting Thickness Cannot Exceed 1-3/8"	Polished Chrome	6	\$174.50
<b>Suffix #</b>	<b>8</b>	7-1/4-Inch High-Rise Spout with Aerator (SU-357-HSA)		---	\$43.30
	<b>07</b>	8-3/4-Inch High-Rise Swivel Gooseneck Spout with Aerator (SU-357-WSA)		---	\$32.30
	<b>17</b>	4-3/32" Rigid/Swivel Combo Gooseneck Spout With Aerator (CS-22002)		---	\$15.50
	<b>18</b>	5-1/2" Rigid/Swivel Combo Gooseneck Spout With Aerator (CS-22003)		---	\$35.30
	<b>GRA*</b>	4-3/32-Inch Rigid Gooseneck Spout with Aerator (SU-157-GRA)		---	\$15.50
	<b>GSA*</b>	4-3/32-Inch Swivel Gooseneck Spout with Aerator (SU-157-GSA)		---	\$15.50
	<b>KRA*</b>	5-1/2-Inch Rigid Gooseneck Spout with Aerator (SU-157-KRA)		---	\$34.80
	<b>KSA*</b>	5-1/2-Inch Swivel Gooseneck Spout with Aerator (SU-157-KSA)		---	\$35.30
	<b>ELS</b>	4-Inch Wrist Handles (G-4147-C,H) Color-coded Indexes		---	\$25.80
	<b>EL</b>	6-Inch Elbow Handles (G-4149-C,H) Color-coded Indexes		---	\$31.00
	<b>TSA1</b>	6-3/8-Inch Swivel Tri-Arc Gooseneck Spout with Aerator (CS-22001)		---	\$29.00
	<b>L1</b>	Widespread Lever Handles-Indexes (CS-19001C,H)		---	\$59.25
	<b>C1</b>	Widespread Cross Handles-Indexes (CS-19003C,H)		---	\$69.75
	<b>E1.0</b>	1.0 GPM Flow Rate (CS-49011-Male Aerator/CS-49012-Female Aerator)		---	\$4.00
	<b>E0.5</b>	0.5 GPM Flow Rate (CS-49009-Male Aerator/CS-49010-Female Aerator)		---	\$9.50

\*Obsolete once stock is depleted. Replaced with Suffix (17,18)

Central Brass faucets feature aerators that meet ANSI/ASME A112.18.1 flow requirements of 1.5 GPM

# KITCHEN // Two Handle Faucets

## TWO HANDLE KITCHEN FAUCETS







	Model#	Description	Finish	Case	Price
	0072-GSAELS-Q*	Two Handle Concealed Ledge Kitchen Faucet 4" Wrist Blade Handles with Color-Coded Indexes 4-3/32" Gooseneck Swivel Spout 1/2-14 NPS Female Thread Quarter-Turn Stems Replaceable Seats 3-Hole 8" Installation 1.5 GPM Flow Rate <b>Note:</b> Mounting Thickness Cannot Exceed 1/8"	Polished Chrome	6	\$173.25
	1172-GSAEL-Q	Two Handle Concealed Ledge Kitchen Faucet 6" Elbow Handles with Color-Coded Indexes 4-3/32" Gooseneck Swivel Spout Flexible Hose Connections Quarter-Turn Stems Replaceable Seats 3-Hole 6" to 24" Installation 1.5 GPM Flow Rate <b>Note:</b> Mounting Thickness Cannot Exceed 1-3/8"	Polished Chrome	6	\$203.00
	1172-GSAELS-Q	Two Handle Concealed Ledge Kitchen Faucet 4" Wrist Blade Handles with Color-Coded Indexes 4-3/32" Gooseneck Swivel Spout Flexible Hose Connections Quarter-Turn Stems Replaceable Seats 3-Hole 6" to 24" Installation 1.5 GPM Flow Rate <b>Note:</b> Mounting Thickness Cannot Exceed 1-3/8"	Polished Chrome	6	\$197.80

\*Obsolete once stock is depleted

Central Brass faucets feature aerators that meet ANSI/ASME A112.18.1 flow requirements of 1.5 GPM

# KITCHEN // Wallmount/Ledge Faucets









## WALLMOUNT/LEDGE KITCHEN FAUCETS

		Model#	Description	Finish	Case	Price
		0045-LE0	Two Handle Ledge Kitchen Faucet 2-3/8" Lever Handles 6" Tube Swivel Spout 1/2-14 NPS Male Thread Replaceable Seats 2-Hole 8" Installation 1.5 GPM Flow Rate	Polished Chrome	6	\$229.50
		0047-TLE0	Two Handle Wallmount Kitchen Faucet 2-3/8" Lever Handles 6" Tube Swivel Spout 1/2-14 NPT Male Thread Replaceable Seats 2-Hole 7-7/8" to 8-1/8" Installation 1.5 GPM Flow Rate	Polished Chrome	6	\$125.85
		80047-TLE0	Ceramic Disc Cartridges	Polished Chrome	6	\$135.85
		0047-TA	Canopy Handles	Polished Chrome	6	\$122.85
		0047-SLE0	Same as 0047 with 1/2-14 NPS Female Thread 2-Hole 6-1/2 to 9-1/2-Inch Installation 2-3/8" Lever Handles	Polished Chrome	6	\$125.85
		0047-SA	Canopy Handles	Polished Chrome	6	\$122.85
		0047-UA	Same as 0047 with 1/2-14 NPS Female Thread 2-Hole 7-7/8" to 8-1/8" Installation	Polished Chrome	6	\$125.00
		80047-UA	Ceramic Disc Cartridges, Canopy Handles	Polished Chrome	6	\$135.50
				0047-ULE0	Two Handle Wallmount Kitchen Faucet 2-3/8" Lever Handles 6" Tube Swivel Spout 1/2-14 NPS Female Thread Replaceable Seats 2-Hole 7-7/8" to 8-1/8" Installation 1.5 GPM Flow Rate	Polished Chrome
0047-UA3	Canopy Handle			Polished Chrome	6	\$140.00
80047-UA3	Ceramic Disc Cartridges, Canopy Handles			Polished Chrome	6	\$150.50
<b>Suffix #</b>		1	8-Inch Tube Spout with Aerator (SU-363-RA)		---	\$9.00
		2	10-Inch Tube Spout with Aerator (SU-363-JA)		---	\$14.00
		3	12-Inch Tube Spout with Aerators (SU-363-LA)		---	\$15.00
		4	14-Inch Tube Spout with Aerators (SU-363-MA)		---	\$15.50
		6	8-Inch Brass D-Spout with Aerator (SU-365-CA)		---	\$16.00
		9	5-Inch Cast Brass Spout with Aerator (SU-2923-A)		---	\$21.30
		17	4-3/32" Rigid/Swivel Combo Gooseneck Spout With Aerator (CS-22002)		---	\$15.50
		18	5-1/2" Rigid/Swivel Combo Gooseneck Spout With Aerator (CS-22003)		---	\$35.30
		GRA*	4-3/32-Inch Rigid Gooseneck Spout with Aerator (SU-157-GRA)		---	\$15.50
		GSA*	4-3/32-Inch Swivel Gooseneck Spout with Aerator (SU-157-GSA)		---	\$15.50
		KRA*	5-1/2-Inch Rigid Gooseneck Spout with Aerator (SU-157-KRA)		---	\$34.80
		KSA*	5-1/2-Inch Swivel Gooseneck Spout with Aerator (SU-157-KSA)		---	\$35.30
		H	Hose Adapter (PF-784-C)		---	\$1.30
		ELS	4-Inch Wrist Handles (G-4147-C,H) Color-coded Indexes		---	\$25.80
		EL	6-Inch Elbow Handles (G-4149-C,H) Color-coded Indexes		---	\$31.00
		Q	Quarter-Turn Stems (G-454-EL,ER)		---	\$1.80
		E1.0	1.0 GPM Flow Rate (CS-49011-Male Aerator/CS-49012-Female Aerator)		---	\$4.00
		E0.5	0.5 GPM Flow Rate (CS-49009-Male Aerator/CS-49010-Female Aerator)		---	\$9.50

\*Obsolete once stock is depleted.  
Replaced with Suffix (17,18)

# KITCHEN // Wallmount/Ledge Faucets









## WALLMOUNT/LEDGE KITCHEN FAUCETS

	Model#	Description	Finish	Case	Price
	 	<b>0046-LE0</b> Two Handle Wallmount Kitchen Faucet 2-3/8" Lever Handles 6" Tube Swivel Spout 1/2-14 NPS Male Thread Replaceable Seats 2-Hole 8" Installation Brass Soap Dish 1.5 GPM Flow Rate	Polished Chrome	6	\$238.00
		 	<b>0048-TLE0</b> Two Handle Wallmount Kitchen Faucet 2-3/8" Lever Handles 6" Tube Swivel Spout 1/2-14 NPT Male Thread Replaceable Seats 2-Hole 7-7/8" to 8-1/8" Installation Brass Soap Dish 1.5 GPM Flow Rate	Polished Chrome	6
<b>0048-TA</b>		Canopy Handles	Polished Chrome	6	\$130.00
<b>80048-TA</b>		Ceramic Disc Cartridges, Canopy Handles	Polished Chrome	6	\$140.50
<b>0048-SLE0</b>		Same as 0048 with 1/2-14 NPS Female Thread 2-Hole 6-1/2 to 9-1/2 Installation 2-3/8" Lever Handles	Polished Chrome	6	\$145.00
<b>0048-SA</b>		Canopy Handles	Polished Chrome	6	\$142.00
<b>0048-UA</b>		Same as 0048 with 1/2-14 NPS Female Thread 2-Hole 7 7/8" to 8 1/8" Installation	Polished Chrome	6	\$140.00
<b>80048-UA</b>		Ceramic Disc Cartridges, Canopy Handles	Polished Chrome	6	\$150.50
	 	<b>0048-ULE0</b> Two Handle Wallmount Kitchen Faucet 2-3/8" Lever Handles 6" Tube Swivel Spout 1/2-14 NPS Female Thread Replaceable Seats 2-Hole 7-7/8" to 8-1/8" Installation Brass Soap Dish 1.5 GPM Flow Rate	Polished Chrome	6	\$143.00
	<b>0048-UA3</b>	Canopy Handles	Polished Chrome	6	\$155.00
<b>Suffix #</b>	<b>1</b>	8-Inch Tube Spout with Aerator (SU-363-RA)		---	\$9.00
	<b>2</b>	10-Inch Tube Spout with Aerator (SU-363-JA)		---	\$14.00
	<b>3</b>	12-Inch Tube Spout with Aerator (SU-363-LA)		---	\$15.00
	<b>4</b>	14-Inch Tube Spout with Aerator (SU-363-MA)		---	\$15.50
	<b>6</b>	8-Inch Brass D-Spout with Aerator (SU-365-CA)		---	\$16.00
	<b>9</b>	5-Inch Cast Brass Spout with Aerator (SU-2923-A)		---	\$21.30
	<b>H</b>	Hose Adapter (PF-784-C)		---	\$1.30
	<b>ELS</b>	4-Inch Wrist Handles (G-4147-C,H) Color-coded Indexes		---	\$25.80
	<b>EL</b>	6-Inch Elbow Handles (G-4149-C,H) Color-coded Indexes		---	\$31.00
	<b>Q</b>	Quarter-Turn Stems (G-454-EL,ER)		---	\$1.80
	<b>E1.0</b>	1.0 GPM Flow Rate (CS-49011-Male Aerator/CS-49012-Female Aerator)		---	\$4.00
	<b>E0.5</b>	0.5 GPM Flow Rate (CS-49009-Male Aerator/CS-49010-Female Aerator)		---	\$9.50

Central Brass faucets feature aerators that meet ANSI/ASME A112.18.1 flow requirements of 1.5 GPM

# SERVICE SINK // Faucets



## SERVICE SINK FAUCETS

	Model#	Description	Finish	Case	Price
	 0050-ULERC	Two Handle Wallmount Service Sink Faucet 2-3/8" Lever Handles 2-1/2" Rigid Spout With Pail Hook, Hose Thread 1/2-14 NPS Female Thread Replaceable Seats 2-Hole 7-7/8" to 8-1/8" Installation Vacuum Breaker	Rough Chrome	6	\$156.50
	0050-URC	Canopy Handles	Rough Chrome	6	\$153.50
	 0050-URC-QI	Two Handle Wallmount Service Sink Faucet Canopy Handles With Color Coded Indexes 2-1/2" Rigid Spout With Pail Hook, Hose Thread 1/2-14 NPS Female Thread Quarter-Turn Stems Replaceable Seats, Built-in Stops 2-Hole 7-7/8" to 8-1/8" Installation Vacuum Breaker	Rough Chrome	6	\$176.00
	80050-U-I	Ceramic Disc Cartridges	Polished Chrome	6	\$233.10
	 0051-URC	Two Handle Wallmount Service Sink Faucet Canopy Handles 2-1/2" Rigid Spout With Pail Hook, Hose Thread 1/2-14 NPS Female Thread Replaceable Seats 2-Hole 7-7/8" to 8-1/8" Installation	Rough Chrome	6	\$126.50
	 0054-ULE-Q	Two Handle Wallmount Service Sink Faucet 2-3/8" Lever Handles 5-3/4" Rigid Spout With Pail Hook And Top Brace to Wall With Flange, Hose Thread 1/2-14 NPS Female Thread Quarter-Turn Stems Replaceable Seats, Built-in Stops 2-Hole 7-7/8" to 8-1/8" Installation Vacuum Breaker	Polished Chrome	6	\$193.00
	0054-ULE-QI	Built in Stops	Polished Chrome	6	\$238.00
	0054-U-QI	Canopy Handles	Polished Chrome	6	\$235.00
	0054-URC-QI	Canopy Handles	Rough Chrome	6	\$182.00
	80054-U-I	Ceramic Disc Cartridges	Polished Chrome	6	\$245.50
	0054-U-Q	Two Handle Wallmount Service Sink Faucet Canopy Handles	Polished Chrome	6	\$190.00
0054-URC-Q	Two Handle Wallmount Service Sink Faucet 5-3/4" Rigid Spout With Pail Hook And Top Brace to Wall With Flange, Hose Thread 1/2-14 NPS Female Thread Quarter-Turn Stems Replaceable Seats 2-Hole 7-7/8" to 8-1/8" Installation Vacuum Breaker	Rough Chrome	6	\$169.00	
<b>Suffix #</b>	<b>ELS</b>	4-Inch Wrist Handles (G-4147-C,H) Color-coded Indexes	---	---	\$25.80
	<b>EL</b>	6-Inch Elbow Handles (G-4149-C,H) Color-coded Indexes	---	---	\$31.00
	<b>S</b>	1/2-14 NPS Female Inlet Flanges (SU-2806) (Adjustable 6-1/2 to 9-1/2-Inch Centers)	---	---	\$15.50
	<b>T</b>	1/2-14 NPT Male Inlet Shank Flanges (SU-2846) (Adjustable 7-7/8 to 8-1/8-Inch Centers)	---	---	\$10.50
	<b>YRC</b>	1/2-14 NPS Female Inlet Flanges with Integral Stops (SU-2841-ARC) (Adjustable 3 to 13-Inch Centers)	---	---	\$46.00

Central Brass faucets feature aerators that meet ANSI/ASME A112.18.1 flow requirements of 1.5 GPM

# SERVICE SINKS // Faucets

## SERVICE SINK FAUCETS

	Model#	Description	Finish	Case	Price
	CS-65002	Hose Bracket Stainless Steel Construction Spring Loaded Grip 30" Heavy Duty Rubber Hose With 3/4" Hose Thread Connection Mounting Hardware Included	Polished Chrome	6	\$44.60
	CS-65001	Stainless Steel Mop Hanger Stainless Steel Construction Spring Loaded Grips Mounting Hardware Included	Stainless Steel	6	\$60.50
Easy Install Adapter for Models: 0047, 0048, 0050, 0051, 0054.	CS-42002	Easy Install Adapter for Chicago Faucet to Central Brass		---	\$35.20
	CS-42003	Easy Install Adapter for T & S Faucet to Central Brass		---	\$31.80
	CS-42004	Easy Install Adapter for Fisher Faucet to Central Brass		---	\$39.80

Central Brass faucets feature aerators that meet ANSI/ASME A112.18.1 flow requirements of 1.5 GPM

# BAR // Glass Fillers

## GLASS FILLERS

	Model#	Description	Finish	Case	Price
	✓ 0393	Glass Filler Push Button Type 2-1/2" Gooseneck Rigid Spout 3/8-18 NPS Female Thread 1-Hole Installation	Polished Chrome	6	\$82.00
<b>Suffix #</b>	<b>MG</b>	With 3/8" x 1/2" Shank (781-A) and Mounting Group (G-95-A)		---	\$15.00

Central Brass faucets feature aerators that meet ANSI/ASME A112.18.1 flow requirements of 1.5 GPM

# BAR // Single Handle Faucets

## SINGLE BAR HANDLE FAUCETS





		Model#	Description	Finish	Case	Price
		0280-AC	Single Handle Bar Faucet Canopy Handle	Polished Chrome	6	\$107.00
		0280-AH	5" Cast Brass Spout 1/2-14 NPS Male inlet x 1-7/8" Long Replaceable Seat 1-Hole Installation 1.5 GPM Flow Rate	Polished Chrome	6	\$107.00
		0280-GSAC	Single Handle Bar Faucet Canopy Handle 4-3/32" Gooseneck Swivel Spout 1/2-14 NPS Male inlet x 1-7/8" Long Replaceable Seat 1-Hole Installation Cold Only 1.5 GPM Flow Rate	Polished Chrome	6	\$116.50
		0281-AC	Single Handle Bar Faucet Canopy Handle	Polished Chrome	6	\$92.50
		0281-AH	4-5/16" Gooseneck Rigid Spout 1/2-14 NPS Male inlet x 1-7/8" Long Replaceable Seat 1-Hole Installation 1.5 GPM Flow Rate	Polished Chrome	6	\$92.50
		0282	Single Handle Dishwasher Faucet Canopy Handle 2-13/16" Rigid Spout 1/2-14 NPS Male inlet x 1-7/8" Long Replaceable Seat 1-Hole Installation 1.5 GPM Flow Rate	Polished Chrome	6	\$82.80

Central Brass faucets feature aerators that meet ANSI/ASME A112.18.1 flow requirements of 1.5 GPM

BAR

# BAR // Two Handle Faucets



## TWO HANDLE BAR FAUCETS

	Model#	Description	Finish	Case	Price
	0284-A-Q	Two Handle Bar/Pantry Faucet Tear Drop Handles 5-1/8" Gooseneck Rigid Spout 1-1/16-14 NPS Male Thread Quarter-Turn Stems Replaceable Seats 1-Hole Installation Copper Supply Tubes 1.5 GPM Flow Rate	Polished Chrome	6	\$164.00
	0285-A-Q	Two Handle Bar/Pantry Faucet Tear Drop Handles 5-9/16" Gooseneck Swivel Spout 1-1/16-14 NPS Male Thread Quarter-Turn Stems Replaceable Seats 1-Hole Installation Copper Supply Tubes 1.5 GPM Flow Rate	Polished Chrome	6	\$178.00
	0286-AC	Single Handle Bar Faucet Canopy Handle	Polished Chrome	6	\$80.50
	0286-AH	4-11/16" Gooseneck Rigid Spout	Polished Chrome	6	\$80.50
	80286-AC	1/2-14 NPS Male inlet x 1-7/8" Long Replaceable Seat 1-Hole Installation 1.5 GPM Flow Rate	Polished Chrome	6	\$85.50
	0287-LE17	Two Handle Bar/Pantry Faucet Canopy Handles	Polished Chrome	6	\$147.00
	0287-LE18*	4-3/32" Gooseneck Rigid/Swivel Spout 1-1/16-14 NPS Male Thread Replaceable Seats 1-Hole Installation Copper Supply Tubes 1.5 GPM Flow Rate *5-1/2" Rigid/Swivel Spout	Polished Chrome	6	\$148.80

Central Brass faucets feature aerators that meet ANSI/ASME A112.18.1 flow requirements of 1.5 GPM

# BAR // Two Handle Faucets









## TWO HANDLE BAR FAUCETS

	Model#	Description	Finish	Case	Price
	0287-GSAELS-Q	Two Handle Bar/Pantry Faucet 4" Wrist Blade Handles with Color-Coded Indexes 4-3/32" Gooseneck Swivel Spout 1-1/16-14 NPS Male Thread Quarter-Turn Stems Replaceable Seats 1-Hole Installation Copper Supply Tubes 1.5 GPM Flow Rate	Polished Chrome	6	\$174.60
	0289-A	Two Handle Bar Faucet Canopy Handles 3-15/16" Gooseneck Rigid Spout 1-1/16-14 NPS Male Thread Replaceable Seats 1-Hole Installationz Copper Supply Tubes 1.5 GPM Flow Rate	Polished Chrome	6	\$135.00

Central Brass faucets feature aerators that meet ANSI/ASME A112.18.1 flow requirements of 1.5 GPM

# BAR & LAUNDRY // Faucets







## TWO HANDLE BAR & LAUNDRY FAUCETS

		Model#	Description	Finish	Case	Price
		0084-LE0	Two Handle Cast Brass Bar/Laundry Faucet 2-3/8" Lever Handles 6" Tube Swivel Spout Replaceable Seats 2 or 3-Hole 4" Installation 1.5 GPM Flow Rate	Polished Chrome	6	\$99.00
		0084-A	Canopy Handles	Polished Chrome	6	\$96.00
		80084-A	Ceramic Disc Cartridges, Canopy Handles	Polished Chrome	6	\$106.50
		80084-AELS	Two Handle Cast Brass Bar/Laundry Faucet 4" Wrist Blade Handles with Color-Coded Indexes 6" Tube Swivel Spout Ceramic Disc Cartridges 2 or 3-Hole 4" Installation 1.5 GPM Flow Rate	Polished Chrome	6	\$132.30
		0094-GSAELS	Two Handle Shell Type Bar/Laundry Faucet 4" Wrist Blade Handles with Color-Coded Indexes 4-3/32" Gooseneck Swivel Spout Replaceable Seats 2 or 3-Hole 4" Installation 1.5 GPM Flow Rate	Polished Chrome	6	\$126.30
		0094-LE0	Two Handle Shell Type Bar/Laundry Faucet 2-3/8" Lever Handles 6" Tube Swivel Spout Replaceable Seats 2 or 3-Hole 4" Installation 1.5 GPM Flow Rate	Polished Chrome	6	\$88.00
		0094-A	Canopy Handles	Polished Chrome	6	\$85.00
<b>Suffix #</b>		1	8-Inch Tube Spout with Aerator (SU-363-RA)		---	\$9.00
		2	10-Inch Tube Spout with Aerator (SU-363-JA)		---	\$14.00
		3	12-Inch Tube Spout with Aerator (SU-363-LA)		---	\$15.00
		4	14-Inch Tube Spout with Aerator (SU-363-MA)		---	\$15.50
		6	8-Inch Brass D-Spout with Aerator (SU-365-CA)		---	\$16.00
		8	7-1/4-Inch High-rise Spout with Aerator (SU-357-HSA)		---	\$43.30
		17	4-3/32" Rigid/Swivel Combo Gooseneck Spout With Aerator (CS-22002)		---	\$15.50
		18	5-1/2" Rigid/Swivel Combo Gooseneck Spout With Aerator (CS-22003)		---	\$35.30
		GRA*	4-3/32-Inch Rigid Gooseneck Spout with Aerator (SU-157-GRA)		---	\$15.50
		GSA*	4-3/32-Inch Swivel Gooseneck Spout with Aerator (SU-157-GSA)		---	\$15.50
		KRA*	5-1/2-Inch Rigid Gooseneck Spout with Aerator (SU-157-KRA)		---	\$34.80
		KSA*	5-1/2-Inch Swivel Gooseneck Spout with Aerator (SU-157-KSA)		---	\$35.30
		H	Hose Adapter (PF-784-C)		---	\$1.30
		ELS	4-Inch Wrist Handles (G-4147-C,H) Color-coded Indexes		---	\$25.80
		EL	6-Inch Elbow Handles (G-4149-C,H) Color-coded Indexes		---	\$31.00
		Q	Quarter-Turn Stems (G-454-EL,ER)		---	\$1.80

\*Obsolete once stock is depleted. Replaced with Suffix (17,18) Central Brass faucets feature aerators that meet ANSI/ASME A112.18.1 flow requirements of 1.5 GPM

# BAR & LAUNDRY // Faucets













## TWO HANDLE BAR & LAUNDRY FAUCETS

		Model#	Description	Finish	Case	Price
		0084-LE17	Two Handle Cast Brass Bar/Laundry Faucet 2-3/8" Lever Handles 4-3/32" Gooseneck Rigid/Swivel Spout Replaceable Seats 2 or 3-Hole 4" Installation 1.5 GPM Flow Rate	Polished Chrome	6	\$114.50
		0084-GSA	Canopy Handles	Polished Chrome	6	\$111.50
		80084-GSA	Ceramic Disc Cartridges, Canopy Handles	Polished Chrome	6	\$122.00
		0084-GSAEL	Two Handle Cast Brass Bar/Laundry Faucet 6" Elbow Handles with Color-Coded Indexes 4-3/32" Gooseneck Swivel Spout Replaceable Seats 2 or 3-Hole 4" Installation 1.5 GPM Flow Rate	Polished Chrome	6	\$142.50
		0084-GSAELS	Two Handle Cast Brass Bar/Laundry Faucet 4" Wrist Blade Handles with Color-Coded Indexes 4-3/32" Gooseneck Swivel Spout Replaceable Seats 2 or 3-Hole 4" Installation 1.5 GPM Flow Rate	Polished Chrome	6	\$137.30
		80084-GSAELS	Ceramic Disc Cartridge	Polished Chrome	6	\$147.80

Central Brass faucets feature aerators that meet ANSI/ASME A112.18.1 flow requirements of 1.5 GPM

# LAUNDRY // Faucets



## TWO HANDLE LAUNDRY FAUCETS

	Model#	Description	Finish	Case	Price
	 0465-LE	Two Handle Laundry Faucet 2-3/8" Lever Handles	Rough Brass	6	\$77.75
	0465*	6" Tube Swivel Spout, Hose Thread 1/2" IP or copper Sweat Union Inlets	Rough Brass	6	\$74.75
	80465**	3-1/2" Centers / Replaceable Seats Straddle Legs * Lever Handles **Ceramic Disc Cartridges	Rough Brass	6	\$85.25
	 0466	Two Handle Laundry Faucet Lever Handles	Rough Brass	6	\$64.00
	80466*	6" Tube Swivel Spout, Hose Thread Direct Sweat Inlets 3-1/2" Centers / Replaceable Seats Straddle Legs *Ceramic Disc Cartridges	Rough Brass	6	\$74.50
	 0468	Two Handle Laundry Faucet Lever Handles 6" Tube Swivel Spout, Hose Thread 1/2" IP or copper Sweat Union Inlets 3-1/2" Centers Extended Straddle Legs	Rough Brass	6	\$95.50
	 0469	Two Handle Laundry Faucet Lever Handles 6" Tube Swivel Spout, Hose Thread 1/2" IP or copper Sweat Union Inlets 3-1/2" Centers Extended Hole Mount Legs	Rough Brass	6	\$102.50
	 0470	Two Handle Laundry Faucet Lever Handles 6" Tube Swivel Spout, Hose Thread 1/2" IP or copper Sweat Union Inlets 3-1/2" Centers Offset Legs For Wallmount	Rough Brass	6	\$96.50
<b>Suffix #</b>	<b>5</b>	6-Inch Cast Spout with Hose End (SU-2929-01) Rough Brass		---	\$9.00
	0471-RC	Two Handle Laundry Faucet 4-Arm Handle 4-1/2" Swivel Spout, Hose Thread 1/2" IP or copper Sweat Union Inlets Replaceable Seats 6" Centers	Rough Chrome	6	\$150.50
	0455	Wash Machine Filler Canopy Handles 1/2" IP or copper Sweat Union Inlets Replaceable Seats 8" Centers	Polished Chrome	8	\$116.50

Central Brass faucets feature aerators that meet ANSI/ASME A112.18.1 flow requirements of 1.5 GPM

# WORKBOARD SINK // Faucets













WORKBOARD SINK FAUCETS

	Model#	Description	Finish	Case	Price
	0184-LE0	Two Handle Cast Brass Wallmount Faucet 2-3/8" Lever Handle 6" Tube Swivel Spout Replaceable Seats 2-Hole 4" Installation 1.5 GPM Flow Rate	Polished Chrome	6	\$103.00
	0194-LE0	Two Handle Shell Type Wallmount Faucet 2-3/8" Lever Handle 6" Tube Swivel Spout Replaceable Seats 2-Hole 4" Installation 1.5 GPM Flow Rate	Polished Chrome	6	\$92.00
<b>Suffix #</b>					
	1	8" Tube Swivel Spout with Aerator (SU-363-RA)		---	\$9.00
	2	10" Tube Swivel Spout with Aerator (SU-363-JA)		---	\$14.00
	3	12" Tube Swivel Spout with Aerator (SU-363-LA)		---	\$15.00
	4	14" Tube Swivel Spout with Aerator (SU-363-MA)		---	\$15.50
	6	8" Brass Swivel D-Spout with Aerator (SU-365-CA)		---	\$16.00
	07	8-3/4" High-Rise Swivel Gooseneck Spout with Aerator (SU-357-WSA)		---	\$32.30
	8	7-1/4" High-Rise Spout with Aerator (SU-357-HSA)		---	\$43.30
	9	5" Cast Brass Spout With Aerator (SU-2923-A)		---	\$21.30
	13	16" Tube Swivel Spout With Aerator (CS-22004)		---	\$16.00
	17	4-3/32" Rigid/Swivel Combo Gooseneck Spout With Aerator (CS-22002)		---	\$15.50
	18	5-1/2" Rigid/Swivel Combo Gooseneck Spout With Aerator (CS-22003)		---	\$35.30
	23	18" Tube Swivel Spout With Aerator (CS-22005)		---	\$16.50
	EX	7" Cast Brass Spout Extension (SU-2775-R-02)		---	\$15.00

Central Brass faucets feature aerators that meet ANSI/ASME A112.18.1 flow requirements of 1.5 GPM

# LAVATORY // Two Handle Faucets











## TWO HANDLE LAVATORY FAUCETS

	Model#	Description	Finish	Case	Price
	  	<b>1137-LE</b> Two Handle Lavatory Faucet 2-3/8" Lever Handles Replaceable Seats 3-Hole 4" Installation With Hole Cover 1.2 GPM Flow Rate	Polished Chrome	6	\$115.00
		<b>1137-DLE</b> Brass Pop-Up Drain Assembly	Polished Chrome	6	\$147.00
		<b>1137-A</b> Canopy Handles	Polished Chrome	6	\$112.00
		<b>81137-A</b> Ceramic Disc Cartridges, Canopy Handles	Polished Chrome	6	\$122.50
		<b>1137-DA</b> Two Handle Lavatory Faucet Canopy Handles Replaceable Seats 3-Hole 4" Installation Brass Pop-Up Drain Assembly 1.2 GPM Flow Rate	Polished Chrome	6	\$144.00
		<b>81137-DA</b> Ceramic Disc Cartridges, Canopy Handles	Polished Chrome	6	\$154.50
		<b>1137-DAEL</b> Two Handle Lavatory Faucet 6" Elbow Handles with Color-Coded Indexes Replaceable Seats 3-Hole 4" Installation Brass Pop-Up Drain Assembly 1.2 GPM Flow Rate	Polished Chrome	6	\$175.00
	  	<b>1137-AELS</b> Two Handle Lavatory Faucet 4" Wrist Blade Handles with Color-Coded Indexes Replaceable Seats 3-Hole 4" Installation 1.2 GPM Flow Rate	Polished Chrome	6	\$132.00
		<b>81137-AELS</b> Ceramic Disc Cartridges	Polished Chrome	6	\$142.50
		<b>1137-DAELS</b> Two Handle Lavatory Faucet 4" Wrist Blade Handles with Color-Coded Indexes Replaceable Seats 3-Hole 4" Installation Brass Pop-Up Drain Assembly 1.2 GPM Flow Rate	Polished Chrome	6	\$164.00
		<b>81137-DAELS</b> Ceramic Disc Cartridges	Polished Chrome	6	\$174.50
<b>Suffix #</b>	<b>Q</b>	Quarter-Turn Stems (G-454-EL,ER)		- - -	\$1.80
	  	<b>1138-LE</b> Two Handle Lavatory Faucet 2-3/8" Lever Handles Chain & Stopper Replaceable Seats 3-Hole 4" Installation No Lift Rod Hole 1.2 GPM Flow Rate	Polished Chrome	6	\$122.00
		<b>1138-A</b> Canopy Handles	Polished Chrome	6	\$119.00

Central Brass faucets feature aerators that meet ANSI/ASME A112.18.1 flow requirements of 1.5 GPM

# LAVATORY // Two Handle Faucets









## TWO HANDLE LAVATORY FAUCETS

		Model#	Description	Finish	Case	Price
		1133-LE	Two Handle Lavatory Faucet 2-3/8" Lever Handles 4-5/8" Extended Spout Replaceable Seats 3-Hole 4" Installation 1.2 GPM Flow Rate	Polished Chrome	6	\$116.50
		1133-DLE	Brass Pop-Up Drain Assembly	Polished Chrome	6	\$148.00
		1133-A	Canopy Handles	Polished Chrome	6	\$113.50
		1167-AV	Self-Close Two Handle Lavatory Faucet Vandal-Resistant Lever Handles Replaceable Seats 3-Hole 4" Installation 1.2 GPM Flow Rate	Polished Chrome	6	\$249.10
		3137-AN2	Slow-Close Two Handle Lavatory Faucet Push Handles	Polished Chrome	6	\$206.00
		3137-AVN2*	3-Hole 4" Installation 1.2 GPM Flow Rate *Vandal Resistant 0.5 GPM Flow Rate <b>Note:</b> New ADA Compliant Cartridge and Handle Kit (CS-49016C,H,P) Fits Old/New Slow Close Faucets.	Polished Chrome	6	\$209.00
		3137-DAN2	Slow-Close Two Handle Lavatory Faucet Push Handles 3-Hole 4" Installation Brass Pop-Up Drain Assembly 1.2 GPM Flow Rate *Vandal Resistant 0.5 GPM Flow Rate <b>Note:</b> New ADA Compliant Cartridge and Handle Kit (CS-49016C,H,P) Fits Old/New Slow Close Faucets.	Polished Chrome	6	\$238.00
		1177-LE	Two Handle Shelf Back Lavatory Faucet	Polished Chrome	6	\$137.30
		1177-DLE	2-3/8" Lever Handle Replaceable Seats	Polished Chrome	6	\$169.30
		1177-A*	3-Hole 4" to 6" Installation 1.2 GPM Flow Rate	Polished Chrome	6	\$134.30
		1177-DA*	Brass Pop-Up Drain Assembly *Canopy Handles	Polished Chrome	6	\$166.30
		1178-LE	Two Handle Slant Back Lavatory Faucet	Polished Chrome	6	\$171.50
		1178-DLE	2-3/8" Lever Handle 45-Degree Slant Back Spout	Polished Chrome	6	\$202.50
		1178-A*	Replaceable Seats 3-Hole 4" to 6" Installation 1.2 GPM Flow Rate	Polished Chrome	6	\$167.50
		1178-DA*	Brass Pop-Up Drain Assembly *Canopy Handles	Polished Chrome	6	\$199.50

Central Brass faucets feature aerators that meet ANSI/ASME A112.18.1 flow requirements of 1.5 GPM

# LAVATORY // Two Handle Faucets



## TWO HANDLE LAVATORY FAUCETS

	Model#	Description	Finish	Case	Price
	  <b>1125-A</b>	Two Handle Widespread Lavatory Faucet Round Metal Handles 4-1/2" Low Profile Spout	Polished Chrome	6	\$149.00
	<b>81125-A*</b>	Flexible Hose Connections Replaceable Seats 3-Hole 6" to 24" Installation With Hole Cover 1.2 GPM Flow Rate *Ceramic Disc Cartridges	Polished Chrome	6	\$159.50
	<b>1125-DA</b>	Two Handle Widespread Lavatory Faucet Round Metal Handles 4-1/2" Low Profile Spout	Polished Chrome	6	\$179.00
	<b>81125-DA*</b>	Flexible Hose Connections Replaceable Seats 3-Hole 6" to 24" Installation Brass Pop-Up Drain Assembly 1.2 GPM Flow Rate *Ceramic Disc Cartridges	Polished Chrome	6	\$189.50
	  <b>1172-11AELS-Q</b>	Two Handle Widespread Lavatory Faucet 4" Wrist Blade Handles with Color-Coded Indexes 4-1/2" Low Profile Spout Flexible Hose Connections Quarter-Turn Stems Replaceable Seats 3-Hole 6" to 24" Installation 1.2 GPM Flow Rate	Polished Chrome	6	\$198.00
	  <b>81172-D12AL1</b> <b>81172-D12AL1-BN</b>	Two Handle Widespread Lavatory Faucet Lever Handles 5-7/16" 'C' Style Spout Flexible Hose Connections Ceramic Disc Cartridges 3-Hole 6" to 24" Installation Brass Pop-Up Drain Assembly 1.2 GPM Flow Rate	Polished Chrome PVD Brushed Nickel	6 6	\$292.50 \$350.50

Central Brass faucets feature aerators that meet ANSI/ASME A112.18.1 flow requirements of 1.5 GPM

# LAVATORY // Two Handle Faucets





## TWO HANDLE LAVATORY FAUCETS

	Model#	Description	Finish	Case	Price
	  3127-AN1	Slow-Close Two Handle Widespread Lavatory Faucet Push Handles	Polished Chrome	6	\$270.00
	3127-AVN1*	4-1/2" Low Profile Spout Flexible Hose Connections 3-Hole 6" to 24" Installation No Lift Rod Hole 1.2 GPM Flow Rate *Vandal Resistant 0.5 GPM Flow Rate <b>Note:</b> New ADA Compliant Cartridge and Handle Kit (CS-49017C,H,P) Fits Old/New Slow Close Faucets.	Polished Chrome	6	\$273.00

Central Brass faucets feature aerators that meet ANSI/ASME A112.18.1 flow requirements of 1.5 GPM

# LAVATORY // Single Basin Faucets





## SINGLE BASIN LAVATORY FAUCETS

	Model#	Description	Finish	Case	Price
	✓ 0239-P	Single Handle Basin Faucet 4-Arm Handle With Optional Red/Blue Indexes Plain End	Polished Chrome	6	\$49.50
	0239-AP*	1/2-14 NPS Male Inlet x 2-1/4" Long Replaceable Seat 1-Hole Installation *1.2 GPM Flow Rate	Polished Chrome	6	\$53.50
	✓ 0255-C	Self-Close Single Handle Basin Faucet 4-Arm Handle Plain End	Polished Chrome	6	\$73.40
	0255-P	1/2-14 NPS Male Inlet x 2-1/4" Long	Polished Chrome	6	\$73.40
	0255-H	Replaceable Seat	Polished Chrome	6	\$73.40
	0255-AC*	1-Hole Installation	Polished Chrome	6	\$80.50
	0255-AP*	*1.2 GPM Flow Rate	Polished Chrome	6	\$80.50
	0255-AH*		Polished Chrome	6	\$80.50
<b>Suffix #</b>		<b>V</b>	Vandal-Resistant Cap (0255 and 0255-A Only)	---	\$3.30
	✓ 0355-AN2C	Slow-Close Single Handle Basin Faucet Push Handle	Polished Chrome	6	\$114.50
	0355-AN2P	1/2-14 NPS Male Inlet x 2-1/4" Long	Polished Chrome	6	\$114.50
	0355-AN2H	1-Hole Installation	Polished Chrome	6	\$114.50
	0355-AVN2C*	1.2 GPM Flow Rate	Polished Chrome	6	\$117.50
	0355-AVN2P*	*Vandal Resistant 0.5 GPM Flow Rate <b>Note:</b> New ADA Compliant Cartridge and Handle Kit (CS-49016C,H,P) Fits Old/New Slow Close Faucets.	Polished Chrome	6	\$117.50
	✓ 0356-AN2C	Deluxe Slow-Close Single Handle Basin Faucet Push Handle	Polished Chrome	6	\$136.00
	0356-AN2P	1/2-14 NPS Male Inlet x 2-1/4" Long 1-Hole Installation 1.2 GPM Flow Rate *Vandal Resistant 0.5 GPM Flow Rate <b>Note:</b> New ADA Compliant Cartridge and Handle Kit (CS-49016C,H,P) Fits Old/New Slow Close Faucets.	Polished Chrome	6	\$136.00

Central Brass faucets feature aerators that meet ANSI/ASME A112.18.1 flow requirements of 1.5 GPM

# TUB & SHOWER // Sets

## TUB & SHOWER SETS





	Model#	Description	Finish	Case	Price
	80805	Two Handle Vavle Set Canopy Handles Ceramic Disc Cartridges 1/2" CXC Inlets 8" Centers Built-in Transfer Valve, Brass Plug Included	Polished Chrome	8	\$101.25
	8088-Z	Two Handle Tub Set Canopy Handles Replaceable Seats 1/2" CXC Inlets 8" Centers 1/2" IPS & Slip-on Combo Tub Spout Built-in Transfer Valve, Brass Plug Included	Polished Chrome	8	\$108.40
	80826	Two Handle Shower Set Canopy Handles Replaceable Seats Shower Head, Arm & Flange 1/2" CXC Inlets 8" Centers Built-in Transfer Valve, Brass Plug Included	Polished Chrome	8	\$117.75
	80826	Same as 80826 with Ceramic Disc Cartridges	Polished Chrome	8	\$132.25
	80897 (Canopy Option Left)	Two Handle Tub & Shower Set Canopy Handles Replaceable Seats Shower Head, Arm & Flange 1/2" CXC Inlets 8" Centers 1/2" IPS & Slip-on Combo Diverter Tub Spout Built-in Transfer Valve	Polished Chrome	8	\$143.50
	80897	Same as 80897 with Ceramic Disc Cartridges	Polished Chrome	8	\$158.00
	80897-L3	Same as 80897 with Lever Handles	Polished Chrome	8	\$222.00
	80897-C3	Same as 80897 with Cross Handles	Polished Chrome	8	\$234.00

Tub & shower sets available in Brushed Nickel.  
Call for pricing and availability.

Central Brass showerheads meet ANSI/ASME A112.18.1 flow requirements of maximum 2.5 GPM

# TUB & SHOWER // Sets

## TUB & SHOWER SETS



	Model#	Description	Finish	Case	Price
	0850	Three Handle Valve Set Canopy Handles Replaceable Seats 1/2" CXC Inlets 8" Centers	Polished Chrome	8	\$108.75
	80850	Same as 0850 with Ceramic Disc Cartridges	Polished Chrome	8	\$123.25
	0868	Three Handle Tub & Shower Set Canopy Handles Shower Head, Arm & Flange 1/2" CXC Inlets Replaceable Seats 8" Centers 1/2" IPS Brass Tub Spout	Polished Chrome	8	\$190.76
	0868-Z	With 1/2" IPS & Slip-on Combo Tub Spout	Polished Chrome	8	\$160.25
	80868	Same as 0868 with Ceramic Disc Cartridges	Polished Chrome	8	\$205.30
	80868-Z	Same as 80868 W/ 1/2" IPS & Slip-on Combo Tub Spout	Polished Chrome	8	\$174.75
	 80868-L3 (Lever Option Left)	Same as 80868 with Lever Handles	Polished Chrome	8	\$296.00
80868-C3	Same as 80868 with Cross Handles	Polished Chrome	8	\$314.50	
	0905	Two Handle Valve Set Canopy Handles 1/2" IP or copper Sweat Union Inlets Replaceable Seats 8" Centers Built-in Transfer Valve, Brass Plug Included	Polished Chrome	8	\$95.25
	80905	Same as 0905 with Ceramic Disc Cartridges	Polished Chrome	8	\$109.75
	0908-Z	Two Handle Tub Set Canopy Handles 1/2" IP or copper Sweat Union Inlets Replaceable Seats 8" Centers 1/2" IPS & Slip-on Combo Tub Spout Built-in Transfer Valve, Brass Plug Included	Polished Chrome	8	\$116.35
	0908	Same as 0908-Z with Cast Brass Tub Spout	Polished Chrome	8	\$146.35

Tub & shower sets available in Brushed Nickel.  
Call for pricing and availability.

All L3 Lever Handles for Central Brass Tub & Showers are ADA Compliant  
Central Brass showerheads meet ANSI/ASME A112.18.1 flow requirements of maximum 2.5 GPM

# TUB & SHOWER // Sets

## TUB & SHOWER SETS





	Model#	Description	Finish	Case	Price
	0926	Two Handle Shower Set Canopy Handles Shower Head, Arm & Flange 1/2" IP or copper Sweat Union Inlets Replaceable Seats 8" Centers Built-in Transfer Valve, Brass Plug Included	Polished Chrome	8	\$126.25
	80926	Same as 0926 with Ceramic Disc Cartridges	Polished Chrome	8	\$140.75
	0997	Two Handle Tub & Shower Set Canopy Handles Shower Head, Arm & Flange 1/2" IP or copper Sweat Union Inlets Replaceable Seats 8" Centers 1/2" IPS & Slip-on Combo Diverter Tub Spout Built-in Transfer Valve	Polished Chrome	8	\$152.00
	80997	Same as 0997 with Ceramic Disc Cartridges	Polished Chrome	8	\$166.50

Tub & shower sets available in Brushed Nickel.  
Call for pricing and availability.

Central Brass showerheads meet ANSI/ASME A112.18.1 flow requirements of maximum 2.5 GPM

# TUB & SHOWER // Sets

## TUB & SHOWER SETS





	Model#	Description	Finish	Case	Price
	0950	Three Handle Valve Set Canopy Handles 1/2" IP or copper Sweat Union Inlets Replaceable Seats 8" Centers	Polished Chrome	8	\$116.75
	80950	Same as 0950 with Ceramic Disc Cartridges	Polished Chrome	8	\$131.25
  	0968	Three Handle Tub & Shower Set Canopy Handles Shower Head, Arm & Flange 1/2" IP or copper Sweat Union Inlets Replaceable Seats 8" Centers 1/2" IPS Brass Tub Spout	Polished Chrome	8	\$197.90
	0968-Z	With 1/2" IPS & Slip-on Combo Tub Spout	Polished Chrome	8	\$168.25
	80968	Same as 0968 with Ceramic Disc Cartridges	Polished Chrome	8	\$212.40
	80968-Z	Same as 80968 W/ 1/2" IPS & Slip-on Combo Tub Spout	Polished Chrome	8	\$182.75
	0951	Three Handle Valve Set Canopy Handles 1/2" IP or copper Sweat Union Inlets Replaceable Seats 11" Centers	Polished Chrome	8	\$147.25

Tub & shower sets available in Brushed Nickel.  
Call for pricing and availability.

Central Brass showerheads meet ANSI/ASME A112.18.1 flow requirements of maximum 2.5 GPM

# TUB & SHOWER // Sets

## TUB & SHOWER SETS





	Model#	Description	Finish	Case	Price
 	<b>0961</b>	Three Handle Tub Set Canopy Handles 1/2" IP or copper Sweat Union Inlets Replaceable Seats 11" Centers 1/2" IPS Brass Tub Spout	Polished Chrome	8	\$196.75
	<b>0961-Z</b>	With 1/2" IPS & Slip-on Combo Tub Spout	Polished Chrome	8	\$166.75
  	<b>0971</b>	Three Handle Tub & Shower Set Canopy Handles Shower Head, Arm & Flange 1/2" IP or copper Sweat Union Inlets Replaceable Seats 11" Centers 1/2" IPS Brass Tub Spout	Polished Chrome	8	\$228.00
	<b>0971-Z</b>	With 1/2" IPS & Slip-on Combo Tub Spout	Polished Chrome	8	\$198.00
	<b>80971</b>	Same as 0971 with Ceramic Disc Cartridges	Polished Chrome	8	\$242.50
	<b>80971-Z</b>	Same as 80971 W/ 1/2" IPS & Slip-on Combo Tub Spout	Polished Chrome	8	\$212.50

Tub & shower sets available in Brushed Nickel.  
Call for pricing and availability.

Central Brass showerheads meet ANSI/ASME A112.18.1 flow requirements of maximum 2.5 GPM

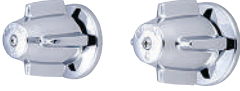
# TUB & SHOWER // Sets

## TUB & SHOWER SETS

	Model#	Description	Finish	Case	Price
	6056	Two Handle Valve Set Canopy Handles 1/2" IP or copper Sweat Union Inlets Replaceable Seats 6" Centers Built-in Transfer Valve, Brass Plug Included	Polished Chrome	8	\$86.50
	6086-Z	Two Handle Tub Set Canopy Handles 1/2" IP or copper Sweat Union Inlets Replaceable Seats 6" Centers 1/2" IPS & Slip-on Combo Tub Spout Built-in Transfer Valve, Brass Plug Included	Polished Chrome	8	\$106.75
	6266	Two Handle Shower Set Canopy Handles Shower Head, Arm & Flange 1/2" IP or copper Sweat Union Inlets Replaceable Seats 6" Centers Built-in Transfer Valve, Brass Plug Included	Polished Chrome	8	\$117.25
	6076	Two Handle Tub & Shower Set Canopy Handles Shower Head, Arm & Flange 1/2" IP or copper Sweat Union Inlets Replaceable Seats 6" Centers 1/2" IPS & Slip-on Combo Diverter Tub Spout Built-in Transfer Valve	Polished Chrome	8	\$143.00

Tub & shower sets available in Brushed Nickel.  
Call for pricing and availability.

Central Brass showerheads meet ANSI/ASME A112.18.1 flow requirements of maximum 2.5 GPM

# TUB & SHOWER // Trim Kits





## TUB & SHOWER TRIM KITS



Canopy Handle

Cross Handle (C3)







Lever Handle (L3)

	Model#	Description	Finish	Case	Price
	TC-2 (Canopy Option Left)	Two Handle Tub And Shower Trim Kit Canopy Handles & Escutcheons Shower Head, Arm & Flange 1/2" IPS Slip-on Combo Diverter Tub Spout	Polished Chrome	6	\$51.10
	TC-2-BN		PVD Brushed Nickel	6	\$83.30
	TCR-2*	*With repair kits K-3-CT	Polished Chrome	6	\$61.10
	TCR-2-BN*		PVD Brushed Nickel	6	\$93.30
	 TC-2-L3 (Lever Option Left)	Same as TC-2 with Lever Handles, Dual Function Shower Head, Cuttable Corner Stems & Nipples	Polished Chrome	6	\$180.30
	TC-2-L3-BN		PVD Brushed Nickel	6	\$188.00
	TC-2-C3	Same as TC-2 with Cross Handles, Dual Function Shower Head, Cuttable Corner Stems & Nipples	Polished Chrome	6	\$193.70
	TC-2-C3-BN		PVD Brushed Nickel	6	\$200.70
	TC-3 (Canopy Option Left)	Three Handle Tub And Shower Trim Kit Canopy Handles & Escutcheons Shower Head, Arm & Flange 1/2" IPS & Slip-on Combo Tub Spout	Polished Chrome	6	\$68.70
	TC-3-BN		PVD Brushed Nickel	6	\$103.70
	TCR-3*	*With repair kits K-3-CT / K-3-DT	Polished Chrome	6	\$78.70
	TCR-3-BN*		PVD Brushed Nickel	6	\$113.70

All L3 Lever Handles for Central Brass Tub & Showers are ADA Compliant  
Central Brass showerheads meet ANSI/ASME A112.18.1 flow requirements of maximum 2.5 GPM

# TUB & SHOWER // Trim Kits





## TUB & SHOWER TRIM KITS

	Model#	Description	Finish	Case	Price	
	 TC-3-L3 (Lever Option Left)	Same as TC-3 with Lever Handles, Dual Function Shower Head, Cuttable Corner/ Diverter Stems & Nipples	Polished Chrome	6	\$229.80	
	TC-3-L3-BN		PVD Brushed Nickel	6	\$232.20	
		TC-3-C3	Same as TC-3 with Cross Handles, Dual Function Shower Head, Cuttable Corner/ Diverter Stems & Nipples	Polished Chrome	6	\$240.70
		TC-3-C3-BN		PVD Brushed Nickel	6	\$251.45
		T-3	Three Handle Trim Kit Canopy Handles & Escutcheons	Polished Chrome	6	\$48.30
		T-3-BN		PVD Brushed Nickel	6	\$63.10
 T-3-L3		Same as T-3 with Lever Handles, Cuttable Corner/ Diverter Stems & Nipples	Polished Chrome	6	\$145.00	
T-3-L3-BN			PVD Brushed Nickel	6	\$154.50	
		T-3-C3 (Cross Option Left)	Same as T-3 with Cross Handles, Cuttable Corner/ Diverter Stems & Nipples	Polished Chrome	6	\$164.00
		T-3-C3-BN		PVD Brushed Nickel	6	\$173.00
		TR-3*	*With repair kits K-3-CT/ K-3-DT	Polished Chrome	6	\$58.30
		TR-3-BN*		PVD Brushed Nickel	6	\$73.10
		T-2	Two Handle Trim Kit Canopy Handles & Escutcheons	Polished Chrome	6	\$28.60
		T-2-BN		PVD Brushed Nickel	6	\$39.50
	 T-2-L3 (Lever Option Left)	Same as T-2 with Lever Handles, Cuttable Corner Stems & Nipples	Polished Chrome	6	\$97.00	
	T-2-L3-BN		PVD Brushed Nickel	6	\$103.00	
		T-2-C3	Same as T-2 with Cross Handles, Cuttable Corner Stems & Nipples	Polished Chrome	6	\$109.00
		T-2-C3-BN		PVD Brushed Nickel	6	\$115.50
		TR-2*	*With repair kits K-3-CT	Polished Chrome	6	\$39.60
		TR-2-BN*		PVD Brushed Nickel	6	\$49.50

All L3 Lever Handles for Central Brass Tub & Showers are ADA Compliant  
Central Brass showerheads meet ANSI/ASME A112.18.1 flow requirements of maximum 2.5 GPM

# TUB & SHOWER // Specialty Products

## TUB & SHOWER SPECIALTY PRODUCTS

	Model#	Description	Finish	Case	Price
	1379	Two Handle Exposed Shower Set 4-Arm Handle 22-1/2" High Brass Riser Replaceable Seats 6" Centers Shower Head 1/2" IP or copper Sweat Union Inlets	Polished Chrome	6	\$218.00
	1379-L	Two Handle Exposed Valve Set 4-Arm Handle Replaceable Seats 6" Centers 1/2" IP or copper Sweat Union Inlets	Polished Chrome	6	\$152.00
	1380	Two Handle Exposed Shower Set 4-Arm Handle 22-1/2" High Brass Riser Replaceable Seats 8" Centers Shower Head 1/2" IP or copper Sweat Union Inlets	Polished Chrome	6	\$234.50
	1380-L	Two Handle Exposed Valve Set 4-Arm Handle Replaceable Seats 8" Centers 1/2" IP or copper Sweat Union Inlets	Polished Chrome	6	\$170.50

Central Brass showerheads meet ANSI/ASME A112.18.1 flow requirements of maximum 2.5 GPM

# TUB & SHOWER // Specialty Products





## TUB & SHOWER SPECIALTY PRODUCTS

	Model#	Description	Finish	Case	Price
	0477	Two Handle Utility Shower Lever Handles	Rough Brass	4	\$105.00
	0477-RC	22-1/2" High Galvanized Riser 1/2-14 NPSF (Dryseal) Female Inlets Shower Head and Soap Dish 3-1/2" Centers 1/2" IP or copper Sweat Union Inlets	Rough Chrome	4	\$110.00
	0206	Two Handle Leg Tub Faucet Canopy Handles 3/4-14 NPS Male Inlets Replaceable Seat 2-Hole 3-3/8" Installation	Polished Chrome	6	\$58.50
	0208	Two Handle Leg Tub Faucet Canopy Handles 6-7/8" High Gooseneck Spout 3/4-14 NPS Male Inlets Replaceable Seat 2-Hole 3-3/8" Installation	Polished Chrome	6	\$71.00
	0209	Two Handle Leg Tub Faucet Canopy Handles 8-1/2" High Gooseneck Spout 3/4-14 NPS Male Inlets Replaceable Seat 2-Hole 3-3/8" Installation	Polished Chrome	6	\$80.50

Central Brass faucets feature aerators that meet ANSI/ASME A112.18.1 flow requirements of 1.75 GPM



# TUB & SHOWER // Specialty Products

## TUB & SHOWER SPECIALTY PRODUCTS

	Model#	Description	Finish	Case	Price
	0210	Two Handle Leg Tub Faucet Round Metal Handles 3/4-14 NPS Male Inlets Replaceable Seat 2-Hole 3-3/8" Installation Adjustable Flanges	Polished Chrome	6	\$71.00
	0210-Q	Two Handle Leg Tub Faucet 4-Arm Handles 3/4-14 NPS Male Inlets Quarter-Turn Stems Replaceable Seat 2-Hole 3-3/8" Installation Adjustable Flanges	Polished Chrome	6	\$72.50
	0211	Two Handle Leg Tub Faucet Round Metal Handles 3/4-14 NPS Male Inlets Replaceable Seat 2-Hole 2-1/2" to 8-1/2" Installation	Polished Chrome	6	\$131.00
	0211-Q	Two Handle Leg Tub Faucet 4-Arm Handles 3/4-14 NPS Male Inlets Quarter-Turn Stems Replaceable Seat 2-Hole 2-1/2" to 8-1/2" Installation	Polished Chrome	6	\$132.50
	1240	Cast Brass Shower Valve Canopy Handles Single By-pass 1/2" IP or copper Sweat Union Inlets Replaceable Seats Threaded Escutcheon	Polished Chrome	6	\$97.50

# TUB & SHOWER // Specialty Products

## TUB & SHOWER SPECIALTY PRODUCTS

	Model#	Description	Finish	Case	Price
	1246	Cast Brass Shower Corner Valve Canopy Handles 1/2-14 NPSF (Dryseal) Female Inlets Replaceable Seats 1/2" IP or copper Sweat Union Inlets	Polished Chrome	6	\$93.50
	0334-1/2	Self-Close Shower Straight Stop Lever Handle 1/2-14 NPS Female Thread Replaceable Seat	Polished Chrome	6	\$70.00
	0335-1/2	Self-Close Shower Straight Stop Lever Handle With 18" Pull Chain 1/2-14 NPS Female Thread Replaceable Seat	Polished Chrome	6	\$72.40
<b>Suffix #</b>	V	Vandal-Resistant Cap		---	\$3.30

# TUB & SHOWER // Bath Drains

## TUB & SHOWER BATH DRAINS

	Model#	Description	Finish	Case	Price
	1645	Multi-Tub Centralift Lift & Turn Drain 20-Guage 1-1/2" Drain Tubes Fits Most Tubs 14" To 16" High	Polished Chrome	6	\$97.60
	1645-17	Multi-Tub Centralift Lift & Turn Drain 17-Guage 1-1/2" Drain Tubes Fits Most Tubs 14" To 16" High	Polished Chrome	6	\$108.00
	1645-CO	Multi-Tub Centralift Lift & Turn Drain Clean-out Ring Fits Most Tubs 14" To 16" High	Polished Chrome	6	\$108.00
	1645-PR	Multi-Tub Centralift Lift & Turn Drain Heavy Pattern Combination Tee (3364) One Additional Slip Nut (3008-BP) & Slip Washer (149-RP) Fits Most Tubs 14" To 16" High Less Tailpiece for Philadelphia Regulation	Polished Chrome	6	\$100.90
	1645-S	Multi-Tub Centralift Lift & Turn Drain With Side Outlet Drain Fits Most Tubs 14" To 16" High	Polished Chrome	6	\$125.90
	1675	Multi-Tub Pop-Up Bath Drain Fits Most Tubs 14" To 16" High	Polished Chrome	6	\$117.20









# TUB & SHOWER // Bath Drains

## TUB & SHOWER BATH DRAINS

	Model#	Description	Finish	Case	Price
	1675-S	Multi-Tub Pop-Up Bath Drain With Side Outlet Drain Fits Most Tubs 14" To 16" High	Polished Chrome	6	\$138.70
	1555	Multi-Tub Trip Lever Bath Drain Light Pattern Cast Brass Tee and Top Ell 20-Gauge 1-1/2" Drain Tubes Fits Most Tubs 14" To 16" High	Polished Chrome	6	\$97.00
	1655	Multi-Tub Trip Lever Bath Drain Heavy Pattern Tee and Top Ell Fits Most Tubs 14" To 16" High	Polished Chrome	6	\$99.80
	1655-P	Multi-Tub Trip Lever Bath Drain Heavy Pattern Tee and Top Ell One Additional Slip Nut (3008-BP) & Slip Washer (149-RP) Fits Most Tubs 14" To 16" High Less Tailpiece for Philadelphia Regulation	Polished Chrome	6	\$99.80
	1655-X	Multi-Tub Trip Lever Bath Drain Heavy Pattern Tee and Top Ell Cast Brass Nuts (3008-X) Fits Most Tubs 14" To 16" High	Polished Chrome	6	\$103.80
	1655-X1817	Multi-Tub Trip Lever Bath Drain Heavy Pattern Tee and Top Ell 18" Overflow Tube & 9-9/16" Shoe Tube Cast Brass Nuts (3008-X) Fits Most Tubs Up To 24" High Fits Many 17-Gauge Whirlpool Tubs	Polished Chrome	6	\$122.70
	1665-WX	Multi-Tub Trip Lever Bath Drain Heavy Pattern Tee and Top Ell Plug Body with Brass Nuts With Weep Holes Fits Most Tubs 14" To 16" High	Polished Chrome	6	\$110.10
	1665-XP17	Multi-Tub Trip Lever Bath Drain Heavy Pattern Tee and Top Ell 17-Gauge 1-1/2" Drain Tubes One Additional Slip Nut (3008-BP) & Slip Washer (149-RP) Fits Most Tubs 14" To 16" High Less Tailpiece for Philadelphia Regulation	Polished Chrome	6	\$127.60



# TUB & SHOWER // Bath Drain Trim Kits

TUB & SHOWER BATH DRAIN TRIM KITS

	Model#	Description	Finish	Case	Price
  	CS-66001	Trim Kit for 1645 Bath Drain Series	Polished Chrome	30	\$35.50
	CS-66001-BN		PVD Brushed Nickel	30	\$38.50
  	CS-66002	Trim Kit for 1675 Bath Drain Series	Polished Chrome	30	\$37.00
	CS-66002-BN		PVD Brushed Nickel	30	\$39.50
  	CS-66003	Trim Kit for 1555 and 1655 Bath Drain Series	Polished Chrome	30	\$31.50
	CS-66003-BN		PVD Brushed Nickel	30	\$33.50
  	CS-66004	Trim Kit for 1665 Bath Drain Series	Polished Chrome	30	\$32.00
	CS-66004-BN		PVD Brushed Nickel	30	\$35.00



# DRINKING FAUCETS // Bubbler Heads

## DRINKING FAUCET / BUBBLER HEADS

	Model#	Description	Finish	Case	Price
	0364-L	Drinking Faucet Self-Close Lever Handle 1/2-14 NPS Male Thread Replaceable Seat	Polished Chrome	6	\$163.40
	0365-L	Drinking Faucet Self-Close Lever Handle 3/8-18 NPS Female Thread Replaceable Seat	Polished Chrome	6	\$158.50
	0366-L	Drinking Faucet-Wallmount Self-Close Lever Handle 3/8-18 NPS Female Thread Replaceable Seat	Polished Chrome	6	\$156.00
<b>Suffix #</b>	V	Vandal-Resistant Cap (Available on 0364-L, 0365-L, and 0366-L)		---	\$3.30

# DRINKING FAUCETS // Bubbler Heads

DRINKING FAUCET / BUBBLER HEADS

	Model#	Description	Finish	Case	Price
	0360	Drinking Faucet Cast Brass Bubbler Head 1/2-14 NPS Male Thread Replaceable Cartridge (K-361) Flange	Polished Chrome	6	\$89.30
	0361	Drinking Faucet Cast Brass Bubbler Head 3/8-18 NPS Female Thread Replaceable Cartridge (K-361) Flange	Polished Chrome	36	\$77.80
	0362	Drinking Faucet Cast Brass Bubbler Head 3/8-18 NPS Female Thread Replaceable Cartridge (K-361)	Polished Chrome	36	\$74.40





# DRINKING FAUCETS // Bubbler Heads

## DRINKING FAUCET / BUBBLER HEADS

	Model#	Description	Finish	Case	Price
	0366-HX8WB	Drinking Fountain-Wallmount Self-Close Lever Handle Brass Round Bowl, Brushed Finish 3/8-18 NPS Female Thread W/Wall Bracket Replaceable Seat	Polished Chrome	6	\$285.50
	0366-HX8WBD	0366-HX8WB with Drain Adapter 3/8" to 1-1/4"	Polished Chrome	6	\$307.00
	0366-HX8	Drinking Fountain-Wallmount Self-Close Lever Handle Brass Round Bowl, Brushed Finish 3/8-18 NPS Female Thread Replaceable Seat	Polished Chrome	6	\$248.80
<b>Suffix #</b>	<b>V</b>	Vandal-Resistant Cap		---	\$3.30
	0376	Drinking Faucet-Head 3/8-18 NPS Female Thread Less Stream Control	Polished Chrome	12	\$37.00
	0377	Drinking Faucet-Head 3/8-18 NPS Female Thread With Stream Control	Polished Chrome	12	\$61.80
	0425	Gravity Faucet Push Button 3/8-18 NPS Male Thread	Polished Chrome	40	\$28.60
	0426	Gravity Faucet Push Button 3/8-18 NPS Female Thread	Polished Chrome	40	\$21.90



# SPECIALTY // Wallmount Single Handle Faucets

## WALLMOUNT SINGLE HANDLE FAUCETS

	Model#	Description	Finish	Case	Price
	0005-H1/2P	Single Handle Wallmount Faucet 4-Arm Handle Hose Thread 1/2-14 NPT Female Thread Replaceable Seat 1-Hole Wallmount Adjustable Flange	Polished Chrome	6	\$60.50
	0006-H1/2C	Single Handle Wallmount Faucet Lever Handle Hose Thread 1/2-14 NPT Male Thread Replaceable Seat 1-Hole Wallmount Adjustable Flange	Rough Chrome	6	\$44.00
	0006-H1/2H	Single Handle Wallmount Faucet Lever Handle Hose Thread 1/2-14 NPT Male Thread Replaceable Seat 1-Hole Wallmount Adjustable Flange	Rough Chrome	6	\$44.00
	0007-1/2	Single Handle Wallmount Faucet 4-Arm Handle Plain End 1/2-14 NPT Female Thread Replaceable Seat 1-Hole Wallmount Solid Flange	Polished Chrome	6	\$52.50
	0007-H1/2	Single Handle Wallmount Faucet 4-Arm Handle Hose Thread 1/2-14 NPT Female Thread Replaceable Seat 1-Hole Wallmount Solid Flange	Polished Chrome	6	\$55.00



# SPECIALTY // Self-Closing Faucets

## SELF-CLOSING WALLMOUNTS & STOPS

	Model#	Description	Finish	Case	Price
	0033-1/2CV-02	Self-Close Wallmount Faucet	Polished Chrome	6	\$110.00
	0033-1/2PV-02	4-Arm Vandal Proof Handle Plain End	Polished Chrome	6	\$110.00
	0033-1/2HV-02	1/2-14 NPT Female Thread Replaceable Seat 1-Hole Wallmount Solid Flange	Polished Chrome	6	\$110.00
	0031-H1/2C	Self-Close Wallmount Faucet	Rough Chrome	6	\$80.20
	0031-H1/2P	4-Arm Handle Hose Thread	Rough Chrome	6	\$80.20
	0031-H1/2H	1/2-14 NPT Male Thread Replaceable Seat 1-Hole Wallmount	Rough Chrome	6	\$80.20



# SPECIALTY // Self-Closing Faucets

## SELF-CLOSING WALLMOUNTS & STOPS

	Model#	Description	Finish	Case	Price
	0331-3/8	Self-Close Straight Stop 4-Arm Handle 3/8-18 NPS Female Thread Replaceable Seat	Polished Chrome	6	\$68.00
	0331-1/2	Self-Close Straight Stop 4-Arm Handle 1/2-14 NPS Female Thread Replaceable Seat	Polished Chrome	6	\$69.40
	0331-L3/8	Self-Close Straight Stop Lever Handle 3/8-18 NPS Female Thread Replaceable Seat	Polished Chrome	6	\$70.00
	0331-L1/2	Self-Close Straight Stop Lever Handle 1/2-14 NPS Female Thread Replaceable Seat	Polished Chrome	6	\$71.00
	0333-3/8	Self-Close Angle Stop 4-Arm Handle 3/8-18 NPS Female Thread Replaceable Seat	Polished Chrome	6	\$70.90
	0333-1/2	Self-Close Angle Stop 4-Arm Handle 1/2-14 NPS Female Thread Replaceable Seat	Polished Chrome	6	\$71.90
	0333-L3/8	Self-Close Angle Stop Lever Handle 3/8-18 NPS Female Thread Replaceable Seat	Polished Chrome	6	\$72.90
	0333-L1/2	Self-Close Angle Stop Lever Handle 1/2-14 NPS Female Thread Replaceable Seat	Polished Chrome	6	\$73.50
<b>Suffix #</b>	<b>V</b>	Vandal-Resistant Cap		---	\$3.30
	0336-N2-3/8	Slow-Close Straight Stop Push Handle 3/8-18 NPS Female Thread (External Cycle Adjustment on Handle)  <b>Note:</b> New ADA Compliant Cartridge and Handle Kit (CS-49016C,H,P) Fits Old Slow Close Faucets.	Polished Chrome	6	\$77.50
	0336-N2-1/2	Slow-Close Straight Stop Push Handle 1/2-14 NPS Female Thread (External Cycle Adjustment on Handle)  <b>Note:</b> New ADA Compliant Cartridge and Handle Kit (CS-49016C,H,P) Fits Old Slow Close Faucets.	Polished Chrome	6	\$79.50



# SPECIALTY // Valves

## SPECIALTY VALVES

	Model#	Description	Finish	Case	Price
	0555	Alliance Anti-Sweat Temperature Valve for Water Closet Tanks Cast Brass Body 3/8-18 NPT Male Taper Thread Check Valves	Rough Brass	36	\$44.50
	0555-D	Alliance Anti-Sweat Temperature Valve for Water Closet Tanks Cast Brass Body 3/8-18 NPT Male Taper Thread Check Valves With Drains	Rough Brass	36	\$47.50
	0607-C1/2	Tile Stop Valve 3-Point Handle	Polished Chrome	6	\$41.00
	0607-C3/4*	1/2" Direct Sweat Inlet/Outlet  *3/4-Inch Direct Sweat Inlets	Polished Chrome	6	\$42.00





# SPECIALTY // Lawn Faucets

## SPECIALTY LAWN FAUCETS

	Model#	Description	Finish	Case	Price
	0575-1/2	Lawn Faucet Wheel Handle	Rough Brass	6	\$38.00
	0575-1/2CP	Cast Brass Body, Hose Thread 1/2-14 NPS Female Thread Flange	Polished Chrome	6	\$64.00
	0576-1/2	Lawn Faucet Loose Key Handle	Rough Brass	6	\$38.00
	0576-1/2CP	Cast Brass Body, Hose Thread 1/2-14 NPS Female Thread Lockshield Type Flange	Polished Chrome	6	\$64.00
	0576-3/4	Lawn Faucet Loose Key Handle Cast Brass Body, Hose Thread 3/4-14 NPS Female Thread Lockshield Type Flange	Rough Brass	6	\$38.00



# SPECIALTY // Shampoo Faucets

## SPECIALTY SHAMPOO FAUCETS

	Model#	Description	Finish	Case	Price
	 1130	Single Handle Shampoo Faucet Lever Handle Ceramic Disc Cartridge W/Temperature Limit Stop Back-flow Preventers Included 2-Hole 4" to 18" Installation Pull-out Dual Pattern Sprayhead W/60" Heavy Duty Rubber Hose Pull-out Dual Pattern Sprayhead 2.0 GPM Flow Rate	Polished Chrome	6	\$114.60
	 1131-B	Two Handle Shampoo Faucet Canopy Handles	Polished Chrome	6	\$78.50
	1132-B*	35 Degree Bottom Outlet Supply Tube 1/2-14 NPS Male Inlets x 1-7/8" Long Replaceable Seats 3-Hole 4" Installation  *3-3/8-Inch Centers	Polished Chrome	6	\$88.50
	CS-45002	Pull Out Spray Head and Hose Kit for 1130 Pull-out Dual Pattern Sprayhead W/60" Heavy Duty Rubber Hose	Polished Chrome	1	\$40.50
	CS-45003	Hose Guide and Mounting Kit for 1130	Polished Chrome	1	\$15.50





# ACCESSORIES

ACCESSORIES

	Model#	Description	Finish	Case	Price
	0342-3/8	Stand Pipe 3/8-18 NPT Male Thread Nut & Flange	Polished Chrome	6	\$19.50
	0342-1/2	Stand Pipe 1/2-14 NPT Male Thread Nut & Flange	Polished Chrome	6	\$20.00
	0342-1/2VB	Stand Pipe 1/2-14 NPT Male Thread Nut & Flange Vacuum Breaker  <b>Note:</b> For use with 0331-1/2, 0333-1/2, and 0336-1/2	Polished Chrome	6	\$65.60
	1109	Brass Pop-Up Drain Assembly With Guide With Over-Flow Drain Upper & Lower Pull Rods	Polished Chrome	12	\$40.00
	1109-LG	Brass Pop-Up Drain Assembly Less Guide With Over-Flow Drain Upper & Lower Pull Rods	Polished Chrome	12	\$37.50
	1109-BP	Brass Pop-Up Drain Assembly With Guide Without Over-Flow Drain Upper & Lower Pull Rods	Polished Chrome	12	\$50.00
	1109-BPLG	Brass Pop-Up Drain Assembly Less Guide Without Over-Flow Drain Upper & Lower Pull Rods	Polished Chrome	12	\$46.00
<b>PARTS</b>	G-195-DST9	Ball Lever Rod Group for 1109	---	1	\$7.75
	3105	Vandal-Resistant Grid Drain With Over-Flow Drain 17-Gauge Tailpiece	Polished Chrome	10	\$22.00
	3105-BP	Vandal-Resistant Grid Drain Without Over-Flow Drain 17-Gauge Tailpiece	Polished Chrome	10	\$23.00

# ACCESSORIES

## ACCESSORIES

	Model#	Description	Finish	Case	Price
	3106	Vandal-Resistant Grid Drain Offset for Wheelchair Access 17-Gauge Tailpiece	Polished Chrome	10	\$44.00
	G-1748-88W	Swivel Spout Adapter Allows for Topmount Faucets to be Mounted on Splash Back	Polished Chrome	10	\$14.60
	SU-2775-R-02	Double-Joint Swing Spout 7" C to C Heavy Cast Brass Construction Ideal for Three Compartment Sinks	Polished Chrome	10	\$42.00
	0112-AL	Overflow Socket Drain 1-11 1/2 NPS Shank X 1-7/8" Long	Polished Chrome	36	\$19.00

# **2018 CENTRAL BRASS SPOUTS & HANDLES CHARTS**

# CHARTS // Spouts

## KITCHEN / LAVATORY HANDLE CONFIGURATION OPTIONS

**SU-363-RA**

8" Swivel Tube Spout with Aerator

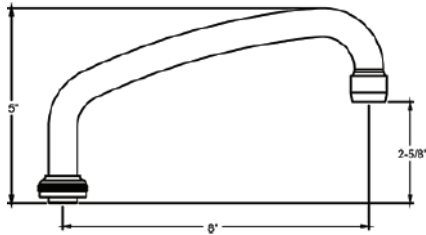

**SU-363-JA**

10" Swivel Tube Spout with Aerator

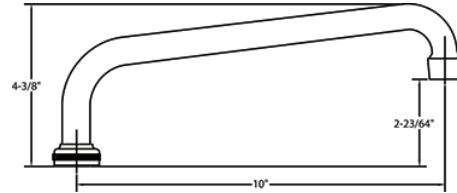

**SU-363-LA**

12" Swivel Tube Spout with Aerator

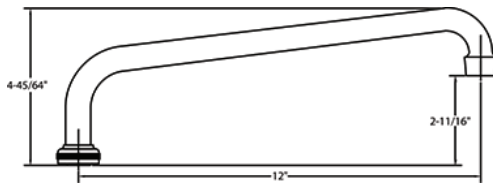

**SU-363-MA**

14" Swivel Tube Spout with Aerator

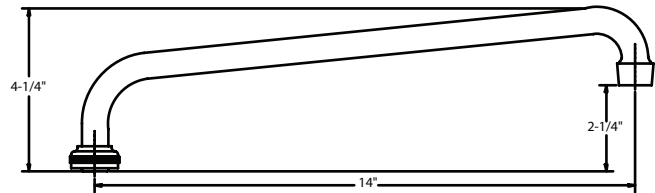

**CS-22004**

16" Swivel Tube Spout With Aerator

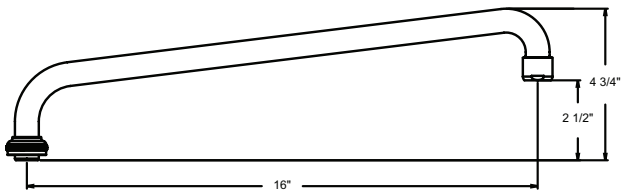

**CS-22005**

18" Swivel Tube Spout With Aerator

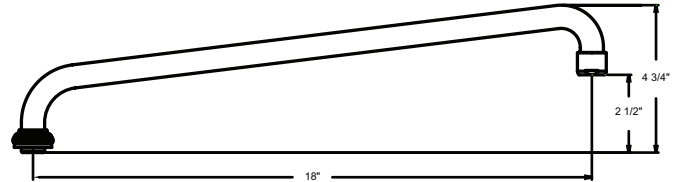

**SU-2929-01**

6" Hose End Cast Swivel Spout

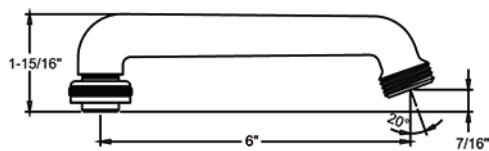

**SU-365-CA**

8" Brass Swivel "D" Spout with Aerator

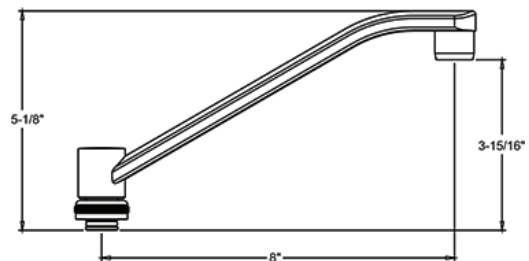

# CHARTS // Spouts

## KITCHEN / LAVATORY HANDLE CONFIGURATION OPTIONS

### SU-2923-A

5" Cast Brass Swivel Spout with Aerator

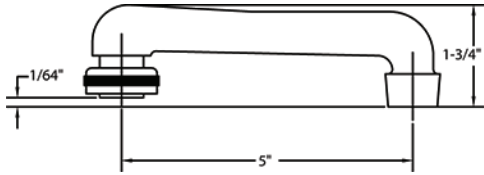

### SU-2775-R-02

7" Cast Brass Spout Extension Polished Chrome

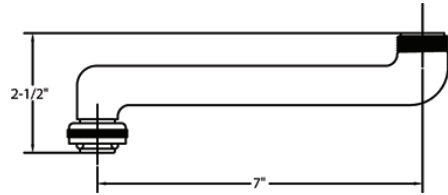

### SU-2924-A

6" Tube Spout with Aerator

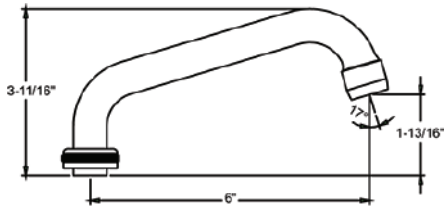

### SU-157-GRA

4-3/32" Rigid Gooseneck Spout with Aerator

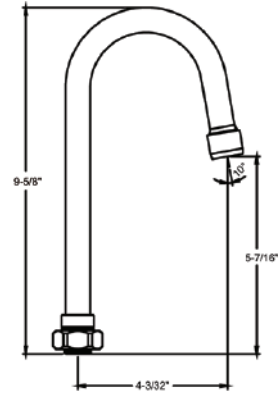

### SU-157-GSA

4-3/32" Swivel Gooseneck Spout with Aerator

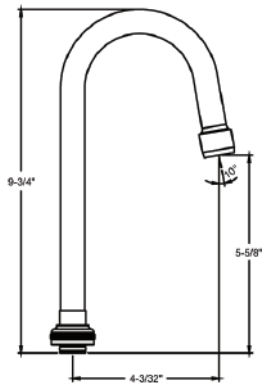

### CS-25001 (GSA1)

4-3/32" Swivel Gooseneck Spout with Aerator

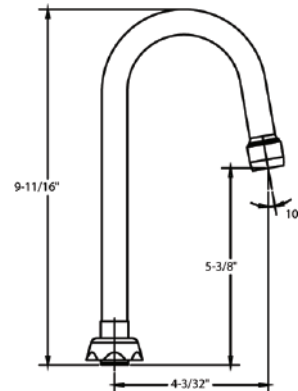

# CHARTS // Spouts

## KITCHEN / LAVATORY HANDLE CONFIGURATION OPTIONS

### CS-22002

4-3/32" Combo Rigid/Swivel Gooseneck Spout With Aerator

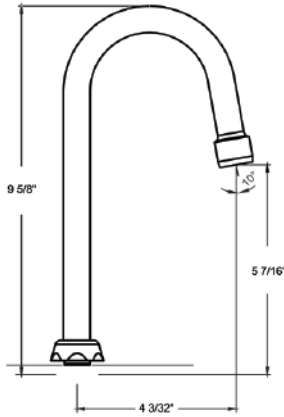

### CS-22003

5-1/2" Combo Rigid/Swivel Gooseneck Spout With Aerator

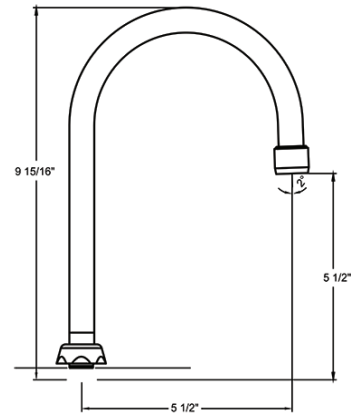

### SU-157-KRA

5-1/2" Rigid Gooseneck Spout with Aerator

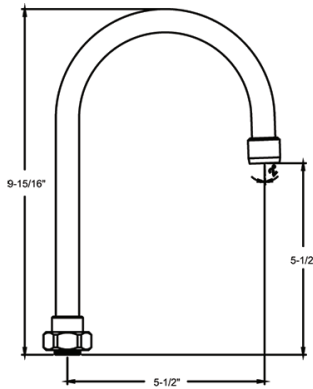

### SU-157-KSA

5-1/2" Swivel Gooseneck Spout with Aerator

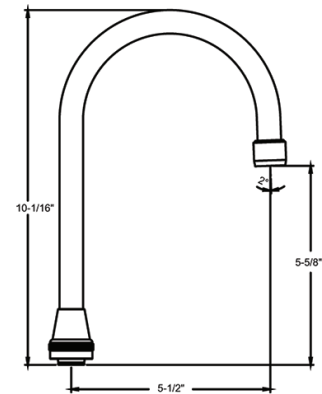

### SU-257-TSA

6-3/8" Swivel Tri-Arc Gooseneck Spout with Aerator

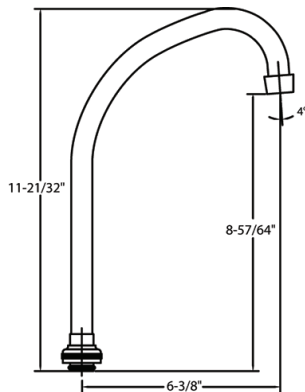

### CS-22001 (TSA1)

6-3/8" Swivel Tri-Arc Gooseneck Spout with Aerator

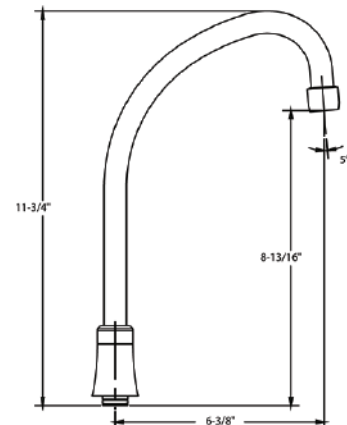

# CHARTS // Spouts

## KITCHEN / LAVATORY HANDLE CONFIGURATION OPTIONS

### SU-357-HSA

7-1/4" Swivel High Rise Spout with Aerator

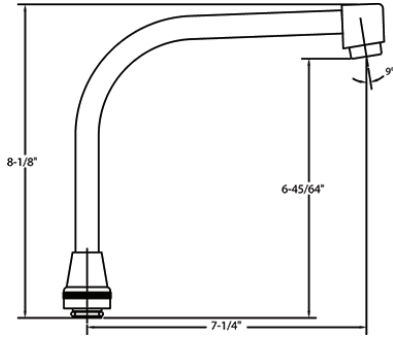

### SU-357-WSA

8-3/4" Swivel Gooseneck Spout with Aerator

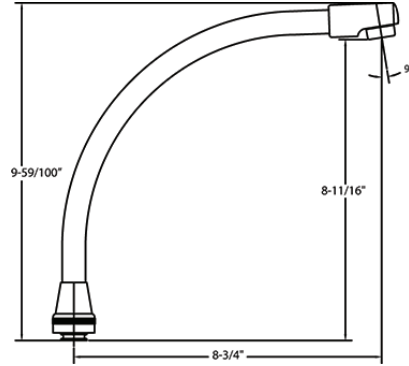

# CHARTS // Handles

## KITCHEN / LAVATORY HANDLE CONFIGURATION OPTIONS

K-512-02  
K-512-15



G-518-C  
G-518-H



G-523-C  
G-523-H



G-4147-C  
G-4147-H



G-4149-C  
G-4149-H



G-398-C  
G-398-H



CS-19003C  
CS-19003H



CS-19004C  
CS-19004H



CS-19001C  
CS-19001H



CS-19002C  
CS-19002H



CS-19007C  
CS-19007H



## SELF CLOSE / METERING HANDLE CONFIGURATION OPTIONS

G-7116-V\*



PF-7114-P\*



G-6928-V\*



PF-7114-PS\*



\*Cap Sold Separately

# CHARTS // Handles

## SINGLE BASIN HANDLE CONFIGURATION OPTIONS

G-520-W

G-1043

CS-13001C

CS-13001P

CS-13001H



## TUB & SHOWER HANDLE CONFIGURATION OPTIONS

G-521-BWC\*

G-521-BWD\*

G-521-BWH\*

CS-14002C

CS-14002P

CS-14002H

CS-14001C

CS-14001P

CS-14001H

G-508-C\*

G-508-H\*

G-508-D\*



\*Escutcheons Sold Separately

# MISCELLANEOUS // Parts

Part#	Where Used	PCS/ CS	Price
<b>Replacement For Compression Units Only</b>			
 <b>K-453-C K-453-H</b>	Stem Assembly w/ Replaceable Seat For Topmounts, Centersets, Wall Mounts, Utility Shower, Bar and Laundry Faucets-Cold, Hot	1	\$11.00
 <b>G-453-EL G-453-ER</b>	Stem Assembly For Topmounts, Centersets, Wall Mounts, Utility Shower, Bar and Laundry Faucets-Cold, Hot	1	\$9.50
 <b>G-458-KL G-458-KR</b>	Stem Assembly For Shelf/ Slant Back Faucets-Cold, Hot	1	\$17.20
 <b>SU-1548-605</b>	Stem Assembly For Tile Stop Valve (0607)	1	\$21.50
 <b>SU-1839-P</b>	Stem Assembly For Lawn Faucet (0575, 0576)	1	\$21.50
 <b>SU-1839-PRC</b>	Stem Assembly For Lawn Faucet (0575CP/RC, 0576CP/RC)	1	\$23.10
 <b>SU-1855-47RPRC</b>	Stem Assembly For Single Hole Wallmount Faucets (0005,0006,0007,0009)	1	\$13.00
 <b>XSU-1858-A</b>	Stem Assembly For Single Basin Faucet (0239)-2/pk	2	\$22.50
 <b>K-2-CT</b>	Stem Assembly W/Replaceable Seat For Washer Machine Filler & Single By-Pass & Shower Corner Valve	1	\$32.00
 <b>K-2-DT</b>	Diverter Stem Assembly W/ Replaceable Seat For Old Style Three Handle Tub/ Shower Valve	1	\$57.10
 <b>K-3-CT</b>	Stem Assembly W/Replaceable Seat For Two & Three Handle Tub/Shower Valve	1	\$20.50
 <b>K-3-DT</b>	Diverter Stem Assembly W/ Replaceable Seat For Three Handle Tub/Shower Valve	1	\$21.00
<b>Replacement For 0360,0361,0362</b>			
 <b>K-361</b>	Stem Assembly For Drinking Faucets (0360, 0361, 0362)	1	\$40.60

Part#	Where Used	PCS/ CS	Price
<b>Replacement For Ceramic Units Only</b>			
 <b>K-352-C K-352-H</b>	Ceramic Stem Assembly For Topmounts, Centersets, Wall Mounts, Utility Shower, Bar and Laundry Faucets-Cold, Hot	1	\$30.50
 <b>CS-39001</b>	Ceramic Disc Cartridge For Single Handle Shampoo Faucet (1130)	1	\$9.50
 <b>K-351-C K-351-H</b>	Ceramic Stem Assembly For Two & Three Handle Tub/Shower Valve-Cold, Hot	1	\$39.50
 <b>CS-34001C CS-34001H</b>	Ceramic Stem Assembly For Two & Three Handle Tub/ Shower Valve-Cold, Hot (C3 & L3 Suffix)	1	\$27.00
 <b>CS-34001V</b>	Diverter Stem Assembly W/ Replaceable Seat For Three Handle Tub/Shower Valve (C3 & L3 Suffix)	1	\$21.50
<b>Replacement For Quick Pression 1/4 Turn Units Only</b>			
 <b>G-454-EL G-454-ER</b>	Quick Pression 1/4 Turn Stem Assembly For Topmounts, Centersets, Wall Mounts, Utility Shower, Bar and Laundry Faucets-Cold, Hot	1	\$10.00
<b>Replacement For Metering (Slow-Close) Units Only</b>			
 <b>CS-49016C CS-49016H</b>	Metering (Slow-Close) Cartridge W/Cold / Hot Handle For Old Or New Metering (Slow-Close) Faucets	1	\$37.00
 <b>CS-49016P</b>	Metering (Slow-Close) Cartridge W/Plain Handle For Old Or New Metering (Slow-Close) Faucets	1	\$37.00
 <b>CS-49017C CS-49017H</b>	Metering (Slow-Close) Cartridge W/Cold / Hot Handle For Old Or New Wide-spread Metering (Slow-Close) Faucets	1	\$36.50
 <b>CS-39004</b>	Metering (Slow-Close) Cartridge For New Metering (Slow-Close) Faucets (N2 & N1 Suffix)	1	\$33.00
<b>Replacement For Self-Close Units Only</b>			
 <b>CS-39002</b>	Self-Closing Stem Assembly For Drinking, Wallmounts/ Stops Faucets	1	\$49.50
 <b>CS-39003</b>	Self-Closing Stem Assembly For Lavatory (1167), Wallmounts/Stops (0031, 0033) Faucets	1	\$66.50



## PARTS

Part #	Description	PCS/ CS	List Price
X3	Brass Washer-6/pk	6	\$4.00
X4	Brass Packing Washer -6/pk	6	\$4.00
X4-L	Brass Packing Washer-6/pk	6	\$2.00
X4-MA	Nylon Washer-6/pk	6	\$2.00
X4-N	Celcon Washer for Diverter Stem-6/pk	6	\$1.50
G-21	Rod & Knob with Cotter Pins	1	\$9.50
X22	Brass Washer-6/pk	6	\$2.00
X28-A	Brass Washer for Widespread Spout with Hole for Pop-Up Pull Rod-6/pk	6	\$2.25
G-29-A	Flush Valve Group	1	\$15.10
CS-49032	2 Combo Union Nuts & Sleeve	1	\$14.00
G-30-C	2 Copper Union Nuts & 2 Sleeves	1	\$13.50
X33-A	Brass Washer-6/pk	6	\$2.00
X42	Klingersil Gasket-6/pk	6	\$3.50
X53-AS	Zinc Die Cast Locknut-6/pk	6	\$7.00
X53-AZ	Zinc Locknut for Shelf/Slant Back Lavatory Faucet-6/pk	6	\$6.90
X53-CZ	Zinc Die Cast Locknut-6/pk	6	\$7.50
X54	Thinner Crowfoot Steel Washer-10/pk	10	\$3.00
XPF-59	Brass Seat RC-10/pk	10	\$13.00
61-LC	Linkage (5-3/8")	1	\$3.50
SU-61-LC	5-3/8" Linkage	1	\$8.00
SU-61-LCPP	5-3/8" Linkage with Plunger for 1555	1	\$17.00
SU-61-LDP	6-3/16" Linkage with Plunger for 1655/1655X	1	\$32.00
SU-61-LEP	Linkage for 1655-X1817 Bath Drain	1	\$31.50
61-LU	Clevis	1	\$2.50
XPF-67-AC	Celcon Samson Nut for Self-Closing Handles-10/pk	10	\$5.00
X68-HX	Brass Square Nut for Slow-Close & Self-Closing Handles-10/pk	10	\$8.00
X69-C	Celcon Sleeve for Slow-Close & Self-Closing Handles-10/pk	10	\$3.00
X70-WA	Brass Hole Button for Items Without Pop-Up Drain-6/pk	6	\$6.25
X71	Brass Ball Retainer-2/pk	2	\$13.50
X82-J	Brass Packing Washer for Stem Assembly-6/pk	6	\$2.00
G-83-ACZ*	Faceplate For Lift & Turn or Chain With Stopper Bath Drains	1	\$10.00
G-83-AZ	Faceplate For Trip Lever or Pop-Up Bath Drains	1	\$22.00
SU-83-AZ	Trip Lever Face Plate	1	\$15.80
SU-85-APF	Rocker Arm Assembly with Flat Platform End	1	\$12.00
SU-85-FA	8-3/4" Linkage with Spring for 1676 Series	1	\$15.00
85-FW	Steel Wrench	1	\$1.00

\*Will be obsolete when present stock is depleted

Part #	Description	PCS/ CS	List Price
SU-85-K	13-3/4" Linkage with Spring for 1675 Series	1	\$13.00
SU-85-KM	6-1/2" Linkage with Spring for 1674 Series	1	\$14.00
X85-U	2-11/16" Brass Eyebolt for Bath Drain Linkage & Plumber Groups-2/pk	2	\$2.00
SU-85-U	Clevis Assembly	1	\$5.50
G-94-F	Knob & Screw for Lift & Turn Bath Drains	1	\$2.50
G-95-A	Coupling Nuts & Washer (1 Set) (Thinner Crowfoot Washer)	1	\$3.00
G-97	Locknut Group-2/pk	1	\$3.00
X103-HS	Set Screw 3/16" Long 10-32-6/pk	6	\$2.00
X103-HSSS	Set Screw 1/18" Long-6/pk	6	\$2.00
X103-PLCP	Flat Head Knob Screw Phillips-6/pk	6	\$3.00
X104	Round Head Seat Washer Screw-25/pk	25	\$3.00
X105	Round Head Seat Washer Screw Slotted-25/pk	25	\$3.00
X105-H	Round Head Screw Slotted-6/pk	6	\$3.00
X107-F	Oval Head Handle Screw Phillips-25/pk	25	\$4.50
X107-FB	Color Code Index Ring-Blue-5/pk	5	\$3.00
X107-FR	Color Code Index Ring-Red-5/pk	5	\$3.00
X107-H	Oval Head Screw for 398/518 Handle Phillips-6/pk	6	\$3.00
X113-P	Hex Head Pop-Up Bracket Screw-6/pk	6	\$1.00
X126-S	Truss Head Screw-6/pk	6	\$0.75
X127-AP21/4	Face Plate Screw for Bath Drain Phillips-6/pk	6	\$6.50
G-128-52	Screw	2	\$2.00
SU-157-DA	4-3/16" Rigid Gooseneck Spout W/ Aerator	1	\$45.20
SU-157-GRA	4-1/16" Rigid Gooseneck Spout With Aerator	1	\$37.50
SU-157-GLA	3-15/16" Rigid Gooseneck Spout With Aerator for Bar Faucet (For 0289)	1	\$54.50
SU-157-GSA	4-1/16" Swivel Gooseneck Spout With Aerator	1	\$37.00
SU-157-G	3-15/16" Gooseneck Spout With Streamformer for Leg Tub Faucet	1	\$46.50
SU-157-HA	4-11/16" Rigid Gooseneck Spout With Aerator	1	\$59.00
157-I	Riser, Galvanized Gooseneck	1	\$31.50
SU-157-JA	4-15/16" Rigid Gooseneck Spout With Aerator	1	\$63.20
SU-157-KRA	5-9/16" Rigid Gooseneck Spout With Aerator	1	\$83.50
SU-157-KSA	5-9/16" Swivel Gooseneck Spout With Aerator	1	\$84.00
PF-161-D	Flange for Bubbler Head	1	\$8.10

Note: Order by Number of Packs Required, Not by Individual Pieces

## PARTS

Part #	Description	PCS/ CS	List Price
X165	Brass Seat for Wash Machine Filler & Single By-pass Shower Valve-10/pk	10	\$13.00
X165-6500	Brass Seat-2/pk	2	\$5.00
X166-FN	Snap Ring for Spout-6/pk	6	\$1.00
X166-Q	Snap Ring for CentraLift Bath Drain-6/pk	6	\$2.00
XPF-166-U	Spout End Aerator Adapter-2/pk	2	\$7.00
X168-B	Hex Nut-4/pk	4	\$3.00
PF-177-G	Hose Push on Spout for Leg Tub Faucet	1	\$8.70
X193-LBN	Nylon Gasket for Shelf/Slant Back Stem Assembly-6/pk	6	\$1.50
X194	Cotter Pin For Shelf/Slant Back Faucets Rocker Arm Assembly-6/pk	6	\$1.00
X195-C	Clip for Pop-Up Pull Rod-6/pk	6	\$2.00
X207-B	Brass Hex Nut for Bath Drain-6/pk	6	\$2.50
PF-218-A	Brass Strainer Body for 1555 1655 1685	1	\$12.00
G-218-A	Strainer Group for Item Nos. 1555 & 1655	1	\$14.00
X218-B	Strainer Plate for 1555/1655-10/pk	10	\$6.50
X218-C	Oval Head Brass Strainer Plate Screw-10/pk	10	\$4.00
X218-F	Strainer Plate for 1665-X-2/pk	2	\$6.50
X222-D	Cotter Pin for Trip Lever Face Plater-6/pk	6	\$2.00
XSU-233-B	Chain & Ring for 0335-1/2 Self-Closing Shower Stop-2/pk	2	\$12.10
SU-257-JSA	6-3/8" Triple Radius Spout W/Aerator Must Use W/PF-1012-J Escutcheon	1	\$131.70
SU-257-TSA	6-3/8" Swivel Tri-Arc Gooseneck Spout With Aerator	1	\$92.00
PF-259-X	Brass Soap Dish	1	\$14.00
XPF-263-B	Brass Seat CP-4/pk	4	\$5.00
X263-BC	Seat-10/pk	10	\$13.50
XPF-263-C	Brass Seat RC-2/pk	2	\$6.00
PF-263-D	Seat for Widespread Series	1	\$9.70
SU-266-P	Diverter Piston-Plastic	1	\$5.50
268-TVR	Set-Diverter Piston	1	\$3.00
X269-29/16	2-9/16" Brass Nipple-10/pk	10	\$29.50
X279-D	Brass Washer-10/pk	10	\$2.50
X279-E	Brass Washer-10/pk	10	\$4.00
X279-L	Brass Washer-10/pk	10	\$1.75
X279-V	Spring-10/pk	10	\$3.00
G-284	Locknut & Washer Group	1	\$11.50
312-10N	10" Hose Connector	1	\$15.50
SU-357-HSA	7-1/4" Swivel High Rise Spout With Aerator	1	\$115.00
SU-357-WSA	8-3/4" Swivel Gooseneck Spout With Aerator	1	\$106.00
PF-358-Q	Cap Button for Bubbler Head	1	\$4.00

\*Will be obsolete when present stock is depleted

Part #	Description	PCS/ CS	List Price
PF-358-RS	Cap Nut for Bubbler Head	1	\$9.50
SU-358-SA	Jet Assembly for Bubbler Head	1	\$9.00
X358-U	Fiber Washer-10/pk	10	\$1.50
X358-V	Monel Screen-10/pk	10	\$4.50
SU-363-JA	10" Swivel Tube Spout With Aerator	1	\$36.90
SU-363-JH	10" Swivel Tube Spout With Hose End	1	\$38.45
SU-363-LA	12" Swivel Tube Spout With Aerator	1	\$40.30
SU-363-LH	12" Swivel Tube Spout With Hose End	1	\$41.90
SU-363-MA	14" Swivel Tube Spout With Aerator	1	\$41.40
SU-363-MH	14" Swivel Tube Spout With Hose End	1	\$42.90
SU-363-RA	7-7/8" Swivel Tube Spout With Aerator	1	\$28.70
SU-363-RH	7-7/8" Swivel Tube Spout With Hose End	1	\$30.30
SU-365-CA	8-3/16" Swivel D Style Spout With Aerator	1	\$51.50
SU-365-CH	8-3/16" Swivel D Style Spout With Hose End	1	\$53.50
390	Flange	1	\$7.00
G-392	Brass Cover Plate with Gasket for Item No. 0094	1	\$18.50
PF-398-B8	Brass Bowl for Drinking Fountain	1	\$87.00
G-398-C	Round Fluted Handle With Screw - Cold	1	\$8.00
G-398-H	Round Fluted Handle With Screw - Hot	1	\$8.00
X402-A	Fiber Washer for Stem-25/pk	25	\$2.00
X402-B	Nylon Washer for Self-Closing Stem Assembly-12/pk	12	\$4.00
X409-PT	Ball Lever Packing for Pop-Up-12/pack	12	\$4.00
X420-N	Nylon Washer-12/pk	12	\$2.00
X427-WS	Gasket for Widespread Spout with Hole for Pop-Up Pull Rod-12/pk	12	\$7.00
X433-AN	Nylon Gasket for Self-Closing Stem Assembly-12/pk	12	\$6.00
X491-S	Klingersil Gasket-12/pk	12	\$10.50
X491-U	Klingersil Gasket-12/pk	12	\$7.50
G-508-C	Large Canopy Handle With Screw-Cold	1	\$11.00
G-508-H	Large Canopy Handle With Screw-Hot	1	\$11.00
G-508-D	Large Canopy Handle With Screw-Diverter	1	\$11.00
510	Escutcheon for Item No. 1177	1	\$7.10
SU-511-A	1-11/16" Shelf Back Spout With Aerator	1	\$28.70
G-518-C	Tear Drop Handle With Screw-Cold	1	\$16.50
G-518-H	Tear Drop Handle With Screw-Hot	1	\$16.50
G-520-W	Lever Laundry Faucet Handles Cold & Hot With Screws	1	\$4.95
521-B	Escutcheon	1	\$8.40
G-521-BWD*	3-Point Lever Handle With Screw-Diverter	1	\$8.40
G-523-C	Canopy Handle With Screw-Cold	1	\$6.00

Note: Order by Number of Packs Required, Not by Individual Pieces

## PARTS

Part #	Description	PCS/ CS	List Price
G-523-H	Canopy Handle With Screw-Hot	1	\$6.00
524-B	Escutcheon for Ledge Fittings	1	\$6.00
530	Escutcheon for Ledge Fittings (High Skirt) for Slow-Close Handle Use	1	\$5.50
X700-KT	Brass Nipple for Item 0425 Push Button Gravity Faucet Only-2/pk	2	\$14.10
PF-714-RT	Brass Shower Riser 22-1/2" for Exposed Shower	1	\$154.70
714-WT-02	Shower Arm 6"	1	\$9.50
PF-725-A	4" Gooseneck Spout for Leg Tub Faucet	1	\$50.00
PF-731-G	3" Tailpiece for Bath Drain	1	\$9.50
731-K	Tailpiece Bent 90° for 1645-S & 1675-S	1	\$23.50
PF-741-DO	Spout Adapter for Bar Faucet	1	\$8.00
PF-752-T	2-1/2" Gooseneck Spout for Glass Filler	1	\$36.00
SU-756-CB	Post with Pin for Bath Drain	1	\$5.00
G-756-E	Regulator Stem With Washer for Restaurant Glass Filler (For 0323)	1	\$2.50
X765-TA	Brass Hex Packing Nut for Stem Assembly-6/pk	6	\$9.00
SU-767	Supply Tube for Bar Faucet	1	\$15.20
PF-768-D	Bubbler Cap for Drinking Fountain	1	\$8.00
PF-776-D	Bubbler Shank for Drinking Fountain	1	\$10.50
781-A	Shank	1	\$15.00
XPF-782-D	Brass Spout Nut RC-2/pk	2	\$6.00
XPF-784-C	Spout Hose End Adapter CP-2/pk	2	\$6.00
X809	Packing #52AFT Material-10/pk	10	\$2.50
X814-BARP	Rubber Packing-10/pk	10	\$10.00
X848-B	Felt Packing-10/pk	10	\$3.50
X901-WNN	Seat Washer-25/pk	25	\$3.50
X904-N	Buna Seat Washer for Self-Closing Stem Assembly -6/pk	6	\$1.65
X913-N	Acrylonitrile Seat Washer-10/pk	10	\$2.00
G-913-A	Coupling Nuts & Washers (2 Sets) (Thinner Crowfoot Washer)	1	\$6.55
G-914-SA	Coupling Nuts & Washers (2 Sets) (Thicker Crowfoot Washer)	1	\$7.00
X936-A	Rubber Washer for Stand Pipe-6/pk	6	\$4.50
X940	Rubber Washer for Bubbler Head-10/pk	10	\$3.00
X940-TRN	Santoprene Washer-10/pk	10	\$3.50
X944-N	Santoprene Washer-2/pk	2	\$1.50
X945	Rubber Seat Washer-2/pk	2	\$3.50
X947-C	Rubber Washer-10/pk	10	\$4.00
X954-AN	Slip Joint Rubber Washer-10/pk	10	\$2.00
X977	Packing-10/pk	10	\$4.50
990-L	Sponge Washer	1	\$5.00
X991	Rubber Washer for Centralift Lift & Turn Bath Drain-4/pk	4	\$3.00

Part #	Description	PCS/ CS	List Price
X991-A	Rubber Washer-4/pk	4	\$7.00
X991-C	Rubber Washer for Trip Lever Bath Drain-4/pk	4	\$3.50
1008-B	Stainless Steel Spring	1	\$2.50
X1009-A	Spring for Self-Closing Stem Assembly -2/pk	2	\$12.00
1011-N	Escutcheon	1	\$7.50
1012-N	Spout Escutcheon	1	\$9.00
X1028-Y	Nylon Gasket-25/pk	25	\$2.50
X1038-453	O-Ring for Stem Assembly-25/pk	25	\$4.00
X1038-IN	O-Ring for Shelf/Slant Back Lavatory Faucets Center Tee Use-10/pk	10	\$3.50
X1038-KN	O-Ring Epdm Rubber-25/pk	25	\$7.00
X1038-W	O-Ring Buna N-10/pk	10	\$4.00
G-1043	4-Arm Handle W/Screw-Plain	1	\$10.10
X1043-B	Brass Washer-6/pk	6	\$4.00
PF-1043-A	Push Button Cap for Glass Filler	1	\$3.50
G-1043-C	Cylinder Sub-Unit with Gasket	1	\$26.60
X1043-FN	Nylon Washer-2/pk	2	\$1.50
SU-1043-S	Push Valve Stem With Diaphragm for Glass Filler	1	\$9.00
X1043-T	Brass Washer for Stand Pipe-6/pk	6	\$2.50
X1081-N	Brass Hex Nut-10/pk	10	\$2.00
PF-1090-J	Regulator Cap for Glass Filler (For 0323)	1	\$3.50
SU-1109	Pop-Up Drain Less Pull Rod Ball Lever Rod & Bracket	1	\$38.50
XSU-1548-BSP	Stem Assembly For Wash Machine Filler & Shower Valve-2/pk	2	\$36.50
G-1548-ET	Stem Extension with Screw	1	\$33.00
X1549	Stem Bonnet for Wash Machine Filler & Single By-pass Shower Valve-2/pk	2	\$19.50
G-1588-CT	Stem & Diverter Bonnet Grp (K-3-DT)	1	\$16.50
U-1615-50RC	2-1/2" Rigid Spout w/Hose End & Vacuum Breaker For 0050 Service Sink	1	\$110.30
U-1615-54-02	Rigid Spout W/Hose End & Vacuum Breaker Include Adjuster Rod & Pin	1	\$186.50
U-1615-54-04	Rigid Spout W/Hose End & Vacuum Breaker Include Adjuster Rod & Pin	1	\$139.00
G-1748-88W	Swivel Spout Adapter	1	\$14.60
XG-1867-ALCP	Wheel Handle with X126-S Screw Chrome Plated-2/pk	2	\$17.50
X1875	1/2" IP Union Inlets for Rough Brass Faucet Only-2/pk	2	\$6.00
X1875-C	1/2" Copper Sweat Union Inlets for Rough Brass Faucet Only-2/pk	2	\$6.00
X1876-BB	Coupling Nut for Rough Brass Faucet Only-2/pk	2	\$9.00

\*Will be obsolete when present stock is depleted

Note: Order by Number of Packs Required, Not by Individual Pieces

## PARTS

Part #	Description	PCS/ CS	List Price
SU-2051-P	Pull Rod Guide for 1104 & 1104-BP Pop-Up Drain Only	1	\$13.80
2056-SPT1109	Top Flange for 1109 Pop-up	1	\$5.00
G-2090-S	Spout Shank Trim Group	1	\$28.00
SU-2090-A	4-1/2" Blendo Widespread Spout With Aerator	1	\$123.00
SU-2090-AB	4-1/2" Blendo Widespread Spout With Aerator No Pull Rod Hole	1	\$122.50
G-2115-TP	Stopper for U-1109	1	\$7.50
2126-A	Rocker Arm for 1177	1	\$6.00
X2133-210	Brass Flange for Leg Tub Faucet-2/pk	2	\$49.20
SU-2136-FA	Slant Back Spout With Aerator (For 1178)	1	\$74.00
U-2170-AL	Hot Corner Body Valve Unit for Shelf Back Lavatory Faucet	1	\$61.50
U-2170-AR	Cold Corner Body Valve Unit for Shelf Back Lavatory Faucet	1	\$61.50
U-2171-A	6" Center Tee w/ Rocker Arm for Shelf Back/Slant Back Lavatory Faucet	1	\$38.00
SU-2775-R-02	Double-Joint Swing Spout	1	\$42.00
SU-2806	Female Flange Adjustable 6-1/2" to 9-1/2"	1	\$51.00
SU-2807	Female Flange Adjustable 7-7/8" to 8-1/8"	1	\$34.60
SU-2841-ARC	Female Flange Adjustable 3" to 13" With Integral Stops	1	\$82.00
SU-2841-S	Female Flange Adjustable 2-1/2" to 8-1/2"	1	\$108.00
SU-2846	Male Flange Adjustable 7-7/8" to 8-1/8"	1	\$38.70
G-2887	Wall Bracket with Nipples & Wood Screws	1	\$104.00
2985-J	Cast Brass Centerpiece	1	\$29.70
SU-2923-A	5" Cast Spout With Aerator	1	\$69.50
SU-2924-A	6-1/8" Swivel Tube Spout With Aerator	1	\$26.50
SU-2924-H-02	6-1/8" Swivel Tube Spout With Hose End Chrome Plated	1	\$26.50
SU-2924-H-01	6-1/8" Swivel Tube Spout With Hose End Rough Brass	1	\$21.50
SU-2929-01	6-1/4" Swivel Cast Brass Spout W/Hose End For Laundry Rough Brass	1	\$36.00
SU-2987-DA	Guide for Hose & Spray	1	\$7.50
X3008-X	Brass Coupling Nut-2/pk	2	\$6.00
G-3009-A	Strainer Group	1	\$34.00
SU-3026-B	Drain Shoe & Tube	1	\$41.00
SU-3026-CDL	Drain Shoe & Tube Without Strainer Body	1	\$23.50
G-3036-A	Centralift Strainer Group	1	\$61.35
3034-1/2-02	Shower Head with Brass Shower Ball	1	\$17.90
3042-A	Plunger for 1655	1	\$25.00
3042-P	Plunger for 1555	1	\$8.00

\*Will be obsolete when present stock is depleted

Part #	Description	PCS/ CS	List Price
3061-AZ1/2	1/2" IPS & Slip-on Combo Diverter Tub Spout	1	\$25.00
G-3113-6	Shower Head, Arm (6") & Flanges	1	\$30.50
SU-3130-M	Wall Bracket Rod & Pin Group for Service Sink Faucet	1	\$61.00
G-3131	Wall Bracket Group	1	\$70.00
3145-D	Brass Overim Tub Spout, 1/2" I.P.S.	1	\$62.50
3154-Z	Zamak Overim Tub Spout, 1/2" I.P.S.	1	\$13.00
G-3359-A	Strainer Plug	1	\$14.50
PF-3359-A	Brass Drain Plug For Bath Drains	1	\$10.00
SU-3359-A	Strainer Plug assembly With Plug Guide & Rocker Arm for Bath Drain	1	\$31.50
3362	Strainer Plug Body	1	\$30.00
X4079-3/8	Brass Hex Locknut for Item 0425 Push Button Gravity Faucet Only-4/pk	1	\$11.50
G-4147-C	Wrist Handle (4") With Blue Index Ring & Screw-Cold	1	\$31.50
G-4147-H	Wrist Handle (4") With Red Index Ring & Screw-Hot	1	\$31.50
G-4149-C	Wrist Handle (6") With Blue Index Ring & Screw-Cold	1	\$34.00
G-4149-H	Wrist Handle (6") With Red Index Ring & Screw-Hot	1	\$34.00
PF-5075-YP	Nut for Stand Pipe	1	\$6.00
G-5355-S	Rod Adjuster & Pin Group	1	\$10.50
PF-6928-P	Self-Closing 4-Arm Handle	1	\$39.70
G-6928-V	Self-Closing 4-Arm Vandal Proof Handle With Set Screw	1	\$43.90
PF-6930	Hex Cap Nut for Glass Filler (For 0393)	1	\$18.90
SU-6965	Bubbler Body for 0364-L/0365-L/0366-L	1	\$68.00
SU-7071	Bubbler Body for 0366-HX8 & 0366-HX8WB	1	\$123.50
7074-L	Drain Plate Chrome Plated	1	\$18.50
SU-7101-AF	Self-Closing Stem Assembly	1	\$10.50
PF-7114-P	Self-Closing Lever Handle	1	\$41.10
PF-7114-PS	Self-Closing Lever Handle With Hole for Chain & Ring	1	\$45.30
G-7114-V	Self-Closing Lever Vandal Proof Handle With Screw	1	\$44.00
G-7116-V	Self-Closing Lever Vandal Proof Handle With Screw	1	\$43.50
PF-7125	Brass Cap for Self-Closing-Plain	1	\$9.60
PF-7125-C	Brass Cap for Self-Closing-Cold	1	\$9.60
PF-7125-H	Brass Cap for Self-Closing-Hot	1	\$9.60
X7133-AZ	Zinc Die Cast Locknut-10/pk	10	\$7.00
G-7233	Leg Mounting Group for Item 0468	1	\$35.00
G-7237	Leg Mounting Group for Item 0470	1	\$23.30
G-7237-477	Leg & Wall Bracket Group (For 0477)	1	\$34.50
7255-M	Loose Key	1	\$3.00

Note: Order by Number of Packs Required, Not by Individual Pieces

## PARTS

Part #	Description	PCS/ CS	List Price
CS-13001C	Cross Handle-Cold	1	\$20.50
CS-13001H	Cross Handle-Hot	1	\$20.50
CS-13001P	Cross Handle-Plain	1	\$20.50
CS-13002C	Push Handle for 3127-Cold	1	\$14.40
CS-13002H	Push Handle for 3127-Hot	1	\$14.40
CS-13003P	Push Handle for 0355, 0356, 0336, 3137-Plain	1	\$5.40
CS-13004C	Stem Assembly W/Centerpiece & Lever Vandal Proof Handle-Cold	1	\$113.30
CS-13004H	Stem Assembly W/Centerpiece & Lever Vandal Proof Handle-Hot	1	\$113.30
CS-14001C	Lever Handle-Cold	1	\$45.00
CS-14001H	Lever Handle-Hot	1	\$45.00
CS-14001P	Lever Handle-Plain	1	\$45.00
CS-14002C	Cross Handle-Cold	1	\$52.00
CS-14002H	Cross Handle-Hot	1	\$52.00
CS-14002P	Cross Handle-Plain	1	\$52.00
CS-15001	Lever Handle	1	\$15.50
CS-19001C	Lever Handle-Cold	1	\$31.00
CS-19001H	Lever Handle-Hot	1	\$31.00
CS-19002C	Lever Handle-Cold	1	\$28.90
CS-19002H	Lever Handle-Hot	1	\$28.90
CS-19003C	Cross Handle-Cold	1	\$36.40
CS-19003H	Cross Handle-Hot	1	\$36.40
CS-19004C	Cross Handle-Cold	1	\$33.50
CS-19004H	Cross Handle-Hot	1	\$33.50
CS-19005	Stem Assembly W/Centerpiece & Lever Handle W/Cap-Plain	1	\$54.50
CS-19006	Stem Assembly W/Centerpiece & 4-Arm Handle W/Cap-Plain	1	\$53.40
CS-22001	6-1/4" Tri-Arc Gooseneck Swivel Spout W/Aerator	1	\$68.00
CS-22002	4-3/32" Combo Rigid/Swivel Gooseneck Spout With Aerator	1	\$37.50
CS-23002	C' Style Spout W/Aerator W/Pop-Up Hole	1	\$90.50
CS-25001	4-1/8" Gooseneck Swivel Spout W/Aerator	1	\$32.50
CS-42001	Spout Escutcheon	1	\$33.50
CS-42002	Easy Install Adapter for Chicago Faucet to Central Brass	1	\$35.20
CS-42003	Easy Install Adapter for T & S Faucet to Central Brass	1	\$31.80
CS-42004	Easy Install Adapter for Fisher Faucet to Central Brass	1	\$39.80
CS-43001	Mechanical Mixing Valve	1	\$58.50
CS-43005	18" Long 1/4" X 1/2" Flex Hose Connector	1	\$9.50

Part #	Description	PCS/ CS	List Price
CS-43006	30" Long 3/8" X 1/2" Flex Hose Connector	1	\$9.50
CS-43007	Control Module Filter	1	\$3.00
CS-43008	Ball Lever Rod Group for Item Nos. 1177 & 1178	1	\$4.50
CS-43009	8" Center Tee w/ Rocker Arm for Shelf Back/Slant Back Lavatory Faucet	1	\$57.00
CS-44001	Valve Escutcheon	1	\$20.60
CS-44002	2-9/16" Cuttable Brass Nipple	1	\$4.00
CS-45002	Pull Out Spray Head and Hose Kit for 1130	1	\$40.50
CS-45003	Hose Guide and Mounting Kit for 1130	1	\$15.50
CS-46001	Strain Plate With Weep Holes	1	\$2.40
CS-47001	Check Valve	2	\$5.50
CS-48001	Drain Adapter 3/8" to 1-1/4"	1	\$19.00
CS-49003	Vandal Resistant 13/16"-27 Thread Male 0.5 GPM Spray Pattern Aerator	1	\$13.50
CS-49004	Vandal Resistant 55/64"-27 Thread Female 0.5 GPM Spray Pattern Aerator	1	\$12.50
CS-49005	Vandal Resistant 13/16"-27 Thread Male 1.0 GPM Aerator	1	\$9.00
CS-49007	Vandal Resistant 13/16"-27 Thread Male 1.5 GPM Aerator	1	\$8.00
CS-49008	Vandal Resistant 55/64"-27 Thread Female 1.5 GPM Aerator	1	\$6.50
CS-49009	13/16"-27 Thread Male 0.5 GPM Spray Pattern Aerator	1	\$10.50
CS-49011	13/16"-27 Thread Male 1.0 GPM Aerator	1	\$3.50
CS-49012	55/64"-27 Thread Female 1.0 GPM Aerator	1	\$4.00
CS-49013	13/16"-27 Thread Male 1.5 GPM Aerator	1	\$4.50
CS-49014	55/64"-27 Thread Female 1.5 GPM Aerator	1	\$3.50
CS-49015	13/16"-27 Male Thread Vandal Proof Laminar 1.5 GPM Aerator	1	\$6.50
CS-49018C	Handle Button-Cold	1	\$2.00
CS-49018H	Handle Button-Hot	1	\$2.00
CS-49019	Handle Screw	1	\$0.75
CS-49020	Teflon Gasket	1	\$2.00
CS-49026	POM Spring Support Packing	1	\$3.60
CS-49027	POM Spring Support Packing For 1167/ 0031/ 0033 Series	1	\$3.10
CS-53001	Mounting Kit for 2092	1	\$4.50
CS-53002	Mounting Kit for 2093, 2094	1	\$6.00
CS-53003	Mounting Tool for 2093, 2094	1	\$7.20
CS-53004	Mounting Kit for 2095	1	\$9.00
CS-63003	AC Power Adapter	1	\$36.00
CS-63004	Control Module	1	\$277.00
CS-63005	Brass Pop-up Drain Assembly	1	\$40.50

\*Will be obsolete when present stock is depleted

Note: Order by Number of Packs Required, Not by Individual Pieces

# PARTS

Part #	Description	PCS/ CS	List Price
XCS-44002	2-9/16" Cuttable Brass Nipple-10/pk	10	\$38.00
XCS-45004	Retaining Ring 2/Pk	2	\$5.00
XCS-45005	Retainer Nut 2/Pk	2	\$2.50
XCS-45006	Gasket 5/Pk	5	\$1.00
XCS-45007	O-Ring 5/Pk	5	\$1.00
XCS-49001	3/32" Allen Screw 10/Pk	10	\$1.00
XCS-49002	Red/Blue Indicator 10/Pk	10	\$2.00
XCS-53005	Mounting Screws for Control Module 4 Pairs	4	\$2.00
CS-49029	Full Flow Streamer (Female)	1	\$3.30
G-285-AZ	Brass Soap Dish	1	\$11.50
X1038-S	O-Ring-2/pk	2	\$1.20
X4015	Brass Coupling Nut-4/pk	1	\$5.50
XPF-460	Brass Cap Nut-2/pk	2	\$6.90

# TERMS & CONDITIONS

## PIONEER

### PAYMENT TERMS

Net 30 days for all accounts in good standing. 1-1/2% per month interest on all past due balances. Should any invoice be held in question, the balance not in question must be paid within the previously mentioned terms.

### ORDERS

Minimum orders \$100 net.

### BACKORDERS

Backorders will be shipped unless otherwise notified by customer.

### SALES TAX

All merchandise is sold to customers for resale. Customers assume full responsibility for all taxes or other assessments imposed by any government agency. All customers must furnish Pioneer a valid resale or tax exemption number.

### RETURNS

Product MAY NOT be returned without prior inspection and written authorization from a Pioneer Industries Inc. sales representative. An approved Returned Goods Authorization must accompany all returns. A handling charge of 50% will be assessed against any returned product without prior authorization. Credits will be issued based on the established purchase price less any applicable transportation, handling and restocking charges. Returns of discontinued products or products in non-resalable condition are not accepted and will be issued credit at scrap value only. Credits must be taken within six months of date of issue.

### CLAIMS

All claims for shortages must be made within 3 days of receipt of shipment. Pioneer shall be held blameless in any claim of injury during installation of Pioneer merchandise.

### PRICES

Prices are subject to change without notice.

### MODELS

Pioneer may, at its discretion, discontinue, modify or change any product listed in its catalog without prior notice.

### FREIGHT

All goods are sold F.O.B. Commerce, California or F.O.B. Antioch, Tennessee. Freight will be prepaid on orders of \$1000 net or more to all 48 contiguous states. Prepaid orders from customers not within 48 contiguous states will be shipped prepaid to any port or border destination within the 48 contiguous states. We reserve the right to ship via the most cost effective route.

### SALES POLICY

Possession of this catalog does not constitute an offer to sell.

### DISCLAIMER

Any and all references to trade names and/or trademarks in this catalog shall not be construed to be an endorsement by such manufacturer.

# TERMS & CONDITIONS

## OLYMPIA

### PAYMENT TERMS

Net 30 days for all accounts in good standing. 1-1/2% per month interest on all past due balances. Should any invoice be held in question, the balance not in question must be paid within the previously mentioned terms.

### ORDERS

Minimum orders \$100 net.

### BACKORDERS

Backorders will be shipped unless otherwise notified by customer.

### SALES TAX

All merchandise is sold to customers for resale. Customers assume full responsibility for all taxes or other assessments imposed by any government agency. All customers must furnish Olympia Faucets a valid resale or tax exemption number.

### RETURNS

Product MAY NOT be returned without prior inspection and written authorization from a Olympia Faucet, Inc. sales representative. An approved Returned Goods Authorization must accompany all returns. A handling charge of 50% will be assessed against any returned product without prior authorization. Credits will be issued based on the established purchase price less any applicable transportation, handling and restocking charges. Returns of discontinued products or products in non-resalable condition are not accepted and will be issued credit at scrap value only. Credits must be taken within six months of date of issue.

### CLAIMS

All claims for shortages must be made within 3 days of receipt of shipment. Olympia shall be held blameless in any claim of injury during installation of Olympia merchandise.

### PRICES

Prices are subject to change without notice.

### MODELS

Olympia may, at its discretion, discontinue, modify or change any product listed in its catalog without prior notice.

### FREIGHT

All goods are sold F.O.B. Commerce, California or F.O.B. Antioch, Tennessee. Freight will be prepaid on orders of \$1000 net or more to all 48 contiguous states. Prepaid orders from customers not within 48 contiguous states will be shipped prepaid to any port or border destination within the 48 contiguous states. We reserve the right to ship via the most cost effective route.

### SALES POLICY

Possession of this catalog does not constitute an offer to sell.

### DISCLAIMER

Any and all references to trade names and/or trademarks in this catalog shall not be construed to be an endorsement by such manufacturer.

# TERMS & CONDITIONS

## CENTRAL BRASS

This price book has been prepared for the convenience of Central Brass' distributors and their customers and supersedes all previous Central Brass price schedules. The prices shown are the basis for distributor discounts and are not intended as resale prices. Possession of this price book by any person is not an offer to sell them, or anyone else, the goods listed herein at the prices shown.

### SALES TAX

All merchandise is sold to customers for resale. Customers assume full responsibility for all taxes or other assessments imposed by any government agency. All customers must furnish a valid resale or tax exemption number.

### RETURNED GOODS

Product MAY NOT be returned without prior inspection and written authorization from a Central Brass representative. An approved Returned Goods Authorization must accompany all returns. A handling charge of 50% will be assessed against any returned product without prior authorization. Credits will be issued based on the established purchase price less any applicable transportation, handling and restocking charges. Returns of discontinued products or products determined to be in non-resalable condition are not accepted and will be issued credit at scrap value only. Credits must be taken within six months of date of issue.

### CLAIMS

Claims for shortage of goods must be presented within 5 days from the date of receipt of shipment and must state the packing slip number applicable to the claim. Any claim not so presented will be conclusively deemed waived.

### WARRANTY

Central Brass products are warranted to the original consumer purchaser. Please refer to the warranty enclosed with each Central Brass product for specific details. Additional copies are available upon request.

### SALES POLICY

All prices within this catalog are subject to change without notice. Goods which differ in any material respect, such as size or finish, from the goods as illustrated and described in Seller's literature are subject to special prices. Central Brass may, at its discretion, discontinue, modify or change any product listed in its catalog without prior notice.



STYLE

THAT

WORKS

## **PIONEER INDUSTRIES**

3325 S. Garfield Avenue  
Commerce, CA 90040

Email: [sales@pioneerind.com](mailto:sales@pioneerind.com)

Phone: 800.338.9468

Fax: 323.888.9515

[pioneerind.com](http://pioneerind.com)

[olympiafaucets.com](http://olympiafaucets.com)

[centralbrass.com](http://centralbrass.com)

