

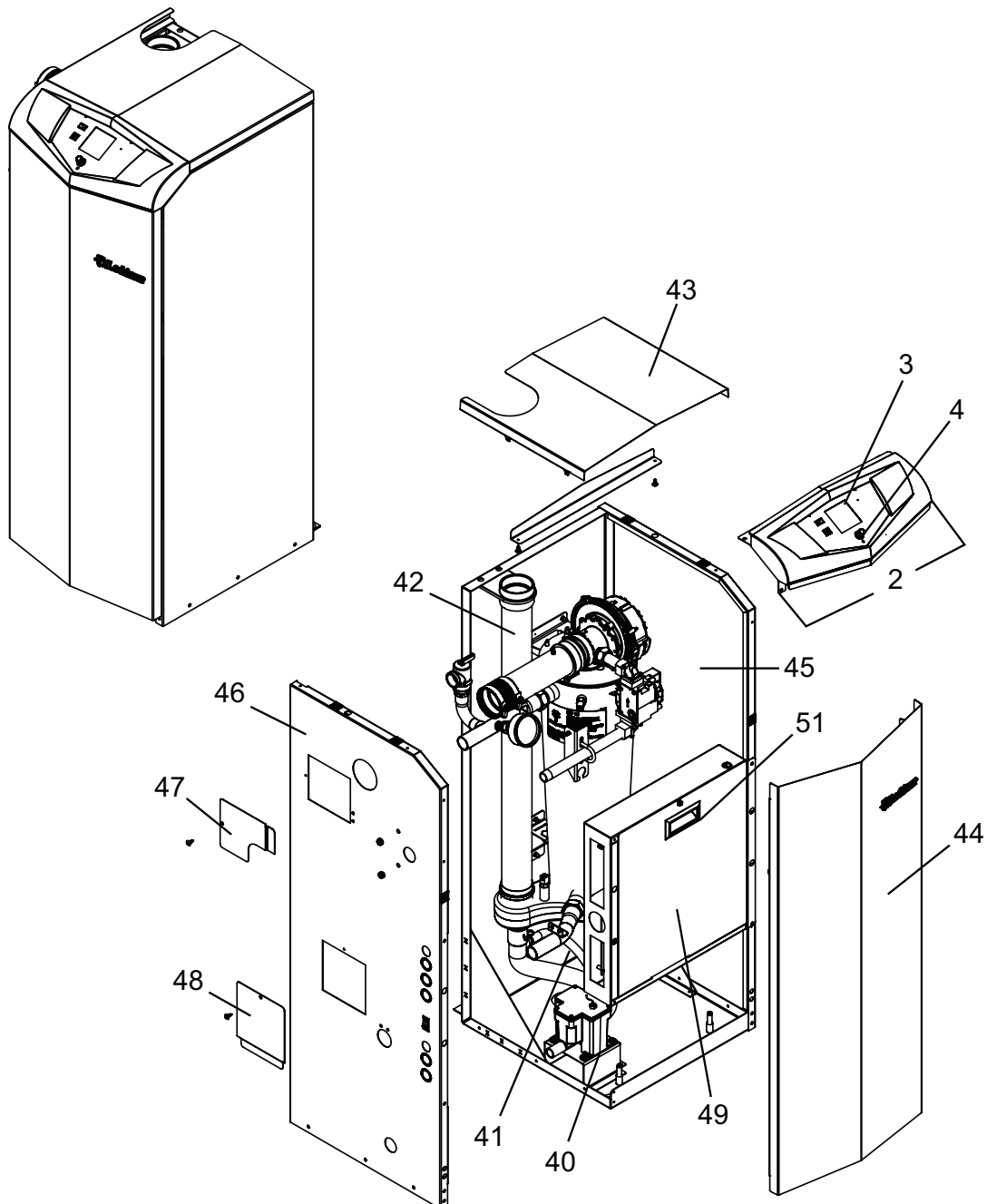

Replacement Parts List

PARTS & SERVICE DEPARTMENT
 Nashville, Tennessee
 877-554-5544 • Fax: 615-882-2918
 parts_team@lochinvar.com
 www.Lochinvar.com

Knight Fire Tube Boilers KH 55 thru 285



2000507833 00

GAS TRAIN

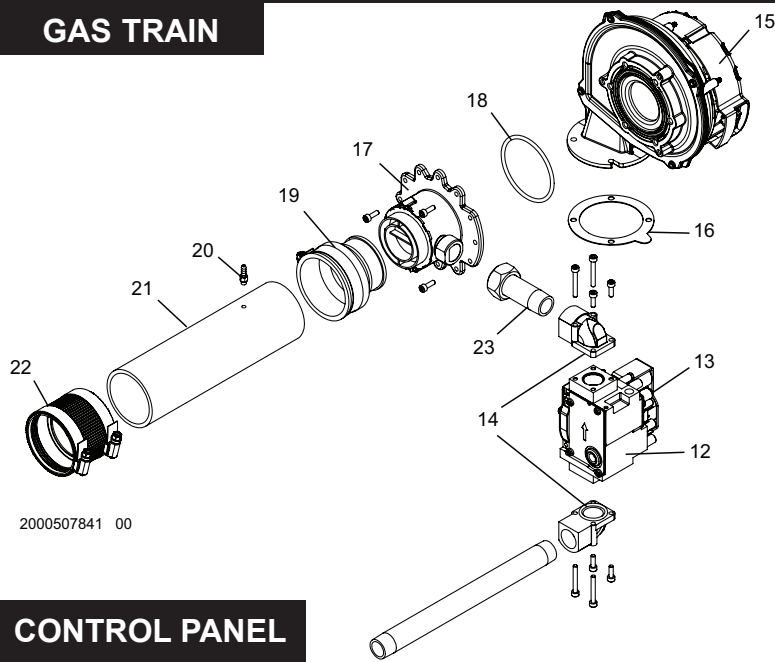

2000507841 00

HEAT EXCHANGER

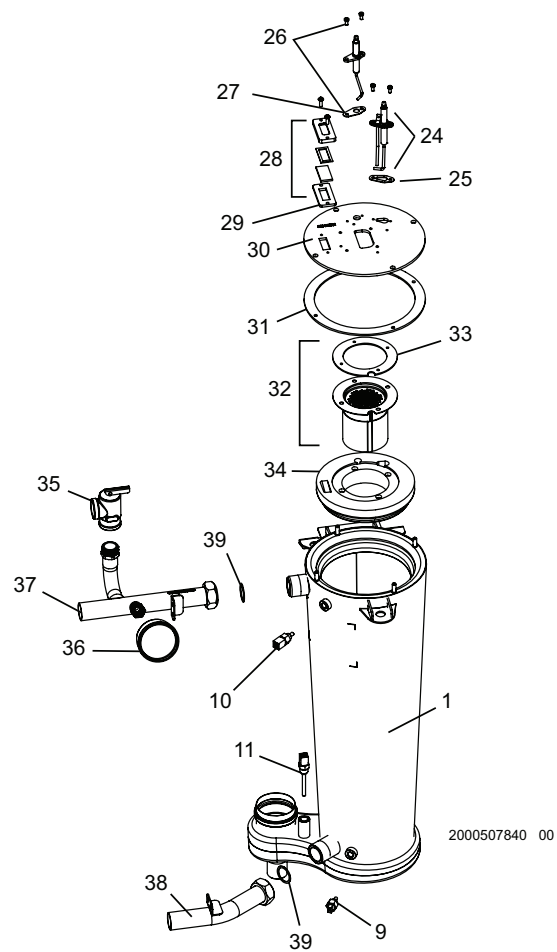

2000507840 00

CONTROL PANEL

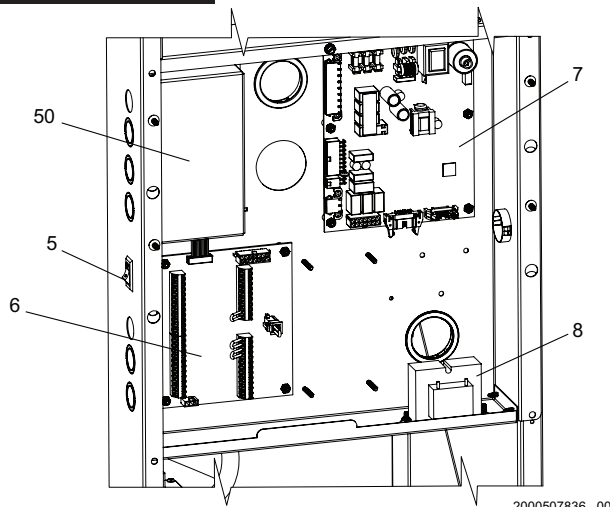

2000507836 00

ITEM NO.	PART NO.	DESCRIPTION	MODEL
HEAT EXCHANGER ASSEMBLY			
1	100266940	HEAT EXCHANGER - ASME - H STAMP - 55 MBH	KH 055
1	100266951	HEAT EXCHANGER - ASME - H STAMP - 85 MBH	KH 085
1	100266953	HEAT EXCHANGER - ASME - H STAMP - 110 MBH	KH 110
1	100266958	HEAT EXCHANGER - ASME - H STAMP - 155 MBH	KH 155
1	100266959	HEAT EXCHANGER - ASME - H STAMP - 199 MBH	KH 199
1	100266971	HEAT EXCHANGER - ASME - H STAMP - 285 MBH	KH 285
CONTROLS			
2	100267999	DISPLAY BEZEL ASSEMBLY	ALL
3	100278134*	USER INTERFACE CONTROL	ALL
4	100277824	FLUTED KNOB W/ SKIRT	ALL
5	100208242	ON / OFF SWITCH,W/ I-O SYMBOL	ALL
6	100277940*	CONNECTION BOARD	ALL
7	100286874*	MAIN CONTROL BOARD	KH 055
7	100286875*	MAIN CONTROL BOARD	KH 085
7	100266978*	MAIN CONTROL BOARD (PRIOR TO SERIAL #1738)	KH 110
7	100286877*	MAIN CONTROL BOARD (BEGINNING SERIAL #1738)	KH 110
7	100266979*	MAIN CONTROL BOARD (PRIOR TO SERIAL #1738)	KH 155
7	100286880*	MAIN CONTROL BOARD (BEGINNING SERIAL #1738)	KH 155
7	100266980*	MAIN CONTROL BOARD (PRIOR TO SERIAL #1738)	KH 199
7	100286923*	MAIN CONTROL BOARD (BEGINNING SERIAL #1738)	KH 199
7	100266982*	MAIN CONTROL BOARD (PRIOR TO SERIAL #1738)	KH 285
7	100287207*	MAIN CONTROL BOARD (BEGINNING SERIAL #1738)	KH 285
7	100287202*	MAIN CONTROL BOARD, HIGH ALTITUDE	KH 055
7	100287201*	MAIN CONTROL BOARD, HIGH ALTITUDE	KH 085
7	100266994*	MAIN CONTROL BOARD, HIGH ALTITUDE (PRIOR TO SERIAL #1738)	KH 110
PLEASE HAVE MODEL AND SERIAL NUMBER WHEN ORDERING PARTS			
*ITEMS DENOTE SUGGESTED INVENTORY PARTS			

ITEM NO.	PART NO.	DESCRIPTION	MODEL
CONTROLS (CONTINUED)			
7	100287188*	MAIN CONTROL BOARD, HIGH ALTITUDE (BEGINNING SERIAL #1738)	KH 110
7	100266995*	MAIN CONTROL BOARD, HIGH ALTITUDE (PRIOR TO SERIAL #1738)	KH 155
7	100287187*	MAIN CONTROL BOARD, HIGH ALTITUDE (BEGINNING SERIAL #1738)	KH 155
7	100266996*	MAIN CONTROL BOARD, HIGH ALTITUDE (PRIOR TO SERIAL #1738)	KH 199
7	100287185*	MAIN CONTROL BOARD, HIGH ALTITUDE (BEGINNING SERIAL #1738)	KH 199
7	100266997*	MAIN CONTROL BOARD, HIGH ALTITUDE (PRIOR TO SERIAL #1738)	KH 285
7	100287182*	MAIN CONTROL BOARD, HIGH ALTITUDE (BEGINNING SERIAL #1738)	KH 285
8	100208230	TRANSFORMER	ALL
9	100208560*	INLET SENSOR	ALL
10	100208547*	OUTLET SENSOR	ALL
11	100287156*	FLUE TEMPERATURE SENSOR W/ GROMMET	ALL
-	100208321*	FLUE SENSOR GROMMET	ALL
GAS TRAIN			
12	100268028*	GAS VALVE ASSEMBLY W/ FLANGE & SCREWS	KH 055
12	100268029*	GAS VALVE ASSEMBLY W/ FLANGE & SCREWS	KH 085
12	100268030*	GAS VALVE ASSEMBLY W/ FLANGE & SCREWS	KH 110
12	100268031*	GAS VALVE ASSEMBLY W/ FLANGE & SCREWS	KH 155
12	100268032*	GAS VALVE ASSEMBLY W/ FLANGE & SCREWS	KH 199
12	100268033*	GAS VALVE ASSEMBLY W/ FLANGE & SCREWS	KH 285
13	100275533	GAS VALVE ON / OFF SWITCH	ALL
14	100275534	GAS VALVE FLANGE WITH GASKET	ALL
15	100266999*	FAN ASSEMBLY	KH 055-155
15	100267000*	FAN ASSEMBLY (PRIOR TO SERIAL #1738)	KH 199-285
15	100318771*	FAN ASSEMBLY (BEGINNING SERIAL #1738)	KH 199-285
16	100208101*	FAN GASKET	ALL
17	100287149	VENTURI W/ GASKETS - NATURAL	KH 055-085
17	100277835	VENTURI W/ GASKETS - NATURAL (PRIOR TO SERIAL #1738)	KH 110 & 199
17	100287147	VENTURI W/ GASKETS - NATURAL (BEGINNING SERIAL #1738)	KH 110
17	100277744	VENTURI W/ GASKETS - NATURAL (PRIOR TO SERIAL #1738)	KH 155
17	100287145	VENTURI W/ GASKETS - NATURAL (BEGINNING SERIAL #1738)	KH 155
17	100287143	VENTURI W/ GASKETS - NATURAL (BEGINNING SERIAL #1738)	KH 199
17	100287142	VENTURI W/ GASKETS - NATURAL	KH 285
17	100287130	VENTURI W/ GASKETS - LP	KH 055
17	100287129	VENTURI W/ GASKETS - LP	KH 085
17	100277823	VENTURI W/ GASKETS - LP (PRIOR TO SERIAL #1738)	KH 110
17	100287127	VENTURI W/ GASKETS - LP (BEGINNING SERIAL #1738)	KH 110
17	100268107	VENTURI W/ GASKETS - LP (PRIOR TO SERIAL #1738)	KH 155
17	100287126	VENTURI W/ GASKETS - LP (BEGINNING SERIAL #1738)	KH 155
17	100268108	VENTURI W/ GASKETS - LP (PRIOR TO SERIAL #1738)	KH 199
17	100287124	VENTURI W/ GASKETS - LP (BEGINNING SERIAL #1738)	KH 199
17	100287123	VENTURI W/ GASKETS - LP	KH 285
18	100277743*	VENTURI GASKET	KH 055-155
18	100208761*	VENTURI GASKET	KH 199-285
19	100288556	VENTURI COUPLING	KH 055-199
19	100288581	2" X 1-1/2" COUPLING WITH CLAMPS AND GASKET	KH 285
20	100208326	BRASS BARB	ALL
21	100290058	2" X 8" PVC AIR INLET CONNECTION	ALL
22	100275561	3" AIR INLET COUPLING	KH 110-285
23	100275537	GAS VALVE UNION ADAPTER WITH GASKET	ALL
PILOT & BURNER ASSEMBLIES			
24	100165925*	SPARK IGNITOR W/ GASKET	ALL
25	100208086	SPARK IGNITOR GASKET	ALL
26	100165930*	FLAME SENSOR W/ GASKET & SCREWS	ALL
27	100208091	FLAME SENSOR GASKET	ALL
28	100189215	SIGHT GLASS KIT	ALL
29	100275566	RED SIGHT GLASS GASKET	ALL
30	100268111	HEAT EXCHANGER TOP PLATE ASSEMBLY	KH 055-085
30	100268112	HEAT EXCHANGER TOP PLATE ASSEMBLY	KH 110-155
30	100268113	HEAT EXCHANGER TOP PLATE ASSEMBLY	KH 199-285
31	100287111*	HEAT EXCHANGER TOP PLATE GASKET	KH 055-085
31	100287096*	HEAT EXCHANGER TOP PLATE GASKET	KH 110-155
31	100287094*	HEAT EXCHANGER TOP PLATE GASKET	KH 199-285
PLEASE HAVE MODEL AND SERIAL NUMBER WHEN ORDERING PARTS			
*ITEMS DENOTE SUGGESTED INVENTORY PARTS			

ITEM NO.	PART NO.	DESCRIPTION	MODEL
PILOT & BURNER ASSEMBLIES (CONTINUED)			
31	100287094*	HEAT EXCHANGER TOP PLATE GASKET	KH 199-285
32	100267965	MAIN BURNER ASSEMBLY	KH 055-085
32	100267967	MAIN BURNER ASSEMBLY	KH 110-155
32	100267968	MAIN BURNER ASSEMBLY	KH 199-285
33	100287092*	BURNER GASKET	KH 055-085
33	100287091*	BURNER GASKET	KH 110-155
33	100287090*	BURNER GASKET	KH 199-285
34	100287088	BURNER TOP PLATE INSULATION	KH 055-085
34	100287087	BURNER TOP PLATE INSULATION	KH 110-155
34	100287086	BURNER TOP PLATE INSULATION	KH 199-285
MISCELLANEOUS			
35	100284289	PRESSURE RELIEF VALVE	ALL
36	100208152	TEMPERATURE AND PRESSURE GAUGE	ALL
37	100290112	1" COPPER WATER OUTLET TUBE	KH 055-085
37	100278116	1" COPPER WATER OUTLET TUBE	KH 110-155
37	100290113	1-1/4" COPPER WATER OUTLET TUBE	KH 199-285
38	100290110	1" COPPER WATER INLET TUBE	KH 055-085
38	100290111	1" COPPER WATER INLET TUBE	KH 110-155
38	100278040	1-1/4" COPPER WATER INLET TUBE	KH 199-285
39	100287071	COPPER TUBE GASKET	KH 055-155
39	100278051	COPPER TUBE GASKET	KH 199-285
40	100284709	CONDENSATE TRAP	ALL
41	100290104	CONDENSATE TRAP HOSE ASSEMBLY	KH 055-085
41	100290105	CONDENSATE TRAP HOSE ASSEMBLY	KH 110-285
42	100289711	2" CPVC FLUE PIPE	KH 055-085
42	100289713	3" CPVC FLUE PIPE	KH 110-285
-	100208808*	TIME DELAY A V CLASS T FUSE, TIME DELAY, 1.25A, 250V	ALL
-	100208231*	TIME DELAY A V CLASS T FUSE, TIME DELAY, 3.15A, 250V	ALL
-	100290102*	TIME DELAY A V CLASS T FUSE, TIME DELAY, 6.3A, 250V	ALL
-	100163203	2" STAINLESS STEEL WIRE MESH BIRD SCREEN	KH 055-085
-	100163204	3" STAINLESS STEEL WIRE MESH BIRD SCREEN	KH 110-285
-	100208569	1/4" BULB WELL	ALL
-	100208552	THERMOSTAT SENSOR	ALL
-	100208834*	OUTDOOR AIR SENSOR	ALL
-	100286981	CONNECTION BOARD HARNESS	ALL
-	100278061	FLAME SENSOR HARNESS	ALL
-	100208620	SPARK IGNITOR HARNESS	ALL
-	100288514	POWER HARNESS	ALL
-	100288515	UNIT HARNESS	ALL
-	100208636	RIBBON CABLE	ALL
-	100208653*	FLOW SWITCH W/ PADDLE	ALL
-	100208652*	LOW WATER CUT-OFF W/ MANUAL RESET	ALL
-	100157719	ALARM BELL	ALL
-	100267566	INSTALL KIT	KH 055-085
-	100209658	INSTALL KIT	KH 110-155
-	100209659	INSTALL KIT	KH 199-285
-	100157775*	SYSTEM SENSOR KIT W/ BULB WELL & SLEEVE	ALL
-	100157718	SYSTEM SENSOR W/ BULB WELL & THERMOSTAT	ALL
-	100268040	LP CONVERSION KIT	KH 055
-	100268104	LP CONVERSION KIT	KH 085
-	100268105	LP CONVERSION KIT (PRIOR TO SERIAL #1738)	KH 110
-	100285815	LP CONVERSION KIT (BEGINNING SERIAL #1738)	KH 110
-	100268107	LP CONVERSION KIT (PRIOR TO SERIAL #1738)	KH 155
-	100285817	LP CONVERSION KIT (BEGINNING SERIAL #1738)	KH 155
-	100268108	LP CONVERSION KIT (PRIOR TO SERIAL #1738)	KH 199
-	100285818	LP CONVERSION KIT (BEGINNING SERIAL #1738)	KH 199
-	100268109	LP CONVERSION KIT	KH 285
-	100157609	SIDEWALL VENT KIT	KH 055-085
-	100157610	SIDEWALL VENT KIT	KH 110-155
-	100157611	SIDEWALL VENT KIT	KH 199-285
PLEASE HAVE MODEL AND SERIAL NUMBER WHEN ORDERING PARTS			
*ITEMS DENOTE SUGGESTED INVENTORY PARTS			

ITEM NO.	PART NO.	DESCRIPTION	MODEL
MISCELLANEOUS (CONTINUED)			
-	100287029	2" CPVC TEE W/ ANALYZER PORT	KH 055-085
-	100287027	3" CPVC TEE W/ ANALYZER PORT	KH 110-285
PUMPS			
-	100277713*	PUMP ASSEMBLY - 3 SPEED, 1/25 HP, 1" FLANGE, CAST	KH 055-155
-	100277714*	PUMP ASSEMBLY -1/6 HP, 1-1/4" FLANGE, CAST	KH 199-285
JACKET ASSEMBLY			
43	100268026	OUTER TOP JACKET ASSEMBLY	ALL
44	100268021	OUTER FRONT JACKET ASSEMBLY	ALL
45	100268025	OUTER RIGHT JACKET ASSEMBLY	ALL
46	100268022	OUTER LEFT JACKET ASSEMBLY	KH 055-085
46	100268023	OUTER LEFT JACKET ASSEMBLY	KH 110-155
46	100268024	OUTER LEFT JACKET ASSEMBLY	KH 199-285
47	100290078	WATER OUTLET COVER PANEL	ALL
48	100290074	FLUE SENSOR COVER PANEL	ALL
49	100290073	CONTROL PANEL COVER	ALL
50	100290077	JUNCTION BOX COVER	ALL
51	100288542	3" DOOR HANDLE	ALL
-	100232751*	BLUE DOOR CATCH	ALL
-	100208818*	DOOR STRIKE	ALL

PLEASE HAVE MODEL AND SERIAL NUMBER WHEN ORDERING PARTS
*ITEMS DENOTE SUGGESTED INVENTORY PARTS

NOTES

NOTES

