



# I-100

## FIELD INSTALLATION HANDBOOK

24-inch/DN600 and Smaller Victaulic® Mechanical Piping Products for Carbon Steel, Stainless Steel, Aluminum, and CPVC/PVC Pipe



Revision H 03/2023

### WARNING



- Read and understand all instructions before attempting to install any Victaulic products.
- Always verify that the piping system has been completely depressurized and drained immediately prior to installation, removal, adjustment, or maintenance of any Victaulic products.
- Confirm that any equipment, branch lines, or sections of piping that may have been isolated for/during testing or due to valve closures/positioning are identified, depressurized, and drained immediately prior to installation, removal, adjustment, or maintenance of any Victaulic products.
- Wear safety glasses, hardhat, foot protection, and hearing protection.

Failure to follow these instructions could result in death or serious personal injury and property damage.

Contact Victaulic with any questions regarding safe and proper installation of products featured in this handbook.  
Visit [victaulic.com](http://victaulic.com) for the most up-to-date information on Victaulic products.

# Table of Contents

## NOTICE

- Pages that include information pertaining to FireLock™ branded products have been identified with a black band on the side of the page.

<b>INTRODUCTION .....</b>	<b>VII</b>
California Customers – Proposition 65 Compliance .....	viii
Canadian Customers – CSA B51 Compliance.....	viii
Hazard Identification .....	viii
<b>PIPE PREPARATION AND GROOVING SPECIFICATIONS .....</b>	<b>1</b>
Pipe Preparation.....	2
Tool Ratings .....	2
Pipe Lengths Suitable for Grooving .....	3
Explanation of Critical Roll Groove and Cut Groove Specifications - Original Groove System (OGS) and EndSeal™ .....	4
OGS Roll Groove Specifications for Carbon Steel Pipe and All Materials Grooved with Standard and RX Rolls .....	6
EndSeal™ “ES” Roll Groove Specifications for Standard-Wall or Plastic-Coated Pipe Joined with Style HP-70ES EndSeal™ Couplings .....	11
OGS Cut Groove Specifications for Steel and Other NPS Pipe .....	12
EndSeal™ “ES” Cut Groove Specifications for Standard-Wall or Plastic-Coated Pipe Joined with Style HP-70ES EndSeal™ Couplings .....	17
Explanation of Critical Roll Groove and Cut Groove Specifications - FireLock™ Innovative Groove System (IGS™).....	18
IGS™ Roll Groove Specifications for Schedules 10 and 40 NPS Carbon Steel Pipe .....	20
IGS™ Cut Groove Specifications for Schedules 10 and 40 NPS Carbon Steel Pipe .....	21
Explanation of Critical Standard Radius Cut Groove Specifications for Schedule 40 or 80 CPVC and PVC Pipe .....	22
Standard Radius Cut Groove Specifications for Schedule 40 or 80 CPVC and PVC Pipe.....	24
Pipe End Inspection and Preparation - Advanced Groove System (AGS™) Direct-Grooving Applications .....	26
Pipe End Inspection and Preparation - AGS™ <i>Vic-Ring</i> Applications.....	27
Explanation of Critical AGS Roll Groove Specifications.....	28
AGS Roll Groove Specifications for Carbon Steel and Stainless Steel Pipe (In Accordance with EN 10217, ASTM A-53, ASTM A-312, or API 5L) .....	30

<b>IMPORTANT GASKET AND LUBRICANT INFORMATION.....</b>	<b>31</b>
Gasket Selection and Lubricant Requirements .....	32
Gasket Color Code Reference .....	32
Lubrication of Gaskets .....	33
Storage of Gaskets.....	33
Lubricant Compatibility for Gaskets Table.....	34
Victaulic Lubricant Usage Guide .....	35
Dry Pipe Fire Protection System Notes .....	36
“NOTICE” for Victaulic FireLock™ Products with Pre-Lubricated Gaskets.....	36
<b>SPACING REQUIREMENTS FOR GROOVED PIPING SYSTEMS....</b>	<b>37</b>
Recommended Minimum Pipe Spacing .....	38
<b>RIGID SYSTEMS.....</b>	<b>39</b>
Piping Support for Rigid Systems.....	40
Rigid Systems - Pipe Support Spacing for Standard-Weight Carbon Steel Pipe .....	40
Rigid Systems - Pipe Support Spacing for Light-Wall Stainless Steel Pipe.....	42
Nominal Pipe-End Separation for OGS Rigid, Installation-Ready™ Couplings .....	44
Nominal Pipe-End Separation for All Other OGS Rigid Couplings.....	45
Nominal Pipe-End Separation for AGS Rigid Couplings on Direct-Grooved Pipe or Pipe Prepared with AGS <i>Vic-Rings</i> .....	46
<b>FLEXIBLE SYSTEMS.....</b>	<b>47</b>
Piping Support for Flexible Systems .....	48
Flexible Systems - Pipe Support Spacing .....	48
Nominal Range of Pipe-End Separation for Style 004N, 177N, and 877N Installation-Ready™ Flexible Couplings .....	50
Linear Movement and Angular Deflection for Style 004N, 177N, and 877N Installation-Ready™ Flexible Couplings .....	51
Nominal Pipe-End Separation and Deflection from Centerline for All Other OGS Flexible Couplings .....	52
Nominal Pipe-End Separation and Deflection from Centerline for AGS Flexible Couplings on Direct-Grooved Pipe .....	54
Nominal Pipe-End Separation and Deflection from Centerline for AGS Flexible Couplings on Pipe Prepared with AGS <i>Vic-Rings</i> .....	55
Installation to Achieve Maximum Linear Movement Capabilities of Flexible Systems.....	56
<b>INSTALLATION OVERVIEW.....</b>	<b>57</b>
Impact Tool Usage Guidelines.....	58
Impact Tool Selection .....	60
Torque Wrench Selection.....	60
Required Tools and Supplies for Installation .....	61
Important Installation Information .....	62
Installation Inspection.....	63
System Testing .....	65
Maintenance After Installation.....	65



Insulation .....	65
Buried Applications .....	66
European ATEX Directive .....	66
<b>ONE-BOLT INSTALLATION-READY™ COUPLINGS FOR GROOVED-END MATING COMPONENTS.....</b>	<b>67</b>
Preparatory Steps for Installation of Couplings Featured in this Section.....	68
Style 108 FireLock™ IGS™ Installation-Ready™ Rigid Coupling .....	70
Style 109 FireLock™ Installation-Ready™ Rigid Coupling .....	70
Style 118 FireLock™ IGS™ Installation-Ready™ Outlet Coupling.....	75
Instructions for Reassembly of Style 108 and 109 Couplings .....	79
Instructions for Reassembly of Style 118 Outlet Couplings .....	81
<b>INSTALLATION-READY™ COUPLINGS FOR GROOVED-END MATING COMPONENTS.....</b>	<b>83</b>
Preparatory Steps for Installation of Couplings Featured in this Section.....	84
Style 004N FireLock™ Installation-Ready™ Flexible Coupling .....	86
Style 009N FireLock EZ™ Installation-Ready™ Rigid Coupling .....	90
Style 107V QuickVic™ Installation-Ready™ Rigid Coupling .....	95
Style 107N QuickVic™ Installation-Ready™ Rigid Coupling.....	99
Style 807N QuickVic™ Installation-Ready™ Rigid Coupling for Potable Water .....	99
Style 115 FireLock EZ™ Installation-Ready™ Reducing Coupling.....	104
Style 171 Composite Flexible Coupling.....	109
Style 177N QuickVic™ Installation-Ready™ Flexible Coupling .....	112
Style 877N QuickVic™ Installation-Ready™ Flexible Coupling for Potable Water .....	112
Instructions for Reassembly of Style 009N, 107V, 107N, and 807N Couplings.....	116
Instructions for Reassembly of Style 115 Couplings.....	118
Instructions for Reassembly of Style 171 Couplings.....	120
Instructions for Reassembly of Style 004N, 177N, and 877N Couplings .....	122
<b>FIRELOCK™ INSTALLATION-READY™ FITTINGS FOR GROOVED-END MATING COMPONENTS.....</b>	<b>125</b>
Preparatory Steps for Installation of Fittings Featured in this Section.....	126
No. 101 (90° Elbow) and No. 103 (45° Elbow) FireLock™ Installation-Ready™ Fittings .....	128
Removal of a No. 101 or 103 Fitting from the Piping System.....	133

Reassembly of a No. 101 or 103 Fitting that was Fully Disassembled During Removal from the Piping System ....	134
No. 102 (Straight Tee) and No. 104 (Bullhead Tee) FireLock™ Installation-Ready™ Fittings .....	135
Removal of a No. 102 or 104 Fitting from the Piping System.....	145
Reassembly of a No. 102 or 104 Fitting that was Fully Disassembled During Removal from the Piping System .....	146
<b>STANDARD COUPLINGS FOR OGS GROOVED-END MATING COMPONENTS .....</b>	<b>147</b>
Preparatory Steps for Installation of Couplings Featured in this Section.....	148
Style 005H FireLock™ Rigid Coupling.....	150
Style 07 Zero-Flex™ Rigid Coupling (12-inch/DN300 and Smaller Sizes) .....	150
Style L07 Zero-Flex™ Rigid Coupling (12-inch/DN300 and Smaller Sizes) .....	150
Style 489 Stainless Steel Rigid Coupling (4-inch/DN100 and Smaller Sizes) .....	150
Style HP-70 Rigid Coupling (12-inch/DN300 and Smaller Sizes) .....	156
Style 89 Rigid Coupling .....	156
Style 889 Rigid Coupling for Potable Water Applications .....	156
Style 489 Rigid Stainless Steel Coupling (5-inch, DN125, and Larger Sizes).....	156
Style 489DX Duplex Stainless Steel Rigid Coupling .....	156
Style HP-70 Rigid Coupling (14-inch/DN350 and Larger Sizes).....	161
Style 77 Flexible Coupling (14-inch/DN350 and Larger Sizes - Four or Six Housings).....	161
Style 77S Stainless Steel Flexible Coupling (16-inch/DN400 and Larger Sizes - Four Housings) .....	161
Style 72 Outlet Coupling .....	165
Style 75 Flexible Coupling.....	169
Style 77 Flexible Coupling (24-inch/DN600 and Smaller Sizes - Two Housings).....	169
Style L77 Flexible Coupling (12-inch/DN300 and Smaller Sizes) .....	169
Style 77A Aluminum Flexible Coupling.....	169
Style 77S Stainless Steel Flexible Coupling (8 – 14-inch/DN200 – DN350 Sizes) .....	169
Style 77DX Duplex Stainless Steel Flexible Coupling.....	169
Style 475 Lightweight Stainless Steel Flexible Coupling .....	169
Style 475DX Duplex Stainless Steel Flexible Coupling.....	169
Style 78 Snap-Joint™ Coupling.....	175
Style 78A Snap-Joint™ Aluminum Coupling .....	175
Style 750 Reducing Coupling.....	178
Style 875 Reducing Coupling for Potable Water Applications.....	178
Style 707-IJ NPS-to-JIS Transition Coupling .....	182
Instructions for Reassembly of Couplings Featured in this Section.....	186

**STANDARD COUPLING FOR ENDSEAL™ GROOVED-END MATING COMPONENTS..... 187**

- Style HP-70ES EndSeal™ Rigid Coupling ..... 188
- Instructions for Reassembly..... 192

**ADVANCED GROOVE SYSTEM (AGS) COUPLINGS FOR AGS DIRECT-GROOVED PIPE OR AGS VIC-RING APPLICATIONS ..... 193**

- Style W07 AGS Rigid Coupling (24-inch/DN600 and Smaller Sizes) ..... 194
- Style LW07 AGS Rigid Coupling (14 – 16-inch/ DN350 – DN400 Sizes) ..... 194
- Style W77 AGS Flexible Coupling (24-inch/DN600 and Smaller Sizes) ..... 194
- Style W89 AGS Rigid Coupling for Direct-Grooved Stainless Steel Pipe or Carbon Steel Pipe Prepared with AGS *Vic-Rings* (24-inch/DN600 and Smaller Sizes)..... 194
- Instructions for Reassembly of Couplings Featured in this Section..... 198

**FLANGE ADAPTERS FOR OGS GROOVED-END PIPE..... 199**

- Style 441 Stainless Steel *Vic-Flange* Adapter Notes..... 200
- Style 441 Stainless Steel *Vic-Flange* Adapter..... 202
- Victaulic Flange Adapter Notes for 12-inch/DN300 and Smaller Sizes (Style 741, 841, 743, and 744)..... 206
- Victaulic Flange Washer Notes for 12-inch/DN300 and Smaller Sizes (Style 741, 841, 743, and 744)..... 207
- Style 741 *Vic-Flange* Adapter (12-inch/DN300 and Smaller Sizes) ..... 208
- Style 841 *Vic-Flange* Adapter for Potable Water ..... 208
- Style 743 *Vic-Flange* Adapter..... 208
- Style 744 FireLock™ Flange Adapter..... 208
- Victaulic Flange Adapter Notes for 14 – 24-inch/DN350 – DN600 Sizes of Style 741 OGS *Vic-Flange* Adapters ..... 216
- Victaulic Flange Washer and Transition Ring Notes for 14 – 24-inch/DN350 – DN600 Sizes of Style 741 OGS *Vic-Flange* Adapters ..... 217
- Style 741 (OGS) *Vic-Flange* Adapter (14 – 24-inch/ DN350 – DN600 sizes) ..... 218
- Grinding Instructions for Projections on Style 441 and 743 Flange Adapters..... 223
- Grinding Instructions for Teeth on Style 741, 841, and 744 Flange Adapters..... 224

**ADVANCED GROOVE SYSTEM (AGS) VIC-FLANGE ADAPTER FOR AGS GROOVED-END PIPE..... 225**

- Victaulic Flange Adapter Notes for 14 – 24-inch/ DN350 – DN600 Sizes of Style W741 AGS *Vic-Flange* Adapters ..... 226
- Victaulic Flange Washer and Transition Ring Notes for 14 – 24-inch/DN350 – DN600 Sizes of Style W741 AGS *Vic-Flange* Adapters ..... 227
- Style W741 AGS *Vic-Flange* Adapter (ANSI Class 125/150).. 228

<b>COUPLINGS FOR PLAIN-END PIPE/FITTINGS .....</b>	<b>233</b>
Style 99 <i>Roust-A-Bout</i> Coupling (12-inch/DN300 and Smaller Sizes) .....	234
Style 99 <i>Roust-A-Bout</i> Coupling (14-inch/DN350 and Larger Sizes) .....	241
Instructions for Reassembly of Style 99 Couplings .....	246
<b>HOLE-CUT PRODUCTS .....</b>	<b>247</b>
Style 422 Stainless Steel <i>Mechanical-T</i> Outlet.....	248
Style 912 FireLock™ Low-Profile Sprinkler-Tee (Available in Europe Only) .....	254
Style 920 <i>Mechanical-T</i> Outlet.....	258
Style 920N <i>Mechanical-T</i> Outlet .....	258
Style L920N <i>Mechanical-T</i> Outlet .....	258
Style 922 FireLock™ Outlet-T.....	265
Style 923 Strapless Outlet .....	270
Style 924 Strapless Thermometer Outlet.....	270
Style 926 <i>Mechanical-T</i> Spigot .....	275
<b>END CAPS AND TEST CAP KIT .....</b>	<b>281</b>
Victaulic End Cap Installation Safety Instructions .....	282
Safety Instructions for No. T-60 Test Caps or End Caps Installed for System Pressure Testing .....	284
Victaulic End Cap Removal Safety Instructions.....	285
No. T-60 Test Cap Installation and Use Instructions.....	286
<b>VALVE INSTALLATION INSTRUCTIONS .....</b>	<b>287</b>
Butterfly Valves .....	288
Adjusting the Travel Limit Stops for Vic-300™ MasterSeal™ Butterfly Valves with Gear Operators .....	290
Adjusting the Travel Limit Stops for 10 – 12-inch/ DN250 – DN300 Series 765 and 705 Butterfly Valves with Gear Operators.....	293
Check Valves.....	295
Ball Valves.....	297
Plug Valves.....	298
Gate Valves .....	299
<b>FIRE PUMP TEST METER INSTALLATION INSTRUCTIONS .....</b>	<b>301</b>
Series 735 Fire Pump Test Meter .....	302
<b>RESOURCES.....</b>	<b>303</b>
<b>PRODUCT DATA .....</b>	<b>315</b>
<b>FACILITIES LOCATIONS .....</b>	<b>B/C</b>

# INTRODUCTION

This I-100 Field Installation Handbook contains important information regarding pipe preparation and installation of 24-inch/DN600 and smaller Victaulic® mechanical piping products for carbon steel, stainless steel, aluminum, and CPVC/PVC pipe. For installation of Victaulic Copper Connection products, refer to the I-600 Field Installation Handbook.

Always follow good piping practices and local building codes and requirements. Specified pressures, temperatures, external loads, internal loads, performance standards, and tolerances shall never be exceeded.

Qualified engineers shall reference Victaulic Section 26 publications and publication 05.01 for additional information regarding special conditions, code requirements, and the use of safety factors. These publications can be downloaded at [victaulic.com](http://victaulic.com).

Products featured in this handbook are designed for use only with pipe that is specified by a system designer/engineer or contractor and then prepared to Victaulic specifications.

Victaulic grooved pipe couplings are designed for use only with pipe that is grooved to Victaulic specifications. In addition, Victaulic grooved pipe couplings are for use only with Victaulic grooved-end fittings, valves, and related grooved-end components. Victaulic grooved pipe couplings are not intended for use with plain-end pipe and/or fittings.

Victaulic plain-end pipe couplings are designed for use only with plain-end or beveled-end steel pipe and Victaulic plain-end fittings, unless indicated otherwise. Victaulic plain-end pipe couplings shall not be used with grooved-end or threaded pipe and/or fittings.

Victaulic gaskets are designed to perform in a wide range of temperatures and operating conditions. As with all installations, there is a direct relationship between temperature, continuity of service, and gasket life. Always reference Victaulic publication 05.01 to determine gasket material grades that may be specified for each application.

The term “mating component” used throughout this handbook applies to pipe, fitting, valve, or accessory ends that are prepared to the appropriate Victaulic groove specification.

Metric values listed throughout this handbook are converted from the Imperial values and may be rounded.

In addition to this I-100, Victaulic offers field installation handbooks, installation sheets, or installation tags for mechanical piping products that join alternate piping materials or other dedicated groove profile technologies. These instructions are shipped with the applicable product and can be downloaded at [victaulic.com](http://victaulic.com).



**SCAN QR CODE FOR ADDITIONAL FIELD INSTALLATION  
HANDBOOKS THAT VICTAULIC OFFERS**

**ADDITIONAL COPIES OF FIELD INSTALLATION HANDBOOKS ARE  
AVAILABLE FROM YOUR LOCAL VICTAULIC SALES REPRESENTATIVE**

## NOTICE

- Victaulic maintains a policy of continuous product improvement. Therefore, Victaulic reserves the right to change product specifications, designs, and standard equipment without notice and without incurring obligation.
- **VICTAULIC IS NOT RESPONSIBLE FOR SYSTEM DESIGN, NOR DOES THE COMPANY ASSUME ANY RESPONSIBILITY FOR SYSTEMS THAT ARE DESIGNED IMPROPERLY.**
- This handbook is not intended to be a substitute for competent, professional engineering/piping system design and installation, which are prerequisites for any product application.
- This handbook is intended for use only by professional piping system designers, engineers, and installers.
- The information published in this handbook and other Victaulic literature supersedes all previously published information.
- Drawings and/or pictures in this manual may be exaggerated for clarity.
- The field installation handbook contains trademarks, copyrights, and products with patented features that are the exclusive property of Victaulic.
- **WHILE EVERY EFFORT HAS BEEN MADE TO ENSURE ITS ACCURACY, VICTAULIC, ITS SUBSIDIARIES, AND ITS AFFILIATED COMPANIES MAKE NO EXPRESS OR IMPLIED WARRANTY OF ANY KIND REGARDING THE INFORMATION CONTAINED OR REFERENCED IN THIS HANDBOOK. ANYONE WHO USES THE INFORMATION CONTAINED HEREIN DOES SO AT THEIR RISK AND ASSUMES ANY LIABILITY THAT RESULTS FROM SUCH USE.**

## California Customers – Proposition 65 Compliance

	<p><b>WARNING:</b> The painted surface of these products can expose you to chemicals, including BBP, which are known to the State of California to cause birth defects or other reproductive harm. For more information, go to <a href="http://www.p65warnings.ca.gov">www.p65warnings.ca.gov</a>.</p> <p><b>WARNING:</b> Grades V and M2 can expose you to trace amounts of chemicals, such as ethylene thiourea, which are known to the State of California to cause cancer and birth defects or other reproductive harm. For more information, go to <a href="http://www.p65warnings.ca.gov">www.p65warnings.ca.gov</a>.</p> <p><b>WARNING:</b> Brass components, even those manufactured from “low lead” or “no lead” brass, can expose you to trace amounts of chemicals, such as lead, which are known to the State of California to cause cancer and birth defects or other reproductive harm. For more information, go to <a href="http://www.p65warnings.ca.gov">www.p65warnings.ca.gov</a>.</p>
--	---

## Canadian Customers – CSA B51 Compliance

For applications within the scope of CSA B51, “Boiler, Pressure Vessel and Pressure Piping Code,” please contact Victaulic for the most up-to-date Canadian Registration Numbers, approved products, and temperature ratings.

## Hazard Identification

Definitions for identifying the various hazard levels are provided below.



This safety alert symbol indicates important safety messages. When you see this symbol throughout this handbook, be alert to the possibility of personal injury. Carefully read and fully understand the message that follows.

### **DANGER**

- The use of the word “DANGER” identifies an immediate hazard with a likelihood of death or serious personal injury if instructions, including recommended precautions, are not followed.

### **WARNING**

- The use of the word “WARNING” identifies the presence of hazards or unsafe practices that could result in death or serious personal injury if instructions, including recommended precautions, are not followed.

### **CAUTION**

- The use of the word “CAUTION” identifies possible hazards or unsafe practices that could result in personal injury and product or property damage if instructions, including recommended precautions, are not followed.

### **NOTICE**

- The use of the word “NOTICE” identifies special instructions that are important but not related to hazards.

# Pipe Preparation and Grooving Specifications

# PIPE PREPARATION

---

Pipe shall be prepared to Victaulic specifications outlined for each product style. Preparation may vary according to pipe material, wall thickness, outside diameter (“OD”) dimensions, and other factors. Refer to all pipe preparation and groove specification sections on the following pages for detailed information.

## TOOL RATINGS

---

### WARNING



- Before setting up and operating any Victaulic pipe preparation tools, read and understand the operating and maintenance manual that is shipped with the tool.
- Learn the operation requirements, applications, and potential hazards associated with the tool.

Failure to follow these instructions could cause improper product installation, resulting in death or serious personal injury and property damage.

### NOTICE

- AGS roll sets for use on both light-weight and standard-weight carbon steel pipe, as well as standard-weight stainless steel pipe, are distinguished by a black appearance with a yellow band.
- AGS roll sets for less than standard-weight stainless steel pipe are distinguished by a silver appearance with a black band.
- AGS roll sets **SHALL NOT** be mixed with roll sets for other groove profiles.

Victaulic offers pipe preparation tools that are designed for field use or shop fabrication. For detailed information on pipe preparation tool ratings and capacities, refer to Victaulic publication 24.01, which can be downloaded at [victaulic.com](http://victaulic.com). For information about maintenance and operation of pipe preparation tools, refer to the applicable operating and maintenance manual that is shipped with the tool and that can be downloaded at [victaulic.com](http://victaulic.com).

# PIPE LENGTHS SUITABLE FOR GROOVING

The table below identifies the minimum pipe lengths that can be grooved safely by using Victaulic Roll Grooving Tools. In addition, this table identifies the maximum pipe lengths that can be roll grooved without the use of a pipe stand. Pipe that exceeds the maximum lengths listed in this table requires the use of a pipe stand. For additional tool and pipe stand setup requirements, and for pipe lengths required for Victaulic Cut Grooving Tools, always refer to the operating and maintenance manual that is shipped with the applicable tool. Manuals and repair parts lists can be downloaded at [victaulic.com](http://victaulic.com).

Nominal Pipe Size inches/DN	Actual Pipe Outside Diameter inches/mm	Minimum Length that can be Grooved Safely with Victaulic Tool inches/mm	Maximum Length that can be Grooved Without Use of Pipe Stand inches/mm
¾ – 4 DN20 – DN100	1.050 – 4.500 26.9 – 114.3	8 205	36 915
	3.000 – 4.250 76.1 – 108.0	8 205	36 915
4½ – 5	5.000 – 5.563 127.0 – 141.3	8 205	32 815
	5.250 – 5.500 133.0 – 139.7	8 205	32 815
6 DN150	6.000 – 6.500 152.4 – 165.1	10 255	30 765
	6.625 168.3	10 255	28 715
8 DN200	8.000 – 8.500 203.2 – 216.3	10 255	24 610
	8.625 219.1	10 255	24 610
10 DN250	10.000 – 10.528 254.0 – 267.4	10 255	20 510
	10.750 273	10 255	20 510
12 DN300	12.000 – 12.539 304.8 – 318.5	12 305	18 460
	12.750 323.9	12 305	18 460
14 – 16 DN350 – DN400	14.000 – 16.000 355.6 – 406.4	12 305	16 410
	14.843 – 16.772 377.0 – 426.0	12 305	16 410
18 and Larger DN450 and Larger	18.000 and Larger 457.2 and Larger	<b>NOTE: Always use a pipe stand when roll grooving pipe in these sizes. DO NOT roll groove pipe lengths shorter than 18 inches/457 mm in these sizes.</b>	
	18.898 and Larger 480.0 and Larger		

If pipe is required that is shorter than the minimum length listed in this table, shorten the next-to-last piece so that the last piece is as long (or longer) than the minimum length specified.

**EXAMPLE:** A 20-foot, 4-inch/6.2-m length of 10-inch/DN250 diameter carbon steel pipe is required to finish a section and only 20-foot/6.1-m lengths are available. Instead of roll grooving a 20-foot/6.1-m length of carbon steel pipe and a 4-inch/102-mm length of carbon steel pipe, follow these steps:

1. Refer to the table above, and note that for 10-inch/DN250 diameter carbon steel pipe, the minimum length that can be roll grooved is 10 inches/255 mm.
2. Roll groove a 19-foot, 6-inch/5.9-m length of pipe and a 10-inch/255-mm length of pipe.

# EXPLANATION OF CRITICAL ROLL GROOVE AND CUT GROOVE SPECIFICATIONS – ORIGINAL GROOVE SYSTEM (OGS) AND ENDSEAL™

## ⚠ WARNING

- Pipe dimensions and groove dimensions shall be within the tolerances specified in the tables on the following pages to ensure proper joint performance.

### FOR OGS COUPLINGS WITH RATINGS ON LIGHT-WALL STAINLESS STEEL PIPE:

- Victaulic RX rolls SHALL be used when roll grooving light-wall stainless steel pipe for use with OGS couplings. For complete stainless steel pipe preparation requirements, refer to Victaulic publication 17.01, which can be downloaded at victaulic.com.

Failure to follow these instructions could cause joint failure, resulting in death or serious personal injury and property damage.

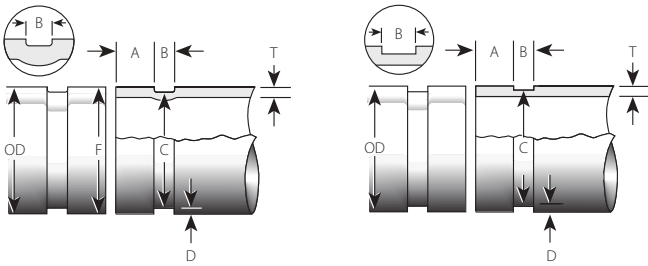

Roll Groove

Cut Groove

*Illustrations are exaggerated for clarity - Pipe and grooves are not shown to scale*

### Pipe Outside Diameter – Nominal NPS Pipe Size (ANSI B36.10) and Basic Metric Pipe Size (ISO 4200) –

The average pipe outside diameter shall not vary from the specifications listed in the tables on the following pages. Maximum allowable pipe ovality shall not vary by more than 1%. Greater variations between the major and minor diameters will result in difficult coupling assembly.

Victaulic recommends square-cut pipe. Beveled-end pipe may be used, provided that the wall thickness is standard wall (ANSI B36.10) or less and that the bevel meets ANSI B16.25 (37 1/2°) or ASTM A-53 (30°). **NOTE:** Roll grooving beveled-end pipe may result in unacceptable flare.

### For OGS, the maximum allowable tolerance from square-cut pipe ends is:

1/32 inch/0.8 mm for 3/4 – 3 1/2-inch/DN20 – DN90 sizes

1/16 inch/1.6 mm for 4 – 24-inch/DN100 – DN600 sizes

This is measured from the true square line.

### Square-cut pipe SHALL be used with Victaulic products containing FlushSeal™ and EndSeal™ gaskets.

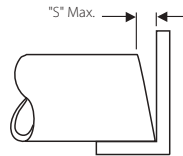

Any internal and external weld beads or seams shall be ground flush to the pipe surface. The inside diameter of the pipe end shall be cleaned to remove coarse scale, dirt, and other foreign material that might interfere with or damage grooving rolls. The front edge of the pipe end shall be uniform with no concave/convex surface features that will cause improper grooving roll tracking and result in difficulties during coupling assembly.

# EXPLANATION OF CRITICAL ROLL GROOVE AND CUT GROOVE SPECIFICATIONS – ORIGINAL GROOVE SYSTEM (OGS) AND ENDSEAL™ (CONTINUED)

**“A” Dimension** – The “A” dimension, or the distance from the pipe end to the groove, identifies the gasket seating area. This area between the groove and the pipe end shall be generally free from indentations, projections, weld seam anomalies, and roll marks to ensure a leak-tight seal. All oil, grease, loose paint, rust, scale, dirt, and cutting particles shall be removed.

**“B” Dimension** – The “B” dimension, or groove width, controls expansion, contraction, and angular deflection of flexible couplings by the distance it is located from the pipe and its width in relation to the coupling housings’ “key” width. The bottom of the groove shall be free from loose paint, rust, scale, dirt, and cutting particles that may interfere with proper coupling assembly.

**For EndSeal™ (roll groove):** The corners at the bottom of the groove shall be radiused 0.040 inch/1.02 mm.

**For EndSeal™ (cut groove):** The maximum permissible radius at the bottom of the groove is 0.015 inch/0.38 mm.

**“C” Dimension** – The “C” dimension is the average diameter at the base of the groove. This dimension shall be within the diameter’s tolerance and concentric with the OD for proper coupling fit. The groove shall be of uniform depth for the entire pipe circumference.

**“D” Dimension** – The “D” dimension is the normal depth of the groove and is a reference for a “trial groove” only. Variations in pipe OD affect this dimension and shall be altered, if necessary, to keep the “C” dimension within tolerance. The groove diameter shall conform to the “C” dimension described above.

**“F” Dimension (Roll Groove Only)** – Maximum allowable pipe-end flare diameter is measured at the extreme pipe-end diameter. **NOTE:** This applies to average (pi tape) and single-point readings.

**“T” Dimension** – The “T” dimension is the lightest grade (minimum nominal wall thickness) of pipe that is suitable for cut or roll grooving. Pipe that is less than the minimum nominal wall thickness for cut grooving may be suitable for roll grooving or adapted for Victaulic couplings by using *Vic-Ring* Adapters. *Vic-Ring* Adapters can be used in the following situations (contact Victaulic for details):

- When pipe is less than the minimum nominal wall thickness suitable for roll grooving
- When pipe outside diameter is too large to roll or cut groove
- When pipe is used in abrasive services

## NOTICE

Coatings that are applied to the interior surfaces of Victaulic grooved and plain-end pipe couplings listed in this handbook shall not exceed 0.010 inch/0.25 mm. This includes the bolt pad mating surfaces.

The coating thickness applied to the gasket sealing surface and within the groove on the roll-grooved pipe exterior shall not exceed 0.010 inch/0.25 mm. This pipe coating thickness will affect the roll groove specifications listed on the following pages. Allowances shall be made for the following:

- Pipe Outside Diameter, Gasket Seat “A”, Groove Diameter “C”, Minimum Allowable Wall Thickness “T”, and Maximum Allowable Flare Diameter “F” will be **INCREASED** by 0.020 inch/0.50 mm.
- Groove Width “B” will be **REDUCED** by 0.020 inch/0.50 mm.

# OGS ROLL GROOVE SPECIFICATIONS

## OGS Roll Groove Specifications for Carbon Steel Pipe and All Materials Grooved with Standard and RX Rolls

Nominal Pipe Size inches/DN	inches/millimeters												
	Pipe Outside Diameter		Gasket Seat "A"		Groove Width "B"			Groove Diameter "C"		Groove Depth "D" (ref.)	Min. Allow. Wall Thick. "T"	Max. Allow. Flare Dia. "F"	
	Actual	Max.	Min.	Basic	Max.	Min.	Basic	Max.	Min.				
¾ DN20	1.050	1.060	1.040	0.625	0.656	0.594	0.281	0.312	0.250	0.312	0.923	0.056	1.15
	26.9	26.9	26.4	15.9	16.7	15.1	7.1	7.9	6.4	23.8	23.4	1.5	29.2
1 DN25	1.315	1.328	1.302	0.625	0.656	0.594	0.281	0.312	0.250	1.190	1.175	0.063	1.43
	33.7	33.7	33.1	15.9	16.7	15.1	7.1	7.9	6.4	30.2	29.9	1.6	36.3
1¼ DN32	1.660	1.676	1.644	0.625	0.656	0.594	0.281	0.312	0.250	1.535	1.520	0.063	1.77
	42.4	42.6	41.8	15.9	16.7	15.1	7.1	7.9	6.4	39.0	38.6	1.6	45.0
1½ DN40	1.900	1.919	1.881	0.625	0.656	0.594	0.281	0.312	0.250	1.775	1.760	0.063	2.01
	48.3	48.7	47.8	15.9	16.7	15.1	7.1	7.9	6.4	45.1	44.7	1.6	51.1
2 DN50	2.244	2.267	2.222	0.625	0.656	0.594	0.344	0.375	0.313	2.118	2.102	0.063	2.35
	57.0	57.6	56.4	15.9	16.7	15.1	8.7	9.5	8.0	53.8	53.4	1.6	59.7
2 DN50	2.375	2.399	2.351	0.625	0.656	0.594	0.344	0.375	0.313	2.250	2.235	0.063	2.48
	60.3	60.9	59.7	15.9	16.7	15.1	8.7	9.5	8.0	57.2	56.8	1.6	63.0
2½ DN65	2.875	2.904	2.846	0.625	0.656	0.594	0.344	0.375	0.313	2.720	2.702	0.078	2.98
	73.0	73.8	72.3	15.9	16.7	15.1	8.7	9.5	8.0	69.1	68.6	2.0	75.7
3 DN80	3.000	3.030	2.970	0.625	0.656	0.594	0.344	0.375	0.313	2.845	2.827	0.078	3.10
	76.1	77.0	75.4	15.9	16.7	15.1	8.7	9.5	8.0	72.3	71.8	2.0	78.7
3 DN80	3.500	3.535	3.469	0.625	0.656	0.594	0.344	0.375	0.313	3.344	3.326	0.078	3.60
	88.9	89.8	88.1	15.9	16.7	15.1	8.7	9.5	8.0	84.9	84.5	2.0	91.4
3½ DN90	4.000	4.040	3.969	0.625	0.656	0.594	0.344	0.375	0.313	3.834	3.814	0.083	4.10
	101.6	102.6	100.8	15.9	16.7	15.1	8.7	9.5	8.0	97.4	96.9	2.1	104.1



# OGS ROLL GROOVE SPECIFICATIONS

## OGS Roll Groove Specifications for Carbon Steel Pipe and All Materials Grooved with Standard and RX Rolls (Continued)

Nominal Pipe Size inches/DN	inches/millimeters														
	Pipe Outside Diameter			Gasket Seat "A"			Groove Width "B"			Groove Diameter "C"			Groove Depth "D" (ref.)	Min. Allow. Wall Thick. "T"	Max. Allow. Flare Dia. "F"
	Actual	Max.	Min.	Basic	Max.	Min.	Basic	Max.	Min.	Max.	Min.	Max.			
4 DN100	4.250	4.293	4.219	0.625	0.656	0.594	0.344	0.375	0.313	4.064	4.084	0.083	0.078	4.35	
	108.0	109.0	107.2	15.9	16.7	15.1	8.7	9.5	8.0	103.2	103.7	2.1	2.0	110.5	
	4.500	4.545	4.469	0.625	0.656	0.594	0.344	0.375	0.313	4.314	4.334	0.083	0.078	4.60	
4½	114.3	115.4	113.5	15.9	16.7	15.1	8.7	9.5	8.0	109.6	110.1	2.1	2.0	116.8	
	5.000	5.050	4.969	0.625	0.656	0.594	0.344	0.375	0.313	4.814	4.834	0.083	0.078	5.10	
	127.0	128.3	126.2	15.9	16.7	15.1	8.7	9.5	8.0	122.3	122.8	2.1	2.0	129.5	
DN125	5.250	5.303	5.219	0.625	0.656	0.594	0.344	0.375	0.313	5.064	5.084	0.083	0.078	5.35	
	133.0	134.7	132.6	15.9	16.7	15.1	8.7	9.5	8.0	129.1	129.5	2.1	2.0	135.9	
	5.500	5.556	5.469	0.625	0.656	0.594	0.344	0.375	0.313	5.314	5.334	0.083	0.078	5.60	
5	139.7	141.1	138.9	15.9	16.7	15.1	8.7	9.5	8.0	135.5	135.5	2.1	2.0	142.2	
	5.563	5.619	5.532	0.625	0.656	0.594	0.344	0.375	0.313	5.373	5.395	0.084	0.078	5.66	
	141.3	142.7	140.5	15.9	16.7	15.1	8.7	9.5	8.0	136.5	137.0	2.1	2.0	143.8	
DN150	6.000	6.056	5.969	0.625	0.656	0.594	0.344	0.375	0.313	5.808	5.830	0.085	0.078	6.10	
	152.4	153.8	151.6	15.9	16.7	15.1	8.7	9.5	8.0	148.1	148.1	2.2	2.0	154.9	
	6.250	6.313	6.219	0.625	0.656	0.594	0.344	0.375	0.313	6.002	6.032	0.109	0.109	6.35	
6	159.0	160.4	158.0	15.9	16.7	15.1	8.7	9.5	8.0	152.5	153.2	2.8	2.8	161.3	
	6.500	6.563	6.469	0.625	0.656	0.594	0.344	0.375	0.313	6.308	6.330	0.085	0.078	6.60	
	165.1	166.7	164.3	15.9	16.7	15.1	8.7	9.5	8.0	160.2	160.8	2.2	2.0	167.6	
DN150	6.625	6.688	6.594	0.625	0.656	0.594	0.344	0.375	0.313	6.433	6.455	0.085	0.078	6.73	
	168.3	169.9	167.5	15.9	16.7	15.1	8.7	9.5	8.0	163.4	164.0	2.2	2.0	170.9	

# OGS ROLL GROOVE SPECIFICATIONS

## OGS Roll Groove Specifications for Carbon Steel Pipe and All Materials Grooved with Standard and RX Rolls (Continued)

Nominal Pipe Size inches/DN	inches/millimeters												Min. Allow. Wall Thick. "t"	Max. Allow. Flare Dia. "f"	
	Pipe Outside Diameter			Gasket Seat "A"			Groove Width "B"			Groove Diameter "C"					Groove Depth "D" (ref.)
	Actual	Max.	Min.	Basic	Max.	Min.	Basic	Max.	Min.	Max.	Min.	Max.			
#	8.000	8.063	7.969	0.750	0.781	0.719	0.469	0.500	0.438	7.791	7.816	7.791	0.092	0.109	8.17
	203.2	204.8	202.4	19.1	19.8	18.3	11.9	12.7	11.1	197.9	198.5	197.9	2.4	2.8	207.5
8	8.515	8.578	8.484	0.750	0.781	0.719	0.469	0.500	0.438	8.306	8.331	8.306	0.092	0.109	8.69
	216.3	217.9	215.5	19.1	19.8	18.3	11.9	12.7	11.1	211.6	211.6	211.0	2.4	2.8	220.7
DN200	8.625	8.688	8.594	0.750	0.781	0.719	0.469	0.500	0.438	8.416	8.441	8.416	0.092	0.109	8.80
	219.1	220.7	218.3	19.1	19.8	18.3	11.9	12.7	11.1	214.4	214.4	213.8	2.4	2.8	223.5
#	10.000	10.063	9.969	0.750	0.781	0.719	0.469	0.500	0.438	9.785	9.812	9.785	0.094	0.134	10.17
	254.0	255.6	253.2	19.1	19.8	18.3	11.9	12.7	11.1	248.5	249.2	248.5	2.4	3.4	258.3
10	10.528	10.591	10.497	0.750	0.781	0.719	0.469	0.500	0.438	10.340	10.340	10.313	0.094	0.134	10.70
	267.4	269.0	266.6	19.1	19.8	18.3	11.9	12.7	11.1	262.6	262.6	262.0	2.4	3.4	271.8
DN250	10.750	10.813	10.719	0.750	0.781	0.719	0.469	0.500	0.438	10.562	10.562	10.535	0.094	0.134	10.92
	273.0	274.7	272.3	19.1	19.8	18.3	11.9	12.7	11.1	268.3	268.3	267.6	2.4	3.4	277.4
#	12.000	12.063	11.969	0.750	0.781	0.719	0.469	0.500	0.438	11.751	11.781	11.751	0.109	0.156	12.17
	304.8	306.4	304.0	19.1	19.8	18.3	11.9	12.7	11.1	299.2	299.2	298.5	2.8	4.0	309.1
12	12.539	12.602	12.508	0.750	0.781	0.719	0.469	0.500	0.438	12.291	12.321	12.291	0.109	0.156	12.71
	318.5	320.1	317.7	19.1	19.8	18.3	11.9	12.7	11.1	312.2	313.0	312.2	2.8	4.0	322.8
DN300	12.750	12.813	12.719	0.750	0.781	0.719	0.469	0.500	0.438	12.501	12.531	12.501	0.109	0.156	12.92
	323.9	325.5	323.1	19.1	19.8	18.3	11.9	12.7	11.1	318.3	318.3	317.5	2.8	4.0	328.2
14*	14.000	14.063	13.969	0.938	0.969	0.907	0.469	0.500	0.438	13.781	13.781	13.751	0.109	0.156	14.16
	355.6	357.2	354.8	23.8	24.6	23.0	11.9	12.7	11.1	349.3	350.0	349.3	2.8	4.0	359.7
DN350															



# OGS ROLL GROOVE SPECIFICATIONS

OGS Roll Groove Specifications for Carbon Steel Pipe and All Materials Grooved with Standard and RX Rolls (Continued)

Nominal Pipe Size inches/DN	inches/millimeters														
	Pipe Outside Diameter			Gasket Seat "A"			Groove Width "B"			Groove Diameter "C"			Groove Depth "D" (ref.)	Min. Allow. Wall Thick. "T"	Max. Allow. Flare Dia. "F"
	Actual	Max.	Min.	Basic	Max.	Min.	Basic	Max.	Min.	Max.	Min.	Max.			
15 DN375	14.843	14.937	14.811	0.938	0.969	0.907	0.469	0.500	0.438	14.611	14.581	0.116	0.177	15.00	
	377.0	379.4	376.2	23.8	24.6	23.0	11.9	12.7	11.1	371.1	370.4	2.9	4.5	381.0	
16* DN400	15.000	15.063	14.969	0.938	0.969	0.907	0.469	0.500	0.438	14.781	14.751	0.109	0.165	15.16	
	381.0	382.6	380.2	23.8	24.6	23.0	11.9	12.7	11.1	375.4	374.7	2.8	4.2	385.1	
16* DN400	16.000	16.063	15.969	0.938	0.969	0.907	0.469	0.500	0.438	15.781	15.751	0.109	0.165	16.16	
	406.4	408.0	405.6	23.8	24.6	23.0	11.9	12.7	11.1	400.8	400.1	2.8	4.2	410.5	
18* DN450	16.772	16.866	16.740	0.938	0.969	0.907	0.469	0.500	0.438	16.514	16.479	0.129	0.177	16.93	
	426.0	428.4	425.2	23.8	24.6	23.0	11.9	12.7	11.1	419.5	418.6	3.3	4.5	430.0	
18* DN450	18.000	18.063	17.969	1.000	1.031	0.969	0.469	0.500	0.438	17.781	17.751	0.109	0.188	18.16	
	457.2	458.8	456.4	25.4	26.2	24.6	11.9	12.7	11.1	451.6	450.9	2.8	4.8	461.3	
18.898 480.0	18.898	18.992	18.867	1.000	1.031	0.969	0.469	0.500	0.438	18.626	18.591	0.136	0.236	19.06	
	480.0	482.4	479.2	25.4	26.2	24.6	11.9	12.7	11.1	473.1	472.2	3.5	6.0	484.1	
20* DN500	20.000	20.063	19.969	1.000	1.031	0.969	0.469	0.500	0.438	19.781	19.751	0.109	0.188	20.16	
	508.0	509.6	507.2	25.4	26.2	24.6	11.9	12.7	11.1	502.4	501.7	2.8	4.8	512.1	
20.866 530.0	20.866	20.960	20.835	1.000	1.031	0.969	0.469	0.500	0.438	20.572	20.537	0.147	0.236	21.03	
	530.0	532.4	529.2	25.4	26.2	24.6	11.9	12.7	11.1	522.5	521.6	3.7	6.0	534.2	
22* DN550	22.000	22.063	21.969	1.000	1.031	0.969	0.500	0.531	0.469	21.656	21.626	0.172	0.188	22.20	
	558.8	560.4	558.0	25.4	26.2	24.6	12.7	13.5	11.9	550.1	549.3	4.4	4.8	563.9	
22.835 580.0	22.835	22.929	22.803	1.000	1.031	0.969	0.500	0.531	0.469	22.488	22.457	0.172	0.276	23.03	
	580.0	582.4	579.2	25.4	26.2	24.6	12.7	13.5	11.9	571.2	570.4	4.4	7.0	585.0	

# OGS ROLL GROOVE SPECIFICATIONS

## OGS Roll Groove Specifications for Carbon Steel Pipe and All Materials Grooved with Standard and RX Rolls (Continued)

Nominal Pipe Size inches/DN	inches/millimeters												
	Pipe Outside Diameter			Gasket Seat "A"		Groove Width "B"			Groove Diameter "C"		Groove Depth "D" (ref.)	Min. Allow. Wall Thick. "T"	Max. Allow. Flare Dia. "F"
	Actual	Max.	Min.	Basic	Max.	Min.	Basic	Max.	Min.	Max.			
24*	24.000	24.063	23.969	1.000	1.031	0.969	0.500	0.531	0.469	23.626	0.172	0.218	24.20
DN600	609.6	611.2	608.8	25.4	26.2	24.6	12.7	13.5	11.9	600.9	4.4	5.5	614.7
	24.803	24.897	24.772	1.000	1.031	0.969	0.500	0.531	0.469	24.424	0.172	0.276	25.00
	630.0	632.4	629.2	25.4	26.2	24.6	12.7	13.5	11.9	620.4	4.4	7.0	635.0

# Applies to JIS metric pipe sizes 200A, 250A, and 300A, respectively (JIS Specification G 3452; G 3454).

\* OGS grooving specifications. For Advanced Groove System (AGS) grooving specifications in these sizes, refer to Victaulic publication 25.09, which can be downloaded at victaulic.com.

# ENDSEAL™ “ES” ROLL GROOVE SPECIFICATIONS

## EndSeal™ “ES” Roll Groove Specifications for Standard-Wall or Plastic-Coated Pipe Joined with Style HP-70ES EndSeal™ Couplings

Nominal Pipe Size inches/DN	inches/millimeters													
	Pipe Outside Diameter			Gasket Seat “A”		Groove Width “B”			Groove Diameter “C”			Groove Depth “D” (ref.)	Min. Allow. Wall Thick. “T”	Max. Allow. Flare Dia. “F”
	Actual	Max.	Min.	Max.	Min.	Max.	Min.	Max.	Min.	Max.	Min.			
2 DN50	2.375	2.399	2.351	0.572	0.552	0.265	0.250	2.250	2.235	0.063	0.065	2.480		
	60.3	60.9	59.7	14.5	14.0	6.7	6.4	57.2	56.8	1.6	1.7	63.0		
2½	2.875	2.904	2.846	0.572	0.552	0.265	0.250	2.720	2.702	0.078	0.083	2.980		
	73.0	73.8	72.3	14.5	14.0	6.7	6.4	69.1	68.6	2.0	2.1	75.7		
3 DN80	3.500	3.535	3.469	0.572	0.552	0.265	0.250	3.344	3.326	0.083	0.083	3.600		
	88.9	89.8	88.1	14.5	14.0	6.7	6.4	84.9	84.5	2.1	2.1	91.4		
4 DN100	4.500	4.545	4.469	0.610	0.590	0.320	0.300	4.334	4.314	0.083	0.083	4.600		
	114.3	115.4	113.5	15.5	15.0	8.1	7.6	110.1	109.6	2.1	2.1	116.8		
6 DN150	6.625	6.688	6.594	0.610	0.590	0.320	0.300	6.455	6.433	0.085	0.109	6.730		
	168.3	169.9	167.5	15.5	15.0	8.1	7.6	164.0	163.4	2.2	2.8	170.9		
8 DN200	8.625	8.688	8.594	0.719	0.699	0.410	0.390	8.441	8.416	0.092	0.109	8.800		
	219.1	220.7	218.3	18.3	17.8	10.4	9.9	214.4	213.8	2.3	2.8	223.5		
10 DN250	10.750	10.813	10.719	0.719	0.699	0.410	0.390	10.562	10.535	0.094	0.134	10.920		
	273.0	274.7	272.3	18.3	17.8	10.4	9.9	268.3	267.6	2.4	3.4	277.4		
12 DN300	12.750	12.813	12.719	0.719	0.699	0.410	0.390	12.531	12.501	0.109	0.156	12.920		
	323.9	325.5	323.1	18.3	17.8	10.4	9.9	318.3	317.5	2.8	4.0	328.2		

# OGS CUT GROOVE SPECIFICATIONS

## OGS Cut Groove Specifications for Steel and Other NPS Pipe

Nominal Pipe Size inches/DN	inches/millimeters												Min. Allow. Wall Thick. "T"	
	Pipe Outside Diameter			Gasket Seat "A"			Groove Width "B"			Groove Diameter "C"				Groove Depth "D" (ref.)
	Actual	Max.	Min.	Basic	Max.	Min.	Basic	Max.	Min.	Basic	Max.	Min.		
¾ DN20	1.050	1.060	1.040	0.625	0.656	0.594	0.313	0.344	0.282	0.938	0.923	0.056	0.113	
	26.9	26.9	26.4	15.9	16.7	15.1	8.0	8.7	7.2	23.8	23.4	1.5	2.9	
1 DN25	1.315	1.328	1.302	0.625	0.656	0.594	0.313	0.344	0.282	1.190	1.175	0.063	0.133	
	33.7	33.7	33.1	15.9	16.7	15.1	8.0	8.7	7.2	30.2	29.9	1.6	3.4	
1¼ DN32	1.660	1.676	1.644	0.625	0.656	0.594	0.313	0.344	0.282	1.535	1.520	0.063	0.140	
	42.4	42.6	41.8	15.9	16.7	15.1	8.0	8.7	7.2	39.0	38.6	1.6	3.6	
1½ DN40	1.900	1.919	1.881	0.625	0.656	0.594	0.313	0.344	0.282	1.775	1.760	0.063	0.145	
	48.3	48.7	47.8	15.9	16.7	15.1	8.0	8.7	7.2	45.1	44.7	1.6	3.7	
2 DN50	2.244	2.267	2.222	0.625	0.656	0.594	0.313	0.344	0.282	2.118	2.102	0.063	0.157	
	57.0	57.6	56.4	15.9	16.7	15.1	8.0	8.7	7.2	53.8	53.4	1.6	4.0	
2 DN50	2.375	2.399	2.351	0.625	0.656	0.594	0.313	0.344	0.282	2.250	2.235	0.063	0.154	
	60.3	60.9	59.7	15.9	16.7	15.1	8.0	8.7	7.2	57.2	56.8	1.6	3.9	
2½ DN65	2.875	2.904	2.846	0.625	0.656	0.594	0.313	0.344	0.282	2.720	2.702	0.078	0.188	
	73	73.8	72.3	15.9	16.7	15.1	8.0	8.7	7.2	69.1	68.6	2.0	4.8	
3 DN80	3.000	3.030	2.970	0.625	0.656	0.594	0.313	0.344	0.282	2.845	2.827	0.078	0.188	
	76.1	77.0	75.4	15.9	16.7	15.1	8.0	8.7	7.2	72.3	71.8	2.0	4.8	
3 DN80	3.500	3.535	3.469	0.625	0.656	0.594	0.313	0.344	0.282	3.344	3.326	0.078	0.188	
	88.9	89.8	88.1	15.9	16.7	15.1	8.0	8.7	7.2	84.9	84.5	2.0	4.8	
3½ DN90	4.000	4.040	3.969	0.625	0.656	0.594	0.313	0.344	0.282	3.834	3.814	0.083	0.188	
	101.6	102.6	100.8	15.9	16.7	15.1	8.0	8.7	7.2	97.4	96.9	2.1	4.8	

# OGS CUT GROOVE SPECIFICATIONS

OGS Cut Groove Specifications for Steel and Other NPS Pipe (Continued)

Nominal Pipe Size inches/DN	inches/millimeters													
	Pipe Outside Diameter			Gasket Seat "A"			Groove Width "B"			Groove Diameter "C"			Groove Depth "D" (ref.)	Min. Allow. Wall Thick. "T"
	Actual	Max.	Min.	Basic	Max.	Min.	Basic	Max.	Min.	Basic	Max.	Min.		
4	4.250	4.293	4.219	0.625	0.656	0.594	0.375	0.406	0.344	4.084	4.064	0.083	0.203	
	108	109.0	107.2	15.9	16.7	15.1	9.5	10.3	8.7	103.7	103.2	2.1	5.2	
DN100	4.500	4.545	4.469	0.625	0.656	0.594	0.375	0.406	0.344	4.334	4.314	0.083	0.203	
	114.3	115.4	113.5	15.9	16.7	15.1	9.5	10.3	8.7	110.1	109.6	2.1	5.2	
4½	5.000	5.050	4.969	0.625	0.656	0.594	0.375	0.406	0.344	4.834	4.814	0.083	0.203	
	127	128.3	126.2	15.9	16.7	15.1	9.5	10.3	8.7	122.8	122.3	2.1	5.2	
5	5.250	5.303	5.219	0.625	0.656	0.594	0.375	0.406	0.344	5.084	5.064	0.083	0.203	
	133	134.7	132.6	15.9	16.7	15.1	9.5	10.3	8.7	129.1	128.6	2.1	5.2	
DN125	5.500	5.556	5.469	0.625	0.656	0.594	0.375	0.406	0.344	5.334	5.314	0.083	0.203	
	139.7	141.1	138.9	15.9	16.7	15.1	9.5	10.3	8.7	135.5	135.0	2.1	5.2	
5	5.563	5.619	5.532	0.625	0.656	0.594	0.375	0.406	0.344	5.395	5.373	0.084	0.203	
	141.3	142.7	140.5	15.9	16.7	15.1	9.5	10.3	8.7	137.0	136.5	2.1	5.2	
6	6.000	6.056	5.969	0.625	0.656	0.594	0.375	0.406	0.344	5.830	5.808	0.085	0.219	
	152.4	153.8	151.6	15.9	16.7	15.1	9.5	10.3	8.7	148.1	147.5	2.2	5.6	
6	6.250	6.313	6.219	0.625	0.656	0.594	0.375	0.406	0.344	6.032	6.002	0.109	0.246	
	159	160.4	158.0	15.9	16.7	15.1	9.5	10.3	8.7	153.2	152.5	2.8	6.3	
6	6.500	6.563	6.469	0.625	0.656	0.594	0.375	0.406	0.344	6.330	6.308	0.085	0.219	
	165.1	166.7	164.3	15.9	16.7	15.1	9.5	10.3	8.7	160.8	160.2	2.2	5.6	
DN150	6.625	6.688	6.594	0.625	0.656	0.594	0.375	0.406	0.344	6.455	6.433	0.085	0.219	
	168.3	169.9	167.5	15.9	16.7	15.1	9.5	10.3	8.7	164.0	163.4	2.2	5.6	

# OGS CUT GROOVE SPECIFICATIONS

## OGS Cut Groove Specifications for Steel and Other NPS Pipe (Continued)

Nominal Pipe Size inches/DN	inches/millimeters													
	Pipe Outside Diameter			Gasket Seat "A"			Groove Width "B"			Groove Diameter "C"		Groove Depth "D" (ref.)	Min. Allow. Wall Thick. "T"	
	Actual	Max.	Min.	Basic	Max.	Min.	Basic	Max.	Min.	Max.	Min.			
	8.000 203.2	8.063 204.8	7.969 202.4	0.750 19.1	0.781 19.8	0.719 18.3	0.438 11.1	0.469 11.9	0.407 10.3	7.816 198.5	7.791 197.9	0.092 2.4	0.238 6.1	
#	8.515 216.3	8.578 217.9	8.484 215.5	0.750 19.1	0.781 19.8	0.719 18.3	0.438 11.1	0.469 11.9	0.407 10.3	8.331 211.6	8.306 211.0	0.092 2.4	0.238 6.1	
8 DN200	8.625 219.1	8.688 220.7	8.594 218.3	0.750 19.1	0.781 19.8	0.719 18.3	0.438 11.1	0.469 11.9	0.407 10.3	8.441 214.4	8.416 213.8	0.092 2.4	0.238 6.1	
	10.000 254	10.063 255.6	9.969 253.2	0.750 19.1	0.781 19.8	0.719 18.3	0.500 12.7	0.531 13.5	0.469 11.9	9.812 249.2	9.785 248.5	0.094 2.4	0.250 6.4	
#	10.528 267.4	10.591 269.0	10.497 266.6	0.750 19.1	0.781 19.8	0.719 18.3	0.500 12.7	0.531 13.5	0.469 11.9	10.340 262.6	10.313 262.0	0.094 2.4	0.250 6.4	
10 DN250	10.750 273	10.813 274.7	10.719 272.3	0.750 19.1	0.781 19.8	0.719 18.3	0.500 12.7	0.531 13.5	0.469 11.9	10.562 268.3	10.535 267.6	0.094 2.4	0.250 6.4	
	12.000 304.8	12.063 306.4	11.969 304.0	0.750 19.1	0.781 19.8	0.719 18.3	0.500 12.7	0.531 13.5	0.469 11.9	11.781 299.2	11.751 298.5	0.109 2.8	0.279 7.1	
#	12.539 318.5	12.602 320.1	12.508 317.7	0.750 19.1	0.781 19.8	0.719 18.3	0.500 12.7	0.531 13.5	0.469 11.9	12.321 313.0	12.291 312.2	0.109 2.8	0.279 7.1	
12 DN300	12.750 323.9	12.813 325.5	12.719 323.1	0.750 19.1	0.781 19.8	0.719 18.3	0.500 12.7	0.531 13.5	0.469 11.9	12.531 318.3	12.501 317.5	0.109 2.8	0.279 7.1	
14* DN350	14.000 355.6	14.063 357.2	13.969 354.8	0.938 23.8	0.969 24.6	0.907 23.0	0.500 12.7	0.531 13.5	0.469 11.9	13.781 350.0	13.751 349.3	0.109 2.8	0.281 7.1	



# OGS CUT GROOVE SPECIFICATIONS

## OGS Cut Groove Specifications for Steel and Other NPS Pipe (Continued)

Nominal Pipe Size inches/DN	inches/millimeters															
	Pipe Outside Diameter			Gasket Seat "A"			Groove Width "B"			Groove Diameter "C"			Groove Depth "D" (ref.)	Min. Allow. Wall Thick. "T"		
	Actual	Max.	Min.	Basic	Max.	Min.	Basic	Max.	Min.	Max.	Min.	Max.				
15 DN380	14.843	14.937	14.811	0.938	0.969	0.907	0.500	0.531	0.469	14.581	14.611	14.581	0.116	0.315		
	377.0	379.4	376.2	23.8	24.6	23.0	12.7	13.5	11.9	371.1	371.1	370.4	2.9	8.0		
16* DN400	15.000	15.063	14.969	0.938	0.969	0.907	0.500	0.531	0.469	14.751	14.781	14.751	0.109	0.312		
	381	382.6	380.2	23.8	24.6	23.0	12.7	13.5	11.9	374.7	375.4	374.7	2.8	7.9		
18* DN450	16.000	16.063	15.969	0.938	0.969	0.907	0.500	0.531	0.469	15.751	15.781	15.751	0.109	0.312		
	406.4	408.0	405.6	23.8	24.6	23.0	12.7	13.5	11.9	400.1	400.8	400.1	2.8	7.9		
20* DN500	16.772	16.866	16.740	0.938	0.969	0.907	0.500	0.531	0.469	16.479	16.514	16.479	0.129	0.335		
	426	428.4	425.2	23.8	24.6	23.0	12.7	13.5	11.9	418.6	419.5	418.6	3.3	8.5		
18* DN450	18.000	18.063	17.969	1.000	1.031	0.969	0.500	0.531	0.469	17.751	17.781	17.751	0.109	0.312		
	457	458.8	456.4	25.4	26.2	24.6	12.7	13.5	11.9	450.9	451.6	450.9	2.8	7.9		
20* DN500	18.898	18.992	18.863	1.000	1.031	0.969	0.500	0.531	0.469	18.591	18.626	18.591	0.136	0.354		
	480	482.4	497.1	25.4	26.2	24.6	12.7	13.5	11.9	473.1	473.1	472.2	3.5	9.0		
20* DN500	20.000	20.063	19.969	1.000	1.031	0.969	0.500	0.531	0.469	19.751	19.781	19.751	0.109	0.312		
	508	509.6	507.2	25.4	26.2	24.6	12.7	13.5	11.9	502.4	502.4	501.7	2.8	7.9		
22* DN550	20.866	20.960	20.835	1.000	1.031	0.969	0.500	0.531	0.469	20.537	20.572	20.537	0.147	0.354		
	530	532.4	529.2	25.4	26.2	24.6	12.7	13.5	11.9	522.5	522.5	521.6	3.7	9.0		
22* DN550	22.000	22.063	21.969	1.000	1.031	0.969	0.563	0.594	0.532	21.626	21.656	21.626	0.172	0.375		
	559	560.4	558.0	25.4	26.2	24.6	14.3	15.1	13.5	549.3	550.1	549.3	4.4	9.5		
22.835 580	22.835	22.929	22.803	1.000	1.031	0.969	0.563	0.594	0.532	22.457	22.488	22.457	0.172	0.375		
	580	582.4	579.2	25.4	26.2	24.6	14.3	15.1	13.5	570.4	571.2	570.4	4.4	9.5		

# OGS CUT GROOVE SPECIFICATIONS

## OGS Cut Groove Specifications for Steel and Other NPS Pipe (Continued)

Nominal Pipe Size inches/DN		inches/millimeters												Min. Allow. Wall Thick. "T"
		Pipe Outside Diameter		Gasket Seat "A"		Groove Width "B"			Groove Diameter "C"		Groove Depth "D" (ref.)			
		Actual	Max.	Min.	Basic	Max.	Min.	Basic	Max.	Min.		Max.		
24*	24.000 610	24.063 611.2	23.969 608.8	1.000 25.4	1.031 26.2	0.969 24.6	0.563 14.3	0.594 15.1	0.532 13.5	23.656 600.9	23.626 600.1	0.172 4.4	0.375 9.5	
	24.803 630	24.897 632.4	24.772 629.2	1.000 25.4	1.031 26.2	0.969 24.6	0.563 14.3	0.594 15.1	0.532 13.5	24.459 621.3	24.424 620.4	0.172 4.4	0.394 10.0	

# Applies to JIS metric pipe sizes 200A, 250A, and 300A, respectively (JIS Specification G 3452; G 3454).

\* OGS grooving specifications. For Advanced Groove System (AGS) grooving specifications in these sizes, contact Victaulic.

# ENDSEAL™ “ES” CUT GROOVE SPECIFICATIONS

## EndSeal™ “ES” Cut Groove Specifications for Standard or Heavier-Wall Pipe or Plastic-Coated Pipe Joined with Style HP-70ES EndSeal™ Couplings

Nominal Pipe Size inches/DN	inches/millimeters													
	Pipe Outside Diameter			Gasket Seat “A”			Groove Width “B”			Groove Diameter “C”			Groove Depth “D” (ref.)	Min. Allow. Wall Thick. “T”
	Actual	Max.	Min.	Basic	Max.	Min.	Basic	Max.	Min.	Max.	Min.	Max.		
2 DN50	2.375	2.399	2.351	0.562	0.572	0.552	0.255	0.265	0.250	2.250	2.235	0.063	0.154	
	60.3	60.9	59.7	14.3	14.5	14.0	6.5	6.7	6.4	57.2	56.8	1.6	3.9	
2½	2.875	2.904	2.846	0.562	0.572	0.552	0.255	0.265	0.250	2.720	2.702	0.078	0.188	
	73.0	73.8	72.3	14.3	14.5	14.0	6.5	6.7	6.4	69.1	68.6	2.0	4.8	
3 DN80	3.500	3.535	3.469	0.562	0.572	0.552	0.255	0.265	0.250	3.344	3.326	0.078	0.188	
	88.9	89.8	88.1	14.3	14.5	14.0	6.5	6.7	6.4	84.9	84.5	2.0	4.8	
4 DN100	4.500	4.545	4.469	0.605	0.620	0.590	0.305	0.315	0.300	4.334	4.314	0.083	0.203	
	114.3	115.4	113.5	15.4	15.7	15.0	7.8	8.0	7.6	110.1	109.6	2.1	5.2	
6 DN150	6.625	6.688	6.594	0.605	0.620	0.590	0.305	0.315	0.300	6.455	6.433	0.085	0.219	
	168.3	169.9	167.5	15.4	15.7	15.0	7.8	8.0	7.6	164.0	163.4	2.2	5.6	
8 DN200	8.625	8.688	8.594	0.714	0.729	0.699	0.400	0.410	0.390	8.441	8.416	0.092	0.238	
	219.1	220.7	218.3	18.1	18.5	17.8	10.2	10.4	9.9	214.4	213.8	2.3	6.1	
10 DN250	10.750	10.813	10.719	0.714	0.729	0.699	0.400	0.410	0.390	10.562	10.535	0.094	0.250	
	273.0	274.7	272.3	18.1	18.5	17.8	10.2	10.4	9.9	268.3	267.6	2.4	6.4	
12 DN300	12.750	12.813	12.719	0.714	0.729	0.699	0.400	0.410	0.390	12.531	12.501	0.109	0.279	
	323.9	325.5	323.1	18.1	18.5	17.8	10.2	10.4	9.9	318.3	317.5	2.8	7.1	

# EXPLANATION OF CRITICAL ROLL GROOVE AND CUT GROOVE SPECIFICATIONS – FIRELOCK™ INNOVATIVE GROOVE SYSTEM



## ! WARNING

- Pipe dimensions and groove dimensions shall be within the tolerances specified in the tables on the following pages to ensure proper joint performance.

Failure to follow this instruction could cause joint failure, resulting in death or serious personal injury and property damage.

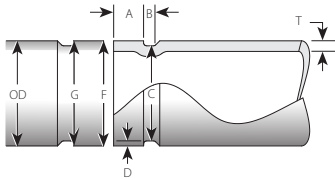

IGS Roll Groove

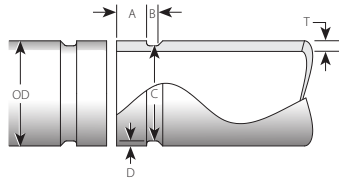

IGS Cut Groove

*Illustrations are exaggerated for clarity - Pipe and grooves are not shown to scale*

**Pipe Outside Diameter – Nominal NPS Pipe Size (ANSI B36.10) and Basic Metric Pipe Size (ISO 4200)** – The average pipe outside diameter shall not vary from the specifications listed in the tables on the following pages. Maximum allowable pipe ovality shall not vary by more than 1%. Greater variations between the major and minor diameters will result in difficult coupling assembly.

**FOR SCHEDULES 10 AND 40 NPS CARBON STEEL PIPE. CONTACT VICTAULIC REGARDING OTHER PIPE SPECIFICATIONS.**

The maximum allowable tolerance from square-cut pipe ends is  $\frac{1}{32}$  inch/0.8 mm. This is measured from the true square line.

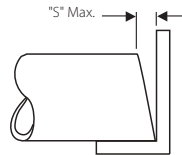

Any internal and external weld beads or seams shall be ground flush to the pipe surface. The inside diameter of the pipe end shall be cleaned to remove coarse scale, dirt, and other foreign material that might interfere with or damage grooving rolls. The front edge of the pipe end shall be uniform with no concave/convex surface features that will cause improper grooving roll tracking and result in difficulties during coupling assembly.

**“A” Dimension** – The “A” dimension, or the distance from the pipe end to the groove, identifies the gasket seating area. This area between the groove and the pipe end shall be generally free from indentations, projections, weld seam anomalies, and roll marks to ensure a leak-tight seal. All oil, grease, loose paint, rust, scale, dirt, and cutting particles shall be removed.

**“B” Dimension** – The “B” dimension identifies the groove width. The bottom of the groove shall be free from loose paint, rust, scale, dirt, and cutting particles that may interfere with proper coupling assembly. The corners at the bottom of the groove shall be radiused.

# EXPLANATION OF CRITICAL ROLL GROOVE AND CUT GROOVE SPECIFICATIONS – FIRELOCK™ INNOVATIVE GROOVE SYSTEM (CONTINUED)



**“C” Dimension** – The “C” dimension is the average diameter at the base of the groove. This dimension shall be within the diameter’s tolerance and concentric with the OD for proper coupling fit. The groove shall be of uniform depth for the entire pipe circumference.

**“D” Dimension** – The “D” dimension is the normal depth of the groove and is a reference for a “roll groove” only. Variations in pipe OD affect this dimension and shall be altered, if necessary, to keep the “C” dimension within tolerance. The groove diameter shall conform to the “C” dimension described above.

**“F” Dimension (Roll Groove Only)** – Maximum allowable pipe-end flare diameter is measured at the extreme pipe-end diameter (square cut or beveled). **NOTE:** This applies to average (pi tape) and single-point readings.

**“G” Dimension (Roll Groove Only)** – The “G” dimension identifies the groove shoulder and is the minimum diameter of the front side of the roll groove.

**“T” Dimension** – The “T” dimension is the lightest grade (minimum nominal wall thickness) of pipe that is suitable for cut or roll grooving.

## NOTICE

Coatings that are applied to the interior surfaces of Victaulic grooved and plain-end pipe couplings listed in this handbook shall not exceed 0.010 inch/0.25 mm. This includes the bolt pad mating surfaces.

The coating thickness applied to the gasket sealing surface and within the groove on the roll-grooved pipe exterior shall not exceed 0.010 inch/0.25 mm. This pipe coating thickness will affect the roll groove specifications listed on the following pages. Allowances shall be made for the following:

- Pipe Outside Diameter, Gasket Seat “A”, Groove Diameter “C”, Minimum Allowable Wall Thickness “T”, and Maximum Allowable Flare Diameter “F” will be **INCREASED** by 0.020 inch/0.50 mm.
- Groove Width “B” will be **REDUCED** by 0.020 inch/0.50 mm.

# IGS™ ROLL GROOVE SPECIFICATIONS

## IGS™ Roll Groove Specifications for Schedules 10 and 40 NPS Carbon Steel Pipe

Nominal Pipe Size inches/DN	inches/millimeters											
	Pipe Outside Diameter		Gasket Seat "A"		Groove Width "B"		Groove Diameter "C"		Groove Depth "D" (ref.)	Groove Shoulder "G"	Min. Allow. Wall Thick. "T"	Max. Allow. Flare Dia. "F"
	Actual	Max.	Min.	Basic	Max.	Min.	Basic	Max.				
1	1.315	1.346	1.300	0.375	0.405	0.345	0.150	0.160	0.140	1.170	0.063	1.370
DN25	33.7	34.2	33.0	9.5	10.3	8.8	3.8	4.1	3.6	29.7	1.6	34.8



# IGS™ CUT GROOVE SPECIFICATIONS

## IGS™ Cut Groove Specifications for Schedules 10 and 40 NPS Carbon Steel Pipe

Nominal Pipe Size inches/DN		inches/millimeters											
		Pipe Outside Diameter		Gasket Seat "A"		Groove Width "B"		Groove Diameter "C"		Groove Depth "D" (ref.)	Min. Allow. Wall Thick. "T"		
		Actual	Max.	Min.	Max.	Basic	Min.	Max.	Basic			Max.	Min.
1		1.315	1.346	1.300	0.375	0.405	0.345	0.140	0.150	1.190	1.175	0.063	0.133
DN25		33.7	34.2	33.0	9.5	10.3	8.8	3.6	3.8	30.2	29.9	1.6	3.4

# EXPLANATION OF CRITICAL STANDARD RADIUS CUT GROOVE SPECIFICATIONS FOR SCHEDULE 40 OR 80 CPVC AND PVC PIPE

## ⚠ WARNING

- Pipe dimensions and groove dimensions shall be within the tolerances specified in the tables on the following pages to ensure proper joint performance.
- Only products specified in Victaulic publications 32.01 and 33.02 shall be used on CPVC or PVC pipe that is prepared to the following standard radius cut groove specifications.
- DO NOT use PGS-300 system products on pipe that is prepared to standard radius cut groove specifications and vice versa. For more information on PGS-300 system products, refer to the I-350 Field Installation Handbook and Victaulic publications 25.18, 33.03, 33.05, 33.06, 33.07, 33.08, 33.16, and 33.17, which can be downloaded at victaulic.com.
- DO NOT use rigid, angled-bolt-pad couplings on CPVC or PVC pipe.

Failure to follow these instructions could cause joint failure, resulting in death or serious personal injury and property damage.

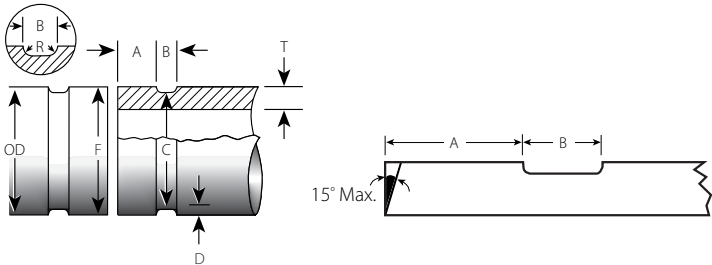

Illustrations are exaggerated for clarity - Pipe and grooves are not shown to scale

**Pipe Outside Diameter** – The average pipe outside diameter shall not vary from the specifications listed in the tables on the following pages.

**CPVC Pipe** – Manufactured to ASTM F441 with material confirming to Type IV, Grade 1 CPVC compound with a cell classification of 23447 or 24448, per ASTM D1784.

**PVC Pipe** – Based on modified PVC plastic pipe conforming to ASTM D1785-70, Type I, Grade I-PVC 1120 or Grade II-PVC 1220 at a maximum operating temperature of +75°F/+24°C. For other types of PVC pipe and other operating temperatures, contact Victaulic.

**The maximum allowable tolerance from square-cut pipe ends is:**

$\frac{1}{32}$  inch/0.8 mm for  $\frac{3}{4}$  – 3  $\frac{1}{2}$ -inch/DN20 – DN90 sizes  
 $\frac{3}{64}$  inch/1.2 mm for 4 – 6-inch/DN100 – DN150 sizes  
 $\frac{1}{16}$  inch/1.6 mm for 8-inch/DN200 and larger sizes  
This is measured from the true square line.

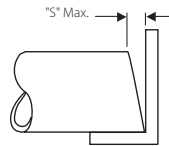

**NOTE:** Pipe with chamfers up to 15° may be cut grooved and used with products specified in Victaulic publications 32.01 and 33.02. DO NOT use pipe with chamfers greater than 15°.

**“A” Dimension** – The “A” dimension, or the distance from the pipe end to the groove, identifies the gasket seating area. This area between the groove and the pipe end shall be generally free from indentations, projections, and tool marks to ensure a leak-tight seal. All oil, grease, dirt, and cutting particles shall be removed.

# EXPLANATION OF CRITICAL STANDARD RADIUS CUT GROOVE SPECIFICATIONS FOR SCHEDULE 40 OR SCHEDULE 80 CPVC AND PVC PIPE (CONTINUED)

**“B” Dimension** – The “B” dimension, or groove width, controls expansion, contraction, and angular deflection of flexible couplings by the distance it is located from the pipe and its width in relation to the coupling housings’ “key” width. The bottom of the groove shall be free from dirt and cutting particles that may interfere with proper coupling assembly.

## NOTICE

**FOR STANDARD RADIUS CUT GROOVE WIDTHS PRIOR TO AUGUST 2016:**

- The 2 – 3-inch/DN50 – DN80 groove width was 0.312 inch/7.9 mm.
- The 4 – 6-inch/DN100 – DN150 groove width was 0.375 inch/9.5 mm.
- The 8-inch/DN200 groove width was 0.437 inch/11.1 mm.
- The 10 – 12-inch/DN250 – DN300 groove width was 0.500 inch/12.7 mm.
- Continued use of prior groove widths will not affect joint performance with Victaulic grooved pipe couplings specified in publications 32.01 and 33.02.

**“C” Dimension** – The “C” dimension is the average diameter at the base of the groove. This dimension shall be within the diameter’s tolerance and concentric with the OD for proper coupling fit. The groove shall be of uniform depth for the entire pipe circumference.

**“D” Dimension** – The “D” dimension is the normal depth of the groove and is a reference for a “trial groove” only. Variations in pipe OD affect this dimension and shall be altered, if necessary, to keep the “C” dimension within tolerance. The groove diameter shall conform to the “C” dimension described above.

**“R” Dimension** – The “R” dimension is the radius required at the bottom of the groove to eliminate point-loaded stress concentration.

## NOTICE

**Coatings that are applied to the interior surfaces of Victaulic grooved and plain-end pipe couplings listed in this handbook shall not exceed 0.010 inch/0.25 mm. This includes the bolt pad mating surfaces.**

# RADIUS CUT GROOVE SPECIFICATIONS

## Standard Radius Cut Groove Specifications for Schedule 40 or 80 CPVC and PVC Pipe

Nominal Pipe Size inches/DN	inches/millimeters											
	Pipe Outside Diameter		Gasket Seat "A"		Groove Width "B"			Groove Diameter "C"		Groove Depth "D" (ref.)	Groove Radius "R"	
	Actual	Max.	Min.	Basic	Max.	Min.	Basic	Max.	Min.			
¾ DN20	1.050	1.054	1.046	0.625	0.655	0.595	0.312	0.342	0.282	0.923	0.056	0.078
	26.7	26.8	26.6	15.9	16.6	15.1	7.9	8.7	7.2	23.4	1.4	2.0
1 DN25	1.315	1.320	1.310	0.625	0.655	0.595	0.312	0.342	0.282	1.175	0.062	0.078
	33.7	33.5	33.3	15.9	16.6	15.1	7.9	8.7	7.2	29.8	1.6	2.0
1¼ DN32	1.660	1.665	1.655	0.625	0.655	0.595	0.312	0.342	0.282	1.520	0.062	0.078
	42.4	42.3	42.0	15.9	16.6	15.1	7.9	8.7	7.2	38.6	1.6	2.0
1½ DN40	1.900	1.906	1.894	0.625	0.655	0.595	0.312	0.342	0.282	1.760	0.062	0.078
	48.3	48.4	48.1	15.9	16.6	15.1	7.9	8.7	7.2	44.7	1.6	2.0
2 DN50	2.375	2.381	2.369	0.625	0.655	0.595	0.344	0.374	0.314	2.235	0.062	0.078
	60.3	60.5	60.2	15.9	16.6	15.1	8.7	9.5	8.0	56.8	1.6	2.0
2½ DN60	2.875	2.882	2.868	0.625	0.655	0.595	0.344	0.374	0.314	2.702	0.078	0.078
	73.0	73.2	72.8	15.9	16.6	15.1	8.7	9.5	8.0	68.6	2.0	2.0
3 DN80	3.500	3.508	3.492	0.625	0.655	0.595	0.344	0.374	0.314	3.326	0.078	0.078
	88.9	89.1	88.7	15.9	16.6	15.1	8.7	9.5	8.0	84.5	2.0	2.0
4 DN100	4.500	4.509	4.491	0.625	0.655	0.595	0.344	0.374	0.314	4.314	0.083	0.078
	114.3	114.5	114.1	15.9	16.6	15.1	8.7	9.5	8.0	109.6	2.1	2.0
5 DN125	5.563	5.573	5.553	0.625	0.655	0.595	0.344	0.374	0.314	5.373	0.083	0.078
	141.3	141.6	141.0	15.9	16.6	15.1	8.7	9.5	8.0	136.5	2.1	2.0
6 DN150	6.625	6.636	6.614	0.625	0.655	0.595	0.344	0.374	0.314	6.433	0.085	0.078
	168.3	168.6	168.0	15.9	16.6	15.1	8.7	9.5	8.0	163.4	2.2	2.0



# RADIUS CUT GROOVE SPECIFICATIONS

Standard Radius Cut Groove Specifications for Schedule 40 or 80 CPVC and PVC Pipe (Continued)

Nominal Pipe Size inches/DN	inches/millimeters											
	Pipe Outside Diameter			Gasket Seat "A"			Groove Width "B"			Groove Diameter "C"		
	Actual	Max.	Min.	Basic	Max.	Min.	Basic	Max.	Min.	Max.	Min.	Groove Depth "D" (ref.)
8 DN200	8.625	8.640	8.610	0.750	0.780	0.720	0.469	0.499	0.439	8.416	0.092	0.078
	219.1	219.5	218.7	19.1	19.8	18.3	11.9	12.7	11.2	213.8	2.3	2.0
10 DN250	10.750	10.765	10.735	0.750	0.780	0.720	0.469	0.499	0.439	10.535	0.094	0.078
	273.0	273.4	272.7	19.1	19.8	18.3	11.9	12.7	11.2	267.6	2.4	2.0
12 DN300	12.750	12.765	12.735	0.750	0.780	0.720	0.469	0.499	0.439	12.501	0.109	0.078
	323.9	324.2	323.5	19.1	19.8	18.3	11.9	12.7	11.2	317.5	2.8	2.0
14 DN350	14.000	14.015	13.985	0.938	0.968	0.908	0.500	0.530	0.470	13.751	0.109	0.078
	355.6	356.0	355.2	23.8	24.6	23.1	12.7	13.5	11.9	349.3	2.8	2.0
16 DN400	16.000	16.019	15.981	0.938	0.968	0.908	0.500	0.530	0.470	15.751	0.109	0.078
	406.4	406.9	405.9	23.8	24.6	23.1	12.7	13.5	11.9	400.1	2.8	2.0

# PIPE END INSPECTION AND PREPARATION – ADVANCED GROOVE SYSTEM



Pipe ends shall be prepared and visually inspected in accordance with the requirements listed in this section.

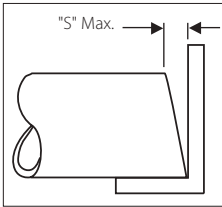

1. The maximum allowable tolerance from square-cut pipe ends (“S” dimension shown) is:

$\frac{1}{16}$  inch/1.6 mm for 14 – 20-inch/DN350 – DN500 – sizes  
 $\frac{3}{32}$  inch/2.4 mm for 22 – 24-inch/DN550 – DN600 sizes

This is measured from the true square line.

For 14 – 24-inch/DN350 – DN600 sizes, beveled-end pipe may be used, provided that the wall thickness is 0.375 inch/9.5 mm or less and that the bevel meets ASTM A53 and/or API 5L ( $30^\circ +5^\circ/0^\circ$ ). **NOTE: Roll grooving beveled-end pipe may result in unacceptable flare.**

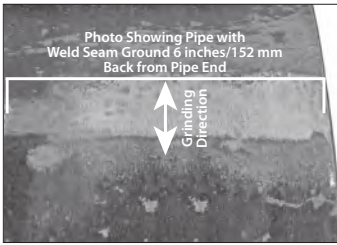

2. Prior to grooving, raised internal and external weld beads and seams shall be ground flush to the pipe surface a minimum of 6 inches/152 mm back from the pipe end. This area shall be generally free from indentations, projections, weld seam anomalies, and roll marks to ensure a leak-tight seal.

3. Pipe with external axial weld seams can be supported with Victaulic Adjustable Pipe Stands; however, the weld seam shall be smooth and rounded and at least three times as wide as it is high. External axial weld seams shall not exceed  $\frac{1}{8}$  inch/3.2 mm in height.

4. The inside diameter of the pipe end shall be cleaned to remove coarse scale, dirt, and other foreign material that might interfere with or damage grooving rolls.

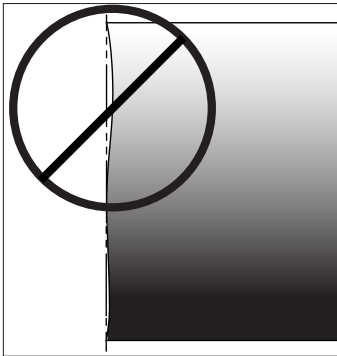

5. The front edge of the pipe end shall be uniform, with no concave/convex surface features that will cause improper grooving roll tracking and result in difficulties during coupling assembly. Refer to the drawing to the left for an unacceptable pipe end.

6. If pipe cut-off is required, Victaulic recommends the use of a mechanically-guided pipe cutting tool for proper pipe end preparation. Free-hand pipe end cutting is not recommended.

7. Always refer to the operating and maintenance manual for the pipe preparation tool and the specific installation instructions associated with the product for which you are preparing pipe. **For stainless steel pipe preparation requirements, always refer to Victaulic publication 17.01, which can be downloaded at victaulic.com.**

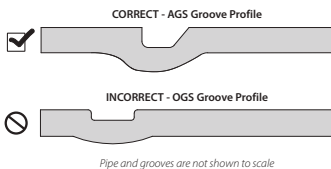

8. Groove the pipe in accordance with the AGS grooving specifications listed on the following pages. **When direct-grooving pipe for use with Style W07/LW07, W77, and W89 AGS Couplings or Style W741 AGS Vic-Flange Adapters, Victaulic AGS roll sets are required. DO NOT attempt to assemble AGS Couplings on pipe that is direct grooved with OGS roll sets.**



9. Clean the outside surface of the pipe, from the groove to the pipe end, to remove all oil, grease, loose paint, and dirt.

## PIPE END INSPECTION AND PREPARATION – **AGS** VIC-RING APPLICATIONS

For *Vic-Ring* applications, Type “B” or Type “D” AGS *Vic-Rings* are required for use with Style W07, W77 and W89 AGS Couplings. Pipe ends and *Vic-Rings* shall be prepared and visually inspected in accordance with the requirements listed in this section.

### **! WARNING**

- It is the welder's responsibility to verify that AGS *Vic-Rings* are welded correctly to the pipe, in accordance with project/site-specific welding standards and in conformance with the AGS *Vic-Ring* Weldment submittal drawing(s) provided for the specific project.
- The weld shall be capable of withstanding all thrust loads, in accordance with appropriate American Welding Society (AWS) specifications or other local or national codes and requirements. All welds shall be leak-tight.
- Applicable safety procedures shall be followed during the welding process.

Failure to follow these instructions could cause improper product installation, resulting in death or serious personal injury and property damage.

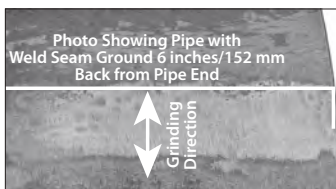

1. Prior to welding a *Vic-Ring* onto the pipe end, weld seams shall be ground flush to the pipe surface (outside diameter). Grind the weld seam from the pipe end to a minimum distance of 6 inches/ 152 mm back from the pipe end. This area shall be generally free from indentations, projections, and roll marks.

2. Weld the *Vic-Ring* onto the pipe end per the literature provided with the shipment and the specifications listed in Victaulic publication 16.11 for Style W07 Rigid Couplings, 16.12 for Style W77 Flexible Couplings, or 16.15 for Style W89 Rigid Couplings.



3. Clean the outside surface of the *Vic-Rings* to remove dirt and other foreign material.

# EXPLANATION OF CRITICAL AGS ROLL GROOVE SPECIFICATIONS



## ⚠ WARNING

- Pipe and groove dimensions shall be within the tolerances specified in the tables on the following pages to ensure proper joint performance.

### FOR ADVANCED GROOVE SYSTEM (AGS) COUPLINGS WITH RATINGS ON STAINLESS STEEL PIPE:

- Victaulic AGS RW rolls **SHALL** be used when roll grooving Schedule 40S/ Standard-Weight Type 304/316 pipe for use with AGS couplings.
- Victaulic AGS RWX rolls **SHALL** be used when roll grooving Schedule 5S, Schedule 10S, and Schedule 10 Type 304/316 pipe for use with AGS couplings.
- For complete stainless steel pipe preparation requirements, refer to Victaulic publication 17.01, which can be downloaded at victaulic.com.

Failure to follow these specifications could cause joint failure, resulting in death or serious personal injury and property damage.

## NOTICE

- Depending on pipe material strength and hardness, AGS grooves produce pipe growth that typically is  $\frac{1}{8}$  inch (0.125 inch/3.2 mm) per AGS groove. This typical growth may vary and should be estimated based on the specific material conditions. For a pipe length with an AGS roll groove at each end, the pipe length will grow approximately  $\frac{1}{4}$  inch (0.250 inch/6.4 mm) total. Therefore, the cut length should be adjusted to accommodate this growth. **EXAMPLE:** If you need a 24-inch/610-mm length of pipe that will contain an AGS roll groove at each end, cut the pipe to a length of approximately  $23\frac{3}{4}$  inches/603 mm to allow for this growth.

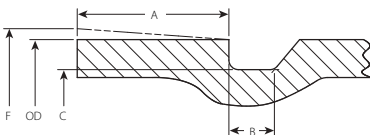

*Illustration is exaggerated for clarity - Pipe and groove are not shown to scale*

Pipe shall meet the physical and mechanical properties of ASTM A53, API 5L, AWWA C200, EN/BS10216-1, EN/BS10217-1, GB/T 3091, GB/T 8163, or other internationally recognized standards. Carbon steel pipe suitable for AGS roll grooving shall be Seamless, Electric-Welded (ERW), Longitudinal Seam Submerged-Arc Welded (SAW), Double Seam Submerged-Arc Welded (DSAW), or Helical Seam Submerged-Arc Welded (HSAW) construction.

### **Pipe Outside Diameter – Nominal NPS Pipe Size (ANSI B36.10) and Basic Metric**

**Pipe Size (ISO 4200)** – The average pipe outside diameter shall not vary from the specifications listed in the tables on the following pages. Maximum allowable pipe ovality shall not vary by more than 1%. Greater variations between the major and minor diameters will result in difficult coupling assembly.

**“A” Dimension** – The “A” dimension, or the distance from the pipe end to the groove, identifies the gasket seating area. This area between the groove and the pipe end shall be generally free from indentations, projections, weld seam anomalies, and roll marks to ensure a leak-tight seal. All oil, grease, loose paint, rust, scale, dirt, and cutting particles shall be removed.

# EXPLANATION OF CRITICAL AGS ROLL GROOVE SPECIFICATIONS (CONTINUED)



**“B” Dimension** – The “B” dimension, or groove width, controls expansion, contraction, and angular deflection of flexible couplings by the distance it is located from the pipe and its width in relation to the coupling housings’ “key” width. The bottom of the groove shall be free from loose paint, rust, scale, dirt, and cutting particles that may interfere with proper coupling assembly. The Groove Width “B” dimension will be achieved with properly maintained Victaulic tools that are equipped with Victaulic AGS roll sets.

**“C” Dimension** – The “C” dimension is the average diameter at the base of the groove. This dimension shall be within the diameter’s tolerance and concentric with the OD for proper coupling fit. The groove shall be of uniform depth for the entire pipe circumference.

**“D” Dimension** – The “D” dimension is the normal depth of the groove and is a reference for a “trial groove” only. Variations in pipe OD affect this dimension and shall be altered, if necessary, to keep the “C” dimension within tolerance. The groove diameter shall conform to the “C” dimension described above.

**“F” Dimension (Roll Groove Only)** – Maximum allowable pipe-end flare diameter is measured at the extreme pipe-end diameter. **NOTE:** This applies to average (pi tape) and single-point readings.

**Nominal Wall Thickness** – This is the nominal allowable pipe wall thickness that is suitable for roll grooving. Pipe that is less than the nominal wall thickness may be adapted for Victaulic AGS couplings by using AGS *Vic-Ring* Adapters. AGS *Vic-Ring* Adapters can be used in the following situations (contact Victaulic for details):

- When pipe is less than the nominal allowable pipe wall thickness that is suitable for roll grooving
- When pipe outside diameter is too large to roll groove
- When pipe is used in abrasive services

## NOTICE

Coatings that are applied to the interior surfaces of Victaulic AGS Couplings listed in this handbook shall not exceed 0.010 inch/0.25 mm. This includes the bolt pad mating surfaces.

The coating thickness applied to the gasket sealing surface and within the AGS groove on the pipe exterior or AGS *Vic-Ring* exterior shall not exceed 0.010 inch/0.25 mm. This pipe coating thickness will affect the roll groove specifications listed on the following pages. Allowances shall be made for the following:

- Pipe Outside Diameter, Gasket Seat “A”, Groove Diameter “C”, Minimum Allowable Wall Thickness “T”, and Maximum Allowable Flare Diameter “F” will be **INCREASED** by 0.020 inch/0.50 mm.
- Groove Width “B” will be **REDUCED** by 0.020 inch/0.50 mm.

# AGS ROLL GROOVE SPECIFICATIONS

## AGS Roll Groove Specifications for Carbon Steel and Stainless Steel Pipe (In Accordance with EN 10217, ASTM A-53, ASTM A-312, or API 5L)

Nominal Pipe Size inches/DN	inches/millimeters												Max. Allow. Flare Dia. "F"
	Pipe Outside Diameter			Nominal Wall Thickness for Grooving			Gasket Seat "A"			Groove Diameter "C"		Groove Width "B"	
	Actual	Max.	Min.	Carbon Steel	Stainless Steel (Less Than Standard Weight)	Basic	Max.	Min.	Max.	Min.			
14 DN350	14.000	14.093	13.969	0.220 - 0.750	0.188	1.500	1.531	1.437	13.500	13.455	0.455	14.23	
	355.6	358.0	354.8	5.6 - 19.1	4.8	38.1	38.9	36.5	342.9	341.8	11.6	361.4	
16 DN400	14.843	14.937	14.812	0.217 - 0.750	-	1.500	1.531	1.437	14.343	14.298	0.455	15.07	
	377.0	379.4	376.2	5.5 - 19.1	-	38.1	38.9	36.5	364.3	363.2	11.6	382.8	
16 DN400	16.000	16.093	15.969	0.250 - 0.750	0.188	1.500	1.531	1.437	15.500	15.455	0.455	16.23	
	406.4	408.8	405.6	6.4 - 19.1	4.8	38.1	38.9	36.5	393.7	392.6	11.6	412.2	
18 DN450	16.772	16.866	16.741	0.256 - 0.750	-	1.500	1.531	1.437	16.272	16.227	0.455	17.00	
	426.0	428.4	425.2	6.5 - 19.1	-	38.1	38.9	36.5	413.3	412.2	11.6	431.8	
18 DN450	18.000	18.093	17.969	0.250 - 0.750	0.188	1.500	1.531	1.437	17.500	17.455	0.455	18.23	
	457.2	459.6	456.4	6.4 - 19.1	4.8	38.1	38.9	36.5	444.5	443.4	11.6	463.0	
20 DN500	18.898	18.992	18.867	0.256 - 0.750	-	1.500	1.531	1.437	18.398	18.353	0.455	19.13	
	480.0	482.4	479.2	6.5 - 19.1	-	38.1	38.9	36.5	467.3	466.2	11.6	485.9	
20 DN500	20.000	20.093	19.969	0.250 - 0.750	0.218	1.500	1.531	1.437	19.500	19.455	0.455	20.23	
	508.0	510.4	507.2	6.4 - 19.1	5.5	38.1	38.9	36.5	495.3	494.2	11.6	513.8	
22 DN550	20.866	20.960	20.835	0.256 - 0.750	-	1.500	1.531	1.437	20.366	20.321	0.455	21.09	
	530.0	532.4	529.2	6.5 - 19.1	-	38.1	38.9	36.5	517.3	516.2	11.6	535.7	
22 DN550	22.000	22.093	21.969	0.250 - 0.750	0.218	1.500	1.531	1.437	21.500	21.455	0.455	22.23	
	558.8	561.2	558.0	6.4 - 19.1	5.5	38.1	38.9	36.5	546.1	545.0	11.6	564.6	
24 DN600	24.000	24.093	23.969	0.250 - 0.750	0.218	1.500	1.531	1.437	23.500	23.455	0.455	24.23	
	609.6	612.0	608.8	6.4 - 19.1	5.5	38.1	38.9	36.5	596.9	595.8	11.6	615.4	



# Important Gasket and Lubricant Information

# GASKET SELECTION AND LUBRICANT REQUIREMENTS

## CAUTION

- To ensure gasket performance, always specify the material grade that is suitable for the intended service.

Failure to select the proper material grade for the service may result in joint leakage and property damage.

During selection and verification of gasket material grades, always refer to Victaulic publications 05.01 and GSG-100, which can be downloaded at victaulic.com. For rubber-lined valves or other rubber-lined products, always reference the applicable Victaulic product publication for specific requirements.

Do not subject gaskets to temperatures beyond the specified limits. Excessive temperatures will degrade gasket performance.

## Gasket Color Code Reference

Grade	Compound	Color Code
<b>E</b>	EPDM	Green Stripe
<b>EHP</b>	EPDM	Red and Green Stripes
<b>E</b> (Type A)	EPDM	Violet Stripe
<b>E2</b>	EPDM	Double Green Stripes
<b>E3</b>	EPDM	Green and Silver Stripes
<b>EF</b>	EPDM	Green "X"
<b>EW</b>	EPDM	Green "W"
<b>T</b>	Nitrile	Orange Stripe
<b>T</b> (Type A)	Nitrile	Gray Gasket
<b>HMT</b> (High-Modulus Nitrile)	Nitrile	Orange and Silver Stripes
<b>T</b> (T-607 EndSeal™)	Nitrile	Gray Gasket
<b>M2</b>	Epichlorohydrin	White Stripe
<b>V</b>	Neoprene	Yellow Stripe
<b>L</b>	Silicone	Red Gasket
<b>A</b>	White Nitrile	White Gasket
<b>O</b>	Fluoroelastomer	Blue Stripe
<b>CHP-2</b>	Fluoroelastomer	Yellow and Copper Stripes
<b>P</b>	Fluoroelastomer Blend	Double Blue Stripes

## Lubrication of Gaskets

### ! CAUTION

#### FOR INSTALLATION-READY COUPLINGS:

- When specified, a thin coat of a compatible lubricant shall be applied only to the gasket sealing lips to help prevent the gasket from pinching, rolling, or tearing during installation. Reference the “NOTICE” on page 36 for information regarding products that may be provided with pre-lubricated gaskets.
- DO NOT use excessive lubricant on the gasket sealing lips.

#### FOR STANDARD COUPLINGS:

- When specified, a thin coat of a compatible lubricant shall be applied to the gasket sealing lips and exterior to help prevent the gasket from pinching, rolling, or tearing during installation.
- DO NOT use excessive lubricant on the gasket sealing lips and exterior.

Failure to use a compatible lubricant may cause gasket damage, resulting in joint leakage and property damage.

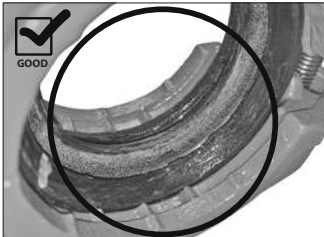

Properly Lubricated Installation-Ready Gasket with Thin Coating of Lubricant

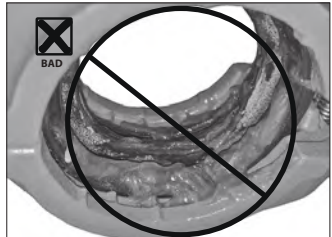

Improperly Lubricated Installation-Ready Gasket with Too Much Lubricant



Properly Lubricated Standard Gasket with Thin Coating of Lubricant

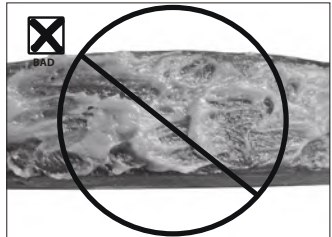

Improperly Lubricated Standard Gasket with Too Much Lubricant

A thin coating of a compatible lubricant is required to help prevent gasket pinching and to facilitate product installation. Always follow the specific product instructions featured in this handbook, and refer to the “Lubricant Compatibility for Gaskets” table on the following page. Publication 05.02, Victaulic Lubricant Safety Data Sheet (SDS), can be downloaded at [victaulic.com](http://victaulic.com).

### NOTICE

- Victaulic Lubricant shall not be mixed with Poly Olester (POE) Oil during installation.
- Prior to assembly, Victaulic recommends maintaining lubricant and gaskets at temperatures above 0°C/32°F to prevent the lubricant from freezing and to ease installation onto the pipe ends.

### Storage of Gaskets

Until the time of installation, Victaulic products with exposed elastomeric components shall be stored in typical warehouse conditions, where components are protected from outside environmental factors such as: sun exposure, ozone exposure, extreme temperatures, and extreme relative humidity (or as specified by national and local codes and standards for the jobsite).

## Lubricant Compatibility for Gaskets

The following recommendations are for the gasket materials listed. Commercial lubricants may contain multiple ingredients. Always refer to the lubricant manufacturer's recommendations for material compatibility. **NOTE:** Victaulic Lubricant shall not be mixed with Poly Olester (POE) Oil during installation.

	Victaulic Lubricant	Soap-Based Solutions	Glycerin	Silicone Grease	Silicone Spray	Corn Oil	Soybean Oil	Hydrocarbon-Based Oils	Petroleum-Based Greases
Compatible with EPDM Gaskets?	Yes	Yes	Yes	Yes	Not Recommended	Not Recommended	Not Recommended	Not Recommended	Not Recommended
Compatible with Nitrile Gaskets?	Yes	Yes	Yes	Yes	Not Recommended	Yes	Yes	Yes	Yes
Compatible with Epichlorohydrin Gaskets?	Yes	Yes	Yes	Yes	Not Recommended	Yes	Yes	Not Recommended	Not Recommended
Compatible with Neoprene Gaskets?	Not Recommended	Not Recommended	Yes	Yes	Not Recommended	Not Recommended	Not Recommended	Not Recommended	Not Recommended
Compatible with Silicone Gaskets?	Yes	Not Recommended	Yes	Not Recommended	Not Recommended	Not Recommended	Not Recommended	Not Recommended	Not Recommended
Compatible with Fluoroelastomer Gaskets?	Yes	Yes	Yes	Yes	Not Recommended	Yes	Yes	Yes	Yes

## Victaulic Lubricant Usage Guide

The following table provides the **approximate** number of common-size **standard** gaskets that can be lubricated with a 4.5-ounce/127.5-gram tube or a 1-quart/32-ounce/907-gram container of Victaulic Lubricant (lubricant applied to gasket sealing lips and exterior). These values have been calculated using a thin coating of Victaulic Lubricant, as described in this section, and do not take into account any overuse or spillage. **THE APPROXIMATE NUMBER OF GASKETS LISTED IN THIS TABLE CAN BE DOUBLED FOR INSTALLATION-READY PRODUCTS (LUBRICANT APPLIED ONLY TO GASKET SEALING LIPS).**

Approximate shelf life of Victaulic Lubricant in tubes is 2 years beyond the manufacture date stamped on the container. Approximate shelf life of Victaulic Lubricant in quarts is 1 year beyond the manufacture date stamped on the container.

Nominal Size inches DN	Actual Pipe Outside Diameter inches/mm	Approximate Number of Standard Gaskets	
		Per Tube	Per Quart
2 DN50	2.375 60.3	107	753
4 DN100	4.500 114.3	52	364
6 DN150	6.625 168.3	34	238
8 DN200	8.625 219.1	25	176
10 DN250	10.750 273.0	19	139
12 DN300	12.750 323.9	16	115
14 DN350	14.000 355.6	13	97
16 DN400	16.000 406.4	12	85
18 DN450	18.000 457	10	75
20 DN500	20.000 508	9	67
22 DN550	22.000 559	8	61
24 DN600	24.000 610	7	55

### NOTICE

- Victaulic Lubricant has full WRAS approval (Approval No. 0507514) and ANSI/NSF 61 approval.
- Canadian Customers – Canadian Workplace Hazardous Materials Information System (WHMIS) Requirements: Canadian customers shall contact Victaulic Canada for a Victaulic Lubricant SDS that meets Canadian WHMIS requirements.

## Dry Pipe Fire Protection System Notes

Victaulic Grade “E”, Type A FireLock gaskets are Factory Mutual (FM) Approved and Underwriters Laboratories, Inc. (UL) Listed for dry pipe fire protection systems. In freezers or systems subject to freezing temperatures, EPDM hardens as temperatures approach the lower temperature limitation of the gasket material.

To ensure a leak-tight seal, the outside surface of the mating components, between the groove and the mating component ends, shall be generally free from indentations, projections, weld seam anomalies, and roll marks. All oil, grease, loose paint, dirt, and cutting particles shall be removed.

In systems subject to both freezing temperatures and hydrostatic pressure tests, Victaulic recommends the following couplings:

- Style 005H FireLock™ Rigid Couplings with Grade “E”, Type A FireLock™ FlushSeal™ gaskets
- Style 108 FireLock™ IGS™ Installation-Ready™ Rigid Couplings
- Style 109 FireLock™ Installation-Ready™ Rigid Couplings
- Style 009N FireLock™ Installation-Ready™ Rigid Couplings

The center leg of the gasket reduces the potential for ice formation from residual water that can become trapped in the gasket cavity during hydrostatic pressure testing.

Grade “L” silicone gaskets are recommended in applications where pipe joint flexibility is preferable. At low temperatures, Grade “L” gaskets remain pliable and are able to seal on the pipe surface. In addition, Grade “L” gaskets adapt more readily to temperature swings that generate both linear and radial expansion/contraction, and they increase reliability of joints subject to movement (i.e. rack piping).

It is the system designer's, material specifier's, and/or the installing contractor's responsibility to select the gasket material grade that is suitable for the intended service.

Dry pipe fire protection systems are subject to supplemental lubrication requirements, as instructed in the applicable product installation section of this handbook (and in accordance with the “NOTICE” below).

## For Victaulic® FireLock™ Products with Pre-Lubricated Gaskets

### NOTICE

- **Certain Victaulic® FireLock™ products may be provided with pre-lubricated gaskets. Additional lubrication is not required for the initial installation of wet pipe systems that are installed at or continuously operating above 0°F/-18°C.**

**Supplemental lubrication is required only if any of the following conditions exist. Apply a thin coat of a compatible lubricant to the gasket sealing lips, as instructed in the applicable product installation section in this handbook. It is not necessary to remove the gasket from the housings to apply additional lubricant to the gasket sealing lips.**

- **If the installation or continuous operating temperature is below 0°F/-18°C**
- **If the gasket has been exposed to fluids prior to installation**
- **If the surface of the gasket has a dark black or shiny appearance**
- **If the gasket is being installed into a dry pipe system**
- **If the system will be subjected to air tests prior to being filled with water**
- **If the gasket was involved in a previous installation**
- **Lubricated gaskets will not enhance sealing capabilities on adverse mating component conditions. Mating component condition and preparation shall conform to the requirements listed in this handbook.**

# Spacing Requirements for Grooved Piping Systems

# RECOMMENDED MINIMUM PIPE SPACING

Since Victaulic grooved pipe couplings are externally-mounted housings that contain bolt pads, consideration shall be given to external dimensions beyond the pipe outside diameter to allow for ease of installation, inspection, and insulation. **Always allow enough spacing between adjacent piping and couplings to provide access for tightening hardware and for bolt pad inspection. Bolt pads can be positioned in any orientation to prevent interference with other system components. NOTE:** Allowance for insulation, when necessary, is not included in the following examples.

## Example with Bolt Pads Facing Each Other

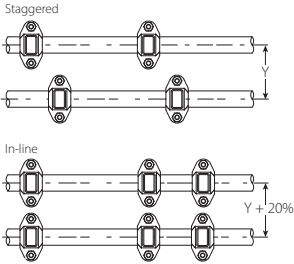

*Illustration is exaggerated for clarity*

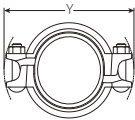

For the example above, where the bolt pads are facing each other and the couplings are staggered, the pipe centerline shall be spaced with the “Y” dimension of the coupling housings. **NOTE:** The “Y” dimension is the widest point across the coupling housings (bolt pad to bolt pad).

For the example above, where the bolt pads are facing each other and the couplings are in-line with each other, add an additional 20% to the “Y” dimension.

When installing grooved piping systems in confined areas, such as a pipe shaft, a tunnel, a narrow trench, or when joining riser pipe and dropping it through riser holes, consideration shall be given to the external clearance of the housings. This clearance shall be greater than the “Y” dimension (widest point). The necessary clearance will vary depending upon installation procedures, the proximity of other piping, and other factors.

## Example with Bolt Pads Facing Away from Each Other

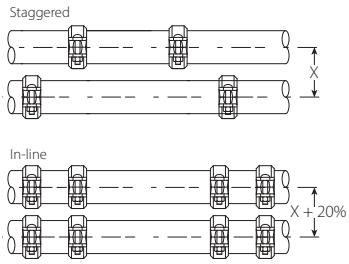

*Illustration is exaggerated for clarity*

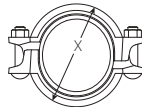

For the example above, where the bolt pads are facing away from each other and the couplings are staggered, the pipe centerline shall be spaced with the “X” dimension of the coupling housings. **NOTE:** The “X” dimension is the narrowest point across the coupling housings (crown to crown). For Installation-Ready™ Couplings, the “X” dimension is the pre-assembled condition.

For the example above, where the bolt pads are facing away from each other and the couplings are in-line with each other, add an additional 20% to the “X” dimension.

## NOTICE

- When installing Style 78/78A Snap-Joint™ Couplings, sufficient room shall be provided to allow clearance for the locking handle during assembly. Refer to the Style 78/78A installation instructions in this handbook for complete information.

# Rigid Systems

Piping Support

Pipe Support Spacing

Nominal Pipe-End Separation

# PIPING SUPPORT FOR RIGID SYSTEMS

## ⚠ WARNING

- The values in the following tables are not intended to be used as specifications for all installations, and they **DO NOT** apply where critical calculations are made or where there are concentrated loads between supports. The installer shall adhere to the design engineer's calculations for each project.
- **DO NOT** attach supports directly to couplings. Attach supports only to adjoining pipe and equipment.
- **DO NOT** use piping joined with Victaulic grooved pipe products as a lift point. **DO NOT** climb or hang on pipe joined with these products.
- Victaulic is not responsible for system design, nor does the Company assume any responsibility for systems that are designed improperly.
- Piping support/design shall comply with any local code requirements and shall be verified by a system designer/engineer.

Failure to follow these instructions could cause joint failure, resulting in death or serious personal injury and property damage.

Piping that is joined with grooved pipe couplings, like all other piping systems, requires support to carry the weight of piping, equipment, and fluid. The support or hanging method shall minimize stress on joints and allow pipeline movement, where required, along with other design requirements, such as drainage or venting. **NOTE:** Valves with unbalanced loads, particularly ones installed in horizontal pipelines within areas of high vibration, require support to resist external rotation.

## RIGID SYSTEMS – PIPE SUPPORT SPACING FOR STANDARD-WEIGHT CARBON STEEL PIPE

The following table lists the suggested maximum span between pipe supports for horizontal, straight runs of standard-weight carbon steel pipe (without concentrated loads) that carries water or similarly dense liquids.

Nominal Pipe Size inches/DN	Actual Pipe Outside Diameter inches/mm	Suggested Maximum Span Between Pipe Supports feet/meters					
		Water Service			Gas or Air Service		
		*	†	‡	*	†	‡
1 DN25	1.315 33.7	7 2.1	9 2.7	12 3.7	9 2.7	9 2.7	12 3.7
1 ¼ DN32	1.660 42.4	7 2.1	11 3.4	12 3.7	9 2.7	11 3.4	12 3.7
1 ½ DN40	1.900 48.3	7 2.1	12 3.7	15 4.6	9 2.7	13 4.0	15 4.6
2 DN50	2.375 60.3	10 3.1	13 4.0	15 4.6	13 4.0	15 4.6	15 4.6
3 DN80	3.500 88.9	12 3.7	16 4.9	15 4.6	15 4.6	17 5.2	15 4.6
4 DN100	4.500 114.3	14 4.3	17 5.2	15 4.6	17 5.2	21 6.4	15 4.6

\*Spacing based on ASME B31.1 Power Piping Code

†Spacing based on ASME B31.9 Building Services Piping Code

‡Spacing based on NFPA 13 Fire Sprinkler Systems

#Pipe support spacing for these sizes applies to AGS Rigid Couplings



# RIGID SYSTEMS – PIPE SUPPORT SPACING FOR STANDARD-WEIGHT CARBON STEEL PIPE (CONTINUED)

The following table lists the suggested maximum span between pipe supports for horizontal, straight runs of standard-weight carbon steel pipe (without concentrated loads) that carries water or similarly dense liquids.

Nominal Pipe Size inches/DN	Actual Pipe Outside Diameter inches/mm	Suggested Maximum Span Between Pipe Supports feet/meters					
		Water Service			Gas or Air Service		
		*	†	‡	*	†	‡
6 DN150	6.625 168.3	17 5.2	20 6.1	15 4.6	21 6.4	25 7.6	15 4.6
8 DN200	8.625 219.1	19 5.8	22 6.7	15 4.6	24 7.3	28 8.5	15 4.6
10 DN250	10.750 273.0	19 5.8	23 7.0	15 4.6	24 7.3	31 9.5	15 4.6
12 DN300	12.750 323.9	23 7.0	24 7.3	15 4.6	30 9.1	33 10.1	15 4.6
14# DN350	14.000 355.6	23 7.0	25 7.6	15 4.6	30 9.1	33 10.1	15 4.6
#	14.843 377.0	23 7.0	25 7.6	15 4.6	30 9.1	33 10.1	15 4.6
16# DN400	16.000 406.4	27 8.2	25 7.6	15 4.6	35 10.7	33 10.1	15 4.6
#	16.772 426.0	27 8.2	25 7.6	15 4.6	35 10.7	33 10.1	15 4.6
18# DN450	18.000 457.2	27 8.2	25 7.6	15 4.6	35 10.7	33 10.1	15 4.6
#	18.898 480.0	27 8.2	25 7.6	15 4.6	35 10.7	33 10.1	15 4.6
20# DN500	20.000 508.0	30 9.1	25 7.6	15 4.6	39 11.9	33 10.1	15 4.6
#	20.866 530.0	30 9.1	25 7.6	15 4.6	39 11.9	33 10.1	15 4.6
22# DN550	22.000 558.8	30 9.1	25 7.6	15 4.6	39 11.9	33 10.1	15 4.6
24# DN600	24.000 609.6	32 9.8	25 7.6	15 4.6	42 12.8	33 10.1	15 4.6
#	24.803 630.0	32 9.8	25 7.6	15 4.6	42 12.8	33 10.1	15 4.6

\*Spacing based on ASME B31.1 Power Piping Code

†Spacing based on ASME B31.9 Building Services Piping Code

‡Spacing based on NFPA 13 Fire Sprinkler Systems

#Pipe support spacing for these sizes applies to AGS Rigid Couplings



# RIGID SYSTEMS – PIPE SUPPORT SPACING FOR LIGHT-WALL STAINLESS STEEL PIPE

The following table lists the suggested maximum span between pipe supports for horizontal, straight runs of light-wall stainless steel pipe (without concentrated loads) that carries water or similarly dense liquids.

Nominal Pipe Size inches/DN	Actual Pipe Outside Diameter inches/mm	Wall Thickness		Suggested Maximum Span Between Pipe Supports
		inches/ mm	Schedule	feet/ meters
2 DN50	2.375 60.3	0.065 1.65	5S	9 2.7
		0.079 2.00	—	10 3.1
		0.109 2.77	10S	10 3.1
DN65	3.000 76.1	0.079 2.00	—	10 3.1
3 DN80	3.500 88.9	0.079 2.00	—	10 3.1
		0.083 2.11	5S	10 3.1
		0.120 3.05	10S	12 3.7
4 DN100	4.500 114.3	0.079 2.00	—	11 3.4
		0.083 2.11	5S	11 3.4
		0.120 3.05	10S	12 3.7
DN125	5.500 139.7	0.079 2.00	—	13 4.0
		0.102 2.60	—	13 4.0
		0.118 3.00	—	15 4.6
6 DN150	6.625 168.3	0.079 2.00	—	13 4.0
		0.102 2.60	—	13 4.0
		0.109 2.77	5S	13 4.0
		0.118 3.00	—	15 4.6
		0.134 3.40	10S	15 4.6

# RIGID SYSTEMS – PIPE SUPPORT SPACING FOR LIGHT-WALL STAINLESS STEEL PIPE (CONTINUED)

The following table lists the suggested maximum span between pipe supports for horizontal, straight runs of light-wall stainless steel pipe (without concentrated loads) that carries water or similarly dense liquids.

Nominal Pipe Size inches/DN	Actual Pipe Outside Diameter inches/mm	Wall Thickness		Suggested Maximum Span Between Pipe Supports
		inches/ mm	Schedule	feet/ meters
8 DN200	8.625 219.1	0.102 2.60	—	13 4.0
		0.109 2.77	5S	13 4.0
		0.118 3.00	—	15 4.6
		0.148 3.76	10S	15 4.6
10 DN250	10.750 273.0	0.118 3.00	—	15 4.6
		0.134 3.40	5S	15 4.6
		0.165 4.19	10S	16 4.9
12 DN300	12.750 323.9	0.118 3.00	—	15 4.6
		0.156 3.96	5S	16 4.9
		0.180 4.57	10S	17 5.2
14# DN350	14.000 355.6	0.188 4.78	10S	21 6.4
16# DN400	16.000 406.4	0.188 4.78	10S	22 6.7
18# DN450	18.000 457.2	0.188 4.78	10S	22 6.7
20# DN500	20.000 508.0	0.218 5.54	10S	24 7.3
22# DN550	22.000 558.8	0.218 5.54	10S	24 7.3
24# DN600	24.000 609.6	0.250 6.35	10S	25 7.6

#Pipe support spacing for these sizes applies to AGS Rigid Couplings

**NOTE:** Contact Victaulic for applications above 24 inch/DN600.



# NOMINAL PIPE-END SEPARATION FOR OGS RIGID, INSTALLATION-READY™ COUPLINGS

The nominal pipe-end separation dimensions, shown in the table below, are provided for system layout and installation purposes. The coupling styles listed are considered rigid connections and will not accommodate expansion or contraction of the piping system.

Nominal Pipe Size inches/DN	Actual Pipe Outside Diameter inches/mm	Nominal Pipe-End Separation inches/mm			
		Style 009N	Style 107V, 107N, 807N*	Style 108	Style 109
1 DN25	1.315 33.7	—	—	0.14 3.6	—
1 ¼ DN32	1.660 42.4	0.10 2.5	—	—	0.10 2.5
1 ½ DN40	1.900 48.3	0.10 2.5	—	—	0.10 2.5
2 – 3 DN50 – DN80	2.375 – 3.500 60.3 – 88.9	0.12 3.1	0.15 3.8	—	0.12 3.1
	4.250 108.0	0.17 4.3	0.15 3.8	—	—
4 DN100	4.500 114.3	0.17 4.3	0.15 3.8	—	0.17 4.3
	5.250 133.0	0.17 4.3	0.15 3.8	—	—
DN125	5.500 139.7	0.17 4.3	0.15 3.8	—	—
5	5.563 141.3	0.17 4.3	0.15 3.8	—	—
	6.250 159.0	0.17 4.3	0.15 3.8	—	—
	6.500 165.1	0.17 4.3	0.15 3.8	—	—
6 DN150	6.625 168.3	0.17 4.3	0.15 3.8	—	—
	8.500 216.0	0.17 4.3	—	—	—
#	8.515 216.3	—	0.20 5.1	—	—
8 DN200	8.625 219.1	0.17 4.3	0.20 5.1	—	—
#	10.528 267.4	—	0.20 5.1	—	—
10 DN250	10.750 273.0	0.25 6.4	0.20 5.1	—	—
#	12.539 318.5	—	0.20 5.1	—	—
12 DN300	12.750 323.9	0.25 6.4	0.20 5.1	—	—

\* The Style 107V and 807N are not available in all sizes listed in this table

# Applies to JIS metric pipe sizes 200A, 250A, and 300A, respectively (JIS Specification G 3452; G 3454).



# NOMINAL PIPE-END SEPARATION FOR ALL OTHER OGS RIGID COUPLINGS

The nominal pipe-end separation dimensions, shown in the table below, are provided for system layout and installation purposes. The coupling styles listed are considered rigid connections and will not accommodate expansion or contraction of the piping system.

Nominal Pipe Size inches/DN	Actual Pipe Outside Diameter inches/mm	Nominal Pipe-End Separation inches/mm				
		Style 005H	Style 07/L07	Style 89/889/ HP-70	Style HP-70ES	Style 489/ 489DX
1 DN25	1.315 33.7	—	0.05 1.2	—	—	—
1 ¼ DN32	1.660 42.4	0.05 1.2	0.05 1.2	—	—	—
1 ½ DN40	1.900 48.3	0.05 1.2	0.05 1.2	—	—	0.05 1.3
2 – 3 DN50 – DN80	2.375 – 3.500 60.3 – 88.9	0.07 1.7	0.07 1.7	0.14 3.6	0.19 4.8	0.05 1.3
	4.250 108.0	0.16 4.1	0.16 4.1	—	—	—
4 DN100	4.500 114.3	0.16 4.1	0.16 4.1	0.25 6.4	0.19 4.8	0.19 4.8
	5.250 133.0	0.16 4.1	0.16 4.1	—	—	—
DN125	5.500 139.7	0.16 4.1	0.16 4.1	0.25 6.4	—	0.25 6.4
5	5.563 141.3	0.16 4.1	0.16 4.1	0.25 6.4	—	0.25 6.4
	6.250 159.0	0.16 4.1	0.16 4.1	—	—	—
	6.500 165.1	0.16 4.1	0.16 4.1	0.25 6.4	—	0.25 6.4
6 DN150	6.625 168.3	0.16 4.1	0.16 4.1	0.25 6.4	0.27 6.7	0.25 6.4
#	8.515 216.3	—	0.19 4.8	0.25 6.4	—	0.25 6.4
8 DN200	8.625 219.1	0.19 4.8	0.19 4.8	0.25 6.4	0.27 6.7	0.25 6.4
#	10.528 267.4	—	0.13 3.3	0.25 6.4	—	0.25 6.4
10 DN250	10.750 273.0	—	0.13 3.3	0.25 6.4	0.28 7.1	0.25 6.4
#	12.539 318.5	—	0.13 3.3	0.25 6.4	—	0.25 6.4
12 DN300	12.750 323.9	—	0.13 3.3	0.25 6.4	0.28 7.1	0.25 6.4
14 – 16 DN350 – DN400	14.000 – 16.000 355.6 – 406.4	—	—	0.25 6.4	—	—

**NOTE:** Not all coupling styles are available in all sizes listed in this table  
 # Applies to JIS metric pipe sizes 200A, 250A, and 300A, respectively (JIS Specification G 3452; G 3454).

† Nominal pipe-end separation differs for Style 307 Transition Couplings. Refer to the I-300 Field Installation Handbook for details, which can be downloaded at [victaulic.com](http://victaulic.com).



# NOMINAL PIPE-END SEPARATION FOR AGS RIGID COUPLINGS ON DIRECT-GROOVED PIPE OR PIPE PREPARED WITH AGS *VIC-RINGS*

---

The nominal pipe-end separation dimensions, shown in the table below, are provided for system layout and installation purposes and apply only to pipe that is roll grooved to AGS specifications or prepared with AGS *Vic-Rings* for Style W07/LW07 and W89 AGS Rigid Couplings. Victaulic Style W07/LW07 and W89 AGS Rigid Couplings are considered rigid connections and will not accommodate expansion or contraction of the piping system.

<b>Nominal Pipe Size inches/DN</b>	<b>Coupling/ AGS <i>Vic-Ring</i> Size inches/mm</b>	<b>Nominal Pipe-End Separation inches/mm</b>
12 – 22 DN300 – DN550	14.000 – 24.000 355.6 – 609.6	0.25 6.4

# Flexible Systems

Piping Support  
Pipe Support Spacing  
Nominal Pipe-End Separation  
and Pipeline Deflection

# PIPING SUPPORT FOR FLEXIBLE SYSTEMS

## ⚠ WARNING

- The values in the following tables are not intended to be used as specifications for all installations, and they **DO NOT** apply where critical calculations are made or where there are concentrated loads between supports. The installer shall adhere to the design engineer's calculations for each project.
  - **DO NOT** attach supports directly to couplings. Attach supports only to adjoining pipe and equipment.
  - **DO NOT** use piping joined with Victaulic grooved pipe products as a lift point. **DO NOT** climb or hang on pipe joined with these products.
  - Victaulic is not responsible for system design, nor does the Company assume any responsibility for systems that are designed improperly.
  - Piping support/design shall comply with any local code requirements and shall be verified by a system designer/engineer.
- Failure to follow these instructions could cause joint failure, resulting in death or serious personal injury and property damage.

Piping that is joined with grooved pipe couplings, like all other piping systems, requires support to carry the weight of piping, equipment, and fluid. The support or hanging method shall minimize stress on joints and allow pipeline movement, where required, along with other design requirements, such as drainage or venting. The system designer shall consider the special requirements of flexible couplings while designing a support system. **NOTE:** Valves with unbalanced loads, particularly ones installed in horizontal pipelines within areas of high vibration, require support to resist external rotation.

## FLEXIBLE SYSTEMS – PIPE SUPPORT SPACING

The following table lists the suggested minimum number of pipe supports per standard-weight carbon steel pipe length for straight runs without concentrated loads, where full linear movement **IS REQUIRED**.

Nominal Pipe Size inches/DN	Actual Pipe Outside Diameter inches/mm	Pipe Length in feet/meters									
		7 2.1	10 3.0	12 3.7	15 4.6	20 6.1	22 6.7	25 7.6	30 9.1	35 10.7	40 12.2
<b>*Average Hangers Per Pipe Length – Evenly Spaced</b>											
¾ – 1 DN20 – DN25	1.050 – 1.315 26.9 – 33.7	1	2	2	2	3	3	4	4	5	6
1 ¼ – 2 DN32 – DN50	1.660 – 2.375 42.4 – 60.3	1	2	2	2	3	3	4	4	5	5
2 ½	2.875 73.0	1	1	2	2	2	2	2	3	4	4
DN65	3.000 76.1	1	1	2	2	2	2	2	3	4	4
3 – 4 DN80 – DN100	3.500 – 4.500 88.9 – 114.3	1	1	2	2	2	2	2	3	4	4
5 – 12	5.563 – 12.750 141.3 – 323.9	1	1	1	2	2	2	2	3	3	3
14 – 16# DN350 – DN400	14.000 – 16.000 355.6 – 406.4	1	1	1	2	2	2	2	3	3	3
18 – 24# DN450 – DN600	18.000 – 24.000 457.2 – 609.6	1	1	1	2	2	2	2	3	3	3

\*Pipe lengths shall not be left unsupported between any two couplings

**NOTE:** For project-specific requirements outside of the values provided, contact Victaulic.

# The values provided are for Style W77 AGS Flexible Couplings, installed with standard carbon steel hardware, at full operating pressure. For alternate hardware, operating pressures, or design spacing requirements, contact Victaulic.



# FLEXIBLE SYSTEMS – PIPE SUPPORT SPACING (CONTINUED)

The following table lists the suggested maximum span between pipe supports for standard-weight carbon steel pipe for straight runs without concentrated loads, where full linear movement **IS NOT REQUIRED**.

Nominal Pipe Size inches/DN	Actual Pipe Outside Diameter inches/mm	Suggested Maximum Span Between Pipe Supports feet/meters
¾ – 1 DN20 – DN25	1.050 – 1.315 26.9 – 33.7	8 2.4
1 ¼ – 2 DN32 – DN50	1.660 – 2.375 42.4 – 60.3	10 3.0
2 ½	2.875 73.0	12 3.7
DN65	3.000 76.1	12 3.7
3 – 4 DN80 – DN100	3.500 – 4.500 88.9 – 114.3	12 3.7
5	5.563 141.3	14 4.3
	6.000 152.4	14 4.3
	6.250 159.0	14 4.3
	6.500 165.1	14 4.3
6 – 8 DN150 – DN200	6.625 – 8.625 168.3 – 219.1	14 4.3
10 – 12 DN250 – DN300	10.750 – 12.750 273.0 – 323.9	16 4.9
14 – 16# DN350 – DN400	14.000 – 16.000 355.6 – 406.4	18 5.5
18 – 24# DN450 – DN600	18.000 – 24.000 457.2 – 609.6	20 6.1

**NOTE:** For project-specific requirements outside of the values provided, contact Victaulic.

# The values provided are for Style W77 AGS Flexible Couplings, installed with standard carbon steel hardware, at full operating pressure. For alternate hardware, operating pressures, or design spacing requirements, contact Victaulic.



# NOMINAL RANGE OF PIPE-END SEPARATION FOR STYLE 004N, 177N, AND 877N INSTALLATION-READY™ FLEXIBLE COUPLINGS

The nominal range of pipe-end separation dimensions, shown in the table below, are provided for system layout and installation purposes for both roll-grooved and cut-grooved pipe; this ensures that adequate clearances are included in piping system installation, relative to other piping system components or the building structure. These dimensions are particularly important when the system is free floating, or contains no thrust anchors, and the coupling joints are installed with the pipe ends butted against the center leg of the gasket. When installed in this condition, the joints will open to their full nominal pipe-end separation when the piping system is pressurized. This movement is cumulative and will be most significant in long runs of piping where multiple flexible couplings are installed with the pipe ends butted against the center leg of the gasket.

Nominal Pipe Size inches/DN	Actual Pipe Outside Diameter inches/mm	Nominal Range of Pipe-End Separation <sup>1</sup> inches/mm	
		Pipe Ends Butted Against Center Leg of Gasket <sup>2</sup>	Full Nominal Separation <sup>3</sup>
2 DN50	2.375 60.3	0.13	0.25
		3.3	6.4
2½	2.875 73.0	0.13	0.25
		3.3	6.4
DN65	3.000 76.1	0.13	0.25
		3.3	6.4
3 DN80	3.500 88.9	0.13	0.25
		3.3	6.4
4 DN100	4.250 108.0	0.18	0.38
		4.6	9.7
4 DN100	4.500 114.3	0.18	0.38
		4.6	9.7
DN125	5.250 133.0	0.18	0.38
		4.6	9.7
DN125	5.500 139.7	0.18	0.38
		4.6	9.7
5	5.563 141.3	0.18	0.38
		4.6	9.7
6 DN150	6.250 159.0	0.18	0.38
		4.6	9.7
6 DN150	6.500 165.1	0.18	0.38
		4.6	9.7
6 DN150	6.625 168.3	0.18	0.38
		4.6	9.7
8 DN200	8.625 219.1	0.18	0.38
		4.6	9.7

<sup>1</sup> Nominal range of pipe-end separation that may exist at the time of installation

<sup>2</sup> Nominal pipe-end separation when the pipe ends are butted against the center leg of the gasket, as illustrated in Figure 1

<sup>3</sup> Nominal pipe-end separation when the pipe ends are at full separation, as illustrated in Figure 2



Figure 1

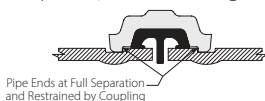

Figure 2

Illustrations are exaggerated for clarity

# LINEAR MOVEMENT AND ANGULAR DEFLECTION FOR STYLE 004N, 177N, AND 877N INSTALLATION-READY™ FLEXIBLE COUPLINGS

The following table provides linear movement and joint deflection capabilities of each coupling. Mechanical properties of the flexible coupling can be used in piping system design to accommodate curves, settlement of the building structure, seismic movement, or thermally-induced expansion or contraction of the piping system. Always refer to Victaulic publication 26.02 for additional design data.

Nominal Pipe Size inches/DN	Actual Pipe Outside Diameter inches/mm	Linear Movement Per Coupling <sup>4,7</sup> inches/mm	Joint Deflection <sup>7</sup>	
			Angle at Coupling <sup>5</sup> (Degrees Per Coupling)	Slope of Pipe <sup>6</sup> in/ft mm/m
2 DN50	2.375 60.3	0.09 2.3	2.17	0.46 38.1
2½	2.875 73.0	0.09 2.3	1.79	0.38 31.5
DN65	3.000 76.1	0.09 2.3	1.72	0.36 30.2
3 DN80	3.500 88.9	0.09 2.3	1.47	0.31 25.9
	4.250 108.0	0.18 4.6	2.43	0.51 42.6
4 DN100	4.500 114.3	0.18 4.6	2.29	0.48 40.3
	5.250 133.0	0.18 4.6	1.96	0.41 34.6
DN125	5.500 139.7	0.18 4.6	1.88	0.39 32.9
5	5.563 141.3	0.18 4.6	1.85	0.39 32.4
	6.250 159.0	0.18 4.6	1.65	0.35 28.9
	6.500 165.1	0.18 4.6	1.59	0.33 27.9
6 DN150	6.625 168.3	0.18 4.6	1.56	0.33 27.3
8 DN200	8.625 219.1	0.18 4.6	1.20	0.25 21.0

<sup>4</sup> Actual net linear movement available at each coupling, as illustrated in Figures 1 and 2

<sup>5</sup> Actual net deflection angle available at each coupling (listed in degrees), as illustrated in Figure 3

<sup>6</sup> Actual net deflection angle available at each coupling (listed as slope of pipe), as illustrated in Figure 4

<sup>7</sup> Net amount of linear movement or joint deflection available at the couplings. No further reduction, as detailed in Victaulic publication 26.02, is needed to allow for design and installation purposes.

**NOTE:** A coupling joint cannot provide full linear movement and full angular deflection simultaneously. If both linear movement and angular deflection are needed, sufficient couplings shall be installed for each purpose. Refer to Victaulic publication 26.02 for complete details.



**Figure 3 – Deflection Angle at Each Coupling Listed in Degrees**

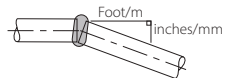

**Figure 4 – Deflection Angle at Each Coupling Listed as Slope of the Pipe**

*Illustrations are exaggerated for clarity*

# NOMINAL PIPE-END SEPARATION AND DEFLECTION FROM CENTERLINE FOR ALL OTHER OGS FLEXIBLE COUPLINGS

The nominal pipe-end separation and deflection values, shown in the table below, are the maximum nominal range of movement available at each joint for pipe that is roll grooved to OGS specifications. **Values for OGS cut-grooved pipe may be doubled.** These values are maximums. For design and installation purposes, these values may be reduced by 50% for ¾ – 3½-inch/DN20 – DN90 sizes and 25% for 4-inch/DN100 and larger sizes.

Nominal Pipe Size inches/DN	Actual Pipe Outside Diameter inches/mm	OGS ROLL-GROOVED PIPE		
		Nominal Pipe-End Separation inches/mm	Nominal Deflection from Centerline	
			Degrees Per Coupling	inches Per One foot of Pipe/ mm Per One meter of Pipe
¾ DN20	1.050 26.7	0 – 0.06 0 – 1.6	3.40	0.72 60
1 DN25	1.315 33.7	0 – 0.06 0 – 1.6	2.72	0.57 48
1 ¼ DN32	1.660 42.2	0 – 0.06 0 – 1.6	2.17	0.45 38
1 ½ DN40	1.900 48.3	0 – 0.06 0 – 1.6	1.93	0.40 33
2 DN50	2.375 60.3	0 – 0.06 0 – 1.6	1.52	0.32 26
	2.664 67.6	0 – 0.06 0 – 1.6	1.57	0.33 27
2 ½	2.875 73.0	0 – 0.06 0 – 1.6	1.25	0.26 22
DN65	3.000 76.1	0 – 0.06 0 – 1.6	1.20	0.26 22
3 DN80	3.500 88.9	0 – 0.06 0 – 1.6	1.03	0.22 18
3 ½ DN90	4.000 101.6	0 – 0.06 0 – 1.6	0.90	0.19 16
	4.250 108.0	0 – 0.13 0 – 3.2	1.68	0.35 29
4 DN100	4.500 114.3	0 – 0.13 0 – 3.2	1.60	0.34 28
	5.250 133.0	0 – 0.13 0 – 3.2	1.35	0.28 24
DN125	5.500 139.7	0 – 0.13 0 – 3.2	1.30	0.28 24
5	5.563 141.3	0 – 0.13 0 – 3.2	1.30	0.27 23
	6.250 159.0	0 – 0.13 0 – 3.2	1.15	0.24 20
	6.500 165.1	0 – 0.13 0 – 3.2	1.10	0.23 19
6 DN150	6.625 168.3	0 – 0.13 0 – 3.2	1.08	0.23 18

# NOMINAL PIPE-END SEPARATION AND DEFLECTION FROM CENTERLINE FOR ALL OTHER OGS FLEXIBLE COUPLINGS (CONTINUED)

The nominal pipe-end separation and deflection values, shown in the table below, are the maximum nominal range of movement available at each joint for pipe that is roll grooved to OGS specifications. **Values for OGS cut-grooved pipe may be doubled.** These values are maximums. For design and installation purposes, these values may be reduced by 50% for ¾ – 3½-inch/DN20 – DN90 sizes and 25% for 4-inch/DN100 and larger sizes.

Nominal Pipe Size inches/DN	Actual Pipe Outside Diameter inches/mm	OGS ROLL-GROOVED PIPE		
		Nominal Pipe-End Separation inches/mm	Nominal Deflection from Centerline	
			Degrees Per Coupling	inches Per One foot of Pipe/ mm Per One meter of Pipe
8* DN200	8.625 219.1	0 – 0.13 0 – 3.2	0.83	0.18 14
10* DN250	10.750 273.0	0 – 0.13 0 – 3.2	0.67	0.14 12
12* DN300	12.750 323.9	0 – 0.13 0 – 3.2	0.57	0.12 9
14# DN350	14.000 355.6	0 – 0.13 0 – 3.2	0.52	0.11 9
#	14.843 377.0	0 – 0.13 0 – 3.2	0.52	0.11 9
16# DN400	16.000 406.4	0 – 0.13 0 – 3.2	0.45	0.10 9
#	16.772 426.0	0 – 0.13 0 – 3.2	0.45	0.10 9
18# DN450	18.000 457.2	0 – 0.13 0 – 3.2	0.40	0.08 7
#	18.898 480.0	0 – 0.13 0 – 3.2	0.40	0.08 7
20# DN500	20.000 508.0	0 – 0.13 0 – 3.2	0.37	0.08 7
#	20.866 530.0	0 – 0.13 0 – 3.2	0.37	0.08 7
22# DN550	22.000 559.0	0 – 0.13 0 – 3.2	0.32	0.07 6
	22.835 580.0	0 – 0.13 0 – 3.2	0.32	0.07 6
24# DN600	24.000 609.6	0 – 0.13 0 – 3.2	0.30	0.07 6
#	24.803 630.0	0 – 0.13 0 – 3.2	0.30	0.07 6

\* Available in sizes to the JIS Standard. Refer to Victaulic publication 06.17, which can be downloaded at victaulic.com

# Victaulic offers the Advanced Groove System (AGS) line of products in these sizes. Refer to the two following pages in this handbook and Victaulic publication 20.03 for additional information.



# NOMINAL PIPE-END SEPARATION AND DEFLECTION FROM CENTERLINE FOR AGS FLEXIBLE COUPLINGS ON DIRECT-GROOVED PIPE

The nominal pipe-end separation and deflection from centerline dimensions, shown in the table below, are the maximum nominal range of movement available at each joint for pipe that is roll grooved to AGS specifications for Style W77 AGS Flexible Couplings.

Nominal Pipe Size inches/DN	Actual Pipe Outside Diameter inches/mm	Nominal Pipe-End Separation inches/mm		Nominal Deflection from Centerline	
		Minimum	Maximum	Degrees Per Coupling	in/ft mm/m
14 DN350	14.000 355.6	0.13 3.3	0.31 7.9	0.73	0.154 12.86
	14.843 377.0	0.13 3.3	0.31 7.9		0.69
16 DN400	16.000 406.4	0.13 3.3	0.31 7.9	0.64	0.135 11.25
	16.772 426.0	0.13 3.3	0.31 7.9		0.61
18 DN450	18.000 457.2	0.13 3.3	0.31 7.9	0.57	0.120 10.00
	18.898 480.0	0.13 3.3	0.31 7.9		0.54
20 DN500	20.000 508.0	0.13 3.3	0.31 7.9	0.51	0.108 9.00
	20.866 530.0	0.13 3.3	0.31 7.9		0.49
22 DN550	22.000 558.8	0.13 3.3	0.31 7.9	0.46	0.098 8.18
	24.000 609.6	0.13 3.3	0.31 7.9		0.42
24 DN600	24.000 609.6	0.13 3.3	0.31 7.9	0.42	0.090 7.50
	24.803 630.0	0.13 3.3	0.31 7.9		0.41

# NOMINAL PIPE-END SEPARATION AND DEFLECTION FROM CENTERLINE FOR AGS FLEXIBLE COUPLINGS ON PIPE PREPARED WITH AGS VIC-RINGS

The nominal pipe-end separation and deflection from centerline dimensions, shown in the table below, are the maximum nominal range of movement available at each joint for pipe that is prepared with AGS Vic-Rings for Style W77 AGS Flexible Couplings.

Nominal Pipe Size inches/DN	Coupling/ AGS Vic-Ring Size inches/mm	Nominal Pipe-End Separation inches/mm		Nominal Deflection from Centerline	
		Minimum	Maximum	Degrees Per Coupling	in/ft mm/m
12 DN300	14.000 355.6	0.13 3.3	0.31 7.9	0.73	0.154 12.86
14 DN350	16.000 406.4	0.13 3.3	0.31 7.9	0.64	0.135 11.25
16 DN400	18.000 457.2	0.13 3.3	0.31 7.9	0.57	0.120 10.00
18 DN450	20.000 508.0	0.13 3.3	0.31 7.9	0.51	0.108 9.00
20 DN500	22.000 558.8	0.13 3.3	0.31 7.9	0.46	0.098 8.18
22 DN550	24.000 609.6	0.13 3.3	0.31 7.9	0.42	0.090 7.50



# INSTALLATION TO ACHIEVE MAXIMUM LINEAR MOVEMENT CAPABILITIES OF FLEXIBLE SYSTEMS

To achieve maximum expansion/contraction allowance, pipe joints shall be installed with proper spacing between the pipe ends. The following is an overview of methods to accommodate expansion/contraction. For complete information, refer to Victaulic Section 26 publications, which can be downloaded at [victaulic.com](http://victaulic.com).

**For maximum expansion, pipe ends shall be at their maximum gap within the coupling.**

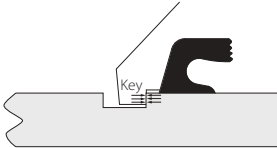

PROPER INSTALLATION FOR EXPANSION

*Illustration is exaggerated for clarity  
Pipe and groove are not shown to scale*

1. Vertical systems can be installed as the pipe is lowered by assembling the couplings and using the weight of the pipe to pull the pipe ends open.

For horizontal systems, select method 2a or 2b.

- 2a. Anchor the system at one end, and install the couplings and proper guides. Cap the system, pressurize it to fully open the pipe ends, then anchor the other end with the pipe ends fully gapped.
- 2b. Install the couplings. Use rigging equipment to pull the pipe for full end separation, then secure the pipe to maintain the opening.

**For maximum contraction, pipe ends shall be installed at the minimum pipe-end separation.**

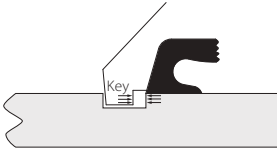

PROPER INSTALLATION FOR CONTRACTION

*Illustration is exaggerated for clarity  
Pipe and groove are not shown to scale*

1. In vertical systems, stack the pipe by using the weight to butt the pipe ends, then anchor the pipe to maintain the position.
2. In horizontal systems, install the pipe ends at the minimum pipe-end separation by using the coupling's "come-along" feature to adjust the pipe ends, then secure the pipe in position.

## For Expansion and Contraction

1. Alternate the above procedures in proportion to the need for expansion and contraction.

## Groove/Coupling Gapping

For expansion, visible gaps on either side of the coupling housings' key section (between the coupling housings' key section and the rear edge of the groove) can be used to verify proper installation of most couplings for maximum movement. These gaps are approximately equal to half the linear movement capability. Piping shall be secured to maintain the desired position.

For pipe contraction, virtually no gap should be visible between the coupling housings' key section and the rear edge of the groove. Piping shall be secured to maintain the desired position.

# Installation Overview

Impact Tool Usage Guidelines

Impact Tool Selection

Torque Wrench Selection

Required Tools and Supplies for Installation

Important Installation Information

Installation Inspection

System Testing

Maintenance After Installation

Insulation

Buried Applications

European ATEX Directive Notice

# IMPACT TOOL USAGE GUIDELINES

## NOTICE

- These guidelines are for couplings that require metal-to-metal bolt pad contact without a specified assembly torque.
- These guidelines are for non-lubricated, zinc-electroplated carbon steel hardware only.
- These guidelines are for products used on metallic piping only.
- **FOR ADVANCED GROOVE SYSTEM (AGS) PRODUCTS, REFER TO THE I-W100 FIELD INSTALLATION HANDBOOK FOR “IMPACT WRENCH USAGE,” “IMPACT WRENCH SELECTION,” AND “TORQUE WRENCH SELECTION” REQUIREMENTS. THE I-W100 CAN BE DOWNLOADED AT VICTAULIC.COM.**

Impact tools do not provide the installer with direct “wrench feel” to judge nut torque. Since some impact tools are capable of high output speed and torque, it is important to develop a familiarity with the impact tool to avoid over-shifting and/or over-torquing, which may damage or fracture the bolts or the coupling’s bolt pads during installation.

## WARNING

- **DO NOT** exceed the “Maximum Allowable Bolt Torque” values specified in the table on the following page for the applicable bolt/nut size.
- Failure to follow these instructions could cause joint failure, resulting in property damage, serious personal injury, or death.

**Assemble couplings per the applicable product installation instructions in this handbook.**

Continue to tighten the nut(s) until the visual inspection requirements, listed in the applicable product installation instructions in this handbook, are achieved. Visual inspection of each joint is required for verification of proper assembly. **For angled-bolt-pad couplings:** Equal and positive or neutral offsets shall be present at the angled bolt pads.

**During the installation process, the installation torque shall not exceed the “Maximum Allowable Bolt Torque” values specified in the table on the following page for the applicable bolt/nut size. Conditions that may result in over-shifting and/or excessive bolt torque include, but are not limited to, the following:**

- **Improperly-Sized Impact Tool** – Refer to the “Impact Tool Selection” section on page 60.
- **Uneven tightening of hardware** – For couplings containing two or more bolts, the nuts shall be tightened evenly by alternating sides until the visual inspection requirements for the particular coupling are achieved.
- **Over-shifting of the angled bolt pad** – Over-shifting of an angled bolt pad results in an offset that prevents metal-to-metal contact and equal and positive or neutral offset at the opposite angled bolt pad. This occurs when the hardware is not tightened evenly by alternating sides. Attempting to tighten the hardware on one side while the other side is over-shifted is improper installation and will result in bolt torque that exceeds the “Maximum Allowable Bolt Torque” values specified in the table on the following page. Continuing to tighten the hardware in an attempt to achieve metal-to-metal bolt pad contact at the other bolt pad will cause joint failure, resulting in property damage, serious personal injury, or death. For over-shifted couplings, the hardware for the angled bolt pads shall be loosened and then re-tightened to achieve equal and positive or neutral offsets at both angled bolt pads.

- **Out-of-specification grooved pipe end dimensions (particularly large and out-of-specification “C” diameters)** – If proper visual assembly is not achieved, remove the coupling and confirm that all grooved pipe end dimensions are within Victaulic specifications. If grooved pipe end dimensions are not within Victaulic specifications, rework the pipe ends by following all instructions in the applicable pipe preparation tool’s operating and maintenance manual.
- **Continued tightening of nut(s) after the visual inspection requirements are achieved** – DO NOT continue to tighten the nut(s) after the visual inspection requirements are achieved. Continuing to tighten the hardware after proper visual inspection requirements are achieved will cause joint failure, resulting in property damage, serious personal injury, or death. In addition, continued tightening may cause excessive stresses that compromise the long-term integrity of the bolts and may cause joint failure, resulting in property damage, serious personal injury, or death. Additional bolt torque will not provide a better installation; bolt torque that exceeds the “Maximum Allowable Bolt Torque” values specified in the table on this page could damage or fracture the bolts and/or the coupling’s bolt pads during installation.
- **Pinched gasket** – A pinched gasket could result in the inability to achieve proper visual inspection requirements. The coupling shall be disassembled and inspected to verify that the gasket is not pinched. If the gasket is pinched, a new coupling assembly shall be used.
- **Coupling was not assembled per the applicable Victaulic installation instructions** – Adherence to installation instructions will help to avoid the conditions covered in this section.

**If you suspect that any hardware has been over-torqued, the entire coupling assembly shall be replaced immediately (as indicated by a bend in the bolt, bulging of the nut at the bolt pad interface, or damage to the bolt pad, etc.).**

#### Maximum Allowable Bolt Torque

Bolt/Nut Size		Maximum Allowable Bolt Torque*
inches	Metric	
5/16	–	15 ft-lbs 20 N•m
3/8 †	M10	55 ft-lbs 75 N•m
7/16 ‡	M11	100 ft-lbs 136 N•m
1/2	M12	135 ft-lbs 183 N•m

Bolt/Nut Size		Maximum Allowable Bolt Torque*
inches	Metric	
5/8	M16	235 ft-lbs 319 N•m
3/4 §	M20	425 ft-lbs 576 N•m
7/8 §	M22	675 ft-lbs 915 N•m
1	M24	875 ft-lbs 1186 N•m

\*Maximum allowable bolt torque values have been derived from actual test data

† **For 009N, 101, 102, 103, 104, 108, 109, and 118 FireLock™ Products Only:**

For LPCB and VdS Certification for 3/8"/M10 bolts, the bolt torque is 55 ft-lbs/75 N•m.

‡ **For 009N, 101, 102, 103, 104, and 109 FireLock™ Products Only:**

For LPCB and VdS Certification for 7/16"/M11 bolts, the bolt torque is 75 ft-lbs/102 N•m.

§ **Style 107V QuickVic™ Installation-Ready™ Rigid Couplings Only:**

These bolt sizes are pre-lubricated. Reference the table on page 97 for the maximum allowable bolt torques for these bolt/nut sizes.

*Continued on the following page*



## IMPACT TOOL SELECTION

---

Appropriate selection of an impact tool is required to ensure proper installation in accordance with the applicable coupling installation instructions. Improper impact tool selection could cause coupling mis-assembly and damage, resulting in property damage, serious personal injury, or death.

To determine the suitability of an impact tool, perform trial installation assemblies with a standard socket wrench or a torque wrench. These trial coupling assemblies shall meet the visual installation requirements for the particular coupling. After visual installation requirements are achieved, measure the torque applied to each nut with a torque wrench. Using the torque value measured, select an impact tool with a torque output or torque output setting that conforms to the measured value but does not exceed the "Maximum Allowable Bolt Torque" values specified in the table on the previous page.

### **Selection of an Impact Tool:**

**Impact Tools with Single Output Torque** – Selection of an impact tool with an output torque considerably higher than the required installation torque could result in hardware and/or coupling damage due to the possibility of hardware over-torque. Under no circumstances shall an impact tool be selected for use that has a torque output setting that exceeds the "Maximum Allowable Bolt Torque" values specified in the table on the previous page.

**Impact Tools with Multiple Output Torque Settings** – If an impact tool with multiple output torque settings is selected, the impact tool shall have at least one torque setting that satisfies the above requirements for an "Impact Tool with Single Output Torque."

Use of impact tools with excessive output torques creates installation difficulties for the installer due to the tool's unmanageable rotational speed and power. Using the same method above, periodically check nut torque on coupling assemblies throughout the system installation process.

For safe and proper use of impact tools, always refer to the impact tool manufacturer's operating instructions. In addition, verify that proper impact grade sockets are being used for coupling installation.

### **⚠ WARNING**

**Failure to follow instructions for tightening hardware could result in:**

- Bolt damage or fracture
- Damaged or broken bolt pads or fractures to housings
- Joint leakage and property damage
- A negative impact on system integrity
- Personal injury or death

## TORQUE WRENCH SELECTION

---

For products that have a required assembly torque, a torque wrench shall be selected with a range that is in accordance with the required bolt torque specified in the respective instructions in this handbook. The selected torque wrench shall be certified and calibrated in accordance with a recognized national standard. Always refer to the instructions supplied with the torque wrench for proper usage and selection of desired torque value.

# REQUIRED TOOLS AND SUPPLIES FOR INSTALLATION

---

Confirm that the correct quantity of applicable hardware and housings has been supplied for the connection being made. Inspect gasket size, gasket material grade, and hardware size to verify suitability for the intended service.

The following tools and supplies are required for all coupling and flange adapter installations.

- PPE Required by Jobsite (hardhat, leather gloves, safety glasses, steel-toe shoes)
- Victaulic Lubricant or Other Compatible Lubricant
- Appropriate Bolt Thread Lubricant (Where Noted in Specific Product Instructions)
- Brushes for Lubrication (Where Noted in Specific Product Instructions)
- Deep-Well Sockets
- Long-Handle Ratchet Wrench or Impact Tool
- Torque Wrench (Where Noted in Specific Product Instructions)
- Towels
- Water Bottle (for misting lubricated gaskets in hot environments, as needed)

# IMPORTANT INSTALLATION INFORMATION

## ! WARNING



- Always verify that the piping system has been completely depressurized and drained immediately prior to installation, removal, adjustment, or maintenance of any Victaulic products.
- Confirm that any equipment, branch lines, or sections of piping that may have been isolated for/ during testing or due to valve closures/positioning are identified, depressurized, and drained immediately prior to installation, removal, adjustment, or maintenance of any Victaulic products.

Failure to follow these instructions could result in death or serious personal injury and property damage.

- Always reference the operating and maintenance manual for the applicable pipe preparation tool and the specific product instructions in this handbook for complete safety and operating/installation requirements.
- **Always allow enough spacing between adjacent piping and couplings to provide access for tightening hardware and for bolt pad inspection.**
- **When joining pipe of the same size but different wall thicknesses/schedules, the joint rating will be based on the pressure rating of the thinner-wall pipe.**
- Always verify that the correct groove profile is being used.
- The mating components' outside diameter ("OD"), groove dimensions, and maximum allowable flare diameter shall be within the tolerances published in current Victaulic groove specifications.
- Always check gasket material grade to verify that it is suitable for the intended service.
- DO NOT use rigid, angled-bolt-pad couplings with PVC plastic pipe.
- When wafer or lug-type valves are used adjoining a Victaulic fitting, verify the disc dimensions to ensure that there is proper clearance.
- Couplings that contain a tongue-and-recess feature shall be mated properly, tongue-to-recess.
- When an assembly torque value is specified for coupling installation, the torque **SHALL** be applied to the nuts to achieve proper installation. Torque beyond the specified values will not improve sealing. Exceeding the specified torque by more than 10% may cause product damage, resulting in joint failure and property damage.
- Deep-well sockets are required for proper installation of Advanced Groove System **405**, Installation-Ready™, FireLock EZ™, and QuickVic™ couplings and are recommended for all other couplings. Deep-well sockets provide full nut engagement during tightening.
- During installation, if the coupling does not appear to be seated in the grooves properly, the hardware for the coupling shall be loosened and the installation process shall be attempted again. If installation difficulties persist, refer to the "Installation Inspection" section on the following pages.
- Verify that the oval neck of each bolt seats proper in the bolt hole, as shown below.



**GOOD BOLT ENGAGEMENT**  
(OVAL NECK OF EACH BOLT IS SEATED PROPERLY IN THE BOLT HOLE)



**BAD BOLT ENGAGEMENT**  
(OVAL NECK OF BOLT IS NOT SEATED PROPERLY IN THE BOLT HOLE)

# INSTALLATION INSPECTION

## ⚠ WARNING

- Always inspect each joint to verify proper product installation.
- Undersized or oversized pipes/fittings, shallow grooves, eccentric grooves, bolt pad gaps, etc. are unacceptable. Any of these conditions shall be corrected before attempting to pressurize the system.
- DO NOT impact/hit the coupling to force it to seat in the grooves.

Failure to follow these instructions could cause joint failure, resulting in death or serious personal injury and property damage.

### Installations with Undersized Pipe/Fittings – NOT ACCEPTABLE

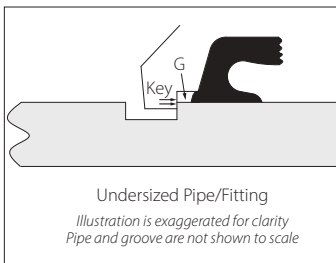

When the OD of the pipe or fitting is below the minimum tolerance, engagement of the housings' key sections is lowered considerably. THIS RESULTS IN REDUCED WORKING PRESSURE FOR THE JOINT.

Additionally, there is little or no added compression of the gasket. The increased gap "G" between the pipe and the housing may also result in gasket extrusion. These factors can contribute to reduced gasket life, joint leakage, and property damage.

When the OD of the pipe or fitting is below the minimum tolerance, discard the fitting or section of pipe and use a new fitting or section of pipe that conforms to Victaulic specifications.

### Installations with Oversized Pipe/Fittings – NOT ACCEPTABLE

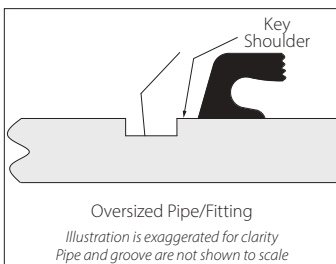

When the OD of the pipe or fitting exceeds the maximum tolerance, engagement of the housings' key sections is increased to the point that the shoulder can grip onto the pipe and can result in reduced linear or angular movement. Under these conditions, metal-to-metal bolt pad contact may not be achieved, the gasket may become extruded, the working pressure of the joint may be reduced, and gasket life may be reduced.

When the OD of the pipe or fitting exceeds the maximum tolerance, discard the fitting or section of pipe and use a new fitting or section of pipe that conforms to Victaulic specifications.

### Installations on Pipe with Shallow Grooves – NOT ACCEPTABLE

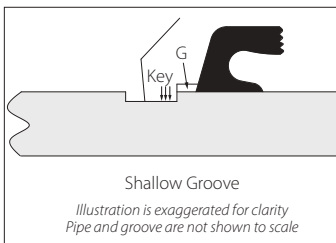

When the groove diameter exceeds the maximum tolerance, a shallow groove will occur. A groove that is shallow (not deep enough) will have the same effect as the conditions described in the "Installations with Undersized Pipes/Fittings" section above. In addition, this condition may prevent metal-to-metal bolt pad contact from being achieved, resulting in joint failure and property damage.

If the groove is shallow (not deep enough), re-groove the pipe to Victaulic specifications by following the instructions in the applicable pipe preparation tool's operating and maintenance manual.

## Installations on Pipe with Deep Grooves – NOT ACCEPTABLE

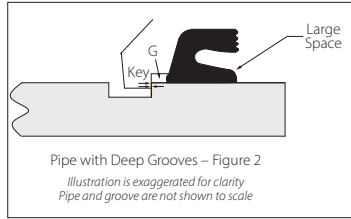
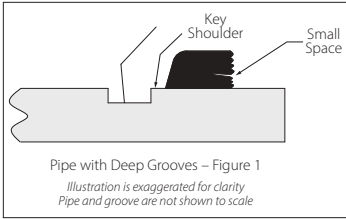

When the groove diameter is below the minimum tolerance, a deep groove will occur. A groove that is too deep will allow the coupling to shift so that one housing will have full key engagement (Figure 1 above) and the other housing will have significantly reduced key engagement (Figure 2 above). This will have the same effect as the conditions described in the “Installations with Undersized Pipe/Fittings” section. Additionally, roll grooving pipe to an undersized dimension may overstress and weaken the pipe wall. Cut grooving pipe to an undersized dimension will result in insufficient wall thickness under the groove. If the groove is too deep, discard that section of pipe and groove another section to Victaulic specifications.

## Installations on Pipe with Eccentric Grooves – NOT ACCEPTABLE

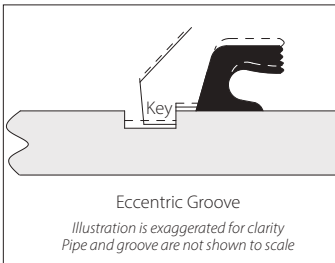

An eccentric groove is a groove that is too shallow on one side and too deep on the other side. Generally, eccentric grooves occur when out-of-round pipe is grooved with a stationary tool bit, such as the case with a lathe, and they can also occur when roll grooving pipe with large wall thickness variations. Eccentric grooves may lead to a combination of the conditions outlined in the “Installations with Oversized Pipes/Fittings” section and the “Installations on Pipes with Shallow Grooves” section.

## Bolt Pad Gaps – NOT ACCEPTABLE

Always refer to the instructions in this handbook for the applicable product. Unless stated otherwise in the specific product’s installation instructions, Victaulic grooved pipe couplings **SHALL** be assembled with metal-to-metal bolt pad contact. For couplings with an assembly torque requirement, any specified torque values shall be achieved at each set of hardware; however, metal-to-metal bolt pad contact may not occur when the torque requirement is reached (this condition will be noted in the applicable product’s installation instructions). Any questions regarding an installation should be directed to Victaulic (scan the QR code on the back cover of this handbook for a listing of locations and contact information).

If the bolt pads are not in metal-to-metal contact:

- Verify that the hardware has been tightened evenly by alternating bolt pad locations, in accordance with the instructions in this handbook for the applicable product.
- Verify that the coupling keys are engaged with the grooves. Coupling keys shall not rest on the outside surface of the pipe.
- Verify that the gasket has not fallen/shifted into the grooves in the pipe.
- Verify that the gasket is not pinched at the bolt pad locations. Pinched gaskets shall be replaced immediately.
- Verify that oversized pipe or fittings were not used (reference the “Installation with Oversized Pipe/Fittings” section on the previous page).
- Verify that the grooves conform to Victaulic specifications (reference the “Installations on Pipe with Shallow Grooves, Installations on Pipe with Deep Grooves, and Installations on Pipe with Eccentric Grooves” sections above and on the previous page).

# SYSTEM TESTING

---

System testing shall be in accordance with any jobsite requirements and any local or national codes and requirements.

Always re-inspect joints before and after the field test to identify points of improper installation. Look for gaps at the bolt pads and/or keys that ride up on the shoulders. If any of these conditions exist, depressurize the system and replace any questionable joints.

## NOTICE

- **A SUCCESSFUL INITIAL SYSTEM PRESSURE TEST DOES NOT VALIDATE PROPER INSTALLATION AND IS NOT A GUARANTEE OF LONG-TERM PERFORMANCE.**
- **Victaulic will not assume any liability for pipe joint leakage or failure that may result from an installer's failure to follow installation instructions.**
- **As with any pipe joining method, success is determined by close attention to details. Careful adherence to the instructions found in this handbook is critical to ensure maximum system reliability.**

# MAINTENANCE AFTER INSTALLATION

---

When installed correctly in accordance with the instructions in this handbook, Victaulic grooved pipe products do not require maintenance after installation. Maintenance activities for certain valves will be specified within their respective "Installation and Maintenance" manual, which is provided with the valve.

## WARNING

- **Any replacement parts, including coupling hardware, shall be authorized/supplied by Victaulic.**

**Failure to follow this instruction could cause joint failure, resulting in death or serious personal injury and property damage.**

# INSULATION

---

Before installing insulation, verify that the piping system to be covered has been properly installed, tested, and approved by the engineer of record. Contact Victaulic for additional information regarding insulation products.

# BURIED APPLICATIONS

---

When specifying products in this handbook for buried applications, the effects of soil conditions on buried systems shall be incorporated into system design to prevent corrosion. Reference the applicable product publication(s) for details regarding the materials and finishes available for assembly hardware. The system designer shall evaluate the effect of chemical composition and pH level on the assembly hardware to confirm that the materials and finishes used will resist corrosion and will be acceptable for the intended service. Special coatings and/or cathodic protection may be applied to ensure system longevity. Request Victaulic publication 26.15, "Grooved Piping Systems in Buried Applications" for additional information.

## **FOR BURIED APPLICATIONS, THE SYSTEM DESIGNER OR THEIR REPRESENTATIVE IS RESPONSIBLE FOR IDENTIFYING/SPECIFYING THE FOLLOWING:**

- Appropriate pipe wall thickness for the application
- Hardware material requirements
- Maximum allowable working pressure
- Maximum allowable test pressure
- Soil backfill type, modulus, and density
- Distance of the piping system from structures (maximum shear loads)
- Effects of live loads on the piping system
- Effects of earth loads on pipe ovality

The trench bed shall be prepared to ensure that continuous support is provided under the pipe and couplings. Haunching material, which is found in the area between the bedding and the underside of the pipe, shall be worked in and compacted before continuing backfill. Haunching shall have no voids, and the backfill material shall not be contaminated with debris or other foreign materials that could damage the pipe or cause loss of support. **All backfill shall be consistent and meet application-site specifications. Protection shall be implemented to prevent aggregate from entering the grooves adjacent to the coupling keys.**

# EUROPEAN ATEX DIRECTIVE

---

For applications involving compliance with the European ATEX Directive, the following "NOTICE" applies.

## **NOTICE**

### **Stainless Steel Rigid Couplings Installed with Stainless Steel Pipe and Fittings**

### **Galvanized Rigid Couplings Installed with Galvanized and Uncoated Steel Pipe and Galvanized Fittings**

- When used in applications where the atmosphere is potentially combustible, Victaulic's product installation instructions shall be strictly followed to ensure that the couplings are engaged properly in the pipe grooves and that the housings are assembled with full metal-to-metal bolt pad contact.
- Electrical conductivity shall be checked routinely (electrostatic resistance not to exceed  $10^6$  Ohm when measured across a properly installed pipe-to-pipe or pipe-to-fitting joint).

# **One-Bolt, Installation-Ready™ Couplings for Grooved-End Mating Components**

**Instructions for Initial Installation**

**Instructions for Reassembly**

# PREPARATORY STEPS FOR INSTALLATION OF COUPLINGS FEATURED IN THIS SECTION

## ! WARNING



- Read and understand all instructions before attempting to install any Victaulic products.
- Always verify that the piping system has been completely depressurized and drained immediately prior to installation, removal, adjustment, or maintenance of any Victaulic products.
- Confirm that any equipment, branch lines, or sections of piping that may have been isolated for/during testing or due to valve closures/positioning are identified, depressurized, and drained immediately prior to installation, removal, adjustment, or maintenance of any Victaulic products.
- These installation instructions are intended for an experienced, trained installer. The installer shall understand the use of this product and why it was specified for the particular application.
- The installer shall understand common industry safety standards and potential consequences of improper product installation.
- Wear safety glasses, hardhat, and foot protection.

Failure to follow these instructions could result in death or serious personal injury and property damage.

## ! WARNING

- Style 108 and 118 Couplings shall be used **ONLY** with mating components that are prepared to Victaulic IGS proprietary groove specifications.
- Style 109 Couplings shall be used **ONLY** with mating components that are prepared to Victaulic OGS groove specifications.
- **DO NOT** attempt to install these products on mating components that are prepared to any groove specification other than what is specified in their respective installation instructions.

Failure to follow these instructions could cause joint failure, resulting in death or serious personal injury and property damage.

## Instructions for the Initial Installation of Style 108, 109, and 118 Couplings

### NOTICE

- The photos in this section show installation of a Style 109 Coupling; however, the same steps apply to installation of all other couplings listed above.

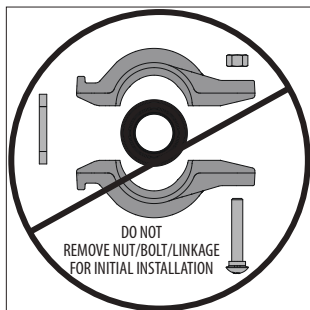

- 1. DO NOT DISASSEMBLE THE COUPLING:** Installation-Ready™ Couplings are designed so that the installer does not need to remove the nut, bolt, or linkage for initial installation. This facilitates installation by allowing the installer to directly insert the grooved end of mating components into the coupling.

**2. CHECK MATING COMPONENT ENDS:** The outside surface of the mating components, between the groove and the mating component ends, shall be generally free from indentations, projections, weld seam anomalies, and roll marks to ensure a leak-tight seal. All oil, grease, loose paint, dirt, and cutting particles shall be removed. Always verify that the correct groove profile is being used.

**For Style 108 and 118 Couplings:** The mating components' outside diameter ("OD"), groove dimensions, and maximum allowable flare diameter shall be within the tolerances listed in this handbook for Victaulic IGS groove specifications.

**For Style 109 Couplings:** The mating components' outside diameter ("OD"), groove dimensions, and maximum allowable flare diameter shall be within the tolerances listed in this handbook for Victaulic OGS groove specifications.

## NOTICE

- For Victaulic® FireLock™ products that are provided with pre-lubricated gaskets, refer to the "NOTICE" and the "Dry Pipe Fire Protection Systems Notes" section on page 36 for additional information.

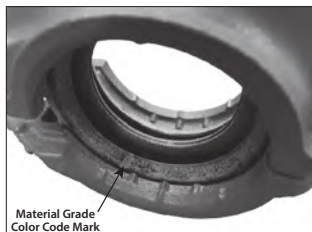

**3. CHECK GASKET:** Check the gasket to verify that it is suitable for the intended service. The color code identifies the material grade. Refer to page 32 for the "Gasket Color Code Reference" table and the "NOTICE" on page 36 for important gasket information. For complete compatibility information, reference Victaulic publications 05.01 and GSG-100, which can be downloaded at [victaulic.com](http://victaulic.com).

## ! CAUTION

- If any conditions listed in the "NOTICE" on page 36 are met, a thin coat of a compatible lubricant shall be applied only to the gasket sealing lips to help prevent the gasket from pinching, rolling, or tearing during installation.
- DO NOT use excessive lubricant on the gasket sealing lips.

Failure to use a compatible lubricant may cause gasket damage, resulting in joint leakage and property damage.



**3a.** If any conditions listed in the "NOTICE" on page 36 are met, apply a thin coat of a compatible lubricant only to the gasket sealing lips. Refer to the "Lubricant Compatibility for Gaskets" table on page 34.

Style 108 - FireLock™ IGS™ Installation-Ready™ Rigid Coupling

Style 109 - FireLock™ Installation-Ready™ Rigid Coupling

## ! WARNING



- Read and understand all instructions before attempting to install any Victaulic products.
- Always verify that the piping system has been completely depressurized and drained immediately prior to installation, removal, adjustment, or maintenance of any Victaulic products.
- Confirm that any equipment, branch lines, or sections of piping that may have been isolated for/during testing or due to valve closures/positioning are identified, depressurized, and drained immediately prior to installation, removal, adjustment, or maintenance of any Victaulic products.
- Wear safety glasses, hardhat, and foot protection.
- Style 108 and 109 Victaulic® FireLock™ Installation-Ready™ Rigid Couplings shall be used only in fire protection systems that are designed and installed in accordance with current, applicable National Fire Protection Association (NFPA 13, 13D, 13R, etc.) standards, or equivalent standards, and in accordance with applicable building and fire codes. These standards and codes contain important information regarding protection of systems from freezing temperatures, corrosion, mechanical damage, etc.
- These installation instructions are intended for an experienced, trained installer. The installer shall understand the use of this product and why it was specified for the particular application.
- The installer shall understand common industry safety standards and potential consequences of improper product installation.

Failure to follow installation requirements and local and national codes and standards could compromise system integrity or cause system failure, resulting in death or serious personal injury and property damage.

### 1. Follow all instructions in the “Preparatory Steps” section on pages 68 – 69.

IGS Groove Profile for Style 108 Couplings



OGS Groove Profile for Style 109 Couplings



*Pipe and grooves are not shown to scale*

Style 108 Couplings shall be used **ONLY** with mating components that are prepared to Victaulic IGS proprietary groove specifications. **DO NOT** attempt to install this coupling on mating components that are prepared to any other groove specification. **DO NOT** use the Style 108 Coupling for sprinkler-piping-to-sprinkler connections. For sprinkler-piping-to-sprinkler connections, the Style V9 shall be used.

Style 109 Couplings shall be used **ONLY** with mating components that are prepared to Victaulic OGS groove specifications. **DO NOT** attempt to install this coupling on mating components that are prepared to any other groove specification.



ONE-BOLT, INSTALLATION-READY™ COUPLINGS  
FOR GROOVED-END MATING COMPONENTS  
INSTALLATION INSTRUCTIONS REV\_H

## NOTICE

- The photos in this section show installation of a Style 109 Coupling; however, the same steps apply to installation of a Style 108 Coupling.

## ! WARNING



- Never leave a Style 108 or 109 Coupling partially assembled on mating component ends. ALWAYS TIGHTEN THE HARDWARE IMMEDIATELY, IN ACCORDANCE WITH THESE INSTRUCTIONS. A partially assembled coupling poses a drop or fall hazard during installation and a burst hazard during testing.
- Keep hands away from the mating component ends and the openings of the coupling when attempting to insert grooved mating component ends into the coupling.
- Keep hands away from coupling openings during tightening. Failure to follow these instructions could result in death or serious personal injury and property damage.



**4. ASSEMBLE JOINT:** Assemble the joint by inserting the grooved end of a mating component into each opening of the coupling. The grooved mating component ends shall be inserted into the coupling until contact with the center leg of the gasket occurs. A visual check is required to verify that the coupling keys align with the groove in each mating component and that the gasket is seated properly. **NOTE:** Prior to tightening the nut, the coupling may be rotated to verify that the gasket is seated properly on the mating component ends and within the coupling housings.

### IMPORTANT INFORMATION FOR USE OF STYLE 108 AND 109 COUPLINGS WITH END CAPS AND FITTINGS:

## ! WARNING

- Always read and follow the “Victaulic End Cap Installation Safety Instructions” section in this handbook.

Failure to follow the “Victaulic End Cap Installation Safety Instructions” section could result in death or serious personal injury and property damage.

- When assembling Style 108 and 109 Couplings onto end caps, take additional time to inspect and verify that the end cap is seated fully against the center leg of the gasket.
- For Style 108 Couplings, use only Victaulic® No. 146 FireLock™ IGS™ End Caps containing the “PG” marking.
- For Style 109 Couplings, use only Victaulic® FireLock™ No. 006 End Caps containing the “EZ” marking on the inside face or Victaulic End Caps containing the “QV” or “EZ QV” marking on the inside face.
- Always confirm that any equipment, branch lines, or sections of piping that may have been isolated for/during testing or due to valve closures/positioning are identified, depressurized, and drained immediately prior to working with an end cap.
- Victaulic recommends the use of Victaulic fittings with Style 108 and 109 Couplings.

## ! WARNING

- The nut shall be tightened until metal-to-metal contact occurs at the bolt pads, as indicated in steps 5 and 6a or 6b.
- **DO NOT** continue to tighten the nut after the visual, metal-to-metal bolt pad inspection requirement is achieved.

Failure to follow instructions for tightening hardware could result in:

- Damage to the assembled joint (damaged or broken bolt pads or fractures to housings)
- Bolt damage or fracture
- Joint leakage and property damage
- A negative impact on system integrity
- Personal injury or death

## NOTICE

- An impact tool or standard socket wrench with a deep-well socket can be used to bring the bolt pads into metal-to-metal contact.
- Refer to the “Impact Tool Usage Guidelines” and “Impact Tool Selection” sections in this handbook.



**5. TIGHTEN NUT:** Using an impact tool or a standard socket wrench with a deep-well socket, tighten the nut.

**For Style 108 Couplings:** Tighten the nut until metal-to-metal contact occurs at the bolt pads.

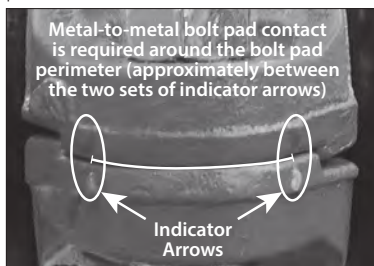

**For Style 109 Couplings:** Tighten the nut until metal-to-metal contact occurs around the bolt pad perimeter (approximately between the two sets of indicator arrows that are cast into the housings, as shown to the left).

**For Style 108 and 109 Couplings:** Verify that the oval neck of the bolt seats properly in the bolt hole. **DO NOT** continue to tighten the nut after the visual, metal-to-metal bolt pad inspection requirement is achieved. **If you suspect that any hardware has been over-tightened (as indicated by a bend in the bolt, bulging of the nut at the bolt pad interface, or damage to the bolt pad, etc.), the entire coupling assembly shall be replaced immediately.** Refer to the “Impact Tool Usage Guidelines” and “Impact Tool Selection” sections in this handbook, along with the “Helpful Information” table on the following page.

OV  
AL NECK  
OF BOLT  
SEATED  
PROPERLY

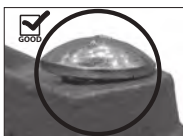

OV  
AL NECK  
OF BOLT  
NOT  
SEATED  
PROPERLY



## Helpful Information

Nominal Pipe Size inches/DN	Actual Pipe Outside Diameter inches/mm	Nut Size inches/Metric	Deep-Well Socket Size inches/mm	Maximum Allowable Bolt Torque*
1 – 2 DN25 – DN50	1.315 – 2.375 33.7 – 60.3	$\frac{3}{8}$ M10	$\frac{1}{16}$ 17	55 ft-lbs 75 N•m
2½	2.875 73.0	$\frac{3}{8}$ M10	$\frac{1}{16}$ 17	55 ft-lbs 75 N•m
DN65	3.000 76.1	$\frac{7}{16}$ M11	$\frac{3}{4}$ 19	100 ft-lbs 136 N•m
3 – 4 DN80 – DN100	3.500 – 4.500 88.9 – 114.3	$\frac{7}{16}$ M11	$\frac{3}{4}$ 19	100 ft-lbs 136 N•m

\*Maximum allowable bolt torque values have been derived from actual test data

NOTE: The Style 108 Coupling is available only in the 1-inch/DN25 size

### WARNING

- Visual inspection of each joint is required.
- Improperly assembled joints shall be corrected before the system is filled, tested, or placed into service.
- Any components that exhibit physical damage due to improper assembly shall be replaced before the system is filled, tested, or placed into service.

Failure to follow these instructions could cause joint failure, resulting in death or serious personal injury and property damage.

**6a. REQUIRED INSPECTION TECHNIQUE – VISUAL INSPECTION FOR STYLE 108 COUPLINGS:** Visually inspect the bolt pad location at every joint to verify that metal-to-metal contact is achieved.

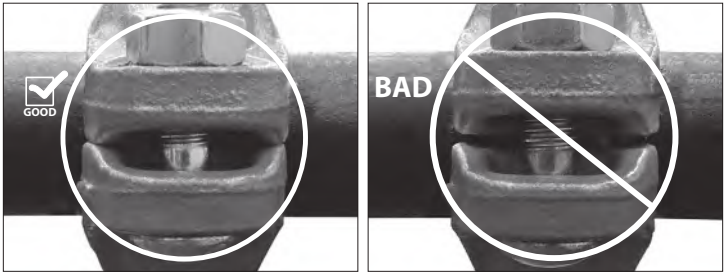

Continued on the following page

**6b. REQUIRED INSPECTION TECHNIQUE – VISUAL INSPECTION FOR STYLE 109 COUPLINGS:** Visually inspect the bolt pad location at every joint to verify that metal-to-metal contact is achieved around the bolt pad perimeter (approximately between the two sets of indicator arrows that are cast into the housings).

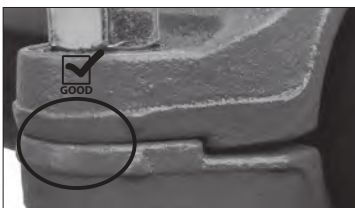
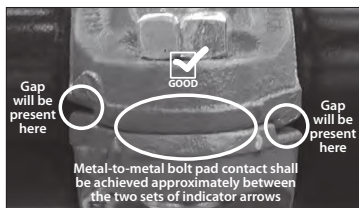

**6c. INSPECTION TECHNIQUE – TORQUE WRENCH METHOD FOR STYLE 108 AND 109 COUPLINGS:**

If additional coupling assembly inspection is determined to be necessary by others, a torque wrench method may be used. **NOTE:** Satisfying step 6b is first required before proceeding with the torque wrench method. The suggested bolt torque range for an assembled coupling that satisfies the visual inspection requirements of step 6b shall be as follows:

Bolt Size inches/ Metric	Minimum Assembled Bolt Torque*	Maximum Assembled Bolt Torque
3/8 M10	20 ft-lbs 27 N·m	55 ft-lbs 75 N·m

Bolt Size inches/ Metric	Minimum Assembled Bolt Torque*	Maximum Assembled Bolt Torque
7/16 M11	25 ft-lbs 34 N·m	80 ft-lbs 108 N·m

\* LPCB Compliant assemblies shall meet the Minimum Assembled Bolt Torque, as noted in the table above.

**Pipe Support Requirements During Construction Phase**

Style 108 and 109 Couplings require pipe support during construction of the piping system to prevent coupling or joint damage, which can reduce or eliminate rigidity of the finished assembly. Listed below are maximum allowable unsupported overhung pipe lengths. Pipe lengths longer than what is listed below shall be supported per the “Rigid Systems Pipe Support Spacing” section in this handbook.

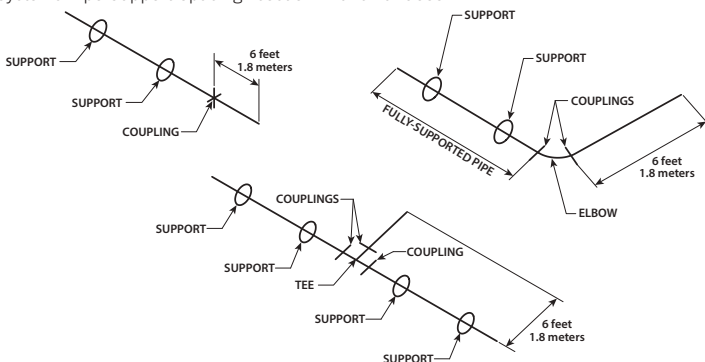

**! WARNING**



- Read and understand all instructions before attempting to install any Victaulic products.
- Always verify that the piping system has been completely depressurized and drained immediately prior to installation, removal, adjustment, or maintenance of any Victaulic products.
- Confirm that any equipment, branch lines, or sections of piping that may have been isolated for/during testing or due to valve closures/positioning are identified, depressurized, and drained immediately prior to installation, removal, adjustment, or maintenance of any Victaulic products.
- Wear safety glasses, hardhat, and foot protection.
- The Style 118 Victaulic® FireLock™ IGS™ Installation-Ready™ Outlet Coupling shall be used only in fire protection systems that are designed and installed in accordance with current, applicable National Fire Protection Association (NFPA 13, 13D, 13R, etc.) standards, or equivalent standards, and in accordance with applicable building and fire codes. These standards and codes contain important information regarding protection of systems from freezing temperatures, corrosion, mechanical damage, etc.
- These installation instructions are intended for an experienced, trained installer. The installer shall understand the use of this product and why it was specified for the particular application.
- The installer shall understand common industry safety standards and potential consequences of improper product installation.

Failure to follow installation requirements and local and national codes and standards could compromise system integrity or cause system failure, resulting in death or serious personal injury and property damage.

1. Follow all instructions in the “Preparatory Steps” section on pages 68 – 69.

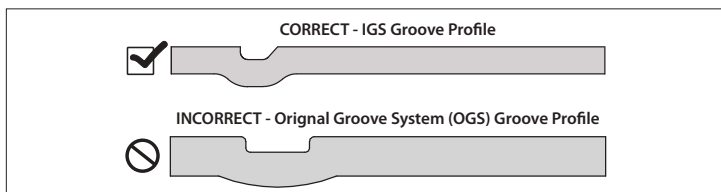

*Pipe and grooves are not shown to scale*

Style 118 FireLock™ IGS™ Installation-Ready™ Outlet Couplings shall be used **ONLY** with mating components that are prepared to Victaulic IGS proprietary groove specifications. **DO NOT** attempt to install this coupling on mating components that are prepared to any other groove specification.

## ! WARNING



- Never leave a Style 118 Outlet Coupling partially assembled on mating component ends. **ALWAYS TIGHTEN THE HARDWARE IMMEDIATELY, IN ACCORDANCE WITH THESE INSTRUCTIONS.** A partially assembled coupling poses a drop or fall hazard during installation and a burst hazard during testing.



- Keep hands away from the mating component ends and the openings of the coupling when attempting to insert grooved mating component ends into the coupling.

- Keep hands away from coupling openings during tightening.

Failure to follow these instructions could result in death or serious personal injury and property damage.



**4. ASSEMBLE JOINT:** Assemble the joint by inserting the grooved end of a mating component into each opening of the coupling. The grooved mating component ends shall be inserted into the coupling until contact with the pipe stop of the gasket occurs.

A visual check is required to verify that the coupling keys align with the groove in each mating component and that the gasket is seated properly. **NOTE:** Prior to tightening the nut, the coupling may be rotated to verify that the gasket is seated properly on the mating component ends and within the coupling housings.

### IMPORTANT INFORMATION FOR USE OF STYLE 118 OUTLET COUPLINGS WITH VICTAULIC NO. 146 IGS™ END CAPS AND OTHER IGS™ FITTINGS:

## ! WARNING

- Always read and follow the “Victaulic End Cap Installation Safety Instructions” section in this handbook.

Failure to follow the “Victaulic End Cap Installation Safety Instructions” section could result in death or serious personal injury and property damage.

- When assembling Style 118 Outlet Couplings onto Victaulic® No. 146 IGS™ End Caps, take additional time to inspect and verify that the IGS™ End Cap is seated fully against the pipe stop of the gasket.
- Always confirm that any equipment, branch lines, or sections of piping that may have been isolated for/during testing or due to valve closures/positioning are identified, depressurized, and drained immediately prior to working with an end cap.

## ! WARNING

- The nut shall be tightened until metal-to-metal contact occurs at the bolt pads, as indicated in steps 5 and 6.
- **DO NOT** continue to tighten the nut after the visual, metal-to-metal bolt pad inspection requirement is achieved.

Failure to follow instructions for tightening hardware could result in:

- Damage to the assembled joint (damaged or broken bolt pads or fractures to housings)
- Bolt damage or fracture
- Joint leakage and property damage
- A negative impact on system integrity
- Personal injury or death

## NOTICE

- An impact tool or standard socket wrench with a deep-well socket can be used to bring the bolt pads into metal-to-metal contact.
- Refer to the “Impact Tool Usage Guidelines” and “Impact Tool Selection” sections in this handbook.



**5. TIGHTEN NUT:** Using an impact tool or a standard socket wrench with an  $1\frac{1}{16}$ -inch (for Imperial nuts)/17-mm (for Metric nuts) deep-well socket, tighten the nut until metal-to-metal contact occurs at the bolt pads. Verify that the oval neck of the bolt seats properly in the bolt hole. **DO NOT** continue to tighten the nut after the visual, metal-to-metal bolt pad inspection requirement is achieved. **If you suspect that any hardware has been over-tightened (as indicated by a bend in the bolt, bulging of the nut at the bolt pad interface, or damage to the bolt pad, etc.), the entire coupling assembly shall be replaced immediately.** Refer to the “Impact Tool Usage Guidelines” and “Impact Tool Selection” sections in this handbook.



OVAL NECK OF BOLT  
SEATED PROPERLY



OVAL NECK OF BOLT  
NOT SEATED PROPERLY

## ! WARNING

- Visual inspection of each joint is required.
- Improperly assembled joints shall be corrected before the system is filled, tested, or placed into service.
- Any components that exhibit physical damage due to improper assembly shall be replaced before the system is filled, tested, or placed into service.

Failure to follow these instructions could cause joint failure, resulting in death or serious personal injury and property damage.

**6. REQUIRED INSPECTION TECHNIQUE – VISUAL INSPECTION:** Visually inspect the bolt pad location at every joint to verify that metal-to-metal contact is achieved across the entire bolt pad section.

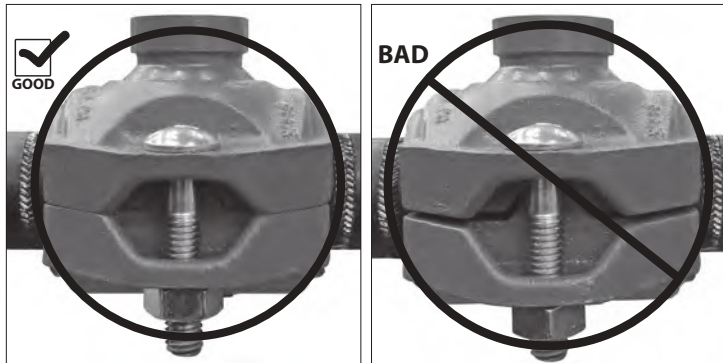

**6a. INSPECTION TECHNIQUE – TORQUE WRENCH METHOD:** If additional coupling assembly inspection is determined to be necessary by others, a torque wrench method may be used. **NOTE:** Satisfying step 6 is first required before proceeding with the torque wrench method. The suggested bolt torque range for an assembled coupling that satisfies the visual inspection requirements of step 6 shall be as follows:

Bolt Size inches/ Metric	Minimum Assembled Bolt Torque*	Maximum Assembled Bolt Torque
$\frac{3}{8}$ M10	20 ft-lbs 27 N·m	55 ft-lbs 75 N·m

\* LPCB Compliant assemblies shall meet the Minimum Assembled Bolt Torque, as noted in the table above.



**7.** Install the Victaulic® VicFlex™ flexible hose with captured coupling in accordance with the applicable instructions found in the I-VICFLEX handbook, which can be downloaded at [victaulic.com](http://victaulic.com).

# INSTRUCTIONS FOR REASSEMBLY OF STYLE 108 AND 109 COUPLINGS

## WARNING



- Always verify that the piping system has been completely depressurized and drained immediately prior to installation, removal, adjustment, or maintenance of any Victaulic products.
- Confirm that any equipment, branch lines, or sections of piping that may have been isolated for/during testing or due to valve closures/positioning are identified, depressurized, and drained immediately prior to installation, removal, adjustment, or maintenance of any Victaulic products.  
Failure to follow this instruction could result in death or serious personal injury and property damage.

1. Verify that the system is depressurized and drained completely before attempting to disassemble any couplings.
2. Loosen the nut of the coupling assembly to permit removal of the coupling from the mating component ends.
3. Remove the nut, bolt, gasket, and linkage from the housings. Inspect all components for any damage or wear. If any damage or wear is present, use a new Victaulic-supplied coupling assembly.
4. Check mating component ends, as described in step 2 on page 69.

## NOTICE

- The photos in this section show reassembly of a Style 109 Coupling; however, the same steps apply to reassembly of a Style 108 Coupling.

## CAUTION

- A thin coat of a compatible lubricant shall be used to help prevent the gasket from pinching, rolling, or tearing during reassembly.
  - DO NOT use excessive lubricant on the gasket sealing lips and exterior.
- Failure to use a compatible lubricant may cause gasket damage, resulting in joint leakage and property damage.



- 5. FOR REASSEMBLY OF STYLE 108 AND 109 COUPLINGS, LUBRICATE GASKET:** Apply a thin coat of a compatible lubricant to the gasket sealing lips and exterior. Refer to the “Lubricant Compatibility for Gaskets” table on page 34.



- 6. INSTALL GASKET INTO FIRST COUPLING HOUSING:** Install the gasket into one of the housings. Verify that the gasket is seated fully in the housing’s pocket.

*Instructions continue on the following page*



**7. INSTALL SECOND COUPLING HOUSING AND LINKAGE:** Install the second coupling housing. Verify that the gasket is seated in the housings' pockets. Install the linkage onto the housings, as shown to the left.



**8. INSTALL BOLT AND NUT:** Install the bolt, and thread a nut onto the bolt. **NOTE:** Verify that the oval neck of the bolt seats properly in the bolt hole. DO NOT tighten the nut completely. The bolt pads need to be set at a gap for reinstallation of the coupling. The nut should be flush with the top of the bolt to provide the proper gap.

9. Follow all steps on pages 71 – 74 to complete the assembly.

# INSTRUCTIONS FOR REASSEMBLY OF STYLE 118 OUTLET COUPLINGS

## WARNING



- Always verify that the piping system has been completely depressurized and drained immediately prior to installation, removal, adjustment, or maintenance of any Victaulic products.
- Confirm that any equipment, branch lines, or sections of piping that may have been isolated for/during testing or due to valve closures/positioning are identified, depressurized, and drained immediately prior to installation, removal, adjustment, or maintenance of any Victaulic products.  
Failure to follow this instruction could result in death or serious personal injury and property damage.

1. Verify that the system is depressurized and drained completely before attempting to disassemble any couplings.
2. Loosen the nut of the coupling assembly to permit removal of the coupling from the mating component ends. **NOTE:** When removing the captured coupling of the Victaulic® VicFlex™ flexible hose, refer to the applicable I-VICFLEX document for complete instructions.
3. Remove the nut, bolt, gasket, and linkage from the housings. Inspect all components for any damage or wear. If any damage or wear is present, use a new Victaulic-supplied coupling assembly.
4. Check mating component ends, as described in step 2 on page 69.

## CAUTION

- A thin coat of a compatible lubricant shall be used to help prevent the gasket from pinching, rolling, or tearing during reassembly.
  - **DO NOT** use excessive lubricant on the gasket sealing lips and exterior.
- Failure to use a compatible lubricant may cause gasket damage, resulting in joint leakage and property damage.



- 5. FOR REASSEMBLY OF STYLE 118 OUTLET COUPLINGS, LUBRICATE GASKET:**  
Apply a thin coat of a compatible lubricant to the three gasket sealing lips and exterior. Refer to the “Lubricant Compatibility for Gaskets” table on page 34.

*Instructions continue on the following page*



**6. INSTALL GASKET INTO OUTLET HOUSING:**

Install the gasket into the outlet housing. Verify that the housing's outlet engages with the outlet portion of the gasket.



**6a. INSTALL SECOND HOUSING AND LINKAGE:**

Install the second housing. Verify that the gasket is seated in the housings' pockets. Install the linkage onto the housings, as shown to the left.

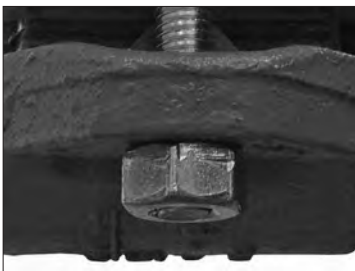

**7. INSTALL BOLT AND NUT:** Install the bolt, and thread a nut onto the bolt. **NOTE:** Verify that the oval neck of the bolt seats properly in the bolt hole. **DO NOT** tighten the nut completely. The bolt pads need to be set at a gap for reinstallation of the coupling. The nut should be flush with the top of the bolt to provide the proper gap.

**8.** Follow all steps on pages 76 – 78 to complete the assembly.

# **Installation-Ready™ Couplings for Grooved-End Mating Components**

**Instructions for Initial Installation**

**Instructions for Reassembly**

# PREPARATORY STEPS FOR INSTALLATION OF COUPLINGS FEATURED IN THIS SECTION

## ! WARNING



- Read and understand all instructions before attempting to install any Victaulic products.
- Always verify that the piping system has been completely depressurized and drained immediately prior to installation, removal, adjustment, or maintenance of any Victaulic products.
- Confirm that any equipment, branch lines, or sections of piping that may have been isolated for/during testing or due to valve closures/positioning are identified, depressurized, and drained immediately prior to installation, removal, adjustment, or maintenance of any Victaulic products.
- These installation instructions are intended for an experienced, trained installer. The installer shall understand the use of this product and why it was specified for the particular application.
- The installer shall understand common industry safety standards and potential consequences of improper product installation.
- Wear safety glasses, hardhat, and foot protection.

Failure to follow these instructions could result in death or serious personal injury and property damage.

## ! WARNING

- Style 004N, 009N, 107V, 107N, 171, 177N, 807N, and 877N Couplings shall be used **ONLY** with mating components that are prepared to Victaulic OGS groove specifications.
- Style 115 Reducing Couplings shall be used with mating components that are prepared to Victaulic IGS proprietary groove specifications and OGS groove specifications.
- **DO NOT** attempt to install these products on mating components that are prepared to any groove specification other than what is specified in their respective installation instructions.

Failure to follow these instructions could cause joint failure, resulting in death or serious personal injury and property damage.

## Instructions for the Initial Installation of Style 004N, 009N, 107V, 107N, 115, 171, 177N, 807N, and 877N Couplings

## NOTICE

- The photos in this section show installation of a Style 107V Coupling; however, the same steps apply to installation of all other couplings listed above.

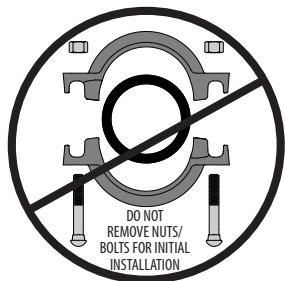

### 1. DO NOT DISASSEMBLE THE COUPLING:

Installation-Ready™ Couplings are designed so that the installer does not need to remove the nuts and bolts for initial installation. This facilitates installation by allowing the installer to directly insert the grooved end of mating components into the coupling.

**2. CHECK MATING COMPONENT ENDS:** The outside surface of the mating components, between the groove and the mating component ends, shall be generally free from indentations, projections, weld seam anomalies, and roll marks to ensure a leak-tight seal. All oil, grease, loose paint, dirt, and cutting particles shall be removed. Always verify that the correct groove profile is being used.

The mating components' outside diameter ("OD"), groove dimensions, and maximum allowable flare diameter shall be within the tolerances listed in this handbook for Victaulic OGS groove specifications (or IGS and OGS groove specifications for the Style 115 Reducing Coupling).

## NOTICE

- For Victaulic® FireLock™ products that are provided with pre-lubricated gaskets, refer to the "NOTICE" and the "Dry Pipe Fire Protection Systems Notes" section on page 36 for additional information.

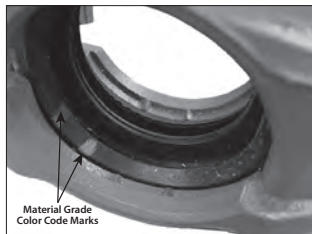

**3a. CHECK GASKET:** Check the gasket to verify that it is suitable for the intended service. The color code identifies the material grade. Refer to page 32 for the "Gasket Color Code Reference" table. For complete compatibility information, reference Victaulic publications 05.01 and GSG-100, which can be downloaded at [victaulic.com](http://victaulic.com). For FireLock™ products, refer to the "NOTICE" on page 36 for important gasket information.

**3b. FOR STYLE 107V AND 177N COUPLINGS, IF THE GASKET IS MARKED WITH GREEN AND YELLOW STRIPES OR ORANGE AND YELLOW STRIPES:** LUBRICATION OF THE GASKET SEALING LIPS IS OPTIONAL, PROCEED TO THE STYLE 107V (PAGE 95) OR 177N (PAGE 112) INSTALLATION INSTRUCTIONS IN THIS SECTION.

**3c. For all other marked gaskets, including red and green stripes or orange and silver stripes, and for FireLock™ products that meet any conditions in the "NOTICE" on page 36:** Apply a thin coat of a compatible lubricant only to the gasket sealing lips. Refer to the "Lubricant Compatibility for Gaskets" table on page 34. **NOTE:** It is not necessary to remove the gasket from the housings to apply lubricant to the exterior surface.



## ! CAUTION

For all other marked gaskets, including red and green stripes or orange and silver stripes, and for FireLock™ products that meet any conditions in the "NOTICE" on page 36:

- A thin coat of a compatible lubricant shall be applied only to the gasket sealing lips to help prevent the gasket from pinching, rolling, or tearing during installation.
- DO NOT use excessive lubricant on the gasket sealing lips.
- When using the Style 171 Composite Flexible Coupling with HDPE pipe, always consult the pipe manufacturer for lubricant compatibility requirements.

Failure to use a compatible lubricant may cause gasket damage, resulting in joint leakage and property damage.

**! WARNING**



- Read and understand all instructions before attempting to install any Victaulic products.
- Always verify that the piping system has been completely depressurized and drained immediately prior to installation, removal, adjustment, or maintenance of any Victaulic products.
- Confirm that any equipment, branch lines, or sections of piping that may have been isolated for/during testing or due to valve closures/positioning are identified, depressurized, and drained immediately prior to installation, removal, adjustment, or maintenance of any Victaulic products.
- Wear safety glasses, hardhat, and foot protection.
- Style 004N Victaulic® FireLock™ Installation-Ready™ Flexible Couplings shall be used only in fire protection systems that are designed and installed in accordance with current, applicable National Fire Protection Association (NFPA 13, 13D, 13R, etc.) standards, or equivalent standards, and in accordance with applicable building and fire codes. These standards and codes contain important information regarding protection of systems from freezing temperatures, corrosion, mechanical damage, etc.
- These installation instructions are intended for an experienced, trained installer. The installer shall understand the use of this product and why it was specified for the particular application.
- The installer shall understand common industry safety standards and potential consequences of improper product installation.

Failure to follow installation requirements and local and national codes and standards could compromise system integrity or cause system failure, resulting in death or serious personal injury and property damage.

1. Follow all instructions in the “Preparatory Steps” section on pages 84 – 85.

OGS Roll Groove Profile Shown



*Pipe and groove are not shown to scale*

Style 004N Couplings shall be used ONLY with mating components that are prepared to Victaulic OGS groove specifications. **DO NOT** attempt to install these couplings on mating components that are prepared to any other groove specification.

**! WARNING**



- Never leave a Style 004N Coupling partially assembled on mating component ends. **ALWAYS TIGHTEN THE HARDWARE IMMEDIATELY, IN ACCORDANCE WITH THESE INSTRUCTIONS.** A partially assembled coupling poses a drop or fall hazard during installation and a burst hazard during testing.



- Keep hands away from the mating component ends and the openings of the coupling when attempting to insert grooved mating component ends into the coupling.
  - Keep hands away from coupling openings during tightening.
- Failure to follow these instructions could result in death or serious personal injury and property damage.

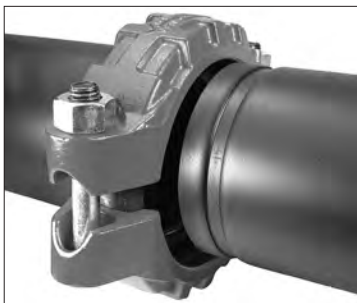

**5. ASSEMBLE JOINT:** Assemble the joint by inserting the grooved end of a mating component into each opening of the coupling. The grooved mating component ends shall be inserted into the coupling until contact with the center leg of the gasket occurs.

A visual check is required to verify that the coupling keys align with the groove of each mating component and that the gasket is seated properly. **NOTE:** Prior to tightening the nuts, the coupling may be rotated to verify that the gasket is seated properly on the mating component ends and within the coupling housings.

**IMPORTANT INFORMATION FOR USE OF STYLE 004N COUPLINGS WITH END CAPS AND FITTINGS:**

**! WARNING**

- Always read and follow the “Victaulic End Cap Installation Safety Instructions” section in this handbook.

Failure to follow the “Victaulic End Cap Installation Safety Instructions” section could result in death or serious personal injury and property damage.

- When assembling Style 004N Couplings onto end caps, take additional time to inspect and verify that the end cap is seated fully against the center leg of the gasket.
- Use only Victaulic FireLock™ No. 006 End Caps containing the “EZ” marking on the inside face or Victaulic End Caps containing the “QV” or “EZ QV” marking on the inside face.
- Always confirm that any equipment, branch lines, or sections of piping that may have been isolated for/during testing or due to valve closures/positioning are identified, depressurized, and drained immediately prior to working with an end cap.
- Victaulic recommends the use of Victaulic FireLock™ fittings with Style 004N Couplings.

**! WARNING**

- Nuts shall be tightened evenly by alternating sides, maintaining nearly uniform bolt pad gaps, until metal-to-metal contact occurs at the bolt pads, as indicated in steps 6 and 7.

Failure to tighten nuts as instructed will cause increased loading of the hardware, resulting in the following conditions:

- Excessive bolt torque required to assemble the joint (incomplete assembly)
- Damage to the assembled joint (damaged or broken bolt pads or fractures to housings)
- Bolt damage or fracture
- Joint leakage and property damage
- A negative impact on system integrity
- Personal injury or death

DO NOT continue to tighten the nuts after the visual, metal-to-metal bolt pad inspection requirement is achieved.

- Failure to follow this instruction could result in the conditions listed above.

## NOTICE

- It is important to tighten the nuts evenly by alternating sides to prevent gasket pinching.
- An impact tool or standard socket wrench with a deep-well socket can be used to bring the bolt pads into metal-to-metal contact.
- Refer to the “Impact Tool Usage Guidelines” and “Impact Tool Selection” sections in this handbook, along with the “Helpful Information” table below.



**6. TIGHTEN NUTS:** Using an impact tool or a standard socket wrench with a deep-well socket, tighten the nuts evenly by alternating sides, maintaining nearly uniform bolt pad gaps, until metal-to-metal contact occurs at the bolt pads. Verify that the oval neck of each bolt seats properly in the bolt holes. DO NOT continue to tighten the nuts after the visual, metal-to-metal bolt pad inspection requirement is achieved. **If you suspect that any hardware has been over-tightened (as indicated by a bend in the bolt, bulging of the nut at the bolt pad interface, or damage to the bolt pad, etc.), the entire coupling assembly shall be replaced immediately.** Refer to the “Impact Tool Usage Guidelines” and “Impact Tool Selection” sections in this handbook, along with the “Helpful Information” table below.

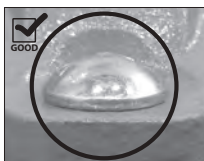

OVAL NECK OF BOLT  
SEATED PROPERLY



OVAL NECK OF BOLT  
NOT SEATED PROPERLY

### Helpful Information

Nominal Pipe Size inches/DN	Actual Pipe Outside Diameter inches/mm	Nut Size inches/ Metric	Deep-Well Socket Size inches/mm	Maximum Allowable Bolt Torque*
2 – 3 DN50 – DN80	2.375 – 3.500 60.3 – 88.9	1/2 M12	7/8 22	135 ft-lbs 183 N•m
4 DN100	4.500 114.3	5/8 M16	1 1/16 27	235 ft-lbs 319 N•m
5	5.563 141.3	3/4 M20	1 1/4 32	425 ft-lbs 576 N•m
6 DN150	6.625 168.3	3/4 M20	1 1/4 32	425 ft-lbs 576 N•m
8 DN200	8.625 219.1	7/8 M22	1 7/16 36	675 ft-lbs 915 N•m

\*Maximum allowable bolt torque values have been derived from actual test data



INSTALLATION-READY™ COUPLINGS FOR  
GROOVED-END MATING COMPONENTS  
INSTALLATION INSTRUCTIONS REV\_H

## WARNING

- Visual inspection of each joint is required.
  - Improperly assembled joints shall be corrected before the system is filled, tested, or placed into service.
  - Any components that exhibit physical damage due to improper assembly shall be replaced before the system is filled, tested, or placed into service.
- Failure to follow these instructions could cause joint failure, resulting in death or serious personal injury and property damage.

7. Visually inspect each bolt pad location at every joint to verify that metal-to-metal contact is achieved across the entire bolt pad section.

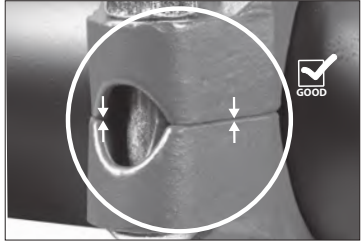
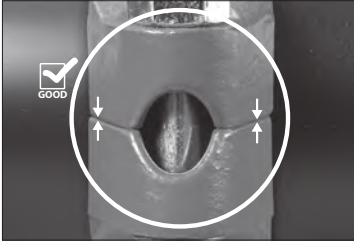

**PROPERLY ASSEMBLED JOINT – METAL-TO-METAL CONTACT AS INDICATED**

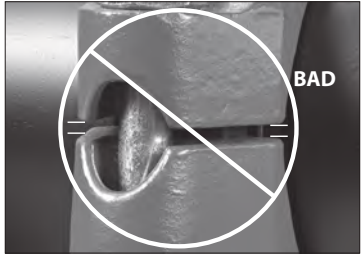
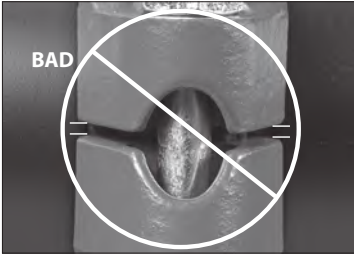

**IMPROPERLY ASSEMBLED JOINT – BOLT PAD GAP/UNDER-TIGHTENED**

Bolt pad gaps occur when the nuts are not tightened sufficiently. Refer to the “Impact Tool Usage Guidelines” section in this handbook. These photos represent improper assemblies, which could result in joint failure, property damage, serious personal injury, or death.

**! WARNING**



- Read and understand all instructions before attempting to install any Victaulic products.
- Always verify that the piping system has been completely depressurized and drained immediately prior to installation, removal, adjustment, or maintenance of any Victaulic products.
- Confirm that any equipment, branch lines, or sections of piping that may have been isolated for/during testing or due to valve closures/positioning are identified, depressurized, and drained immediately prior to installation, removal, adjustment, or maintenance of any Victaulic products.
- Wear safety glasses, hardhat, and foot protection.
- Style 009N Victaulic® FireLock EZ™ Installation-Ready™ Rigid Couplings shall be used only in fire protection systems that are designed and installed in accordance with current, applicable National Fire Protection Association (NFPA 13, 13D, 13R, etc.) standards, or equivalent standards, and in accordance with applicable building and fire codes. These standards and codes contain important information regarding protection of systems from freezing temperatures, corrosion, mechanical damage, etc.
- These installation instructions are intended for an experienced, trained installer. The installer shall understand the use of this product and why it was specified for the particular application.
- The installer shall understand common industry safety standards and potential consequences of improper product installation.

Failure to follow installation requirements and local and national codes and standards could compromise system integrity or cause system failure, resulting in death or serious personal injury and property damage.

1. Follow all instructions in the “Preparatory Steps” section on pages 84 – 85.

OGS Roll Groove Profile Shown



*Pipe and groove are not shown to scale*

Style 009N Couplings shall be used ONLY with mating components that are prepared to Victaulic OGS groove specifications. **DO NOT** attempt to install this coupling on mating components that are prepared to any other groove specification.



**NOTICE**

- When stainless steel hardware is special ordered, the bolt head will contain a “316” mark, as shown to the left.

**! WARNING**



- Never leave a Style 009N Coupling partially assembled on mating component ends. **ALWAYS TIGHTEN THE HARDWARE IMMEDIATELY, IN ACCORDANCE WITH THESE INSTRUCTIONS.** A partially assembled coupling poses a drop or fall hazard during installation and a burst hazard during testing.
- Keep hands away from the mating component ends and the openings of the coupling when attempting to insert grooved mating component ends into the coupling.
- Keep hands away from coupling openings during tightening.

Failure to follow these instructions could result in death or serious personal injury and property damage.





**4. ASSEMBLE JOINT:** Assemble the joint by inserting the grooved end of a mating component into each opening of the coupling. The grooved mating component ends shall be inserted into the coupling until contact with the center leg of the gasket occurs.

A visual check is required to verify that the coupling keys align with the groove of each mating component and that the gasket is seated properly. **NOTE:** Prior to tightening the nuts, the coupling may be rotated to verify that the gasket is seated properly on the mating component ends and within the coupling housings.

#### **IMPORTANT INFORMATION FOR USE OF STYLE 009N COUPLINGS WITH END CAPS AND FITTINGS:**

### **! WARNING**

- Always read and follow the “Victaulic End Cap Installation Safety Instructions” section in this handbook.

**Failure to follow the “Victaulic End Cap Installation Safety Instructions” section could result in death or serious personal injury and property damage.**

- When assembling Style 009N Couplings onto end caps, take additional time to inspect and verify that the end cap is seated fully against the center leg of the gasket.
- Use only Victaulic FireLock™ No. 006 End Caps containing the “EZ” marking on the inside face or Victaulic End Caps containing the “QV” or “EZ QV” marking on the inside face.
- Always confirm that any equipment, branch lines, or sections of piping that may have been isolated for/during testing or due to valve closures/positioning are identified, depressurized, and drained immediately prior to working with an end cap.
- Victaulic recommends the use of Victaulic FireLock™ fittings with Style 009N Couplings.

### **! WARNING**

- Nuts shall be tightened evenly by alternating sides, maintaining nearly uniform bolt pad gaps, until metal-to-metal contact occurs at the angled bolt pads, as indicated in steps 5 and 6.
- Equal and positive or neutral offsets shall be present at the angled bolt pads, as indicated in steps 5 and 6.

**Failure to tighten nuts as instructed will cause increased loading of the hardware, resulting in the following conditions:**

- Excessive bolt torque required to assemble the joint (incomplete assembly)
- Damage to the assembled joint (damaged or broken bolt pads or fractures to housings)
- Bolt damage or fracture
- Joint leakage and property damage
- A negative impact on system integrity
- Personal injury or death

**DO NOT** continue to tighten the nuts after the visual, metal-to-metal bolt pad inspection requirement is achieved.

- Failure to follow this instruction could result in the conditions listed above.

## NOTICE

- It is important to tighten the nuts evenly by alternating sides to prevent gasket pinching.
- An impact tool or standard socket wrench with a deep-well socket can be used to bring the bolt pads into metal-to-metal contact.
- Refer to the “Impact Tool Usage Guidelines” and “Impact Tool Selection” sections in this handbook, along with the “Helpful Information” table on the following page.



**5. TIGHTEN NUTS:** Using an impact tool or a standard socket wrench with a deep-well socket, tighten the nuts evenly by alternating sides, maintaining nearly uniform bolt pad gaps, until metal-to-metal contact occurs at the angled bolt pads. Equal and positive or neutral offsets shall be present at the bolt pads. Verify that the oval neck of each bolt seats properly in the bolt holes. DO NOT continue to tighten the nuts after the visual, metal-to-metal bolt pad inspection requirement is achieved. **If you suspect that any hardware has been over-tightened (as indicated by a bend in the bolt, bulging of the nut at the bolt pad interface, or damage to the bolt pad, etc.), the entire coupling assembly shall be replaced immediately.** Refer to the “Impact Tool Usage Guidelines” and “Impact Tool Selection” sections in this handbook, along with the “Helpful Information” table on the following page.

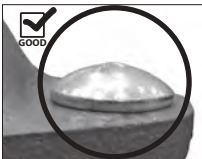

OVAL NECK OF BOLT  
SEATED PROPERLY



OVAL NECK OF BOLT  
NOT SEATED PROPERLY

## Helpful Information

Nominal Pipe Size inches/DN	Actual Pipe Outside Diameter inches/mm	Nut Size inches/Metric	Deep-Well Socket Size inches/mm	Maximum Allowable Bolt Torque*
1 ¼ – 4 DN32 – DN100	1.660 – 4.500 42.4 – 114.3	¾ M10	1½ 17	55 ft-lbs 75 N•m
	5.250 133.0	½ M12	¾ 22	135 ft-lbs 183 N•m
DN125	5.500 139.7	½ M12	¾ 22	135 ft-lbs 183 N•m
5	5.563 141.3	½ M12	¾ 22	135 ft-lbs 183 N•m
	6.250 – 6.500 159.0 – 165.1	½ M12	¾ 22	135 ft-lbs 183 N•m
6 DN150	6.625 168.3	½ M12	¾ 22	135 ft-lbs 183 N•m
	8.500 216.0	⅝ M16	1 ⅛ 27	235 ft-lbs 319 N•m
8 DN200	8.625 219.1	⅝ M16	1 ⅛ 27	235 ft-lbs 319 N•m
10 – 12 DN250 – DN300	10.750 – 12.750 273.0 – 323.9	¾ M22	1 ⅛ 36	675 ft-lbs 915 N•m

\*Maximum allowable bolt torque values have been derived from actual test data

### WARNING

- Visual inspection of each joint is required.
- Improperly assembled joints shall be corrected before the system is filled, tested, or placed into service.
- Any components that exhibit physical damage due to improper assembly shall be replaced before the system is filled, tested, or placed into service.

Failure to follow these instructions could cause joint failure, resulting in death or serious personal injury and property damage.

**6. REQUIRED INSPECTION TECHNIQUE – VISUAL INSPECTION:** Visually inspect each bolt pad location at every joint to verify that metal-to-metal contact is achieved across the entire bolt pad section. Equal and positive or neutral offsets shall be present at each bolt pad location.

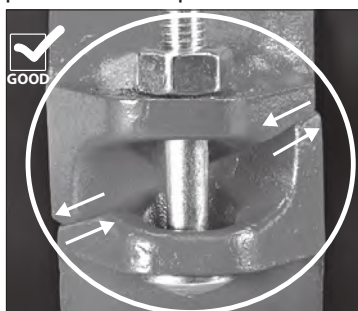

**PROPERLY ASSEMBLED JOINT  
METAL-TO-METAL CONTACT AT ANGLED  
BOLT PADS WITH EQUAL, POSITIVE  
OFFSETS AT THE BOLT PADS**

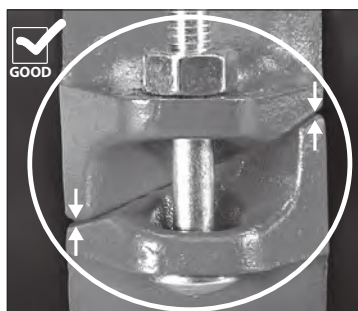

**PROPERLY ASSEMBLED JOINT  
METAL-TO-METAL CONTACT AT ANGLED  
BOLT PADS WITH EQUAL, NEUTRAL  
OFFSETS AT THE BOLT PADS**

*Continued on the following page*

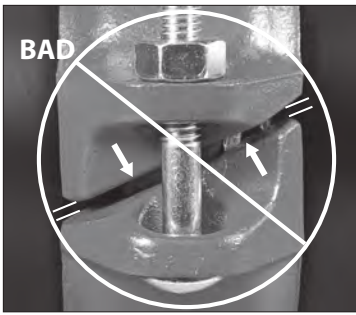

**IMPROPERLY ASSEMBLED JOINT  
BOLT PAD GAP**

Bolt pad gaps occur when the nuts are not tightened sufficiently or if the hardware is not tightened evenly by alternating sides. Refer to the “Improperly Assembled Joint – Over-Shifted” section below. In addition, refer to the “Impact Tool Usage Guidelines” and “Impact Tool Selection” sections in this handbook. This represents an improper assembly, which could result in joint failure, property damage, serious personal injury, or death.

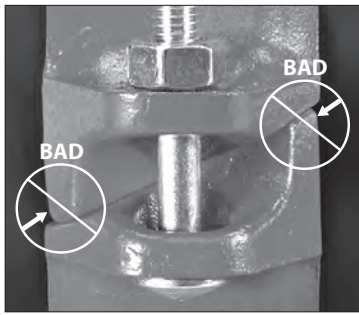

**IMPROPERLY ASSEMBLED JOINT  
NEGATIVE OFFSET**

Negative bolt pad offsets occur when the nuts are not tightened evenly, which produces over-tightening of one side and under-tightening of the other side. In addition, negative offsets occur if both nuts are under-tightened. Refer to the “Impact Tool Usage Guidelines” and “Impact Tool Selection” sections in this handbook. This represents an improper assembly, which could result in joint failure, property damage, serious personal injury, or death.

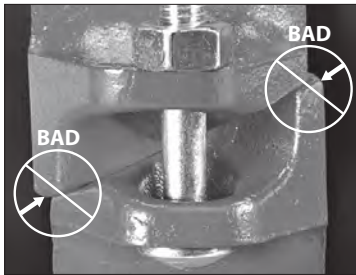

**IMPROPERLY ASSEMBLED JOINT – OVER-SHIFTED**

Over-shifting of an angled bolt pad results in an offset that prevents metal-to-metal contact and equal and positive or neutral offset at the opposite angled bolt pad. This occurs when the hardware is not tightened evenly by alternating sides. Attempting to tighten the hardware on one side while the other side is over-shifted will result in bolt torque that exceeds the “Maximum Allowable Bolt Torque” values specified in the “Helpful Information” table in this section. Refer to the “Impact Tool Usage Guidelines” and “Impact Tool Selection” sections in this handbook. This represents an improper assembly, which could result in joint failure, property damage, serious personal injury, or death.





**6a. INSPECTION TECHNIQUE – TORQUE WRENCH METHOD:** If additional coupling assembly inspection is determined to be necessary by others, a torque wrench method may be used. **NOTE:** Satisfying step 6 is first required before proceeding with the torque wrench method. The suggested bolt torque range for an assembled coupling that satisfies the visual inspection requirements of step 6 shall be as follows:

Bolt Size inches/ Metric	Minimum Assembled Bolt Torque*	Maximum Assembled Bolt Torque
3/8 M10	20 ft-lbs 27 N•m	55 ft-lbs 75 N•m
1/2 M12	30 ft-lbs 41 N•m	125 ft-lbs 169 N•m

Bolt Size inches/ Metric	Minimum Assembled Bolt Torque*	Maximum Assembled Bolt Torque
5/8 M16	40 ft-lbs 54 N•m	175 ft-lbs 237 N•m
7/8 M22	225 ft-lbs 305 N•m	350 ft-lbs 475 N•m

\* LPCB Compliant assemblies shall meet the Minimum Assembled Bolt Torque, as noted in the table above.



<b>! WARNING</b>				
				
<ul style="list-style-type: none"> <li>• Read and understand all instructions before attempting to install any Victaulic products.</li> <li>• Always verify that the piping system has been completely depressurized and drained immediately prior to installation, removal, adjustment, or maintenance of any Victaulic products.</li> <li>• Confirm that any equipment, branch lines, or sections of piping that may have been isolated for/during testing or due to valve closures/positioning are identified, depressurized, and drained immediately prior to installation, removal, adjustment, or maintenance of any Victaulic products.</li> <li>• These installation instructions are intended for an experienced, trained installer. The installer shall understand the use of this product and why it was specified for the particular application.</li> <li>• The installer shall understand common industry safety standards and potential consequences of improper product installation.</li> <li>• Wear safety glasses, hardhat, and foot protection.</li> </ul> <p>Failure to follow these instructions could result in death or serious personal injury and property damage.</p>				

1. Follow all instructions in the “Preparatory Steps” section on pages 84 – 85.

OGS Roll Groove Profile Shown



*Pipe and groove are not shown to scale*

Style 107V Couplings shall be used ONLY with mating components that are prepared to Victaulic OGS groove specifications. **DO NOT** attempt to install these couplings on mating components that are prepared to any other groove specification.

<b>! WARNING</b>	
	<ul style="list-style-type: none"> <li>• Never leave a Style 107V Coupling partially assembled on mating component ends. <b>ALWAYS TIGHTEN THE HARDWARE IMMEDIATELY, IN ACCORDANCE WITH THESE INSTRUCTIONS.</b> A partially assembled coupling poses a drop or fall hazard during installation and a burst hazard during testing.</li> <li>• Keep hands away from the mating component ends and the openings of the coupling when attempting to insert grooved mating component ends into the coupling.</li> <li>• Keep hands away from coupling openings during tightening.</li> </ul> <p>Failure to follow these instructions could result in death or serious personal injury and property damage.</p>
	



**4. ASSEMBLE JOINT:** Assemble the joint by inserting the grooved end of a mating component into each opening of the coupling. The grooved mating component ends shall be inserted into the coupling until contact with the center leg of the gasket occurs.

A visual check is required to verify that the coupling keys align with the groove of each mating component and that the gasket is seated properly. **NOTE:** Prior to tightening the nuts, the coupling may be rotated to verify that the gasket is seated properly on the mating component ends and within the coupling housings.

#### **IMPORTANT INFORMATION FOR USE OF STYLE 107V COUPLINGS WITH END CAPS AND FITTINGS:**

### **! WARNING**

- Always read and follow the “Victaulic End Cap Installation Safety Instructions” section in this handbook.

Failure to follow the “Victaulic End Cap Installation Safety Instructions” section could result in death or serious personal injury and property damage.

- When assembling Style 107V Couplings onto end caps, take additional time to inspect and verify that the end cap is seated fully against the center leg of the gasket.
- Use only Victaulic End Caps containing the “QV” or “EZ QV” marking on the inside face.
- Always confirm that any equipment, branch lines, or sections of piping that may have been isolated for/during testing or due to valve closures/positioning are identified, depressurized, and drained immediately prior to working with an end cap.
- Victaulic recommends the use of Victaulic fittings with Style 107V Couplings.

### **! WARNING**

- Nuts shall be tightened until metal-to-metal contact occurs at the bolt pads, as indicated in steps 5 and 6. For couplings shipped with a tag attached to the bolt pads, use only the Method 2 (Alternating Sides) assembly technique detailed on the following page.
- Hardware for Style 107V Couplings may be tightened completely on one side before proceeding to the other side. It is the contractor’s responsibility to use this installation method **ONLY** for the Style 107V Coupling. All other Victaulic couplings shall be installed per the requirements published in their specific installation instructions.
- **DO NOT** exceed the “Maximum Allowable Bolt Torque” values specified in the table on the following page for the applicable bolt/nut size.

Failure to tighten nuts as instructed will cause increased loading of the hardware, resulting in the following conditions:

- Excessive bolt torque required to assemble the joint (incomplete assembly)
- Damage to the assembled joint (damaged or broken bolt pads or fractures to housings)
- Bolt fracture or damage that makes the bolt more susceptible to fracture
- Joint leakage and property damage
- A negative impact on system integrity
- Personal injury or death

**DO NOT** continue to tighten the nuts after the visual, metal-to-metal bolt pad inspection requirement is achieved.

- Failure to follow this instruction could result in the conditions listed above.

## NOTICE

- An impact tool or standard socket wrench with a deep-well socket can be used to bring the bolt pads into metal-to-metal contact.
- Refer to the “Impact Tool Usage Guidelines” and “Impact Tool Selection” sections in this handbook, along with the “Helpful Information” table below.



**5. TIGHTEN NUTS:** Using an impact tool or a standard socket wrench with a deep-well socket, tighten the nuts until metal-to-metal contact occurs at the bolt pads. DO NOT exceed the “Maximum Allowable Bolt Torque” values specified in the table below for the applicable bolt/nut size. **NOTE:** For couplings shipped with a tag attached to the bolt pads, use only the Method 2 (Alternating Sides) assembly technique detailed below.

**METHOD 1:** Style 107V Coupling hardware may be tightened completely on one side before proceeding to the other side. It is the contractor’s responsibility to use this installation method ONLY for the Style 107V Coupling. All other Victaulic couplings shall be installed per the requirements published in their specific installation instructions.

**METHOD 2 (ALTERNATING SIDES):** As an alternative to Method 1, Style 107V Coupling hardware may be tightened evenly by alternating sides, maintaining nearly uniform bolt pad gaps, until metal-to-metal contact occurs at the bolt pads.

Verify that the oval neck of each bolt seats properly in the bolt holes. DO NOT continue to tighten the nuts after the visual, metal-to-metal bolt pad inspection requirement is achieved. **If you suspect that any hardware has been over-tightened (as indicated by a bend in the bolt, bulging of the nut at the bolt pad interface, or damage to the bolt pad, etc.), the entire coupling assembly shall be replaced immediately.**

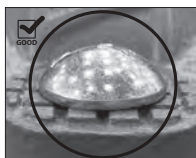

OVAL NECK OF BOLT  
SEATED PROPERLY



OVAL NECK OF BOLT  
NOT SEATED PROPERLY

### Helpful Information

Nominal Pipe Size inches/DN	Actual Pipe Outside Diameter inches/mm	Nut Size inches/ Metric	Deep-Well Socket Size inches/mm	Maximum Allowable Bolt Torque*
2 – 4 DN50 – DN100	2.375 – 4.500 60.3 – 114.3	½ M12	⅞ 22	135 ft-lbs 183 N•m
5	5.563 141.3	⅝ M16	1 ⅛ 27	235 ft-lbs 319 N•m
6 DN150	6.625 168.3	⅝ M16	1 ⅛ 27	235 ft-lbs 319 N•m
8 DN200	8.625 219.1	¾ M20	1 ¼ 32	365 ft-lbs 495 N•m
10 – 12 DN250 – DN300	10.528 – 12.750 267.4 – 323.9	⅞ M22	1 ⅞ 36	590 ft-lbs 800 N•m

\*Maximum allowable bolt torque values have been derived from actual test data

## **! WARNING**

- Visual inspection of each joint is required.
  - Improperly assembled joints shall be corrected before the system is filled, tested, or placed into service.
  - Any components that exhibit physical damage due to improper assembly shall be replaced before the system is filled, tested, or placed into service.
- Failure to follow these instructions could cause joint failure, resulting in death or serious personal injury and property damage.

6. Visually inspect each bolt pad location at every joint to verify that metal-to-metal contact is achieved.

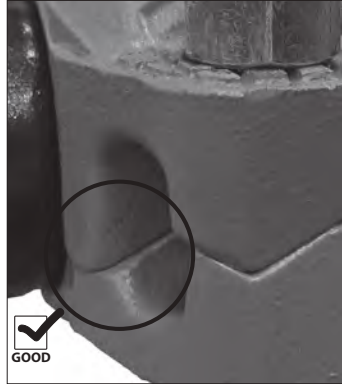
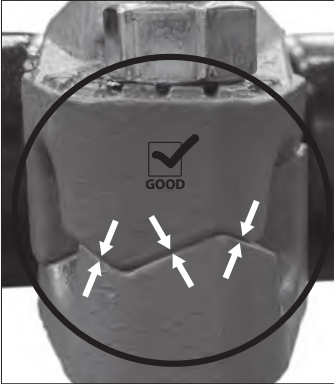

**PROPERLY ASSEMBLED JOINT – METAL-TO-METAL CONTACT AS INDICATED**

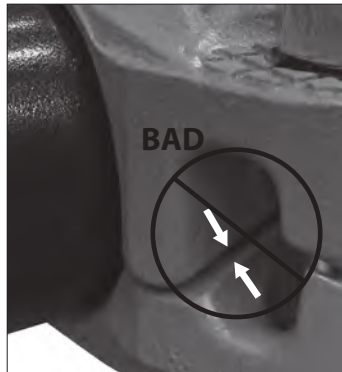
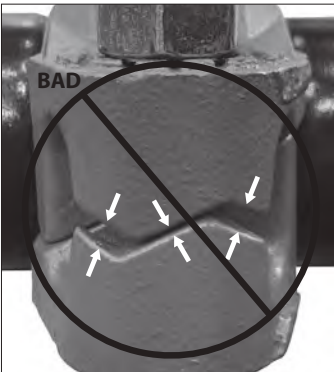

**IMPROPERLY ASSEMBLED JOINT – BOLT PAD GAP/UNDER-TIGHTENED**

Bolt pad gaps occur when the nuts are not tightened sufficiently. Refer to the "Impact Tool Usage Guidelines" and "Impact Tool Selection" sections in this handbook. These photos represent improper assemblies, which could result in joint failure, property damage, serious personal injury, or death.

**Style 107N** - QuickVic™ Installation-Ready™ Rigid Coupling

**Style 807N** - QuickVic™ Installation-Ready™ Rigid Coupling for Potable Water

## ! WARNING



- Read and understand all instructions before attempting to install any Victaulic products.
- Always verify that the piping system has been completely depressurized and drained immediately prior to installation, removal, adjustment, or maintenance of any Victaulic products.
- Confirm that any equipment, branch lines, or sections of piping that may have been isolated for/during testing or due to valve closures/positioning are identified, depressurized, and drained immediately prior to installation, removal, adjustment, or maintenance of any Victaulic products.
- These installation instructions are intended for an experienced, trained installer. The installer shall understand the use of this product and why it was specified for the particular application.
- The installer shall understand common industry safety standards and potential consequences of improper product installation.
- Wear safety glasses, hardhat, and foot protection.

Failure to follow these instructions could result in death or serious personal injury and property damage.

1. Follow all instructions in the “Preparatory Steps” section on pages 84 – 85.

OGS Roll Groove Profile Shown



*Pipe and groove are not shown to scale*

Style 107N and 807N Couplings shall be used ONLY with mating components that are prepared to Victaulic OGS groove specifications. **DO NOT** attempt to install these couplings on mating components that are prepared to any other groove specification.

## NOTICE

- The photos in this section show installation of a Style 107N Coupling; however, the same steps apply to installation of a Style 807N Coupling.

## ! WARNING

- Style 807N Couplings shall be installed only on stainless steel or galvanized carbon steel mating components that are prepared to Victaulic Original Groove System (OGS) Specifications.
- Refer to Victaulic publication 17.01 for stainless steel pipe preparation methods, which can be downloaded at [victaulic.com](http://victaulic.com).
- Victaulic RX grooving rolls shall be used for stainless steel pipe that is designated in Table 1 in Victaulic publication 17.01. Victaulic RX grooving rolls are silver in color and are identified by the “RX” marking on the face.

Failure to follow these instructions could cause joint failure, resulting in death or serious personal injury and property damage.

## ! WARNING



- Never leave a Style 107N or 807N Coupling partially assembled on mating component ends. **ALWAYS TIGHTEN THE HARDWARE IMMEDIATELY, IN ACCORDANCE WITH THESE INSTRUCTIONS.** A partially assembled coupling poses a drop or fall hazard during installation and a burst hazard during testing.



- Keep hands away from the mating component ends and the openings of the coupling when attempting to insert grooved mating component ends into the coupling.

- Keep hands away from coupling openings during tightening.

Failure to follow these instructions could result in death or serious personal injury and property damage.



**5. ASSEMBLE JOINT:** Assemble the joint by inserting the grooved end of a mating component into each opening of the coupling. The grooved mating component ends shall be inserted into the coupling until contact with the center leg of the gasket occurs.

A visual check is required to verify that the coupling keys align with the groove of each mating component and that the gasket is seated properly. **NOTE:** Prior to tightening the nuts, the coupling may be rotated to verify that the gasket is seated properly on the mating component ends and within the coupling housings.

### IMPORTANT INFORMATION FOR USE OF STYLE 107N AND 807N COUPLINGS WITH END CAPS AND FITTINGS:

## ! WARNING

- Always read and follow the “Victaulic End Cap Installation Safety Instructions” section in this handbook.

Failure to follow the “Victaulic End Cap Installation Safety Instructions” section could result in death or serious personal injury and property damage.

- When assembling Style 107N or 807N Couplings onto end caps, take additional time to inspect and verify that the end cap is seated fully against the center leg of the gasket.
- Use only Victaulic End Caps containing the “QV” or “EZ QV” marking on the inside face.
- Always confirm that any equipment, branch lines, or sections of piping that may have been isolated for/during testing or due to valve closures/positioning are identified, depressurized, and drained immediately prior to working with an end cap.
- Victaulic recommends the use of Victaulic fittings with Style 107N and 807N Couplings.

## ! WARNING

- Nuts shall be tightened evenly by alternating sides, maintaining nearly uniform bolt pad gaps, until metal-to-metal contact occurs at the angled bolt pads, as indicated in steps 6 and 7.
- Equal and positive or neutral offsets shall be present at the angled bolt pads, as indicated in steps 6 and 7.

Failure to tighten nuts as instructed will cause increased loading of the hardware, resulting in the following conditions:

- Excessive bolt torque required to assemble the joint (incomplete assembly)
- Damage to the assembled joint (damaged or broken bolt pads or fractures to housings)
- Bolt damage or fracture
- Joint leakage and property damage
- A negative impact on system integrity
- Personal injury or death

**DO NOT** continue to tighten the nuts after the visual, metal-to-metal bolt pad inspection requirement is achieved.

- Failure to follow this instruction could result in the conditions listed above.

## NOTICE

- It is important to tighten the nuts evenly by alternating sides to prevent gasket pinching.
- An impact tool or standard socket wrench with a deep-well socket can be used to bring the bolt pads into metal-to-metal contact.
- Refer to the “Impact Tool Usage Guidelines” and “Impact Tool Selection” sections in this handbook, along with the “Helpful Information” table on the following page.



**6. TIGHTEN NUTS:** Using an impact tool or a standard socket wrench with a deep-well socket, tighten the nuts evenly by alternating sides, maintaining nearly uniform bolt pad gaps, until metal-to-metal contact occurs at the angled bolt pads. Equal and positive or neutral offsets shall be present at the bolt pads. Verify that the oval neck of each bolt seats properly in the bolt holes. **DO NOT** continue to tighten the nuts after the visual, metal-to-metal bolt pad inspection requirement is achieved. **If you suspect that any hardware has been over-tightened (as indicated by a bend in the bolt, bulging of the nut at the bolt pad interface, or damage to the bolt pad, etc.), the entire coupling assembly shall be replaced immediately.** Refer to the “Impact Tool Usage Guidelines” and “Impact Tool Selection” sections in this handbook, along with the “Helpful Information” table on the following page.

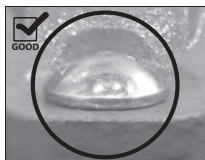

OVAL NECK OF BOLT SEATED PROPERLY



OVAL NECK OF BOLT NOT SEATED PROPERLY

## Helpful Information

Nominal Pipe Size inches/DN	Actual Pipe Outside Diameter inches/mm	Nut Size inches/Metric	Deep-Well Socket Size inches/mm	Maximum Allowable Bolt Torque*
2 – 4 DN50 – DN100	2.375 – 4.500 60.3 – 114.3	½ M12	⅞ 22	135 ft-lbs 183 N•m
	5.250 133.0	⅝ M16	1 ⅛ 27	235 ft-lbs 319 N•m
DN125	5.500 139.7	⅝ M16	1 ⅛ 27	235 ft-lbs 319 N•m
5	5.563 141.3	⅝ M16	1 ⅛ 27	235 ft-lbs 319 N•m
	6.250 – 6.500 159.0 – 165.1	⅝ M16	1 ⅛ 27	235 ft-lbs 319 N•m
6 DN150	6.625 168.3	⅝ M16	1 ⅛ 27	235 ft-lbs 319 N•m
	8.515 216.3	¾ M20	1 ¼ 32	425 ft-lbs 576 N•m
8 DN200	8.625 219.1	¾ M20	1 ¼ 32	425 ft-lbs 576 N•m
10 – 12 DN250 – DN300	10.528 – 12.750 267.4 – 323.9	⅞ M22	1 ⅞ 36	675 ft-lbs 915 N•m

\*Maximum allowable bolt torque values have been derived from actual test data  
NOTE: The Style 807N Coupling may not be available in all sizes listed in this table

### **!** WARNING

- Visual inspection of each joint is required.
  - Improperly assembled joints shall be corrected before the system is filled, tested, or placed into service.
  - Any components that exhibit physical damage due to improper assembly shall be replaced before the system is filled, tested, or placed into service.
- Failure to follow these instructions could cause joint failure, resulting in death or serious personal injury and property damage.

7. Visually inspect each bolt pad location at every joint to verify that metal-to-metal contact is achieved across the entire bolt pad section. Equal and positive or neutral offsets shall be present at each bolt pad location.

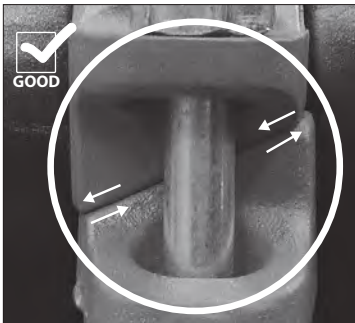

**PROPERLY ASSEMBLED JOINT  
METAL-TO-METAL CONTACT AT ANGLED  
BOLT PADS WITH EQUAL, POSITIVE  
OFFSETS AT THE BOLT PADS**

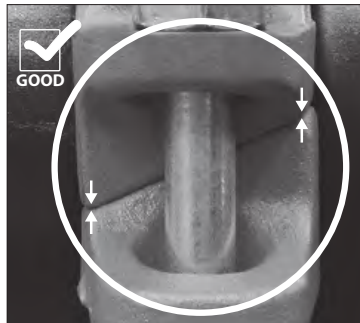

**PROPERLY ASSEMBLED JOINT  
METAL-TO-METAL CONTACT AT ANGLED  
BOLT PADS WITH EQUAL, NEUTRAL  
OFFSETS AT THE BOLT PADS**



**IMPROPERLY ASSEMBLED JOINT  
BOLT PAD GAP**

Bolt pad gaps occur when the nuts are not tightened sufficiently or if the hardware is not tightened evenly by alternating sides. Refer to the “Improperly Assembled Joint – Over-Shifted” section below. In addition, refer to the “Impact Tool Usage Guidelines” and “Impact Tool Selection” sections in this handbook.

This represents an improper assembly, which could result in joint failure, property damage, serious personal injury, or death.

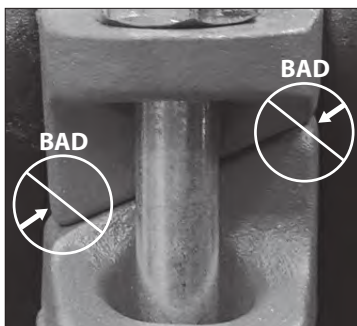

**IMPROPERLY ASSEMBLED JOINT  
NEGATIVE OFFSET**

Negative bolt pad offsets occur when the nuts are not tightened evenly, which produces over-tightening of one side and under-tightening of the other side. In addition, negative offsets occur if both nuts are under-tightened. Refer to the “Impact Tool Usage Guidelines” and “Impact Tool Selection” sections in this handbook. This represents an improper assembly, which could result in joint failure, property damage, serious personal injury, or death.

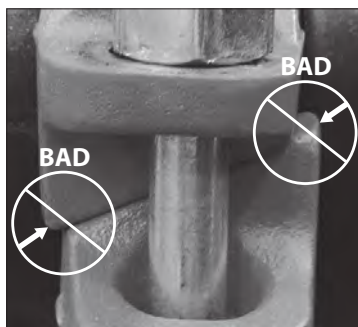

**IMPROPERLY ASSEMBLED JOINT  
OVER-SHIFTED**

Over-shifting of an angled bolt pad results in an offset that prevents metal-to-metal contact and equal and positive or neutral offset at the opposite angled bolt pad.

This occurs when the hardware is not tightened evenly by alternating sides. Attempting to tighten the hardware on one side while the other side is over-shifted will result in bolt torque that exceeds the “Maximum Allowable Bolt Torque” values specified in the “Helpful Information” table in this section. Refer to the “Impact Tool Usage Guidelines” and “Impact Tool Selection” sections in this handbook.

This represents an improper assembly, which could result in joint failure, property damage, serious personal injury, or death.

**! WARNING**



- Read and understand all instructions before attempting to install any Victaulic products.
- Always verify that the piping system has been completely depressurized and drained immediately prior to installation, removal, adjustment, or maintenance of any Victaulic products.
- Confirm that any equipment, branch lines, or sections of piping that may have been isolated for/during testing or due to valve closures/positioning are identified, depressurized, and drained immediately prior to installation, removal, adjustment, or maintenance of any Victaulic products.
- Wear safety glasses, hardhat, and foot protection.
- Style 115 Victaulic® FireLock EZ™ Installation-Ready™ Reducing Couplings shall be used only in fire protection systems that are designed and installed in accordance with current, applicable National Fire Protection Association (NFPA 13, 13D, 13R, etc.) standards, or equivalent standards, and in accordance with applicable building and fire codes. These standards and codes contain important information regarding protection of systems from freezing temperatures, corrosion, mechanical damage, etc.
- These installation instructions are intended for an experienced, trained installer. The installer shall understand the use of this product and why it was specified for the particular application.
- The installer shall understand common industry safety standards and potential consequences of improper product installation.

Failure to follow installation requirements and local and national codes and standards could compromise system integrity or cause system failure, resulting in death or serious personal injury and property damage.

1. Follow all instructions in the “Preparatory Steps” section on pages 84 – 85.

IGS Groove Profile for  
1-inch/DN25 Side of Coupling



Original Groove System (OGS) Groove Profile for  
1¼-inch/DN32 or 1½-inch/DN40 Side of Coupling



*Pipe and groove are not shown to scale*

The 1-inch/DN25 side of Style 115 Couplings shall be used **ONLY** with mating components that are prepared to Victaulic IGS proprietary groove specifications. **DO NOT** attempt to install the 1-inch/DN25 side on mating components that are prepared to any other groove specification.

The 1¼-inch/DN32 or 1½-inch/DN40 side of Style 115 Couplings shall be used **ONLY** with mating components that are prepared to Victaulic OGS groove specifications. **DO NOT** attempt to install the 1¼-inch/DN32 or 1½-inch/DN40 side on mating components that are prepared to any other groove specification.



**NOTICE**

- When stainless steel hardware is special ordered, the bolt head will contain a “316” mark, as shown to the left.

## ! WARNING



- Never leave a Style 115 Coupling partially assembled on mating component ends. **ALWAYS TIGHTEN THE HARDWARE IMMEDIATELY, IN ACCORDANCE WITH THESE INSTRUCTIONS.** A partially assembled coupling poses a drop or fall hazard during installation and a burst hazard during testing.



- Keep hands away from the mating component ends and the openings of the coupling when attempting to insert grooved mating component ends into the coupling.
  - Keep hands away from coupling openings during tightening.
- Failure to follow these instructions could result in death or serious personal injury and property damage.



- 4. ASSEMBLE JOINT:** Assemble the joint by inserting the grooved end of a mating component into the corresponding size opening of the coupling. The grooved mating component ends shall be inserted into the coupling until contact with the center leg of the gasket occurs.

A visual check is required to verify that the coupling keys align with the groove of each mating component and that the gasket is seated properly. **NOTE:** Prior to tightening the nuts, the coupling may be rotated to verify that the gasket is seated properly on the mating component ends and within the coupling housings.

### IMPORTANT INFORMATION FOR USE OF STYLE 115 COUPLINGS WITH END CAPS AND FITTINGS:

## ! WARNING

- Always read and follow the “Victaulic End Cap Installation Safety Instructions” section in this handbook.
  - For the 1-inch/DN25 IGS side, the FireLock™ No. 146 End Cap **SHALL NOT** be used directly with the Style 115 Coupling. Refer to further instructions below.
- Failure to follow the “Victaulic End Cap Installation Safety Instructions” section could result in death or serious personal injury and property damage.

- For the 1-inch/DN25 IGS side, the FireLock™ No. 146 End Cap **SHALL NOT** be used directly with the Style 115 Coupling. In this case, a spool piece with both ends prepared to 1-inch/DN25 IGS dimensions and a Style 108 Coupling are required between the Style 115 Coupling and No. 146 End Cap.
- For the 1 ¼-inch/DN32 or 1 ½-inch/DN40 side, use only Victaulic FireLock No. 006 End Caps containing the “EZ” marking on the inside face or Victaulic End Caps containing the “QV” or “EZ QV” marking on the inside face.
- When assembling Style 115 Couplings onto end caps, take additional time to inspect and verify that the end cap is seated fully against the center leg of the gasket.
- Always confirm that any equipment, branch lines, or sections of piping that may have been isolated for/during testing or due to valve closures/positioning are identified, depressurized, and drained immediately prior to working with an end cap.
- Victaulic recommends the use of Victaulic fittings with Style 115 Couplings.

## ! WARNING

- Nuts shall be tightened evenly by alternating sides, maintaining nearly uniform bolt pad gaps, until metal-to-metal contact occurs at the angled bolt pads, as indicated in steps 5 and 6.
- Equal and positive or neutral offsets shall be present at the angled bolt pads, as indicated in steps 5 and 6.

Failure to tighten nuts as instructed will cause increased loading of the hardware, resulting in the following conditions:

- Excessive bolt torque required to assemble the joint (incomplete assembly)
- Damage to the assembled joint (damaged or broken bolt pads or fractures to housings)
- Bolt damage or fracture
- Joint leakage and property damage
- A negative impact on system integrity
- Personal injury or death

**DO NOT** continue to tighten the nuts after the visual, metal-to-metal bolt pad inspection requirement is achieved.

- Failure to follow this instruction could result in the conditions listed above.

## NOTICE

- It is important to tighten the nuts evenly by alternating sides to prevent gasket pinching.
- An impact tool or standard socket wrench with a deep-well socket can be used to bring the bolt pads into metal-to-metal contact.
- Refer to the “Impact Tool Usage Guidelines” and “Impact Tool Selection” sections in this handbook.



**5. TIGHTEN NUTS:** Using an impact tool or a standard socket wrench with an  $\frac{1}{4}$ -inch (for Imperial nuts)/17-mm (for Metric nuts) deep-well socket, tighten the nuts evenly by alternating sides, maintaining nearly uniform bolt pad gaps, until metal-to-metal contact occurs at the angled bolt pads. Equal and positive or neutral offsets shall be present at the bolt pads. **MAXIMUM ALLOWABLE BOLT TORQUE IS 55 ft-lbs/75 N•m.** Verify that the oval neck of each bolt seats properly in the bolt holes. **DO NOT** continue to tighten the nuts after the visual, metal-to-metal bolt pad inspection requirement is achieved. **If you suspect that any hardware has been over-tightened (as indicated by a bend in the bolt, bulging of the nut at the bolt pad interface, or damage to the bolt pad, etc.), the entire coupling assembly shall be replaced immediately.** Refer to the “Impact Tool Usage Guidelines” and “Impact Tool Selection” sections in this handbook.

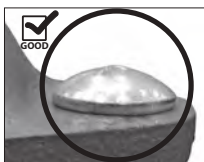

OVAL NECK OF BOLT SEATED PROPERLY



OVAL NECK OF BOLT NOT SEATED PROPERLY

## WARNING

- Visual inspection of each joint is required.
  - Improperly assembled joints shall be corrected before the system is filled, tested, or placed into service.
  - Any components that exhibit physical damage due to improper assembly shall be replaced before the system is filled, tested, or placed into service.
- Failure to follow these instructions could cause joint failure, resulting in death or serious personal injury and property damage.

6. Visually inspect each bolt pad location at every joint to verify that metal-to-metal contact is achieved across the entire bolt pad section. Equal and positive or neutral offsets shall be present at each bolt pad location.

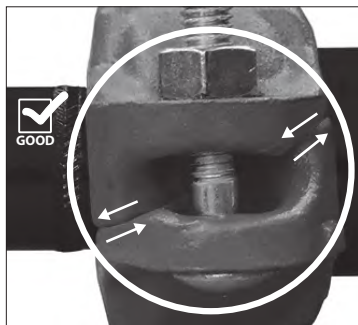

**PROPERLY ASSEMBLED JOINT  
METAL-TO-METAL CONTACT AT ANGLED  
BOLT PADS WITH EQUAL, POSITIVE  
OFFSETS AT THE BOLT PADS**

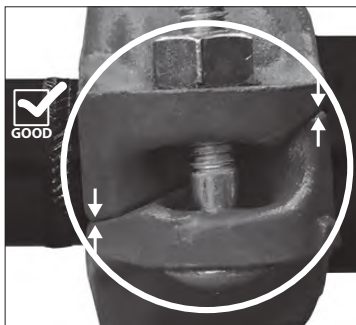

**PROPERLY ASSEMBLED JOINT  
METAL-TO-METAL CONTACT AT ANGLED  
BOLT PADS WITH EQUAL, NEUTRAL  
OFFSETS AT THE BOLT PADS**

*Continued on the following page*

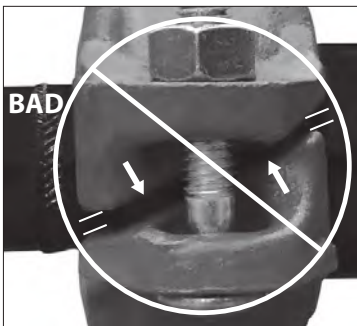

**IMPROPERLY ASSEMBLED JOINT  
BOLT PAD GAP**

Bolt pad gaps occur when the nuts are not tightened sufficiently or if the hardware is not tightened evenly by alternating sides. Refer to the “Improperly Assembled Joint – Over-Shifted” section below. In addition, refer to the “Impact Tool Usage Guidelines” and “Impact Tool Selection” sections in this handbook.

This represents an improper assembly, which could result in joint failure, property damage, serious personal injury, or death.

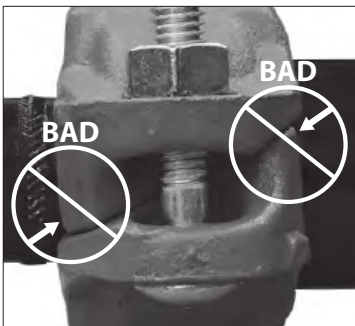

**IMPROPERLY ASSEMBLED JOINT  
NEGATIVE OFFSET**

Negative bolt pad offsets occur when the nuts are not tightened evenly, which produces over-tightening of one side and under-tightening of the other side. In addition, negative offsets occur if both nuts are under-tightened. Refer to the “Impact Tool Usage Guidelines” and “Impact Tool Selection” sections in this handbook. This represents an improper assembly, which could result in joint failure, property damage, serious personal injury, or death.

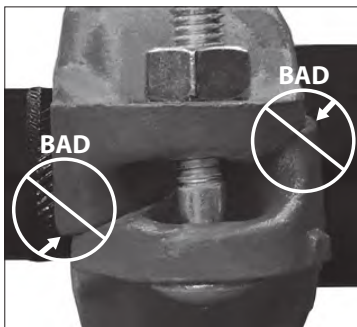







**IMPROPERLY ASSEMBLED JOINT  
OVER-SHIFTED**

Over-shifting of an angled bolt pad results in an offset that prevents metal-to-metal contact and equal and positive or neutral offset at the opposite angled bolt pad.

This occurs when the hardware is not tightened evenly by alternating sides.

Attempting to tighten the hardware on one side while the other side is over-shifted will result in bolt torque that exceeds the “Maximum Allowable Bolt Torque” values specified in the “Helpful Information” table in this section. Refer to the “Impact Tool Usage Guidelines” and “Impact Tool Selection” sections in this handbook.

This represents an improper assembly, which could result in joint failure, property damage, serious personal injury, or death.

 <b>WARNING</b>				
				
<ul style="list-style-type: none"> <li>• Read and understand all instructions before attempting to install any Victaulic products.</li> <li>• Always verify that the piping system has been completely depressurized and drained immediately prior to installation, removal, adjustment, or maintenance of any Victaulic products.</li> <li>• Confirm that any equipment, branch lines, or sections of piping that may have been isolated for/during testing or due to valve closures/positioning are identified, depressurized, and drained immediately prior to installation, removal, adjustment, or maintenance of any Victaulic products.</li> <li>• These installation instructions are intended for an experienced, trained installer. The installer shall understand the use of this product and why it was specified for the particular application.</li> <li>• The installer shall understand common industry safety standards and potential consequences of improper product installation.</li> <li>• Wear safety glasses, hardhat, and foot protection.</li> </ul> <p>Failure to follow these instructions could result in death or serious personal injury and property damage.</p>				

1. Follow all instructions in the “Preparatory Steps” section on pages 84 – 85.

OGS Roll Groove Profile Shown



*Pipe and groove are not shown to scale*

Style 171 Couplings shall be used ONLY with mating components that are prepared to Victaulic OGS groove specifications. **DO NOT** attempt to install these couplings on mating components that are prepared to any other groove specification.

 <b>WARNING</b>	
	<ul style="list-style-type: none"> <li>• Never leave a Style 171 Coupling partially assembled on mating component ends. <b>ALWAYS TIGHTEN THE HARDWARE IMMEDIATELY, IN ACCORDANCE WITH THESE INSTRUCTIONS.</b> A partially assembled coupling poses a drop or fall hazard during installation and a burst hazard during testing.</li> <li>• Keep hands away from the mating component ends and the openings of the coupling when attempting to insert grooved mating component ends into the coupling.</li> <li>• Keep hands away from coupling openings during tightening.</li> </ul> <p>Failure to follow these instructions could result in death or serious personal injury and property damage.</p>
	



**5. INSTALL COUPLING OVER MATING**

**COMPONENT END:** Install the coupling over the grooved mating component end. Verify that the coupling and gasket do not overhang the mating component end.



**6. JOIN MATING COMPONENTS:** Align the centerlines of the two grooved mating component ends. Slide the coupling into position so that the coupling keys align with the groove of each mating component.

A visual check is required to verify that the coupling keys align with the groove of each mating component and that the gasket is seated properly. **NOTE:** Prior to tightening the nuts, the coupling may be rotated to verify that the gasket is seated properly on the mating component ends and within the coupling housings.

#### **IMPORTANT INFORMATION FOR USE OF STYLE 171 COUPLINGS WITH END CAPS AND FITTINGS:**

### **! WARNING**

- Always read and follow the “Victaulic End Cap Installation Safety Instructions” section in this handbook.

Failure to follow the “Victaulic End Cap Installation Safety Instructions” section could result in death or serious personal injury and property damage.

- When assembling Style 171 Couplings onto end caps, take additional time to inspect and verify that the end cap is seated fully in the coupling.
- Always confirm that any equipment, branch lines, or sections of piping that may have been isolated for/during testing or due to valve closures/positioning are identified, depressurized, and drained immediately prior to working with an end cap.
- Victaulic recommends the use of Victaulic fittings with Style 171 Couplings.

### **! WARNING**

- Nuts shall be tightened evenly by alternating sides, maintaining nearly uniform bolt pad gaps, until full bolt-pad to bolt-pad contact occurs, as indicated in steps 7 and 8.

Failure to tighten nuts as instructed will cause increased loading of the hardware, resulting in the following conditions:

- Excessive bolt torque required to assemble the joint (incomplete assembly)
- Damage to the assembled joint (damaged or broken bolt pads or fractures to housings)
- Bolt damage or fracture
- Joint leakage and property damage
- A negative impact on system integrity
- Personal injury or death

**DO NOT** continue to tighten the nuts after the visual, bolt-pad to bolt-pad inspection requirement is achieved.

- Failure to follow this instruction could result in the conditions listed above.

### **NOTICE**

- It is important to tighten the nuts evenly by alternating sides to prevent gasket pinching.
- An impact tool or standard socket wrench with a deep-well socket can be used to bring the bolt pads into contact.
- Refer to the “Impact Tool Usage Guidelines” and “Impact Tool Selection” sections in this handbook, along with the “Helpful Information” table on the following page.



**7. TIGHTEN NUTS:** Using an impact tool or a standard socket wrench with a deep-well socket, tighten the nuts evenly by alternating sides, maintaining nearly uniform bolt pad gaps, until full bolt-pad to bolt-pad contact occurs. Verify that the oval neck of each bolt seats properly in the bolt holes. **DO NOT** continue to tighten the nuts after the visual, bolt-pad to bolt-pad inspection requirement is achieved, and **DO NOT** exceed 60 ft-lbs/81 N•m of torque on the nuts during assembly. **If you suspect that any hardware has been over-tightened (as indicated by damage to the bolt pad, etc.), the entire coupling assembly shall be replaced immediately.** Refer to the “Impact Tool Usage Guidelines” and “Impact Tool Selection” sections in this handbook, along with the “Helpful Information” table below.

OVAL NECK  
OF BOLT  
SEATED  
PROPERLY



OVAL NECK  
OF BOLT  
NOT  
SEATED  
PROPERLY



### Helpful Information

Nominal Pipe Size inches/DN	Actual Pipe Outside Diameter inches/mm	Nut Size inches/Metric	Deep-Well Socket Size inches/mm	Maximum Allowable Bolt Torque*
1 ½ – 2 DN40 – DN50	1.900 – 2.375 48.3 – 60.3	¾ M10	1¼ 17	60 ft-lbs 81 N•m
2 ½	2.875 73.0	¾ M10	1¼ 17	60 ft-lbs 81 N•m
3 – 4 DN80 – DN100	3.500 – 4.500 88.9 – 114.3	½ M12	¾ 22	60 ft-lbs 81 N•m

\*Maximum allowable bolt torque values have been derived from actual test data

### ! WARNING

- Visual inspection of each joint is required.
- Improperly assembled joints shall be corrected before the system is filled, tested, or placed into service.
- Any components that exhibit physical damage due to improper assembly shall be replaced before the system is filled, tested, or placed into service.

Failure to follow these instructions could cause joint failure, resulting in death or serious personal injury and property damage.

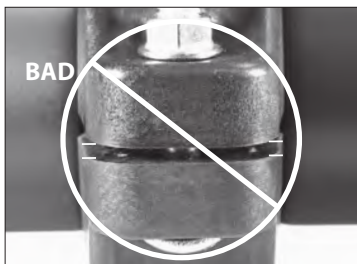
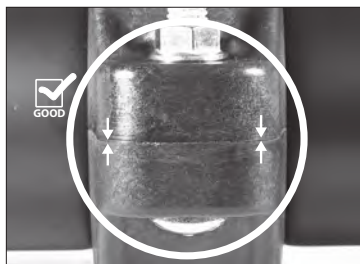

**8. Visually inspect each bolt pad location at every joint to verify that full bolt-pad to bolt-pad contact is achieved across the entire bolt pad section.**

Style 177N - QuickVic™ Installation-Ready™ Flexible Coupling

Style 877N - QuickVic™ Installation-Ready™ Flexible Coupling for Potable Water

## WARNING



- Read and understand all instructions before attempting to install any Victaulic products.
- Always verify that the piping system has been completely depressurized and drained immediately prior to installation, removal, adjustment, or maintenance of any Victaulic products.
- Confirm that any equipment, branch lines, or sections of piping that may have been isolated for/during testing or due to valve closures/positioning are identified, depressurized, and drained immediately prior to installation, removal, adjustment, or maintenance of any Victaulic products.
- These installation instructions are intended for an experienced, trained installer. The installer shall understand the use of this product and why it was specified for the particular application.
- The installer shall understand common industry safety standards and potential consequences of improper product installation.
- Wear safety glasses, hardhat, and foot protection.

Failure to follow these instructions could result in death or serious personal injury and property damage.

1. Follow all instructions in the “Preparatory Steps” section on pages 84 – 85.

OGS Roll Groove Profile Shown



*Pipe and groove are not shown to scale*

Style 177N and 877N Couplings shall be used **ONLY** with mating components that are prepared to Victaulic OGS groove specifications. **DO NOT** attempt to install these couplings on mating components that are prepared to any other groove specification.

## NOTICE

- The photos in this section show installation of a Style 177N Coupling; however, the same steps apply to installation of a Style 877N Coupling.

## WARNING

- Style 877N Couplings shall be installed only on stainless steel or galvanized carbon steel mating components that are prepared to Victaulic Original Groove System (OGS) Specifications.
- Refer to Victaulic publication 17.01 for stainless steel pipe preparation methods, which can be downloaded at [victaulic.com](http://victaulic.com).
- Victaulic RX grooving rolls shall be used for stainless steel pipe that is designated in Table 1 in Victaulic publication 17.01. Victaulic RX grooving rolls are silver in color and are identified by the “RX” marking on the face.

Failure to follow these instructions could cause joint failure, resulting in death or serious personal injury and property damage.

## ! WARNING



- Never leave a Style 177N or 877N Coupling partially assembled on mating component ends. **ALWAYS TIGHTEN THE HARDWARE IMMEDIATELY, IN ACCORDANCE WITH THESE INSTRUCTIONS.** A partially assembled coupling poses a drop or fall hazard during installation and a burst hazard during testing.
  - Keep hands away from the mating component ends and the openings of the coupling when attempting to insert grooved mating component ends into the coupling.
  - Keep hands away from coupling openings during tightening.
- Failure to follow these instructions could result in death or serious personal injury and property damage.



**5. ASSEMBLE JOINT:** Assemble the joint by inserting the grooved end of a mating component into each opening of the coupling. The grooved mating component ends shall be inserted into the coupling until contact with the center leg of the gasket occurs.

A visual check is required to verify that the coupling keys align with the groove of each mating component and that the gasket is seated properly. **NOTE:** Prior to tightening the nuts, the coupling may be rotated to verify that the gasket is seated properly on the mating component ends and within the coupling housings.

### IMPORTANT INFORMATION FOR USE OF STYLE 177N AND 877N COUPLINGS WITH END CAPS AND FITTINGS:

## ! WARNING

- Always read and follow the “Victaulic End Cap Installation Safety Instructions” section in this handbook.

Failure to follow the “Victaulic End Cap Installation Safety Instructions” section could result in death or serious personal injury and property damage.

- When assembling Style 177N or 877N Couplings onto end caps, take additional time to inspect and verify that the end cap is seated fully against the center leg of the gasket.
- Use only Victaulic End Caps containing the “QV” or “EZ QV” marking on the inside face.
- Always confirm that any equipment, branch lines, or sections of piping that may have been isolated for/during testing or due to valve closures/positioning are identified, depressurized, and drained immediately prior to working with an end cap.
- Victaulic recommends the use of Victaulic fittings with Style 177N and 877N Couplings.

## ! WARNING

- Nuts shall be tightened evenly by alternating sides, maintaining nearly uniform bolt pad gaps, until metal-to-metal contact occurs at the bolt pads, as indicated in steps 6 and 7.

Failure to tighten nuts as instructed will cause increased loading of the hardware, resulting in the following conditions:

- Excessive bolt torque required to assemble the joint (incomplete assembly)
- Damage to the assembled joint (damaged or broken bolt pads or fractures to housings)
- Bolt damage or fracture
- Joint leakage and property damage
- A negative impact on system integrity
- Personal injury or death

**DO NOT** continue to tighten the nuts after the visual, metal-to-metal bolt pad inspection requirement is achieved.

- Failure to follow this instruction could result in the conditions listed above.

## NOTICE

- It is important to tighten the nuts evenly by alternating sides to prevent gasket pinching.
- An impact tool or standard socket wrench with a deep-well socket can be used to bring the bolt pads into metal-to-metal contact.
- Refer to the “Impact Tool Usage Guidelines” and “Impact Tool Selection” sections in this handbook, along with the “Helpful Information” table on the following page.



**6. TIGHTEN NUTS:** Using an impact tool or a standard socket wrench with a deep-well socket, tighten the nuts evenly by alternating sides, maintaining nearly uniform bolt pad gaps, until metal-to-metal contact occurs at the bolt pads. Verify that the oval neck of each bolt seats properly in the bolt holes. **DO NOT** continue to tighten the nuts after the visual, metal-to-metal bolt pad inspection requirement is achieved. **If you suspect that any hardware has been over-tightened (as indicated by a bend in the bolt, bulging of the nut at the bolt pad interface, or damage to the bolt pad, etc.), the entire coupling assembly shall be replaced immediately.** Refer to the “Impact Tool Usage Guidelines” and “Impact Tool Selection” sections in this handbook, along with the “Helpful Information” table on the following page.

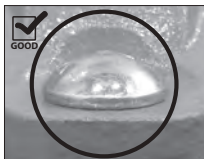

OVAL NECK OF BOLT  
SEATED PROPERLY



OVAL NECK OF BOLT  
NOT SEATED PROPERLY

## Helpful Information

Nominal Pipe Size inches/DN	Actual Pipe Outside Diameter inches/mm	Nut Size inches/Metric	Deep-Well Socket Size inches/mm	Maximum Allowable Bolt Torque*
2 – 3 DN50 – DN80	2.375 – 3.500 60.3 – 88.9	½ M12	⅞ 22	135 ft-lbs 183 N•m
	4.250 108.0	⅝ M16	1 ⅛ 27	235 ft-lbs 319 N•m
4 DN100	4.500 114.3	⅝ M16	1 ⅛ 27	235 ft-lbs 319 N•m
	5.250 133.0	¾ M20	1 ¼ 32	425 ft-lbs 576 N•m
	5.500 139.7	¾ M20	1 ¼ 32	425 ft-lbs 576 N•m
DN125	5.500 139.7	¾ M20	1 ¼ 32	425 ft-lbs 576 N•m
5	5.563 141.3	¾ M20	1 ¼ 32	425 ft-lbs 576 N•m
	6.250 – 6.500 159.0 – 165.1	¾ M20	1 ¼ 32	425 ft-lbs 576 N•m
6 DN150	6.625 168.3	¾ M20	1 ¼ 32	425 ft-lbs 576 N•m
8 DN200	8.625 219.1	⅞ M22	1 ⅞ 36	675 ft-lbs 915 N•m

\*Maximum allowable bolt torque values have been derived from actual test data  
NOTE: The Style 877N may not be available in all sizes listed in this table

### WARNING

- Visual inspection of each joint is required.
- Improperly assembled joints shall be corrected before the system is filled, tested, or placed into service.
- Any components that exhibit physical damage due to improper assembly shall be replaced before the system is filled, tested, or placed into service.

Failure to follow these instructions could cause joint failure, resulting in death or serious personal injury and property damage.

7. Visually inspect each bolt pad location at every joint to verify that metal-to-metal contact is achieved across the entire bolt pad section.

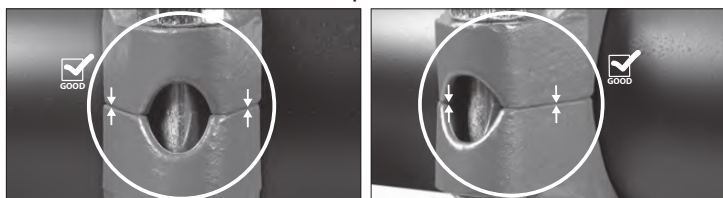

PROPERLY ASSEMBLED JOINT – METAL-TO-METAL CONTACT AS INDICATED

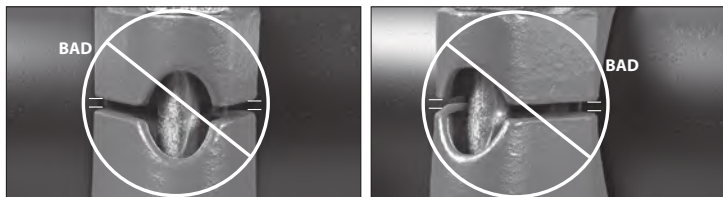

IMPROPERLY ASSEMBLED JOINT – BOLT PAD GAP/UNDER-TIGHTENED

Bolt pad gaps occur when the nuts are not tightened sufficiently. Refer to the “Impact Tool Usage Guidelines” section. These photos represent improper assemblies, which could result in joint failure, property damage, serious personal injury, or death.

# INSTRUCTIONS FOR REASSEMBLY OF STYLE 009N, 107V, 107N, AND 807N COUPLINGS

## ! WARNING



- Always verify that the piping system has been completely depressurized and drained immediately prior to installation, removal, adjustment, or maintenance of any Victaulic products.

- Confirm that any equipment, branch lines, or sections of piping that may have been isolated for/during testing or due to valve closures/positioning are identified, depressurized, and drained immediately prior to installation, removal, adjustment, or maintenance of any Victaulic products.
- Failure to follow this instruction could result in death or serious personal injury and property damage.

## NOTICE



Two methods can be followed for reassembly of Style 009N, 107V, 107N, and 807N Couplings.

- **METHOD 1 FOR REASSEMBLY:** The coupling can be reassembled into its “installation-ready” condition by installing the gasket into the housings, then inserting the bolts and threading a nut onto each bolt until 2 – 3 threads are exposed, as shown to the left. If this method is chosen, steps 1 – 5 on this page, along with the tightening sequence steps described in the applicable coupling installation instructions on the previous pages, shall be followed.
- OR
- **METHOD 2 FOR REASSEMBLY:** The gasket and housings can be assembled onto the mating component ends by following steps 1 – 5 on this page, along with all steps in the “Method 2 for Reassembly” section on the following page.

Follow these five steps for Method 1 or Method 2:

1. Verify that the system is depressurized and drained completely before attempting to disassemble any couplings.
2. Loosen the nuts of the coupling assembly to permit removal of the coupling from the mating component ends.
3. Remove the nuts, bolts, and gasket from the housings. Inspect all components for any damage or wear. If any damage or wear is present, use a new Victaulic-supplied coupling assembly.
4. Check mating component ends, as described in the applicable coupling installation instructions on the previous pages.

## ! CAUTION

- A thin coat of a compatible lubricant shall be used to help prevent the gasket from pinching, rolling, or tearing during reassembly.
  - DO NOT use excessive lubricant on the gasket sealing lips and exterior.
- Failure to use a compatible lubricant may cause gasket damage, resulting in joint leakage and property damage.



5. **FOR REASSEMBLY OF STYLE 009N, 107V, 107N, AND 807N COUPLINGS, LUBRICATE GASKET:** Apply a thin coat of a compatible lubricant to the gasket sealing lips and exterior. Refer to the “Lubricant Compatibility for Gaskets” table on page 34.

## Method 2 for Reassembly

### NOTICE

- The photos in this section show reassembly of a Style 107V Coupling; however, the same steps apply to reassembly of a Style 009N, 107N, and 807N Coupling.

1. Verify that steps 1 – 5 on the previous page have been followed.

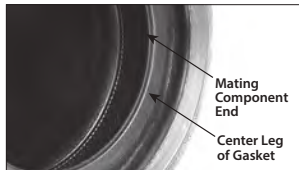

**2. INSTALL GASKET:** Insert the grooved end of a mating component into the gasket until it contacts the center leg of the gasket.



**3. JOIN MATING COMPONENTS:** Align the centerlines of the two grooved mating component ends. Insert the other mating component end into the gasket until it contacts the center leg of the gasket. **NOTE:** Verify that no portion of the gasket extends into the groove of either mating component.



**4. TO FACILITATE REASSEMBLY:** One bolt can be inserted into the housings with the nut threaded loosely onto the bolt to allow for the "swing-over" feature, as shown. **NOTE:** The nut should be threaded no further than flush with the end of the bolt.

### ! CAUTION

- Verify that the gasket does not become rolled or pinched while installing the housings.

Failure to follow this instruction could cause gasket damage, resulting in joint leakage.



**5. INSTALL HOUSINGS:** Install the housings over the gasket. Verify that the housings' keys engage the grooves completely on both mating components.



**6. INSTALL REMAINING BOLT/NUT:** Install the remaining bolt, and thread the nut finger-tight onto the bolt. **NOTE:** Verify that the oval neck of each bolt seats properly in the bolt hole.

**7. TIGHTEN NUTS:** To complete the assembly, follow the tightening sequence described in the applicable coupling installation instructions on the previous pages.

# INSTRUCTIONS FOR REASSEMBLY OF STYLE 115 COUPLINGS

## WARNING



- Always verify that the piping system has been completely depressurized and drained immediately prior to installation, removal, adjustment, or maintenance of any Victaulic products.

- Confirm that any equipment, branch lines, or sections of piping that may have been isolated for/during testing or due to valve closures/positioning are identified, depressurized, and drained immediately prior to installation, removal, adjustment, or maintenance of any Victaulic products.

Failure to follow this instruction could result in death or serious personal injury and property damage.

## NOTICE

Two methods can be followed for reassembly of  
Style 115 Couplings.



- **METHOD 1 FOR REASSEMBLY:** The coupling can be reassembled into its “installation-ready” condition by installing the gasket into the housings, then inserting the bolts and threading a nut onto each bolt until 2 – 3 threads are exposed, as shown to the left. Verify that the smaller opening of the gasket is facing toward the smaller opening of the housings. If this method is chosen, steps 1 – 5 on this page, along with all steps on pages 105 – 108, shall be followed.

OR

- **METHOD 2 FOR REASSEMBLY:** The gasket and housings can be assembled onto the mating component ends by following steps 1 – 5 on this page, along with all steps in the “Method 2 for Reassembly” section on the following page.

Follow these five steps for Method 1 or Method 2:

1. Verify that the system is depressurized and drained completely before attempting to disassemble any couplings.
2. Loosen the nuts of the coupling assembly to permit removal of the coupling from the mating component ends.
3. Remove the nuts, bolts, and gasket from the housings. Inspect all components for any damage or wear. If any damage or wear is present, use a new Victaulic-supplied coupling assembly.
4. Check mating component ends, as described in step 2 on page 85.

## CAUTION

- A thin coat of a compatible lubricant shall be used to help prevent the gasket from pinching, rolling, or tearing during reassembly.
  - **DO NOT** use excessive lubricant on the gasket sealing lips and exterior.
- Failure to use a compatible lubricant may cause gasket damage, resulting in joint leakage and property damage.



5. **FOR REASSEMBLY, LUBRICATE GASKET:** Apply a thin coat of a compatible lubricant to the surfaces of the gasket shown above. Refer to the “Lubricant Compatibility for Gaskets” table on page 34.

## Method 2 for Reassembly

1. Verify that steps 1 – 5 in the “Instructions for Reassembly of Style 115 Couplings” section have been followed.

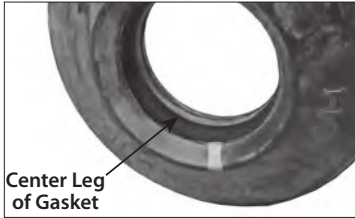

**2. JOIN MATING COMPONENTS:** Align the centerlines of the two grooved mating component ends. Insert the smaller mating component end into the smaller opening of the gasket and the larger mating component end into the larger opening of the gasket until contact with the center leg occurs. **NOTE:** Verify that no portion of the gasket extends into the groove of either mating component.

### CAUTION

- Verify that the gasket does not become rolled or pinched while installing the housings.

Failure to follow this instruction could cause gasket damage, resulting in joint leakage.

### NOTICE

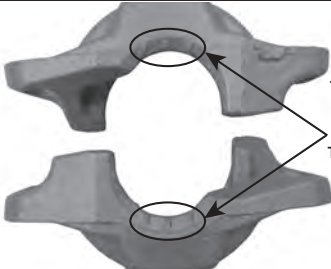

1-inch/DN25 IGS Side of Housings Contains Three Raised Features, as Shown

- Match the correct size opening of each housing before attempting to install the housings (refer to the size markings on top of each housing). In addition, the 1-inch/DN25 IGS side of the housings contains three raised features.



**3. INSTALL HOUSINGS:** Install the housings over the gasket. Verify that the housings' keys engage the grooves completely on both mating components and that each side of the housing is facing the corresponding mating component side.



**4. INSTALL BOLTS/NUTS:** Install the bolts and thread a nut finger-tight onto each bolt. **NOTE:** Verify that the oval neck of each bolt seats properly in the bolt hole.

**5. TIGHTEN NUTS:** Follow steps 5 – 6 on pages 106 – 108 to complete the assembly.

# INSTRUCTIONS FOR REASSEMBLY OF STYLE 171 COUPLINGS

## ! WARNING



- Always verify that the piping system has been completely depressurized and drained immediately prior to installation, removal, adjustment, or maintenance of any Victaulic products.

- Confirm that any equipment, branch lines, or sections of piping that may have been isolated for/during testing or due to valve closures/positioning are identified, depressurized, and drained immediately prior to installation, removal, adjustment, or maintenance of any Victaulic products.

Failure to follow this instruction could result in death or serious personal injury and property damage.

1. Verify that the system is depressurized and drained completely before attempting to disassemble any couplings.
2. Loosen the nuts of the coupling assembly to permit removal of the coupling from the mating component ends.
3. Remove the nuts, bolts, and gasket from the housings. Inspect all components for any damage or wear. If any damage or wear is present, use a new Victaulic-supplied coupling assembly.
4. Check mating component ends, as described in step 2 on page 85.

## ! CAUTION

- A thin coat of a compatible lubricant shall be used to help prevent the gasket from pinching, rolling, or tearing during reassembly.
- DO NOT use excessive lubricant on the gasket sealing lips and exterior.

Failure to use a compatible lubricant may cause gasket damage, resulting in joint leakage and property damage.



5. **FOR REASSEMBLY, LUBRICATE GASKET:** Apply a thin coat of a compatible lubricant to the gasket sealing lips and exterior. Refer to the “Lubricant Compatibility for Gaskets” table on page 34.



6. **INSTALL GASKET:** Install the gasket over the mating component end. **NOTE:** Verify that the gasket does not overhang the mating component end.



**7. JOIN MATING COMPONENTS:** Align the centerlines of the two grooved mating component ends. Slide the gasket into position and center it between the groove of each mating component. **NOTE:** Verify that no portion of the gasket extends into the groove of either mating component.

**! CAUTION**

- Verify that the gasket does not become rolled or pinched while installing the housings.

Failure to follow this instruction could cause gasket damage, resulting in joint leakage.



**8. INSTALL HOUSINGS:** Install the housings over the gasket. Verify that the housings' keys engage the grooves completely on both mating components.



**9. INSTALL BOLTS/NUTS:** Install the bolts, and thread a nut finger-tight onto each bolt. **NOTE:** Verify that the oval neck of each bolt seats properly in the bolt hole.

**10. TIGHTEN NUTS:** Follow steps 7 – 8 on page 111 to complete the assembly.

# INSTRUCTIONS FOR REASSEMBLY OF STYLE 004N, 177N, AND 877N COUPLINGS

## WARNING



- Always verify that the piping system has been completely depressurized and drained immediately prior to installation, removal, adjustment, or maintenance of any Victaulic products.

- Confirm that any equipment, branch lines, or sections of piping that may have been isolated for/during testing or due to valve closures/positioning are identified, depressurized, and drained immediately prior to installation, removal, adjustment, or maintenance of any Victaulic products.
- Failure to follow this instruction could result in death or serious personal injury and property damage.

## NOTICE



Two methods can be followed for reassembly of  
Style 004N, 177N, and 877N Couplings.

- **METHOD 1 FOR REASSEMBLY:** The coupling can be reassembled into its “installation-ready” condition by installing the gasket into the housings, then inserting the bolts and threading a nut onto each bolt until 2 – 3 threads are exposed, as shown to the left. If this method is chosen, steps 1 – 5 on this page, along with the tightening sequence steps described in the applicable coupling installation instructions on the previous pages, shall be followed.
- OR
- **METHOD 2 FOR REASSEMBLY:** The gasket and housings can be assembled onto the mating component ends by following steps 1 – 5 on this page, along with all steps in the “Method 2 for Reassembly” section on the following page.

Follow these five steps for Method 1 or Method 2:

1. Verify that the system is depressurized and drained completely before attempting to disassemble any couplings.
2. Loosen the nuts of the coupling assembly to permit removal of the coupling from the mating component ends.
3. Remove the nuts, bolts, and gasket from the housings. Inspect all components for any damage or wear. If any damage or wear is present, use a new Victaulic-supplied coupling assembly.
4. Check mating component ends, as described in the applicable coupling installation instructions on the previous pages.

## CAUTION

- A thin coat of a compatible lubricant shall be used to help prevent the gasket from pinching, rolling, or tearing during reassembly.
  - **DO NOT** use excessive lubricant on the gasket sealing lips and exterior.
- Failure to use a compatible lubricant may cause gasket damage, resulting in joint leakage and property damage.



5. **FOR REASSEMBLY, LUBRICATE GASKET:** Apply a thin coat of a compatible lubricant to the gasket sealing lips and exterior. Refer to the “Lubricant Compatibility for Gaskets” table on page 34.

## Method 2 for Reassembly

### NOTICE

- The photos in this section show reassembly of a Style 177N Coupling; however, the same steps apply to reassembly of a Style 004N and 877N Coupling.

1. Verify that steps 1 – 5 on the previous page have been followed.

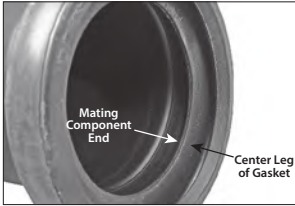

**2. INSTALL GASKET:** Insert the grooved end of a mating component into the gasket until it contacts the center leg of the gasket.



**3. JOIN MATING COMPONENTS:** Align the centerlines of the two grooved mating component ends. Insert the other mating component end into the gasket until it contacts the center leg of the gasket. **NOTE:** Verify that no portion of the gasket extends into the groove of either mating component.

### ! CAUTION

- Verify that the gasket does not become rolled or pinched while installing the housings.

Failure to follow this instruction could cause gasket damage, resulting in joint leakage.



**4. INSTALL HOUSINGS:** Install the housings over the gasket. Verify that the housings' keys engage the grooves completely on both mating components.

**5. INSTALL BOLTS/NUTS:** Install the bolts, and thread a nut finger-tight onto each bolt. **NOTE:** Verify that the oval neck of each bolt seats properly in the bolt hole.

**6. TIGHTEN NUTS:** To complete the assembly, follow the tightening sequence described in the applicable coupling installation instructions on the previous pages.

*This page intentionally left blank*



I-100\_124

INSTALLATION-READY™ COUPLINGS FOR  
GROOVED-END MATING COMPONENTS  
INSTALLATION INSTRUCTIONS REV\_H

# **FireLock™ Installation-Ready™ Fittings for Grooved-End Mating Components**

**Installation Instructions**

**Instructions for Reassembly**

# PREPARATORY STEPS FOR INSTALLATION OF FITTINGS FEATURED IN THIS SECTION

## ! WARNING



- Read and understand all instructions before attempting to install any Victaulic products.
- Always verify that the piping system has been completely depressurized and drained immediately prior to installation, removal, adjustment, or maintenance of any Victaulic products.
- Confirm that any equipment, branch lines, or sections of piping that may have been isolated for/during testing or due to valve closures/positioning are identified, depressurized, and drained immediately prior to installation, removal, adjustment, or maintenance of any Victaulic products.
- These installation instructions are intended for an experienced, trained installer. The installer shall understand the use of this product and why it was specified for the particular application.
- The installer shall understand common industry safety standards and potential consequences of improper product installation.
- Wear safety glasses, hardhat, and foot protection.

Failure to follow these instructions could result in death or serious personal injury and property damage.

## ! WARNING

IGS<sup>®</sup> Groove Profile for 1-inch/DN25  
FireLock<sup>™</sup> Installation-Ready<sup>™</sup> Fittings



Original Groove System (OGS) Groove Profile  
for Sizes Greater Than 1-inch/DN25



- FireLock<sup>™</sup> Installation-Ready<sup>™</sup> Fittings in the 1-inch/DN25 size shall be used **ONLY** with mating components that are prepared to Victaulic IGS proprietary groove specifications.
- FireLock<sup>™</sup> Installation-Ready<sup>™</sup> Fittings in sizes greater than 1-inch/DN25 shall be used **ONLY** with mating components that are prepared to Victaulic OGS groove specifications.
- **DO NOT** attempt to install these products on mating components that are prepared to any groove specification other than what is specified in their respective installation instructions.

Failure to follow these instructions could cause joint failure, resulting in death or serious personal injury and property damage.

## Instructions for the Initial Installation of No. 101, 102, 103, and 104 Fittings



No. 101 Fitting Shown Above

- 1. DO NOT DISASSEMBLE THE FITTING FOR INITIAL INSTALLATION:** Victaulic<sup>®</sup> FireLock<sup>™</sup> Installation-Ready<sup>™</sup> Fittings are designed so that the installer does not need to remove the nuts and bolts for initial installation. This facilitates installation by allowing the installer to directly insert the grooved end of mating components into the fitting.

**2. CHECK MATING COMPONENT ENDS:** The outside surface of the mating components, between the groove and the mating component ends, shall be generally free from indentations, projections, weld seam anomalies, and roll marks to ensure a leak-tight seal. All oil, grease, loose paint, dirt, and cutting particles shall be removed. Always verify that the correct groove profile is being used.

**For FireLock™ Installation-Ready™ Fittings in the 1-inch/DN25 size:** The mating components' outside diameter ("OD"), groove dimensions, and maximum allowable flare diameter shall be within the tolerances listed in this handbook for Victaulic IGS groove specifications.

**For FireLock™ Installation-Ready™ Fittings in sizes greater than 1-inch/DN25:** The mating components' outside diameter ("OD"), groove dimensions, and maximum allowable flare diameter shall be within the tolerances listed in this handbook for Victaulic OGS groove specifications.

## NOTICE

- For Victaulic® FireLock™ products that are provided with pre-lubricated gaskets, refer to the "NOTICE" and the "Dry Pipe Fire Protection Systems Notes" section on page 36 for additional information.

**3a. CHECK GASKET:** Check the gasket to verify that it is suitable for the intended service. The color code identifies the material grade. Refer to page 32 for the "Gasket Color Code Reference" table and the "NOTICE" on page 36 for important gasket information. For complete compatibility information, reference Victaulic publications 05.01 and GSG-100, which can be downloaded at [victaulic.com](http://victaulic.com).



## CAUTION

- If any conditions listed in the "NOTICE" on page 36 are met, a thin coat of a compatible lubricant shall be applied only to the gasket sealing lips to help prevent the gasket from pinching, rolling, or tearing during installation.
- DO NOT use excessive lubricant on the gasket sealing lips.

Failure to use a compatible lubricant may cause gasket damage, resulting in joint leakage and property damage.

**3b.** If any conditions listed in the "NOTICE" on page 36 are met, apply a thin coat of a compatible lubricant only to the gasket sealing lips. Refer to the "Lubricant Compatibility for Gaskets" table on page 34.

**Important Information for Use of No. 101, 102, 103, and 104 Fittings with End Caps:**



## WARNING

- Always read and follow the "Victaulic End Cap Installation Safety Instructions" section in this handbook.

Failure to the "Victaulic End Cap Installation Safety Instructions" section could result in death or serious personal injury and property damage.

- When assembling No. 101, 102, 103, or 104 Fittings onto end caps, take additional time to inspect and verify that the end cap is seated fully against the pipe stop of the gasket.
- For the 1-inch/DN25 size, use only No. 146 FireLock™ IGS™ End Caps containing the "PG" marking. No. 006 and No. 60 Ends Caps in the 1-inch/DN25 size SHALL NOT be used.
- For 1 ¼-inch/DN32 and larger sizes, use only Victaulic FireLock™ No. 006 End Caps containing the "EZ" marking on the inside face or Victaulic End Caps containing the "QV" or "EZ QV" marking on the inside face.
- Always confirm that any equipment, branch lines, or sections of piping that may have been isolated for/during testing or due to valve closures/positioning are identified, depressurized, and drained immediately prior to working with an end cap.

## No. 101 (90° Elbow) and No. 103 (45° Elbow) - FireLock™

Installation-Ready™ Fittings

### **WARNING**



- Read and understand all instructions before attempting to install any Victaulic products.
- Always verify that the piping system has been completely depressurized and drained immediately prior to installation, removal, adjustment, or maintenance of any Victaulic products.
- Confirm that any equipment, branch lines, or sections of piping that may have been isolated for/during testing or due to valve closures/positioning are identified, depressurized, and drained immediately prior to installation, removal, adjustment, or maintenance of any Victaulic products.
- Wear safety glasses, hardhat, and foot protection.
- No. 101 and 103 Victaulic® FireLock™ Installation-Ready™ Fittings shall be used only in fire protection systems that are designed and installed in accordance with current, applicable National Fire Protection Association (NFPA 13, 13D, 13R, etc.) standards, or equivalent standards, and in accordance with applicable building and fire codes. These standards and codes contain important information regarding protection of systems from freezing temperatures, corrosion, mechanical damage, etc.
- These installation instructions are intended for an experienced, trained installer. The installer shall understand the use of this product and why it was specified for the particular application.
- The installer shall understand common industry safety standards and potential consequences of improper product installation.

Failure to follow installation requirements and local and national codes and standards could compromise system integrity or cause system failure, resulting in death or serious personal injury and property damage.

### NO. 101/103 INSTALLATION METHOD 1

1. Follow all instructions in the “Preparatory Steps” section on pages 126 – 127.

### **NOTICE**

- The images in this section show installation of a No. 101 Fitting; however, the same steps apply to installation of a No. 103 Fitting.

### **WARNING**



- Never leave a No. 101 or 103 Fitting partially assembled on mating component ends. **ALWAYS TIGHTEN THE HARDWARE IMMEDIATELY, IN ACCORDANCE WITH THESE INSTRUCTIONS.** A partially assembled fitting poses a drop or fall hazard during installation and a burst hazard during testing.



- Keep hands away from the mating component ends and the openings of the fitting when attempting to insert grooved mating component ends into the fitting.
- Keep hands away from fitting openings during tightening. Failure to follow these instructions could result in death or serious personal injury and property damage.





### 2a. INSERT FIRST MATING COMPONENT

**END:** Assemble the joint by inserting a grooved mating component end into one opening of the fitting. The grooved mating component end shall be inserted into the fitting until contact with the pipe stop of the gasket occurs. A visual check is required to verify that the fitting's keys align with the groove in the mating component end.

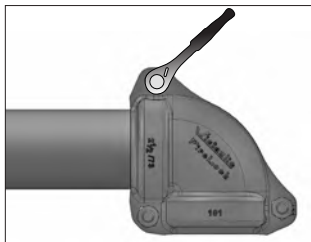

### 2b. TIGHTEN NUT AT FIRST OUTSIDE LOCATION

**LOCATION:** Using an impact tool or standard socket wrench with a deep-well socket, tighten the nut at the first outside location until the fitting is secured safely to the pipe, but do not tighten past initial metal-to-metal bolt pad contact. Verify that the fitting's keys engage the groove completely and that the oval neck of the bolt seats properly in the bolt hole.

Refer to the "Impact Tool Usage Guidelines" and "Impact Tool Selection" sections in this handbook, along with the "Helpful Information" table on the following page.



OVAL NECK OF BOLT SEATED PROPERLY



OVAL NECK OF BOLT NOT SEATED PROPERLY

## NOTICE

- Never force installation. Mating components should insert easily into the fitting.
- If experiencing difficulty inserting mating components, verify that the gasket is lubricated and seated properly within the housings, that the mating component dimensions and grooves are within Victaulic specifications, and that the hardware is loose enough to accommodate mating component insertion.

## ! WARNING

- At this point, the fitting is only partially installed.
- The fitting shall be treated as a potential drop hazard and shall not be left unattended.

Failure to follow these instructions could result in death or serious personal injury and property damage.



### 3a. INSERT SECOND MATING COMPONENT

**END:** Insert the second grooved mating component end into the second opening of the fitting. The grooved mating component end shall be inserted into the fitting until contact with the pipe stop of the gasket occurs. A visual check is required to verify that the fitting's keys align with the groove in the mating component end.

**NOTE:** If the mating component cannot be inserted into the fitting, incrementally loosen the nut that was tightened in step 4b just until the mating component is inserted (refer to the warning above).



**3b. COMPLETELY TIGHTEN NUT AT INSIDE LOCATION:** Completely tighten the nut at the inside location until metal-to-metal contact occurs at the bolt pads. Verify that the fitting's keys still engage the grooves completely and that the oval neck of the bolt seats properly in the bolt hole.



**4. COMPLETELY TIGHTEN NUT AT SECOND OUTSIDE LOCATION:** Completely tighten the nut at the second outside location until metal-to-metal contact occurs at the bolt pads. Verify that the fitting's keys still engage the grooves completely and that the oval neck of the bolt seats properly in the bolt hole.

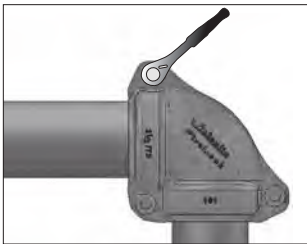

**5. COMPLETELY TIGHTEN NUT AT FIRST OUTSIDE LOCATION:** Go back and completely tighten the nut at the first outside location to confirm metal-to-metal contact at the bolt pads.

DO NOT continue to tighten the nuts after the visual, metal-to-metal bolt pad inspection requirement is achieved. **If you suspect that any hardware has been over-tightened (as indicated by a bend in the bolt, bulging of the nut at the bolt pad interface, or damage to the bolt pad, etc.), the entire fitting assembly shall be replaced immediately.** Refer to the "Impact Tool Usage Guidelines" and "Impact Tool Selection" sections in this handbook, along with the "Helpful Information" table below.

### Helpful Information

Nominal Pipe Size inches/DN	Actual Pipe Outside Diameter inches/mm	Nut Size inches/ Metric	Deep-Well Socket Size inches/mm	Maximum Allowable Bolt Torque*
1 DN25	1.315 33.7	3/8 M10	1 1/16 17	55 ft-lbs 75 N•m
1 1/4 DN32	1.660 42.1	3/8 M10	1 1/16 17	55 ft-lbs 75 N•m
1 1/2 DN40	1.900 48.3	3/8 M10	1 1/16 17	55 ft-lbs 75 N•m
2 DN50	2.375 60.3	7/16 M11	1 1/16 17	100 ft-lbs 136 N•m
2 1/2	2.875 73.0	7/16 M11	1 1/16 17	100 ft-lbs 136 N•m
DN65	3.000 76.1	7/16 M11	1 1/16 17	100 ft-lbs 136 N•m

\*Maximum allowable bolt torque values have been derived from actual test data



## ! WARNING

Nuts shall be tightened in the sequence shown on pages 129 – 130 until metal-to-metal contact occurs at the bolt pads.

Failure to tighten nuts in the sequence shown will cause increased loading of the hardware, resulting in the following conditions:

- Excessive bolt torque required to assemble the joint (incomplete assembly)
- Damage to the assembled joint (damaged or broken bolt pads or fractures to housings)
- Bolt damage or fracture
- Joint leakage and property damage
- A negative impact on system integrity
- Personal injury or death

**DO NOT** continue to tighten the nuts after the visual, metal-to-metal bolt pad inspection requirement is achieved.

- Failure to follow this instruction could result in the conditions listed above.

## NOTICE

- An impact tool or standard socket wrench with a deep-well socket can be used to bring the bolt pads into metal-to-metal contact.
- Refer to the “Impact Tool Usage Guidelines” and “Impact Tool Selection” sections, along with the “Helpful Information” table on the previous page.

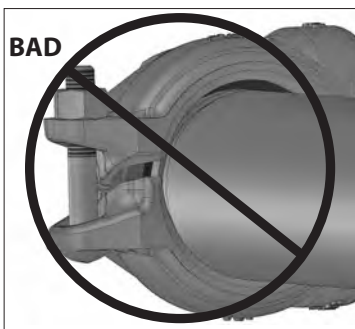
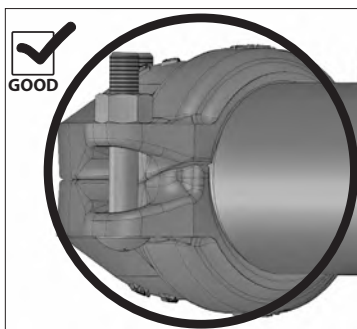

**6. REQUIRED INSPECTION TECHNIQUE – VISUAL INSPECTION:** VERIFY THAT ALL NUTS ARE TIGHTENED APPROPRIATELY AND THAT METAL-TO-METAL CONTACT IS ACHIEVED AT ALL BOLT PADS. Visually inspect all bolt pads at each joint to verify metal-to-metal contact with positive or neutral offsets at the angled bolt pads and metal-to-metal contact at the flat bolt pads. If the bolt pads do not reach metal-to-metal contact, loosen the nuts at the angled bolt pads, then retighten all nuts evenly by alternating bolt pad locations. If the bolt pads still do not reach metal-to-metal contact, remove the fitting from the mating component ends and verify that the mating components' outside diameter (“OD”), groove dimensions, and maximum allowable flare diameter are within the specifications listed in this handbook for the applicable groove profile.

**NOTE:** Before pressurizing the system, the fitting may be adjusted by loosening the appropriate hardware. After repositioning the fitting, the hardware shall be retightened until the installation requirements listed in these instructions are achieved.

## ! WARNING

- Visual inspection of each joint is required.
- Improperly assembled joints shall be corrected before the system is filled, tested, or placed into service.
- Any components that exhibit physical damage due to improper assembly shall be replaced before the system is filled, tested, or placed into service.

Failure to follow these instructions could cause joint failure, resulting in death or serious personal injury and property damage.

### 6a. INSPECTION TECHNIQUE – TORQUE WRENCH METHOD:

If additional fitting assembly inspection is determined to be necessary by others, a torque wrench method may be used.

**NOTE:** Satisfying step 6 is first required before proceeding with the torque wrench method. The suggested bolt torque range for an assembled fitting that satisfies the visual inspection requirements of step 6 shall be as follows:

Bolt Size inches/Metric	Minimum Assembled Bolt Torque*	Maximum Assembled Bolt Torque
3/8 M10	20 ft-lbs 27 N•m	55 ft-lbs 75 N•m
7/16 M11	25 ft-lbs 34 N•m	80 ft-lbs 108 N•m

\* LPCB compliant assemblies shall meet the Minimum Assembled Bolt Torque, as noted in the table above.

## NO. 101/103 INSTALLATION METHOD 2

1. Follow all instructions in the “Preparatory Steps” section on pages 126 – 127.

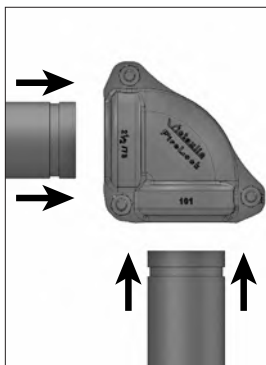

2. When practical, both grooved mating component ends may be inserted into the fitting prior to tightening. Verify that the mating component ends are inserted into the fitting until contact with the pipe stop of the gasket occurs. A visual check is required to verify that the fitting's keys align with the grooves in the mating component ends. The hardware shall be tightened evenly by alternating bolt pad locations until the installation requirements listed in these instructions are achieved.

3. Before pressurizing the system, the fitting may be adjusted by loosening the appropriate hardware. After repositioning the fitting, the hardware shall be retightened until the installation requirements listed in these instructions are achieved.

## REMOVAL OF A NO. 101 OR 103 FITTING FROM THE PIPING SYSTEM

### WARNING



- Always verify that the piping system has been completely depressurized and drained immediately prior to installation, removal, adjustment, or maintenance of any Victaulic products.

- Confirm that any equipment, branch lines, or sections of piping that may have been isolated for/during testing or due to valve closures/positioning are identified, depressurized, and drained immediately prior to installation, removal, adjustment, or maintenance of any Victaulic products.
- Never leave a No. 101 or 103 Fitting partially assembled on mating component ends. A partially assembled fitting poses a drop or fall hazard.

Failure to follow these instructions could result in death or serious personal injury and property damage.

### NOTICE

- No. 101 and No. 103 Fittings DO NOT need to be fully disassembled for removal.
- The images in this section show removal of a No. 101 Fitting; however, the same steps apply to installation of a No. 103 Fitting.

1. Verify that the system is depressurized and drained completely before attempting to remove any fittings from the piping system.

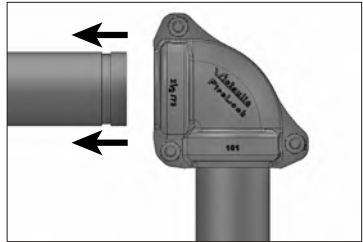
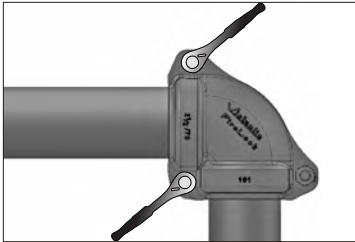

2. Loosen the nuts only on the outside and inside locations of the fitting end where the first mating component is to be removed (nuts should be threaded no further than flush with the end of the bolts). Remove the mating component from the loosened side. Verify that the fitting is secured to the other mating component to prevent the fitting from falling.

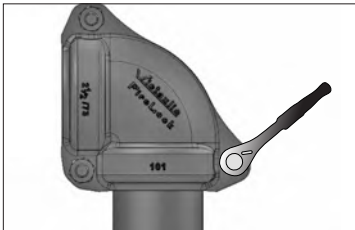

3. While supporting the fitting, loosen the nut at the second outside location. Carefully remove the fitting from the mating component.
4. Inspect all components for any damage or wear, including tears in gasket lips, deformities in gasket lips, or pinched sections at the bolt pad locations. If any damage or wear is present, use a new Victaulic-supplied fitting assembly.
- 5a. After inspection of the fitting, if it is determined that the fitting can be reused in its current condition, follow all steps of the applicable installation method section.
- 5b. If the fitting is fully disassembled for any reason, refer to the reassembly instructions on the following page.

## REASSEMBLY OF A NO. 101 OR 103 FITTING THAT WAS FULLY DISASSEMBLED DURING REMOVAL FROM THE PIPING SYSTEM

### NOTICE

- No. 101 and 103 Fittings **DO NOT** need to be fully disassembled for removal. However, if a fitting is fully disassembled during maintenance or for any other reason, the following steps shall be completed.
- The fitting shall be reassembled, as shown in the steps below, before attempting to reinstall the product.

1. Inspect all components for any damage or wear. If any damage or wear is present, use a new Victaulic-supplied fitting assembly.
2. Check mating component ends, as described in step 2 on page 127.

### ! CAUTION

- A thin coat of a compatible lubricant shall be used to help prevent the gasket from pinching, rolling, or tearing during reassembly.
  - **DO NOT** use excessive lubricant on the gasket sealing lips and exterior.
- Failure to use a compatible lubricant may cause gasket damage, resulting in joint leakage and property damage.

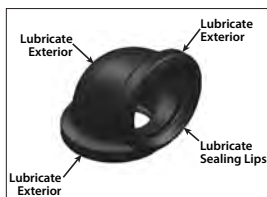

**3a. VERIFY THAT THE CORRECT-SIZE GASKET IS BEING USED FOR REASSEMBLY.**

**3b. FOR REASSEMBLY OF NO. 101 AND 103 FITTINGS, LUBRICATE GASKET:** Apply a thin coat of a compatible lubricant to the gasket sealing lips and exterior, as shown to the left. Refer to the “Lubricant Compatibility for Gaskets” table on page 34.



**4. INSTALL GASKET INTO FIRST FITTING HOUSING:** Install the gasket into one of the housings. Verify that the ends of the gasket are seated in the housing's pockets, as shown to the left.



**5. INSTALL SECOND FITTING HOUSING:** Install the second fitting housing. Verify that the ends of the gasket are seated in the housings' pockets.



**6. INSTALL BOLTS AND NUTS:** Install the bolts, and thread a nut onto each bolt. **NOTE:** Verify that the oval neck of each bolt seats properly in the bolt hole. **DO NOT** tighten the nuts completely. The bolt pads need to be set at a gap for reinstallation of the fitting. Two to three full bolt threads, exposed above each nut, will provide the proper gap.

7. Follow all steps of the applicable installation method section to complete the assembly.

### ! WARNING



- Read and understand all instructions before attempting to install any Victaulic products.
- Always verify that the piping system has been completely depressurized and drained immediately prior to installation, removal, adjustment, or maintenance of any Victaulic products.
- Confirm that any equipment, branch lines, or sections of piping that may have been isolated for/during testing or due to valve closures/positioning are identified, depressurized, and drained immediately prior to installation, removal, adjustment, or maintenance of any Victaulic products.
- Wear safety glasses, hardhat, and foot protection.
- No. 102 and 104 Victaulic® FireLock™ Installation-Ready™ Fittings shall be used only in fire protection systems that are designed and installed in accordance with current, applicable National Fire Protection Association (NFPA 13, 13D, 13R, etc.) standards, or equivalent standards, and in accordance with applicable building and fire codes. These standards and codes contain important information regarding protection of systems from freezing temperatures, corrosion, mechanical damage, etc.
- These installation instructions are intended for an experienced, trained installer. The installer shall understand the use of this product and why it was specified for the particular application.
- The installer shall understand common industry safety standards and potential consequences of improper product installation.

Failure to follow installation requirements and local and national codes and standards could compromise system integrity or cause system failure, resulting in death or serious personal injury and property damage.

## NO. 102/104 INSTALLATION METHOD 1 – MATING COMPONENTS INSERTED INTO RUN ENDS FIRST

1. Follow all instructions in the “Preparatory Steps” section on pages 126 – 127.

### NOTICE

- The images in this section show installation of a No. 102 Fitting; however, the same steps apply to installation of a No. 104 Fitting.

### ! WARNING



- Never leave a No. 102 or 104 Fitting partially assembled on mating component ends. **ALWAYS TIGHTEN THE HARDWARE IMMEDIATELY, IN ACCORDANCE WITH THESE INSTRUCTIONS.** A partially assembled fitting poses a drop or fall hazard during installation and a burst hazard during testing.
- Keep hands away from the mating component ends and the openings of the fitting when attempting to insert grooved mating component ends into the fitting.
- Keep hands away from fitting openings during tightening. Failure to follow these instructions could result in death or serious personal injury and property damage.

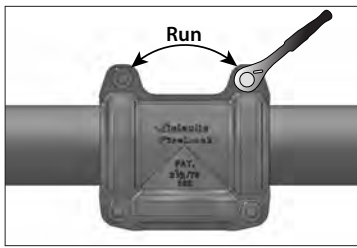
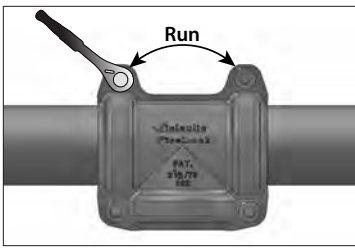

OVAL NECK OF BOLT SEATED PROPERLY



OVAL NECK OF BOLT NOT SEATED PROPERLY

**2a. INSERT MATING COMPONENTS INTO RUN ENDS:** Insert a grooved mating component into each run end of the fitting. The grooved mating component ends shall be inserted into the fitting until contact with each pipe stop of the gasket occurs. A visual check is required to verify that the fitting's keys align with the groove in each mating component.

**2b. TIGHTEN NUTS ALONG THE RUN ENDS:** Using an impact tool or standard socket wrench with a deep-well socket, tighten the nuts along the run ends until the fitting is secured safely to the mating components, but do not tighten past initial metal-to-metal bolt pad contact. Verify that the fitting's keys engage the grooves completely and that the oval neck of each bolt seats properly in the bolt hole. Refer to the "Impact Tool Usage Guidelines" and "Impact Tool Selection" sections in this handbook, along with the applicable "Helpful Information" table on the following page.

## NOTICE

- **DO NOT** insert only one grooved mating component into the run end of the fitting and then tighten the hardware. Doing so will prevent insertion of a grooved mating component into the second run end of the fitting.
- **Never** force installation. Mating components should insert easily into the fitting.
- If experiencing difficulty inserting mating components, verify that the gasket is lubricated and seated properly within the housings, that the mating component dimensions and grooves are within Victaulic specifications, and that the hardware is loose enough to accommodate mating component insertion.

## ! WARNING

- At this point, the fitting is only partially installed.
- The fitting shall be treated as a potential drop hazard and shall not be left unattended.

Failure to follow these instructions could result in death or serious personal injury and property damage.



OVAL NECK OF BOLT SEATED PROPERLY



OVAL NECK OF BOLT NOT SEATED PROPERLY

**3a. INSERT MATING COMPONENT INTO THE BRANCH END:** Insert the third grooved mating component into the opening of the branch end. The grooved mating component end shall be inserted into the fitting until contact with the pipe stop of the gasket occurs. A visual check is required to verify that the fitting's keys align with the groove in the mating component.

**3b. TIGHTEN NUTS ALONG THE BRANCH END:** Tighten the nuts along the branch end until metal-to-metal contact occurs at the bolt pads. Verify that the fitting's keys engage the groove completely and that the oval neck of each bolt seats properly in the bolt hole.

#### No. 102 Helpful Information

Nominal Pipe Size inches/DN	Actual Pipe Outside Diameter inches/mm	Nut Size inches/Metric	Deep-Well Socket Size inches/mm	Maximum Allowable Bolt Torque*
1 DN25	1.315 33.7	$\frac{3}{8}$ M10	$\frac{1}{16}$ 17	55 ft-lbs 75 N•m
1 $\frac{1}{4}$ DN32	1.660 42.1	$\frac{3}{8}$ M10	$\frac{1}{16}$ 17	55 ft-lbs 75 N•m
1 $\frac{1}{2}$ DN40	1.900 48.3	$\frac{3}{8}$ M10	$\frac{1}{16}$ 17	55 ft-lbs 75 N•m
2 DN50	2.375 60.3	$\frac{7}{16}$ M11	$\frac{1}{16}$ 17	100 ft-lbs 136 N•m
2 $\frac{1}{2}$	2.875 73.0	$\frac{7}{16}$ M11	$\frac{1}{16}$ 17	100 ft-lbs 136 N•m
DN65	3.000 76.1	$\frac{7}{16}$ M11	$\frac{1}{16}$ 17	100 ft-lbs 136 N•m

\*Maximum allowable bolt torque values have been derived from actual test data

#### No. 104 Helpful Information

	Nut Size inches/Metric	Deep-Well Socket Size inches/mm	Maximum Allowable Bolt Torque*
All Sizes	$\frac{7}{16}$ M11	$\frac{1}{16}$ 17	100 ft-lbs 136 N•m

\*Maximum allowable bolt torque values have been derived from actual test data

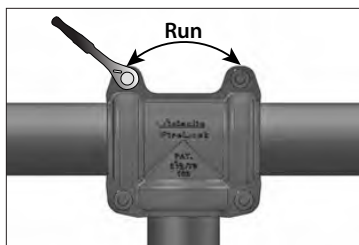

**4. COMPLETELY TIGHTEN NUTS ALONG THE RUN ENDS:** Tighten the nuts along the run ends until metal-to-metal contact occurs at the bolt pads. DO NOT continue to tighten the nuts after the visual, metal-to-metal bolt pad inspection requirement is achieved. **If you suspect that any hardware has been over-tightened (as indicated by a bend in the bolt, bulging of the nut at the bolt pad interface, or damage to the bolt pad, etc.), the entire fitting assembly shall be replaced immediately.** Refer to the “Impact Tool Usage Guidelines” and “Impact Tool Selection” sections in this handbook, along with the applicable “Helpful Information” table on the previous page.

## **! WARNING**

Nuts shall be tightened in the sequence shown on pages 136 – 138 until metal-to-metal contact occurs at the bolt pads.

Failure to tighten nuts in the sequence shown will cause increased loading of the hardware, resulting in the following conditions:

- Excessive bolt torque required to assemble the joint (incomplete assembly)
- Damage to the assembled joint (damaged or broken bolt pads or fractures to housings)
- Bolt damage or fracture
- Joint leakage and property damage
- A negative impact on system integrity
- Personal injury or death

DO NOT continue to tighten the nuts after the visual, metal-to-metal bolt pad inspection requirement is achieved.

- Failure to follow this instruction could result in the conditions listed above.

## **NOTICE**

- An impact tool or standard socket wrench with a deep-well socket can be used to bring the bolt pads into metal-to-metal contact.
- Refer to the “Impact Tool Usage Guidelines” and “Impact Tool Selection” sections, along with the applicable “Helpful Information” table on the previous page.

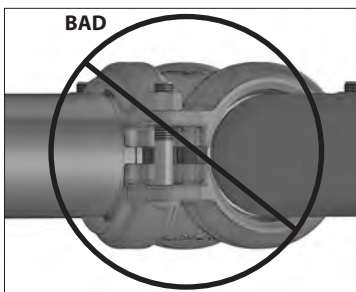
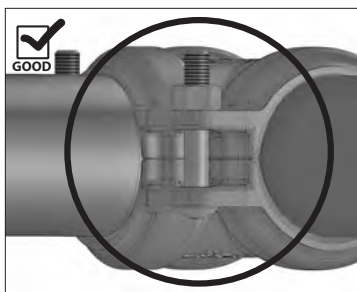

**5. REQUIRED INSPECTION TECHNIQUE – VISUAL INSPECTION:** VERIFY THAT ALL NUTS ARE TIGHTENED APPROPRIATELY AND THAT METAL-TO-METAL CONTACT IS ACHIEVED AT ALL BOLT PADS. Visually inspect all bolt pads at each joint to verify metal-to-metal contact with positive or neutral offsets at the angled bolt pads and metal-to-metal contact at the flat bolt pads. If the bolt pads do not reach metal-to-metal contact, loosen the nuts at the angled bolt pads, then retighten all nuts evenly by alternating bolt pad locations. If the bolt pads still do not reach metal-to-metal contact, remove the fitting from the mating component ends and verify that the mating components' outside diameter ("OD"), groove dimensions, and maximum allowable flare diameter are within the specifications listed in this handbook for the applicable groove profile.

**NOTE:** Before pressurizing the system, the fitting may be adjusted by loosening the appropriate hardware. After repositioning the fitting, the hardware shall be retightened until the installation requirements listed in these instructions are achieved.

### ! WARNING

- Visual inspection of each joint is required.
  - Improperly assembled joints shall be corrected before the system is filled, tested, or placed into service.
  - Any components that exhibit physical damage due to improper assembly shall be replaced before the system is filled, tested, or placed into service.
- Failure to follow these instructions could cause joint failure, resulting in death or serious personal injury and property damage.

#### 5a. INSPECTION TECHNIQUE – TORQUE WRENCH METHOD:

If additional fitting assembly inspection is determined to be necessary by others, a torque wrench method may be used.

**NOTE:** Satisfying step 5 is first required before proceeding with the torque wrench method. The suggested bolt torque range for an assembled fitting that satisfies the visual inspection requirements of step 5 shall be as follows:

Bolt Size inches/Metric	Minimum Assembled Bolt Torque*	Maximum Assembled Bolt Torque
3/8 M10	20 ft-lbs 27 N•m	55 ft-lbs 75 N•m
7/16 M11	25 ft-lbs 34 N•m	80 ft-lbs 108 N•m

\* LPCB compliant assemblies shall meet the Minimum Assembled Bolt Torque, as noted in the table above.

## NO. 102/104 INSTALLATION METHOD 2 – MATING COMPONENT INSERTED INTO BRANCH END FIRST

1. Follow all instructions in the “Preparatory Steps” section on pages 126 – 127.



OVAL NECK OF BOLT SEATED PROPERLY



OVAL NECK OF BOLT NOT SEATED PROPERLY

**2a. INSERT MATING COMPONENT INTO BRANCH END:** Insert a grooved mating component end into the opening of the branch end. The grooved mating component end shall be inserted into the fitting until contact with the pipe stop of the gasket occurs. A visual check is required to verify that the fitting's keys align with the groove in the mating component end.

**2b. TIGHTEN NUTS ALONG THE BRANCH END:** Using an impact tool or standard socket wrench with a deep-well socket, tighten the nuts along the branch end until the fitting is secured safely to the mating component. Verify that the fitting's keys engage the groove completely and that the oval neck of each bolt seats properly in the bolt hole. Refer to the “Impact Tool Usage Guidelines” and “Impact Tool Selection” sections in this handbook, along with the applicable “Helpful Information” table on page 137.

### NOTICE

- Never force installation. Mating components should insert easily into the fitting.
- If experiencing difficulty inserting mating components, verify that the gasket is lubricated and seated properly within the housings, that the mating component dimensions and grooves are within Victaulic specifications, and that the hardware is loose enough to accommodate mating component insertion.

### ! WARNING

- At this point, the fitting is only partially installed.
- The fitting shall be treated as a potential drop hazard and shall not be left unattended.

Failure to follow these instructions could result in death or serious personal injury and property damage.

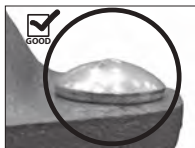
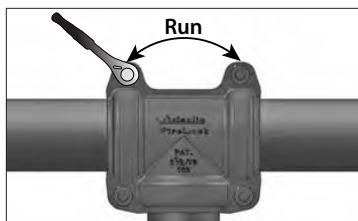

**OVAL NECK OF BOLT SEATED PROPERLY**



**OVAL NECK OF BOLT NOT SEATED PROPERLY**

**3a. INSERT MATING COMPONENTS INTO RUN ENDS:** Insert a grooved mating component end into each run end of the fitting. The grooved mating component ends shall be inserted into the fitting until contact with each pipe stop of the gasket occurs. A visual check is required to verify that the fitting's keys align with the groove in each mating component end. **NOTE:** If the mating component ends cannot be inserted into the fitting, incrementally loosen the nuts that were tightened in step 2b just until all mating component ends can be inserted (refer to the warning above).

**3b. TIGHTEN NUTS ALONG THE RUN SIDE:** Tighten the nuts along the run ends until metal-to-metal contact occurs at the bolt pads. Verify that the fitting's keys engage the grooves completely and that the oval neck of each bolt seats properly in the bolt hole. Refer to the "Impact Tool Usage Guidelines" and "Impact Tool Selection" sections in this handbook, along with the applicable "Helpful Information" table on page 137.

## ! WARNING

Nuts shall be tightened in the sequence shown on pages 140 – 142 until metal-to-metal contact occurs at the bolt pads.

Failure to tighten nuts in the sequence shown will cause increased loading of the hardware, resulting in the following conditions:

- Excessive bolt torque required to assemble the joint (incomplete assembly)
- Damage to the assembled joint (damaged or broken bolt pads or fractures to housings)
- Bolt damage or fracture
- Joint leakage and property damage
- A negative impact on system integrity
- Personal injury or death

**DO NOT** continue to tighten the nuts after the visual, metal-to-metal bolt pad inspection requirement is achieved.

- Failure to follow this instruction could result in the conditions listed above.



**4. COMPLETELY TIGHTEN NUTS ALONG THE BRANCH END:** Tighten the nuts along the branch end until metal-to-metal contact occurs at the bolt pads. DO NOT continue to tighten the nuts after the visual, metal-to-metal bolt pad inspection requirement is achieved. **If you suspect that any hardware has been over-tightened (as indicated by a bend in the bolt, bulging of the nut at the bolt pad interface, or damage to the bolt pad, etc.), the entire coupling assembly shall be replaced immediately.** Refer to the “Impact Tool Usage Guidelines” and “Impact Tool Selection” sections in this handbook, along with the applicable “Helpful Information” table on page 137.

**5. VERIFY THAT ALL NUTS ARE TIGHTENED APPROPRIATELY AND THAT METAL-TO-METAL CONTACT IS ACHIEVED AT ALL BOLT PADS:** Visually inspect all bolt pads at each joint to verify that metal-to-metal contact is achieved, as shown in step 5 on page 139.

**NOTE:** Before pressurizing the system, the fitting may be adjusted by loosening the appropriate hardware. After repositioning the fitting, the hardware shall be retightened until the installation requirements listed in these instructions are achieved.

# NO. 102/104 INSTALLATION METHOD 3 – ALL MATING COMPONENTS INSERTED

1. Follow all instructions in the “Preparatory Steps” section on pages 126 – 127.

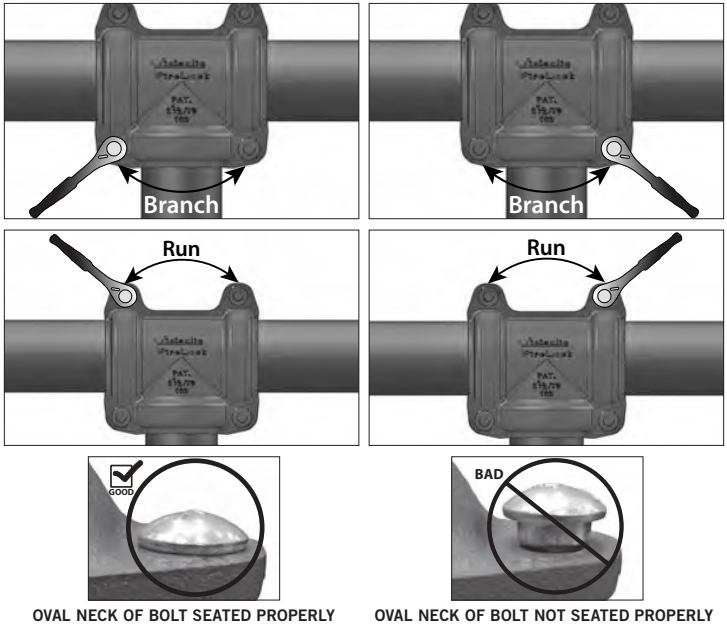

2. When practical, all grooved mating component ends may be inserted into the fitting prior to tightening. The grooved mating component ends shall be inserted into the fitting until contact with each pipe stop of the gasket occurs. A visual check is required to verify that the fitting’s keys align with the groove in each mating component end.

## NOTICE

- **Never force installation.** Mating components should insert easily into the fitting.
- **If experiencing difficulty inserting mating components, verify that the gasket is lubricated and seated properly within the housings, that the mating component dimensions and grooves are within Victaulic specifications, and that the hardware is loose enough to accommodate mating component insertion.**

3. Using an impact tool or standard socket wrench with a deep-well socket, tighten the nuts along the branch end until the fitting is secured safely to the mating component, but do not tighten past initial metal-to-metal bolt pad contact. Verify that the fitting’s keys engage the groove completely and that the oval neck of each bolt seats properly in the bolt hole. Refer to the “Impact Tool Usage Guidelines” and “Impact Tool Selection” sections in this handbook, along with the applicable “Helpful Information” table on page 137.

4. Tighten the nuts along the run ends until metal-to-metal contact occurs at the bolt pads. Verify that the fitting’s keys engage the grooves completely and that the oval neck of each bolt seats properly in the bolt hole. DO NOT continue to tighten the nuts after the visual, metal-to-metal bolt pad inspection requirement is achieved.

*Continued on the following page*

5. Completely tighten the nuts along the branch end until metal-to-metal contact occurs at the bolt pads. DO NOT continue to tighten the nuts after the visual, metal-to-metal bolt pad inspection requirement is achieved. **If you suspect that any hardware has been over-tightened (as indicated by a bend in the bolt, bulging of the nut at the bolt pad interface, or damage to the bolt pad, etc.), the entire fitting assembly shall be replaced immediately.** Refer to the “Impact Tool Usage Guidelines” and “Impact Tool Selection” sections in this handbook, along with the applicable “Helpful Information” table on page 137.

**6. VERIFY THAT ALL NUTS ARE TIGHTENED APPROPRIATELY AND THAT METAL-TO-METAL CONTACT IS ACHIEVED AT ALL BOLT PADS:** Visually inspect all bolt pads at each joint to verify that metal-to-metal contact is achieved, as shown in step 5 on page 139.

**NOTE:** Before pressurizing the system, the fitting may be adjusted by loosening the appropriate hardware. After repositioning the fitting, the hardware shall be retightened until the installation requirements listed in these instructions are achieved.

## REMOVAL OF A NO. 102 OR 104 FITTING FROM THE PIPING SYSTEM

### WARNING



- Always verify that the piping system has been completely depressurized and drained immediately prior to installation, removal, adjustment, or maintenance of any Victaulic products.

- Confirm that any equipment, branch lines, or sections of piping that may have been isolated for/during testing or due to valve closures/positioning are identified, depressurized, and drained immediately prior to installation, removal, adjustment, or maintenance of any Victaulic products.
- Never leave a No. 102 or 104 Fitting partially assembled on mating component ends. A partially assembled fitting poses a drop or fall hazard.

Failure to follow this instruction could result in death or serious personal injury and property damage.

### NOTICE

- No. 102 and No. 104 Fittings DO NOT need to be fully disassembled for removal.
- The images in this section show installation of a No. 102 Fitting; however, the same steps apply to installation of a No. 104 Fitting.

1. Verify that the system is depressurized and drained completely before attempting to remove any fittings from the piping system.

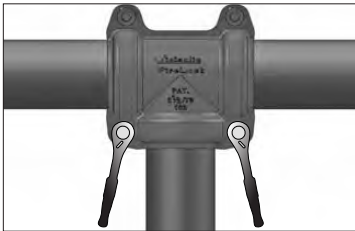

2. Loosen the nuts only along the branch side of the fitting (nuts should be threaded no further than flush with the end of the bolts). Remove the mating component from the loosened branch side. Verify that the fitting is secured to the mating components on the run ends to prevent the fitting from falling.



3. While supporting the fitting, loosen the nuts along the run ends of the fitting. Carefully remove the fitting from the mating components.

4. Inspect all components for any damage or wear, including tears in gasket lips, deformities in gasket lips, or pinched sections at the bolt pad locations. If any damage or wear is present, use a new Victaulic-supplied fitting assembly.

**5a.** After inspection of the fitting, if it is determined that the fitting can be reused in its current condition, follow all steps of the applicable installation method section.

**5b.** If the fitting is fully disassembled for any reason, refer to the reassembly instructions on the following page.

## REASSEMBLY OF A NO. 102 OR 104 FITTING THAT WAS FULLY DISASSEMBLED DURING REMOVAL FROM THE PIPING SYSTEM

### NOTICE

- No. 102 and 104 Fittings **DO NOT** need to be fully disassembled for removal. However, if a fitting is fully disassembled during maintenance or for any other reason, the following steps shall be completed.
- The fitting shall be reassembled, as shown in the steps below, before attempting to reinstall the product.

1. Inspect all components for any damage or wear. If any damage or wear is present, use a new Victaulic-supplied fitting assembly.

2. Check mating component ends, as described in step 2 on page 127.

### ! CAUTION

- A thin coat of a compatible lubricant shall be used to help prevent the gasket from pinching, rolling, or tearing during reassembly.
  - **DO NOT** use excessive lubricant on the gasket sealing lips and exterior.
- Failure to use a compatible lubricant may cause gasket damage, resulting in joint leakage and property damage.



3a. **VERIFY THAT THE CORRECT-SIZE GASKET IS BEING USED FOR REASSEMBLY.**

3b. **FOR REASSEMBLY OF NO. 102 AND 104 FITTINGS, LUBRICATE GASKET:** Apply a thin coat of a compatible lubricant to the gasket sealing lips and exterior portion outside the sealing lips, as shown to the left. Refer to the “Lubricant Compatibility for Gaskets” table on page 34.



4. **INSTALL GASKET INTO FIRST FITTING**

**HOUSING:** Install the gasket into one of the housings. Verify that the ends of the gasket are seated in the housing’s pockets, as shown to the left.



5. **INSTALL SECOND FITTING HOUSING:** Install the second fitting housing. Verify that the ends of the gasket are seated in the housings’ pockets.



6. **INSTALL BOLTS AND NUTS:** Install the bolts, and thread a nut onto each bolt. **NOTE:** Verify that the oval neck of each bolt seats properly in the bolt hole. **DO NOT** tighten the nuts completely. The bolt pads need to be set at a gap for reinstallation of the fitting. Two to three full bolt threads, exposed above each nut, will provide the proper gap.

7. Follow all steps of the applicable installation method section to complete the assembly.



# **Standard Couplings for OGS Grooved- End Mating Components**

**Preparatory Steps for  
Installation of Couplings  
Featured in this Section**

**Installation Instructions**

**Instructions for Reassembly**

# PREPARATORY STEPS FOR INSTALLATION OF COUPLINGS FEATURED IN THIS SECTION

## ! WARNING



- Read and understand all instructions before attempting to install any Victaulic products.
- Always verify that the piping system has been completely depressurized and drained immediately prior to installation, removal, adjustment, or maintenance of any Victaulic products.
- Confirm that any equipment, branch lines, or sections of piping that may have been isolated for/during testing or due to valve closures/positioning are identified, depressurized, and drained immediately prior to installation, removal, adjustment, or maintenance of any Victaulic products.
- These installation instructions are intended for an experienced, trained installer. The installer shall understand the use of this product and why it was specified for the particular application.
- The installer shall understand common industry safety standards and potential consequences of improper product installation.
- Wear safety glasses, hardhat, and foot protection.

Failure to follow these instructions could result in death or serious personal injury and property damage.

## ! WARNING

OGS Roll Groove Profile Shown



*Pipe and groove are not shown to scale*

- Products featured in this section shall be used **ONLY** with mating components that are prepared to Victaulic OGS groove specifications.

- **DO NOT** attempt to install these products on mating components that are prepared to any other groove specification.

Failure to follow these instructions could cause joint failure, resulting in death or serious personal injury and property damage.



**1. CHECK MATING COMPONENT ENDS:** The outside surface of the mating components, between the groove and the mating component ends, shall be generally free from indentations, projections, weld seam anomalies, and roll marks to ensure a leak-tight seal. All oil, grease, loose paint, dirt, and cutting particles shall be removed. Always verify that the correct groove profile is being used.

The mating components' outside diameter ("OD"), groove dimensions, and maximum allowable flare diameter shall be within the tolerances listed in this handbook for Victaulic OGS groove specifications.

## NOTICE

- Some Victaulic® FireLock™ products may be provided with pre-lubricated gaskets.
- Refer to the "NOTICE" and the "Dry Pipe Fire Protection Systems Notes" section on page 36 for additional information.

**2. CHECK GASKET:** Check the gasket to verify that it is suitable for the intended service. The color code identifies the material grade. Refer to page 32 for the "Gasket Color Code Reference" table. For complete compatibility information, reference Victaulic publications 05.01 and GSG-100, which can be downloaded at victaulic.com. For FireLock™ products, refer to the "NOTICE" on page 36 for important gasket information.

## ! CAUTION

- A thin coat of a compatible lubricant shall be applied to the gasket sealing lips and exterior to help prevent the gasket from pinching, rolling, or tearing during installation.
  - DO NOT use excessive lubricant on the gasket sealing lips and exterior.
- Failure to use a compatible lubricant may cause gasket damage, resulting in joint leakage and property damage.



**3. LUBRICATE GASKET:** Apply a thin coat of a compatible lubricant to the gasket sealing lips and exterior. Refer to the "Lubricant Compatibility for Gaskets" table on page 34.

**NOTE:** This step shall also be completed for FireLock™ products that meet any of the conditions listed in the "NOTICE" on page 36.

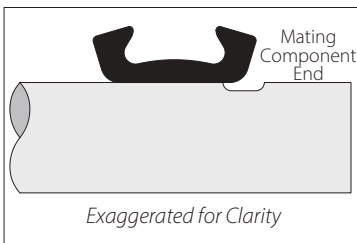

**4. INSTALL GASKET:** Install the gasket over the mating component end.

**For 14-inch/DN350 and larger coupling sizes:** It may be easier to turn the gasket inside out to install it over the mating component end. **NOTE:** Verify that the gasket does not overhang the mating component end.



**5. JOIN MATING COMPONENTS:** Align the centerlines of the two grooved mating component ends and bring them to within the appropriate pipe-end separation dimension. Slide the gasket into position and center it between the groove of each mating component. **NOTE:** Verify that no portion of the gasket extends into the groove of either mating component.

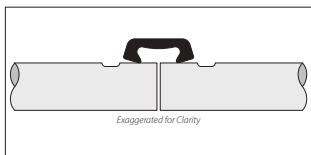

**5a. If the gasket was turned inside out in step 4:** Roll the gasket into position and center it between the groove of each mating component. **NOTE:** Verify that no portion of the gasket extends into the groove of either mating component.

**Style 005H** - FireLock™ Rigid Coupling

**Style 07** - Zero-Flex™ Rigid Coupling (12-inch/DN300 and Smaller Sizes)

**Style L07** - Zero-Flex™ Rigid Coupling (12-inch/DN300 and Smaller Sizes)

**Style 489** - Stainless Steel Rigid Coupling (4-inch/DN100 and Smaller Sizes)

## ! WARNING



- Read and understand all instructions before attempting to install any Victaulic products.
- Always verify that the piping system has been completely depressurized and drained immediately prior to installation, removal, adjustment, or maintenance of any Victaulic products.
- Confirm that any equipment, branch lines, or sections of piping that may have been isolated for/during testing or due to valve closures/positioning are identified, depressurized, and drained immediately prior to installation, removal, adjustment, or maintenance of any Victaulic products.
- Wear safety glasses, hardhat, and foot protection.
- Style 005H Victaulic® FireLock™ Rigid Couplings shall be used only in fire protection systems that are designed and installed in accordance with current, applicable National Fire Protection Association (NFPA 13, 13D, 13R, etc.) standards, or equivalent standards, and in accordance with applicable building and fire codes. These standards and codes contain important information regarding protection of systems from freezing temperatures, corrosion, mechanical damage, etc.
- These installation instructions are intended for an experienced, trained installer. The installer shall understand the use of this product and why it was specified for the particular application.
- The installer shall understand common industry safety standards and potential consequences of improper product installation.

Failure to follow installation requirements and local and national codes and standards could compromise system integrity or cause system failure, resulting in death or serious personal injury and property damage.

## NOTICE

- The photos in this section show installation of a Style 005H Coupling; however, the same steps apply to installation of Style 07, L07, and 489 Couplings in the size ranges listed above.

For Style 489 Couplings Supplied with Stainless Steel Bolts and Nuts:

- Apply an anti-seize compound to the bolt threads before installing the hardware.

1. Follow all instructions in the “Preparatory Steps” section on pages 148 – 149.



**2. TO FACILITATE ASSEMBLY:** One bolt can be inserted into the housings with the nut threaded loosely onto the bolt to allow for the “swing-over” feature, as shown. **NOTE:** The nut should be threaded no further than flush with the end of the bolt.

## CAUTION

- Verify that the gasket does not become rolled or pinched while installing the housings.

Failure to follow this instruction may cause gasket damage, resulting in joint leakage and property damage.

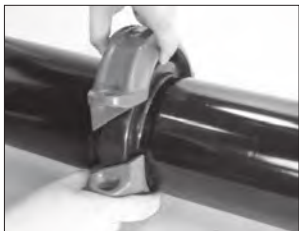

**3. INSTALL HOUSINGS:** Install the housings over the gasket. Verify that the housings' keys engage the grooves completely on both mating components.



**4. INSTALL REMAINING BOLT/NUT:** Install the remaining bolt, and thread the nut finger-tight onto the bolt. **NOTE:** Verify that the oval neck of each bolt seats properly in the bolt hole.

### IMPORTANT INFORMATION FOR USE OF STYLE 005H, 07, L07, AND 489 COUPLINGS WITH END CAPS:

## WARNING

- Always read and follow the "Victaulic End Cap Installation Safety Instructions" section in this handbook.

Failure to follow the "Victaulic End Cap Installation Safety Instructions" section could result in death or serious personal injury and property damage.

- Always confirm that any equipment, branch lines, or sections of piping that may have been isolated for/during testing or due to valve closures/positioning are identified, depressurized, and drained immediately prior to working with an end cap.

## WARNING

- Nuts shall be tightened evenly by alternating sides, maintaining nearly uniform bolt pad gaps, until metal-to-metal contact occurs at the angled bolt pads, as indicated in steps 5 and 6.
- Equal and positive or neutral offsets shall be present at the angled bolt pads, as indicated in steps 5 and 6.
- Keep hands away from coupling openings during tightening.

Failure to tighten nuts as instructed will cause increased loading of the hardware, resulting in the following conditions:

- Excessive bolt torque required to assemble the joint (incomplete assembly)
- Damage to the assembled joint (damaged or broken bolt pads or fractures to housings)
- Bolt damage or fracture
- Joint leakage and property damage
- A negative impact on system integrity
- Personal injury or death

DO NOT continue to tighten the nuts after the visual, metal-to-metal bolt pad inspection requirement is achieved.

- Failure to follow this instruction could result in the conditions listed above.

## NOTICE

- It is important to tighten the nuts evenly by alternating sides to prevent gasket pinching.
- An impact tool or standard socket wrench with a deep-well socket can be used to bring the bolt pads into metal-to-metal contact.
- Refer to the “Impact Tool Usage Guidelines” and “Impact Tool Selection” sections in this handbook, along with the applicable “Helpful Information” table below or on page 155.

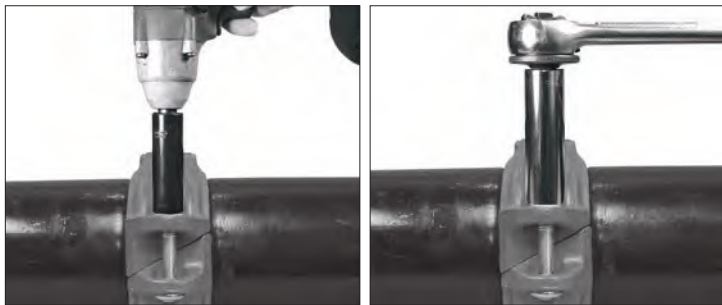

**5. TIGHTEN NUTS:** Using an impact tool or a standard socket wrench with a deep-well socket, tighten the nuts evenly by alternating sides, maintaining nearly uniform bolt pad gaps, until metal-to-metal contact occurs at the angled bolt pads. Equal and positive or neutral offsets shall be present at the bolt pads. Verify that the oval neck of each bolt seats properly in the bolt holes. DO NOT continue to tighten the nuts after the visual, metal-to-metal bolt pad inspection requirement is achieved. **If you suspect that any hardware has been over-tightened (as indicated by a bend in the bolt, bulging of the nut at the bolt pad interface, or damage to the bolt pad, etc.), the entire coupling assembly shall be replaced immediately.** Refer to the “Impact Tool Usage Guidelines” and “Impact Tool Selection” sections in this handbook, along with the applicable “Helpful Information” table below or on page 155.

**5a. FOR STYLE 489 COUPLINGS ONLY:** To complete the assembly, apply torque to each nut with a torque wrench. Refer to the “Style 489 Helpful Information and Assembly Torque Requirements” table below, along with the “Torque Wrench Selection” section in this handbook.

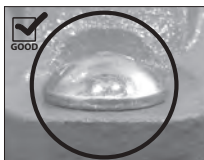

OVAL NECK OF BOLT  
SEATED PROPERLY



OVAL NECK OF BOLT  
NOT SEATED PROPERLY

### Style 489 Helpful Information and Assembly Torque Requirements

Nominal Pipe Size inches/DN	Actual Pipe Outside Diameter inches/mm	Nut Size inches/ Metric	Deep-Well Socket Size inches/mm	Required Assembly Torques
1 ½ – 2 DN40 – DN50	1.900 – 2.375 48.3 – 60.3	¾ M10	1¼ 17	18 – 22 ft-lbs 25 – 30 N•m
2½	2.875 73.0	¾ M10	1¼ 17	18 – 22 ft-lbs 25 – 30 N•m
DN65	3.000 76.1	¾ M10	1¼ 17	18 – 22 ft-lbs 25 – 30 N•m
3 – 4 DN80 – DN100	3.500 – 4.500 88.9 – 114.3	½ M12	7⁄8 22	45 – 50 ft-lbs 60 – 68 N•m



## WARNING

- Visual inspection of each joint is required.
- Improperly assembled joints shall be corrected before the system is filled, tested, or placed into service.
- Any components that exhibit physical damage due to improper assembly shall be replaced before the system is filled, tested, or placed into service.

Failure to follow these instructions could cause joint failure, resulting in death or serious personal injury and property damage.

6. Visually inspect each bolt pad location at every joint to verify that metal-to-metal contact is achieved across the entire bolt pad section. Equal and positive or neutral offsets shall be present at each bolt pad location.

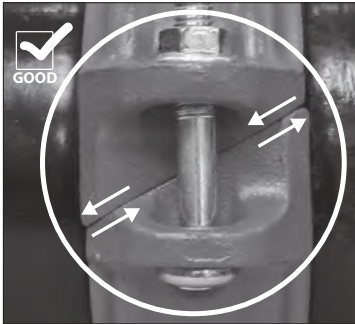

**PROPERLY ASSEMBLED JOINT  
METAL-TO-METAL CONTACT AT ANGLED  
BOLT PADS WITH EQUAL, POSITIVE  
OFFSETS AT THE BOLT PADS**

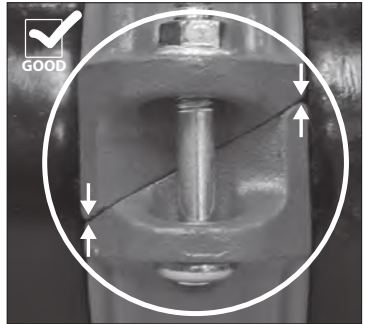

**PROPERLY ASSEMBLED JOINT  
METAL-TO-METAL CONTACT AT ANGLED  
BOLT PADS WITH EQUAL, NEUTRAL  
OFFSETS AT THE BOLT PADS**



**IMPROPERLY ASSEMBLED JOINT  
BOLT PAD GAP**

Bolt pad gaps occur when the nuts are not tightened sufficiently or if the hardware is not tightened evenly by alternating sides. Refer to the “Improperly Assembled Joint – Over-Shifted” section below. In addition, refer to the “Impact Tool Usage Guidelines” and “Impact Tool Selection” sections in this handbook. This represents an improper assembly, which could result in joint failure, property damage, serious personal injury, or death.

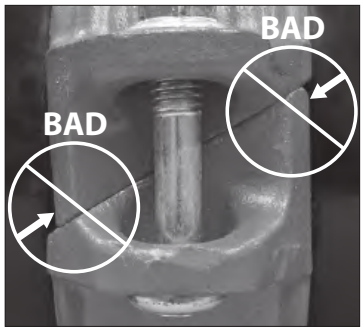

**IMPROPERLY ASSEMBLED JOINT  
NEGATIVE OFFSET**

Negative bolt pad offsets occur when the nuts are not tightened evenly, which produces over-tightening of one side and under-tightening of the other side. In addition, negative offsets occur if both nuts are under-tightened. Refer to the “Impact Tool Usage Guidelines” and “Impact Tool Selection” sections in this handbook. This represents an improper assembly, which could result in joint failure, property damage, serious personal injury, or death.

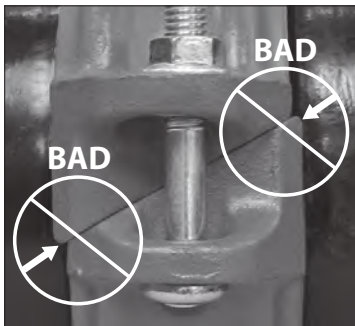

**IMPROPERLY ASSEMBLED JOINT  
OVER-SHIFTED**

Over-shifting of an angled bolt pad results in an offset that prevents metal-to-metal contact and equal and positive or neutral offset at the opposite angled bolt pad. This occurs when the hardware is not tightened evenly by alternating sides. Attempting to tighten the hardware on one side while the other side is over-shifted will result in bolt torque that exceeds the “Maximum Allowable Bolt Torque” values specified in the “Helpful Information” table in this section. Refer to the “Impact Tool Usage Guidelines” and “Impact Tool Selection” sections in this handbook. This represents an improper assembly, which could result in joint failure, property damage, serious personal injury, or death.

Style 005H, 07, and L07 Helpful Information

Nominal Pipe Size inches/DN	Actual Pipe Outside Diameter inches/mm	Style 005H			Style 07/L07‡		
		Nut Size inches/Metric	Deep-Well Socket Size inches/mm	Max. Allow. Bolt Torque*	Nut Size inches/Metric	Deep-Well Socket Size inches/mm	Max. Allow. Bolt Torque*
1 DN25	1.315 33.7	—	—	—	3/8 M10	1 1/16 17	55 ft-lbs 75 N•m
1 1/4 DN32	1.660 42.4	3/8 M10	9/16 15	55 ft-lbs 75 N•m	3/8 M10	1 1/16 17	55 ft-lbs 75 N•m
1 1/2 DN40	1.900 48.3	3/8 M10	9/16 15	55 ft-lbs 75 N•m	3/8 M10	1 1/16 17	55 ft-lbs 75 N•m
2 DN50	2.375 60.3	3/8 M10	9/16 15	55 ft-lbs 75 N•m	1/2 M12	7/8 22	135 ft-lbs 183 N•m
2 1/2	2.875 73.0	3/8 M10	9/16 15	55 ft-lbs 75 N•m	1/2 M12	7/8 22	135 ft-lbs 183 N•m
DN65	3.000 76.1	3/8 M10	9/16 15	55 ft-lbs 75 N•m	1/2 M12	7/8 22	135 ft-lbs 183 N•m
3 DN80	3.500 88.9	3/8 M10	9/16 15	55 ft-lbs 75 N•m	1/2 M12	7/8 22	135 ft-lbs 183 N•m
4 DN100	4.500 114.3	3/8 M10	9/16 15	55 ft-lbs 75 N•m	1/2 M12	7/8 22	135 ft-lbs 183 N•m
	4.250 108.0	3/8 M10	9/16 15	55 ft-lbs 75 N•m	1/2 M12	7/8 22	135 ft-lbs 183 N•m
	5.250 133.0	1/2 M12	3/4 18	135 ft-lbs 183 N•m	5/8 M16	1 1/16 27	235 ft-lbs 319 N•m
DN125	5.500 139.7	1/2 M12	3/4 18	135 ft-lbs 183 N•m	5/8 M16	1 1/16 27	235 ft-lbs 319 N•m
5	5.563 141.3	1/2 M12	3/4 18	135 ft-lbs 183 N•m	5/8 M16	1 1/16 27	235 ft-lbs 319 N•m
	6.250 159.0	1/2 M12	3/4 18	135 ft-lbs 183 N•m	5/8 M16	1 1/16 27	235 ft-lbs 319 N•m
	6.500 165.1	1/2 M12	3/4 18	135 ft-lbs 183 N•m	5/8 M16	1 1/16 27	235 ft-lbs 319 N•m
6 DN150	6.625 168.3	1/2 M12	3/4 18	135 ft-lbs 183 N•m	5/8 M16	1 1/16 27	235 ft-lbs 319 N•m
#	8.515 216.3	5/8 M16	15/16 24	235 ft-lbs 319 N•m	—	—	—
8 DN200	8.625 219.1	5/8 M16	15/16 24	235 ft-lbs 319 N•m	3/4 M20	1 1/4 32	425 ft-lbs 576 N•m
#	10.528 267.4	—	—	—	7/8 M22	1 7/16 36	675 ft-lbs 915 N•m
10 DN250	10.750 273.0	—	—	—	7/8 M22	1 7/16 36	675 ft-lbs 915 N•m
#	12.539 318.5	—	—	—	7/8 M22	1 7/16 36	675 ft-lbs 915 N•m
12 DN300	12.750 323.9	—	—	—	7/8 M22	1 7/16 36	675 ft-lbs 915 N•m

‡ The Style L07 may not be available in all sizes listed.

# Applies to JIS metric pipe sizes 200A, 250A, and 300A, respectively (JIS Specification G 3452; G3454).

\* Maximum allowable bolt torque values have been derived from actual test data.

**NOTE:** For 14 – 24-inch/DN350 – DN600 sizes, refer to the Style W07 AGS Rigid Coupling instructions in this handbook.

**Style HP-70** - Rigid Coupling (12-inch/DN300 and Smaller Sizes)

**Style 89** - Rigid Coupling

**Style 889** - Rigid Coupling for Potable Water Applications

**Style 489** - Rigid Stainless Steel Coupling (5-inch, DN125, and Larger Sizes)

**Style 489DX** - Duplex Stainless Steel Rigid Coupling

## **WARNING**



- Read and understand all instructions before attempting to install any Victaulic products.
- Always verify that the piping system has been completely depressurized and drained immediately prior to installation, removal, adjustment, or maintenance of any Victaulic products.
- Confirm that any equipment, branch lines, or sections of piping that may have been isolated for/during testing or due to valve closures/positioning are identified, depressurized, and drained immediately prior to installation, removal, adjustment, or maintenance of any Victaulic products.
- These installation instructions are intended for an experienced, trained installer. The installer shall understand the use of this product and why it was specified for the particular application.
- The installer shall understand common industry safety standards and potential consequences of improper product installation.
- Wear safety glasses, hardhat, and foot protection.

Failure to follow these instructions could result in death or serious personal injury and property damage.

## **NOTICE**

- The photos in this section show installation of a Style 889 Coupling; however, the same steps apply to installation of Style HP-70, 89, 489, and 489DX Couplings in the size ranges listed above.

For Style HP-70 Couplings:

- Always verify the gasket style that is provided with the coupling. If the gasket is an EndSeal™ design, the HP-70ES instructions on pages 188 – 192 of this handbook shall be followed.

For Style 489/489DX Couplings Supplied with Stainless Steel Bolts and Nuts:

- Apply an anti-seize compound to the bolt threads before installing the hardware.

1. Follow all instructions in the “Preparatory Steps” section on pages 148 – 149.

## **CAUTION**

- Verify that the gasket does not become rolled or pinched while installing the housings.

Failure to follow this instruction may cause gasket damage, resulting in joint leakage and property damage.

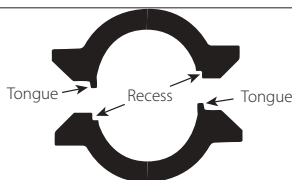

2. **INSTALL HOUSINGS:** Install the housings over the gasket with the tongue-and-recess features mated properly (tongue in recess). Verify that the housings' keys engage the grooves completely on both mating components.



**3. INSTALL BOLTS/NUTS:** Install the bolts, and thread a nut finger-tight onto each bolt. **NOTE:** Verify that the oval neck of each bolt seats properly in the bolt hole.

If couplings are special-ordered with stainless steel bolts and nuts, an anti-seize compound shall be applied to the bolt threads.

#### IMPORTANT INFORMATION FOR USE OF STYLE HP-70, 89, 489, 489DX, AND 889 COUPLINGS WITH END CAPS:

### **WARNING**

- Always read and follow the “Victaulic End Cap Installation Safety Instructions” section in this handbook.

Failure to follow the “Victaulic End Cap Installation Safety Instructions” section could result in death or serious personal injury and property damage.

- Always confirm that any equipment, branch lines, or sections of piping that may have been isolated for/during testing or due to valve closures/positioning are identified, depressurized, and drained immediately prior to working with an end cap.

### **WARNING**

- The housings’ tongue-and-recess features shall be mated properly (tongue in recess).
- Nuts shall be tightened evenly by alternating sides, maintaining nearly uniform bolt pad gaps, until all assembly requirements specified in steps 4 and 5 are achieved.
- Keep hands away from coupling openings during tightening.

Failure to tighten nuts as instructed will cause increased loading of the hardware, resulting in the following conditions:

- Excessive bolt torque required to assemble the joint (incomplete assembly)
- Damage to the assembled joint (damaged or broken bolt pads or fractures to housings)
- Bolt damage or fracture
- Joint leakage and property damage
- A negative impact on system integrity
- Personal injury or death

**DO NOT** continue to tighten the nuts after the assembly requirements specified in steps 4 and 5 are achieved.

- Failure to follow this instruction could result in the conditions listed above.

### **NOTICE**

- It is important to tighten the nuts evenly by alternating sides to prevent gasket pinching.
- An impact tool or standard socket wrench with a deep-well socket can be used to tighten the hardware.
- Refer to the “Impact Tool Usage Guidelines,” “Impact Tool Selection,” and “Torque Wrench Selection” sections in this handbook. In addition, refer to the “Assembly Torque Requirements” table on page 159 and the “Helpful Information” table on page 160.

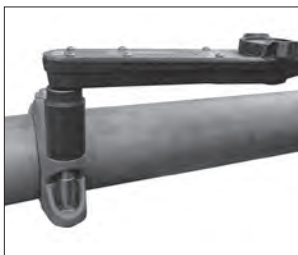

**4. TIGHTEN NUTS:** Using an impact tool or a standard socket wrench with a deep-well socket, tighten the nuts evenly by alternating sides until the gaps are equal at the bolt pads. Verify that the oval neck of each bolt seats properly in the bolt holes. **To complete the assembly, apply torque to each nut with a torque wrench.** Refer to the "NOTICE" below for exceptions, the "Assembly Torque Requirements" table on the following page, and the "Torque Wrench Selection" section in this handbook.

If you suspect that any hardware has been over-tightened (as indicated by a bend in the bolt, bulging of the nut at the bolt pad interface, or damage to the bolt pad, etc.), the entire coupling assembly shall be replaced immediately.

## NOTICE

- Style HP-70 Couplings in 6 – 12-inch/DN150 – DN300 sizes do not have a torque requirement. However, the nuts shall be tightened evenly by alternating sides, maintaining nearly uniform bolt pad gaps, until metal-to-metal contact occurs at the bolt pads. It is important to tighten the nuts evenly by alternating sides to prevent gasket pinching. **DO NOT** continue to tighten the nuts after the visual, metal-to-metal bolt pad inspection requirement is achieved.



OVAL NECK OF BOLT SEATED PROPERLY



OVAL NECK OF BOLT NOT SEATED PROPERLY

## ! WARNING

- Visual inspection of each joint is required.
- Improperly assembled joints shall be corrected before the system is filled, tested, or placed into service.
- Any components that exhibit physical damage due to improper assembly shall be replaced before the system is filled, tested, or placed into service.

Failure to follow these instructions could cause joint failure, resulting in death or serious personal injury and property damage.

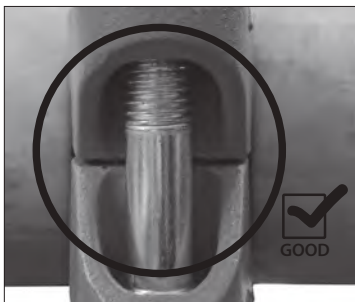

5. Visually inspect each bolt pad location at every joint to verify that proper assembly is achieved (refer to the "NOTICE" above for Style HP-70 Couplings in 6 – 12-inch/ DN150 – DN300 sizes).

## Assembly Torque Requirements

Nom. Pipe Size inches/DN	Actual Pipe Outside Diameter inches/mm	Required Assembly Torques			
		Style HP-70	Style 89/889*	Style 489	Style 489DX
2 DN50	2.375 60.3	60 – 80 ft-lbs 81 – 109 N•m	60 – 90 ft-lbs 81 – 122 N•m	—	45 – 60 ft-lbs 61 – 81 N•m
2 ½	2.875 73.0	60 – 80 ft-lbs 81 – 109 N•m	60 – 90 ft-lbs 81 – 122 N•m	—	60 – 90 ft-lbs 81 – 122 N•m
DN65	3.000 76.1	—	60 – 90 ft-lbs 81 – 122 N•m	—	60 – 90 ft-lbs 81 – 122 N•m
3 DN80	3.500 88.9	60 – 80 ft-lbs 81 – 109 N•m	60 – 90 ft-lbs 81 – 122 N•m	—	60 – 90 ft-lbs 81 – 122 N•m
4 DN100	4.500 114.3	60 – 80 ft-lbs 81 – 109 N•m	85 – 125 ft-lbs 115 – 170 N•m	—	85 – 125 ft-lbs 115 – 170 N•m
DN125	5.500 139.7	—	85 – 125 ft-lbs 115 – 170 N•m	75 – 100 ft-lbs 102 – 136 N•m	85 – 125 ft-lbs 115 – 170 N•m
5	5.563 141.3	—	85 – 125 ft-lbs 115 – 170 N•m	85 – 125 ft-lbs 115 – 170 N•m	—
	6.500 165.1	—	175 – 250 ft-lbs 237 – 339 N•m	125 – 200 ft-lbs 170 – 271 N•m	125 – 200 ft-lbs 170 – 271 N•m
6 DN150	6.625 168.3	See Notice Below	175 – 250 ft-lbs 237 – 339 N•m	125 – 200 ft-lbs 170 – 271 N•m	125 – 200 ft-lbs 170 – 271 N•m
	8.515 216.3	—	200 – 300 ft-lbs 271 – 407 N•m	200 – 300 ft-lbs 271 – 407 N•m	—
8 DN200	8.625 219.1	See Notice Below	500 ft-lbs 678 N•m	200 – 300 ft-lbs 271 – 407 N•m	200 – 300 ft-lbs 271 – 407 N•m
	10.528 267.4	—	250 – 350 ft-lbs 339 – 475 N•m	200 – 300 ft-lbs 271 – 407 N•m	—
10 DN250	10.750 273.0	See Notice Below	500 ft-lbs 678 N•m	200 – 300 ft-lbs 271 – 407 N•m	250 – 350 ft-lbs 339 – 475 N•m
	12.539 318.5	—	250 – 350 ft-lbs 339 – 475 N•m	200 – 300 ft-lbs 271 – 407 N•m	—
12 DN300	12.750 323.9	See Notice Below	500 ft-lbs 678 N•m	200 – 300 ft-lbs 271 – 407 N•m	250 – 350 ft-lbs 339 – 475 N•m
14 DN350	14.000 323.9	—	—	200 – 300 ft-lbs 271 – 407 N•m	250 – 350 ft-lbs 339 – 475 N•m

\* The Style 889 may not be available in all sizes listed.

### NOTICE

- **Style HP-70 Couplings in 6 – 12-inch/DN150 – DN300 sizes do not have a torque requirement. However, the nuts shall be tightened evenly by alternating sides, maintaining nearly uniform bolt pad gaps, until metal-to-metal contact occurs at the bolt pads. It is important to tighten the nuts evenly by alternating sides to prevent gasket pinching. DO NOT continue to tighten the nuts after the visual, metal-to-metal bolt pad inspection requirement is achieved.**

## Helpful Information

Nominal Pipe Size inches/ DN	Actual Pipe Outside Diameter inches/mm	Style HP-70		Style 89/889*		Style 489		Style 489DX	
		Nut Size inches/ Metric	Deep-Well Socket Size inches/ mm	Nut Size inches/ Metric	Deep-Well Socket Size inches/ mm	Nut Size inches/ Metric	Deep-Well Socket Size inches/ mm	Nut Size inches/ Metric	Deep-Well Socket Size inches/ mm
2 DN50	2.375 60.3	5/8 M16	1 1/16 27	5/8 M16	1 1/16 27	—	—	1/2 M12	7/8 19
2 1/2	2.375 60.3	5/8 M16	1 1/16 27	5/8 M16	1 1/16 27	—	—	5/8 M16	1 1/16 27
DN65	3.000 76.1	—	—	5/8 M16	1 1/16 27	—	—	5/8 M16	1 1/16 27
3 DN80	3.500 88.9	5/8 M16	1 1/16 27	5/8 M16	1 1/16 27	—	—	5/8 M16	1 1/16 27
4 DN100	4.500 114.3	3/4 M20	1 1/4 32	3/4 M20	1 1/4 32	—	—	3/4 M20	1 1/4 32
DN125	5.500 139.7	—	—	3/4 M20	1 1/4 32	3/4 M20	1 1/4 32	3/4 M20	1 1/4 32
5	5.563 141.3	—	—	3/4 M20	1 1/4 32	3/4 M20	1 1/4 32	—	—
	6.500 165.1	—	—	7/8 M22	1 7/16 36	7/8 M22	1 7/16 36	7/8 M22	1 7/16 36
6 DN150	6.625 168.3	7/8 M22	1 7/16 36	7/8 M22	1 7/16 36	7/8 M22	1 7/16 36	7/8 M22	1 7/16 36
	8.515 216.3	—	—	1 M24	1 5/8 41	1 M24	1 5/8 41	—	—
8 DN200	8.625 219.1	1 M24	1 5/8 41	1 M24	1 5/8 41	1 M24	1 5/8 41	1 M24	1 5/8 41
	10.528 267.4	—	—	1 M24	1 5/8 41	1 M24	1 5/8 41	—	—
10 DN250	10.750 273.0	1 M24	1 5/8 41	1 M24	1 5/8 41	1 M24	1 5/8 41	1 M24	1 5/8 41
	12.539 318.5	—	—	1 M24	1 5/8 41	1 M24	1 5/8 41	—	—
12 DN300	12.750 323.9	1 M24	1 5/8 41	1 M24	1 5/8 41	1 M24	1 5/8 41	1 M24	1 5/8 41

\* The Style 889 may not be available in all sizes listed.

**Style HP-70** - Rigid Coupling (14-inch/DN350 and Larger Sizes)

**Style 77** - Flexible Coupling (14-inch/DN350 and Larger Sizes - Four or Six Housings)

**Style 77S** - Stainless Steel Flexible Coupling (16-inch/DN400 and Larger Sizes - Four Housings)

## ! WARNING



- Read and understand all instructions before attempting to install any Victaulic products.
- Always verify that the piping system has been completely depressurized and drained immediately prior to installation, removal, adjustment, or maintenance of any Victaulic products.
- Confirm that any equipment, branch lines, or sections of piping that may have been isolated for/during testing or due to valve closures/positioning are identified, depressurized, and drained immediately prior to installation, removal, adjustment, or maintenance of any Victaulic products.
- These installation instructions are intended for an experienced, trained installer. The installer shall understand the use of this product and why it was specified for the particular application.
- The installer shall understand common industry safety standards and potential consequences of improper product installation.
- Wear safety glasses, hardhat, and foot protection.

Failure to follow these instructions could result in death or serious personal injury and property damage.

## NOTICE

- The following installation steps feature photos of a Style 77 Coupling; however, the same steps apply to installation of Style 77S and HP-70 Couplings in the size ranges listed above.
- Couplings are cast in multiple housings to ease handling.

1. Follow all instructions in the “Preparatory Steps” section on pages 148 – 149.

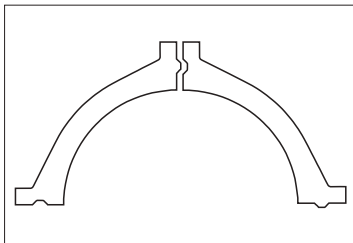

**2. ASSEMBLE HOUSINGS:** Assemble the housings into two equal halves. Install a bolt into each hole location at the bolt pads and thread a nut finger-tight onto each bolt. Verify that the oval neck of each bolt seats properly in the bolt hole. Tighten the nuts until metal-to-metal contact occurs at the bolt pads, then back the nuts off a full turn to provide spacing between the bolt pads.

**FOR STYLE 77 COUPLINGS WITH BOLT PADS THAT CONTAIN A TONGUE-AND-RECESS FEATURE:** Assemble the housings with the tongue-and-recess features mated properly (tongue in recess), as shown above.

## CAUTION

- Verify that the gasket does not become rolled or pinched while installing the housings.

Failure to follow this instruction may cause gasket damage, resulting in joint leakage and property damage.



**3a. INSTALL FIRST PRE-ASSEMBLED HALF:** Install the first pre-assembled half over the gasket. Verify that the housings' keys engage the grooves completely on both mating components.

**3b. INSTALL REMAINING PRE-ASSEMBLED HALF:** Install the remaining pre-assembled half over the gasket. Verify that the housings' keys engage the grooves completely on both mating components. While supporting the weight of the assembly, install the remaining bolts, and thread a nut finger-tight onto each bolt. **NOTE:** Verify that the oval neck of each bolt seats properly in the bolt hole.

### IMPORTANT INFORMATION FOR USE OF STYLE HP-70, 77, AND 77S COUPLINGS WITH END CAPS:

## WARNING

- Always read and follow the "Victaulic End Cap Installation Safety Instructions" section in this handbook.

Failure to follow the "Victaulic End Cap Installation Safety Instructions" section could result in death or serious personal injury and property damage.

- Always confirm that any equipment, branch lines, or sections of piping that may have been isolated for/during testing or due to valve closures/positioning are identified, depressurized, and drained immediately prior to working with an end cap.

## WARNING

- Nuts shall be tightened evenly by alternating bolt pad locations, maintaining nearly uniform bolt pad gaps, until all assembly requirements specified in steps 4 and 5 are achieved.
- Keep hands away from coupling openings during tightening.

Failure to tighten nuts as instructed will cause increased loading of the hardware, resulting in the following conditions:

- Excessive bolt torque required to assemble the joint (incomplete assembly)
- Damage to the assembled joint (damaged or broken bolt pads or fractures to housings)
- Bolt damage or fracture
- Joint leakage and property damage
- A negative impact on system integrity
- Personal injury or death

DO NOT continue to tighten the nuts after the assembly requirements specified in steps 4 and 5 are achieved.

- Failure to follow this instruction could result in the conditions listed above.

## NOTICE

- It is important to tighten the nuts evenly by alternating bolt pad locations to prevent gasket pinching.
- An impact tool or standard socket wrench with a deep-well socket can be used to tighten the hardware.
- Refer to the “Impact Tool Usage Guidelines” and “Impact Tool Selection” sections in this handbook, along with the applicable “Helpful Information” table on the following page.



**4. TIGHTEN NUTS:** Using an impact tool or a standard socket wrench with a deep-well socket, tighten all nuts evenly by alternating bolt pad locations, maintaining nearly uniform bolt pad gaps, until metal-to-metal contact occurs at each bolt pad. Verify that the oval neck of each bolt seats properly in the bolt holes.

**FOR STYLE HP-70 COUPLINGS:** To complete the assembly, apply torque to each nut with a torque wrench. Refer to the “Style HP-70 Helpful Information and Assembly Torque Requirements” table on the following page, along with the “Torque Wrench Selection” section in this handbook.

**FOR STYLE 77 COUPLINGS:** DO NOT continue to tighten the nuts after the visual, metal-to-metal bolt pad inspection requirement is achieved. Refer to the applicable “Helpful Information” table on the following page.

If you suspect that any hardware has been over-tightened (as indicated by a bend in the bolt, bulging of the nut at the bolt pad interface, or damage to the bolt pad, etc.), the entire coupling assembly shall be replaced immediately. Refer to the “Impact Tool Usage Guidelines” and “Impact Tool Selection” sections in this handbook.

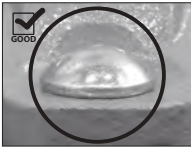

OVAL NECK OF BOLT SEATED PROPERLY



OVAL NECK OF BOLT NOT SEATED PROPERLY

## ! WARNING

- Visual inspection of each joint is required.
- Improperly assembled joints shall be corrected before the system is filled, tested, or placed into service.
- Any components that exhibit physical damage due to improper assembly shall be replaced before the system is filled, tested, or placed into service.

Failure to follow these instructions could cause joint failure, resulting in death or serious personal injury and property damage.

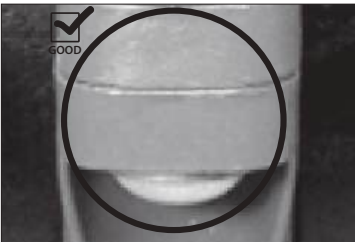

5. Visually inspect each bolt pad location at every joint to verify that proper assembly is achieved.

## Style HP-70 Helpful Information and Assembly Torque Requirements

Nominal Pipe Size inches/DN	Actual Pipe Outside Diameter inches/mm	Nut Size inches/Metric	Deep-Well Socket Size inches/mm	Required Assembly Torques
14 DN350	14.000 355.6	1 ¼ M30	2 50	600 ft-lbs 814 N•m
16 DN400	16.000 406.4	1 ¼ M30	2 50	700 ft-lbs 949 N•m

## Style 77 Helpful Information

Nominal Pipe Size inches/DN	Actual Pipe Outside Diameter inches/mm	Nut Size inches/Metric	Deep-Well Socket Size inches/mm	Maximum Allowable Bolt Torque*
14 – 18 DN350 – DN450	14.000 – 18.000 355.6 – 457	1 M24	1 ⅝ 41	875 ft-lbs 1186 N•m
	14.842 377.0	1 M24	1 ⅝ 41	875 ft-lbs 1186 N•m
	16.771 426.0	1 M24	1 ⅝ 41	875 ft-lbs 1186 N•m
	18.897 480.0	1 ⅝ M27	1 ⅜ 46	875 ft-lbs 1186 N•m
20 – 24 DN500 – DN600	20.000 – 24.000 508 – 610	1 ⅝ M27	1 ⅜ 46	875 ft-lbs 1186 N•m
	20.866 530.0	1 ⅝ M27	1 ⅜ 46	875 ft-lbs 1186 N•m
	24.803 630.0	1 ⅝ M27	1 ⅜ 46	875 ft-lbs 1186 N•m
28 – 30 DN700 – DN750	28.000 – 30.000 711 – 762	1 M24	1 ⅝ 41	875 ft-lbs 1186 N•m

\* Maximum allowable bolt torque values have been derived from actual test data.

## Style 77S Helpful Information

Nominal Pipe Size inches/DN	Actual Pipe Outside Diameter inches/mm	Nut Size inches/Metric	Deep-Well Socket Size inches/mm	Maximum Allowable Bolt Torque*
16 – 18 DN400 – DN450	16.000 – 18.000 406.4 – 457.0	1 M24	1 ⅝ 41	875 ft-lbs 1186 N•m

\* Maximum allowable bolt torque values have been derived from actual test data.



**! WARNING**



- Read and understand all instructions before attempting to install any Victaulic products.
  - Always verify that the piping system has been completely depressurized and drained immediately prior to installation, removal, adjustment, or maintenance of any Victaulic products.
  - Confirm that any equipment, branch lines, or sections of piping that may have been isolated for/during testing or due to valve closures/positioning are identified, depressurized, and drained immediately prior to installation, removal, adjustment, or maintenance of any Victaulic products.
  - These installation instructions are intended for an experienced, trained installer. The installer shall understand the use of this product and why it was specified for the particular application.
  - The installer shall understand common industry safety standards and potential consequences of improper product installation.
  - Wear safety glasses, hardhat, and foot protection.
- Failure to follow these instructions could result in death or serious personal injury and property damage.

**NOTICE**

- Style 72 Outlet Couplings are not designed for use on vacuum service.
- Style 72 Outlet Couplings are not recommended for use on stainless steel mating components.
- End caps **SHALL NOT** be installed in Style 72 Outlet Coupling runs in systems where vacuums may develop.
- The Style 72 gasket contains a plated “neck ring” to aid sealing. **DO NOT** remove this ring, since leakage may result.
- Style 72 Outlet Couplings are primarily intended for flow that goes out through the outlet. Flow that goes into the outlet shall not exceed 7 feet per second/ 2.1 meters per second.

1. Follow steps 1 – 3 in the “Preparatory Steps” section on pages 148 – 149.



**2. INSTALL GASKET:** Install the gasket onto the mating component end so that the lips on one side cover the area between the groove and the mating component end. **NOTE:** The mating component end should not contact the reinforcement ribs inside the gasket.



**3. JOIN MATING COMPONENTS:** Align the centerlines of the two grooved mating component ends and bring them to within the appropriate pipe-end separation dimension. Slide the gasket into position and center it between the groove of each mating component. **NOTE:** Verify that no portion of the gasket extends into the groove of either mating component.

## CAUTION

- Verify that the gasket does not become rolled or pinched while installing the housings.

Failure to follow this instruction may cause gasket damage, resulting in joint leakage and property damage.

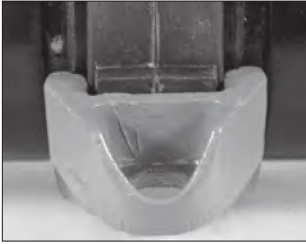

**4. INSTALL LOWER HOUSING:** Install the lower housing (without the outlet) around the lower portion of the gasket. Verify that the housings' keys engage the grooves completely on both mating components. **NOTE:** Tabs are located on the gasket, which are designed to rest in the recesses on both the upper and lower housings. These tabs ensure proper gasket positioning within the housings.

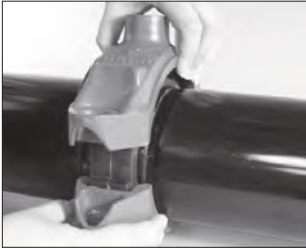

**5. INSTALL UPPER HOUSING:** Install the upper housing over the gasket. Verify that the housings' keys engage the grooves completely on both mating components. Inspect the outlet opening to verify that the outlet neck of the gasket is positioned properly in the upper housing.



**6. INSTALL BOLTS/NUTS:** Install the bolts, and thread a nut finger-tight onto each bolt. **NOTE:** Verify that the oval neck of each bolt seats properly in the bolt hole.

### IMPORTANT INFORMATION FOR USE OF STYLE 72 COUPLINGS WITH END CAPS:

## WARNING

- Always read and follow the "Victaulic End Cap Installation Safety Instructions" section in this handbook.

Failure to follow the "Victaulic End Cap Installation Safety Instructions" section could result in death or serious personal injury and property damage.

- End caps SHALL NOT be installed in Style 72 Outlet Coupling runs in systems where vacuums may develop.
- Always confirm that any equipment, branch lines, or sections of piping that may have been isolated for/during testing or due to valve closures/positioning are identified, depressurized, and drained immediately prior to working with an end cap.

## ! WARNING

- Nuts shall be tightened evenly by alternating sides, maintaining nearly uniform bolt pad gaps, until metal-to-metal contact occurs at the bolt pads, as indicated in steps 7 and 8.
- Keep hands away from coupling openings during tightening.

Failure to tighten nuts as instructed will cause increased loading of the hardware, resulting in the following conditions:

- Excessive bolt torque required to assemble the joint (incomplete assembly)
- Damage to the assembled joint (damaged or broken bolt pads or fractures to housings)
- Bolt damage or fracture
- Joint leakage and property damage
- A negative impact on system integrity
- Personal injury or death

DO NOT continue to tighten the nuts after the visual, metal-to-metal bolt pad inspection requirement is achieved.

- Failure to follow this instruction could result in the conditions listed above.

## NOTICE

- It is important to tighten the nuts evenly by alternating sides to prevent gasket pinching.
- An impact tool or standard socket wrench with a deep-well socket can be used to bring the bolt pads into metal-to-metal contact.
- Refer to the “Impact Tool Usage Guidelines” and “Impact Tool Selection” sections in this handbook, along with the “Helpful Information” table on the following page.



**7. TIGHTEN NUTS:** Using an impact tool or a standard socket wrench with a deep-well socket, tighten the nuts evenly by alternating sides, maintaining nearly uniform bolt pad gaps, until metal-to-metal contact occurs at the bolt pads. Verify that the oval neck of each bolt seats properly in the bolt holes. DO NOT continue to tighten the nuts after the visual, metal-to-metal bolt pad inspection requirement is achieved.

If you suspect that any hardware has been over-tightened (as indicated by a bend in the bolt, bulging of the nut at the bolt pad interface, or damage to the bolt pad, etc.), the entire coupling assembly shall be replaced immediately. Refer to the “Impact Tool Usage Guidelines” and “Impact Tool Selection” sections in this handbook, along with the “Helpful Information” table on the following page.

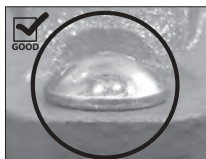

OVAL NECK OF BOLT SEATED PROPERLY



OVAL NECK OF BOLT NOT SEATED PROPERLY

## ! WARNING

- Visual inspection of each joint is required.
- Improperly assembled joints shall be corrected before the system is filled, tested, or placed into service.
- Any components that exhibit physical damage due to improper assembly shall be replaced before the system is filled, tested, or placed into service.

Failure to follow these instructions could cause joint failure, resulting in death or serious personal injury and property damage.



8. Visually inspect each bolt pad location at every joint to verify that metal-to-metal contact is achieved across the entire bolt pad section.

9. Make threaded outlet connections by following standard threading practices and grooved outlet connections by following the applicable coupling instructions in this handbook.

### Helpful Information

Nominal Pipe Size inches/DN		Actual Pipe Outside Diameter inches/mm		Nut Size inches/ Metric	Deep-Well Socket Size inches/ mm	Maximum Allowable Bolt Torque*
1 1/2 DN40	x 1/2 – 1 DN15 – DN25	1.900 48.3	x 0.840 – 1.315 21.3 – 33.7	3/8 M10	1 1/16 17	55 ft-lbs 75 N•m
2 DN50	x 1/2 – 1 DN15 – DN25	2.375 60.3	x 0.840 – 1.315 21.3 – 33.7	3/8 M10	1 1/16 17	55 ft-lbs 75 N•m
2 1/2	x 1/2 – 1 DN15 – DN25	2.875 73.0	x 0.840 – 1.315 21.3 – 33.7	1/2 M12	7/8 22	135 ft-lbs 183 N•m
	x 1 1/4 – 1 1/2 DN32 – DN40		x 1.660 – 1.900 42.4 – 48.3	5/8 M16	1 1/16 27	235 ft-lbs 319 N•m
3 DN80	x 3/4 DN20	3.500 88.9	x 1.050 26.9	1/2 M12	7/8 22	135 ft-lbs 183 N•m
	x 1 – 1 1/2 DN25 – DN40		x 1.315 – 1.900 33.7 – 48.3	5/8 M16	1 1/16 27	235 ft-lbs 319 N•m
4 DN100	x 3/4 – 1 DN20 – DN25	4.500 114.3	x 1.050 – 1.315 26.9 – 33.7	1/2 M12	7/8 22	135 ft-lbs 183 N•m
	x 1 1/2 – 2 DN40 – DN50		x 1.900 – 2.375 48.3 – 60.3	5/8 M16	1 1/16 27	235 ft-lbs 319 N•m
6 DN150	x 1 – 2 DN25 – DN50	6.625 219.1	x 1.315 – 2.375 33.7 – 60.3	3/4 M20	1 1/4 32	425 ft-lbs 576 N•m
	DN65		x 3.000 76.1	3/4 M20	1 1/4 32	425 ft-lbs 576 N•m

\* Maximum allowable bolt torque values have been derived from actual test data.

**Style 75** - Flexible Coupling

**Style 77** - Flexible Coupling (24-inch/DN600 and Smaller Sizes - Two Housings)

**Style L77** - Flexible Coupling (12-inch/DN300 and Smaller Sizes)

**Style 77A** - Aluminum Flexible Coupling

**Style 77S** - Stainless Steel Flexible Coupling (8 – 14-inch/DN200 – DN350 Sizes)

**Style 77DX** - Duplex Stainless Steel Flexible Coupling

**Style 475** - Lightweight Stainless Steel Flexible Coupling

**Style 475DX** - Duplex Stainless Steel Flexible Coupling

## **WARNING**



- Read and understand all instructions before attempting to install any Victaulic products.
- Always verify that the piping system has been completely depressurized and drained immediately prior to installation, removal, adjustment, or maintenance of any Victaulic products.
- Confirm that any equipment, branch lines, or sections of piping that may have been isolated for/during testing or due to valve closures/positioning are identified, depressurized, and drained immediately prior to installation, removal, adjustment, or maintenance of any Victaulic products.
- These installation instructions are intended for an experienced, trained installer. The installer shall understand the use of this product and why it was specified for the particular application.
- The installer shall understand common industry safety standards and potential consequences of improper product installation.
- Wear safety glasses, hardhat, and foot protection.

Failure to follow these instructions could result in death or serious personal injury and property damage.

## **NOTICE**

- The following installation steps feature photos of a Style 77 Coupling; however, the same steps apply to installation of Style 75, L77, 77A, 77S, 77DX, 475, and 475DX Couplings in the size ranges listed above.

For Style 475/475DX Couplings Only:

- Style 475/475DX Couplings have a tongue-and-recess feature at the bolt pads. The housings' tongue-and-recess features shall be mated properly (tongue in recess).

For Couplings Supplied with Stainless Steel Bolts and Nuts:

- Apply an anti-seize compound to the bolt threads before installing the hardware.

1. Follow all instructions in the “Preparatory Steps” section on pages 148 – 149.

## **CAUTION**

- Verify that the gasket does not become rolled or pinched while installing the housings.

Failure to follow this instruction may cause gasket damage, resulting in joint leakage and property damage.



**2. INSTALL HOUSINGS:** Install the housings over the gasket. Verify that the housings' keys engage the grooves completely on both mating components. Refer to the “NOTICE” above for Style 475/475DX Couplings.



**3. INSTALL BOLTS/NUTS:** Install the bolts, and thread a nut finger-tight onto each bolt.

For couplings supplied with stainless steel hardware, verify that an anti-seize compound is applied to the bolt threads.

For  $\frac{3}{4}$  – 4-inch/DN25 – DN100 Style 77S Couplings and for  $\frac{3}{4}$  – 6-inch/DN25 – DN150 Style 77DX Couplings with bronze nuts only: A flat washer shall be installed under each nut.

**NOTE:** Verify that the oval neck of each bolt seats properly in the bolt hole.

#### IMPORTANT INFORMATION FOR USE OF STYLE 75, 77, L77, 77A, 77S, 77DX, 475, AND 475DX COUPLINGS WITH END CAPS:

### **! WARNING**

- Always read and follow the “Victaulic End Cap Installation Safety Instructions” section in this handbook.

Failure to follow the “Victaulic End Cap Installation Safety Instructions” section could result in death or serious personal injury and property damage.

- Always confirm that any equipment, branch lines, or sections of piping that may have been isolated for/during testing or due to valve closures/positioning are identified, depressurized, and drained immediately prior to working with an end cap.

### **! WARNING**

- For Style 475/475DX Couplings, the housings’ tongue-and-recess features shall be mated properly (tongue in recess).
- Nuts shall be tightened evenly by alternating sides, maintaining nearly uniform bolt pad gaps, until metal-to-metal contact occurs at the bolt pads, as indicated in steps 4 and 5.
- Keep hands away from coupling openings during tightening.

Failure to tighten nuts as instructed will cause increased loading of the hardware, resulting in the following conditions:

- Excessive bolt torque required to assemble the joint (incomplete assembly)
- Damage to the assembled joint (damaged or broken bolt pads or fractures to housings)
- Bolt damage or fracture
- Joint leakage and property damage
- A negative impact on system integrity
- Personal injury or death

DO NOT continue to tighten the nuts after the visual, metal-to-metal bolt pad inspection requirement is achieved.

- Failure to follow this instruction could result in the conditions listed above.

### **NOTICE**

- It is important to tighten the nuts evenly by alternating sides to prevent gasket pinching.
- An impact tool or standard socket wrench with a deep-well socket can be used to bring the bolt pads into metal-to-metal contact.
- Refer to the “Impact Tool Usage Guidelines” and “Impact Tool Selection” sections in this handbook, along with the applicable “Helpful Information” table on pages 172 – 174.



**4. TIGHTEN NUTS:** Using an impact tool or a standard socket wrench with a deep-well socket, tighten the nuts evenly by alternating sides, maintaining nearly uniform bolt pad gaps, until metal-to-metal contact occurs at the bolt pads. Verify that the oval neck of each bolt seats properly in the bolt holes. **DO NOT** continue to tighten the nuts after the visual, metal-to-metal bolt pad inspection requirement is achieved..

**If you suspect that any hardware has been over-tightened (as indicated by a bend in the bolt, bulging of the nut at the bolt pad interface, or damage to the bolt pad, etc.), the entire coupling assembly shall be replaced immediately.** Refer to the “Impact Tool Usage Guidelines” and “Impact Tool Selection” sections in this handbook, along with the applicable “Helpful Information” table on the following pages.

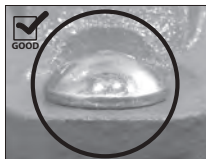

**OVAL NECK OF BOLT SEATED PROPERLY**



**OVAL NECK OF BOLT NOT SEATED PROPERLY**

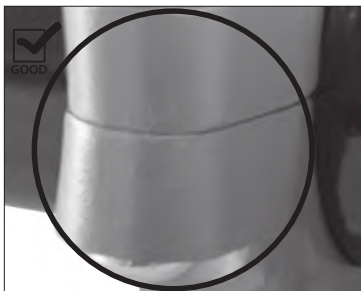

**5. Visually inspect each bolt pad location at every joint to verify that metal-to-metal contact is achieved across the entire bolt pad section.**

### **! WARNING**

- Visual inspection of each joint is required.
- Improperly assembled joints shall be corrected before the system is filled, tested, or placed into service.
- Any components that exhibit physical damage due to improper assembly shall be replaced before the system is filled, tested, or placed into service.

Failure to follow these instructions could cause joint failure, resulting in death or serious personal injury and property damage.

## Style 75, 77, L77, and 77A Helpful Information

Nominal Pipe Size inches/ DN	Actual Pipe Outside Diameter inches mm	Style 75			Style 77/L77†/77A		
		Nut Size inches/ Metric	Deep-Well Socket Size inches/ mm	Maximum Allowable Bolt Torque*	Nut Size inches/ Metric	Deep-Well Socket Size inches/ mm	Maximum Allowable Bolt Torque*
¾ DN20	1.050 26.9	—	—	—	¾ M10	1½ 17	55 ft-lbs 75 N•m
1 DN25	1.315 33.7†	¾ M10	1½ 17	55 ft-lbs 75 N•m	¾ M10	1½ 17	55 ft-lbs 75 N•m
1¼ DN32	1.660 42.4†	¾ M10	1½ 17	55 ft-lbs 75 N•m	½ M12	7⁄8 22	135 ft-lbs 183 N•m
1½ DN40	1.900 48.3	¾ M10	1½ 17	55 ft-lbs 75 N•m	½ M12	7⁄8 22	135 ft-lbs 183 N•m
2 DN50	2.375 60.3	¾ M10	1½ 17	55 ft-lbs 75 N•m	½ M12	7⁄8 22	135 ft-lbs 183 N•m
	2.664 57.0	¾ M10	1½ 17	55 ft-lbs 75 N•m	½ M12	7⁄8 22	135 ft-lbs 183 N•m
2½	2.875 73.0	¾ M10	1½ 17	55 ft-lbs 75 N•m	½ M12	7⁄8 22	135 ft-lbs 183 N•m
DN65	3.000 76.1	¾ M10	1½ 17	55 ft-lbs 75 N•m	½ M12	7⁄8 22	135 ft-lbs 183 N•m
3 DN80	3.500 88.9	½ M12	7⁄8 22	135 ft-lbs 183 N•m	½ M12	7⁄8 22	135 ft-lbs 183 N•m
3½ DN90	4.000 101.6	½ M12	7⁄8 22	135 ft-lbs 183 N•m	5⁄8 M16	1 1⁄16 27	235 ft-lbs 319 N•m
	4.250 108.0	½ M12	7⁄8 22	135 ft-lbs 183 N•m	5⁄8 M16	1 1⁄16 27	235 ft-lbs 319 N•m
4 DN100	4.500 114.3	½ M12	7⁄8 22	135 ft-lbs 183 N•m	5⁄8 M16	1 1⁄16 27	235 ft-lbs 319 N•m
	5.000 127.0	5⁄8 M16	1 1⁄16 27	235 ft-lbs 319 N•m	—	—	—
	5.250 133.0	5⁄8 M16	1 1⁄16 27	235 ft-lbs 319 N•m	¾ M20	1 ¼ 32	425 ft-lbs 576 N•m
DN125	5.500 139.7	5⁄8 M16	1 1⁄16 27	235 ft-lbs 319 N•m	¾ M20	1 ¼ 32	425 ft-lbs 576 N•m
5	5.563 141.3	5⁄8 M16	1 1⁄16 27	235 ft-lbs 319 N•m	¾ M20	1 ¼ 32	425 ft-lbs 576 N•m
	6.000 152.4	5⁄8 M16	1 1⁄16 27	235 ft-lbs 319 N•m	—	—	—
	6.250 159.0	5⁄8 M16	1 1⁄16 27	235 ft-lbs 319 N•m	¾ M20	1 ¼ 32	425 ft-lbs 576 N•m
	6.500 165.1	5⁄8 M16	1 1⁄16 27	235 ft-lbs 319 N•m	¾ M20	1 ¼ 32	425 ft-lbs 576 N•m
6 DN150	6.625 168.3	5⁄8 M16	1 1⁄16 27	235 ft-lbs 319 N•m	¾ M20	1 ¼ 32	425 ft-lbs 576 N•m
#	8.515 216.3	¾ M20	1 ¼ 32	425 ft-lbs 576 N•m	7⁄8 M22	1 7⁄16 36	675 ft-lbs 915 N•m
8 DN200	8.625 219.1	¾ M20	1 ¼ 32	425 ft-lbs 576 N•m	7⁄8 M22	1 7⁄16 36	675 ft-lbs 915 N•m

‡ The Style L77 may not be available in all sizes listed.

† Style 75 and 77/77A housings are marked 33.4 mm and 42.2 mm, respectively.

# Applies to JIS metric pipe sizes 200A, 250A, and 300A, respectively (JIS Specification G 3452; G 3454).

\* Maximum allowable bolt torque values have been derived from actual test data.



## Style 75, 77, L77, and 77A Helpful Information (Continued)

Nominal Pipe Size inches/ DN	Actual Pipe Outside Diameter inches/ mm	Style 75			Style 77/L77‡/77A		
		Nut Size inches/ Metric	Deep-Well Socket Size inches/ mm	Maximum Allowable Bolt Torque*	Nut Size inches/ Metric	Deep-Well Socket Size inches/ mm	Maximum Allowable Bolt Torque*
#	10.528 267.4	—	—	—	1 M24	1 5/8 41	875 ft-lbs 1186 N•m
10 DN250	10.750 273.0	—	—	—	1 M24	1 5/8 41	875 ft-lbs 1186 N•m
#	12.539 318.5	—	—	—	1 M24	1 5/8 41	875 ft-lbs 1186 N•m
12 DN300	12.750 323.9	—	—	—	1 M24	1 5/8 41	875 ft-lbs 1186 N•m
14 DN350	14.000 355.6	—	—	—	1 M24	1 5/8 41	875 ft-lbs 1186 N•m
	14.842 377.0	—	—	—	1 M24	1 5/8 41	875 ft-lbs 1186 N•m
16 DN400	16.000 406.4	—	—	—	1 M24	1 5/8 41	875 ft-lbs 1186 N•m
	16.772 426.0	—	—	—	1 M24	1 5/8 41	875 ft-lbs 1186 N•m
18 DN450	18.000 457	—	—	—	1 1/8 M27	1 13/16 46	875 ft-lbs 1186 N•m
	18.898 480.0	—	—	—	1 1/8 M27	1 13/16 46	875 ft-lbs 1186 N•m
20 DN500	20.000 508.0	—	—	—	1 1/8 M27	1 13/16 46	875 ft-lbs 1186 N•m
	20.866 530.0	—	—	—	1 1/8 M27	1 13/16 46	875 ft-lbs 1186 N•m
	22.000 559.0	—	—	—	1 1/8 M27	1 13/16 46	875 ft-lbs 1186 N•m
	22.835 580.0	—	—	—	1 1/8 M27	1 13/16 46	875 ft-lbs 1186 N•m
24 DN600	24.000 609.6	—	—	—	1 1/8 M27	1 13/16 46	875 ft-lbs 1186 N•m
	24.803 630.0	—	—	—	1 1/8 M27	1 13/16 46	875 ft-lbs 1186 N•m

‡ The Style L77 may not be available in all sizes listed.

# Applies to JIS metric pipe sizes 200A, 250A, and 300A, respectively (JIS Specification G 3452; G 3454).

\* Maximum allowable bolt torque values have been derived from actual test data.

## Style 77S Helpful Information

Nominal Pipe Size inches/DN	Actual Pipe Outside Diameter inches mm	Style 77S		
		Nut Size inches/ Metric	Deep-Well Socket Size inches/ mm	Maximum Allowable Bolt Torque*
8 DN200	8.625 219.1	$\frac{7}{8}$ M22	$1\frac{7}{16}$ 36	675 ft-lbs 915 N•m
10 – 14 DN250 – DN350	10.750 – 14.000 273.0 – 355.6	1 M24	$1\frac{5}{8}$ 41	875 ft-lbs 1186 N•m

## Style 77DX, 475, and 475DX Helpful Information

Nominal Pipe Size inches/ DN	Actual Pipe Outside Diameter inches mm	Style 77DX			Style 475/475DX‡		
		Nut Size inches/ Metric	Deep-Well Socket Size inches/ mm	Maximum Allowable Bolt Torque*	Nut Size inches/ Metric	Deep-Well Socket Size inches/ mm	Maximum Allowable Bolt Torque*
$\frac{3}{4}$ DN20	1.050 26.9	$\frac{3}{8}$ M10	$1\frac{1}{16}$ 17	55 ft-lbs 75 N•m	—	—	—
1 DN25	1.315 33.7	$\frac{3}{8}$ M10	$1\frac{1}{16}$ 17	55 ft-lbs 75 N•m	$\frac{3}{8}$ M10	$1\frac{1}{16}$ 17	55 ft-lbs 75 N•m
$1\frac{1}{4}$ DN32	1.660 42.4	$\frac{3}{8}$ M10	$1\frac{1}{16}$ 17	55 ft-lbs 75 N•m	$\frac{3}{8}$ M10	$1\frac{1}{16}$ 17	55 ft-lbs 75 N•m
$1\frac{1}{2}$ DN40	1.900 48.3	$\frac{3}{8}$ M10	$1\frac{1}{16}$ 17	55 ft-lbs 75 N•m	$\frac{3}{8}$ M10	$1\frac{1}{16}$ 17	55 ft-lbs 75 N•m
2 DN50	2.375 60.3	$\frac{3}{8}$ M10	$1\frac{1}{16}$ 17	55 ft-lbs 75 N•m	$\frac{3}{8}$ M10	$1\frac{1}{16}$ 17	55 ft-lbs 75 N•m
$2\frac{1}{2}$ DN65	2.875 73.0	$\frac{3}{8}$ M10	$1\frac{1}{16}$ 17	55 ft-lbs 75 N•m	$\frac{3}{8}$ M10	$1\frac{1}{16}$ 17	55 ft-lbs 75 N•m
3 DN80	3.000 76.1	—	—	—	$\frac{3}{8}$ M10	$1\frac{1}{16}$ 17	55 ft-lbs 75 N•m
4 DN100	3.500 88.9	$\frac{1}{2}$ M12	$\frac{7}{8}$ 22	135 ft-lbs 183 N•m	$\frac{1}{2}$ M12	$\frac{7}{8}$ 22	135 ft-lbs 183 N•m
5 DN125	4.500 114.3	$\frac{5}{8}$ M16	$1\frac{1}{16}$ 27	235 ft-lbs 319 N•m	$\frac{1}{2}$ M12	$\frac{7}{8}$ 22	135 ft-lbs 183 N•m
6 DN150	5.500 139.7	—	—	—	$\frac{1}{2}$ M12	$\frac{7}{8}$ 22	135 ft-lbs 183 N•m
	6.500 165.1	—	—	—	$\frac{5}{8}$ M16	$1\frac{1}{16}$ 27	235 ft-lbs 319 N•m
	6.625 168.3	$\frac{3}{4}$ M20	$1\frac{1}{4}$ 32	425 ft-lbs 576 N•m	—	—	—

‡ The Style 475DX may not be available in all sizes listed.

\* Maximum allowable bolt torque values have been derived from actual test data.

**! WARNING**



- Read and understand all instructions before attempting to install any Victaulic products.
- Always verify that the piping system has been completely depressurized and drained immediately prior to installation, removal, adjustment, or maintenance of any Victaulic products.
- Confirm that any equipment, branch lines, or sections of piping that may have been isolated for/during testing or due to valve closures/positioning are identified, depressurized, and drained immediately prior to installation, removal, adjustment, or maintenance of any Victaulic products.
- These installation instructions are intended for an experienced, trained installer. The installer shall understand the use of this product and why it was specified for the particular application.
- The installer shall understand common industry safety standards and potential consequences of improper product installation.
- Wear safety glasses, hardhat, and foot protection.

Failure to follow these instructions could result in death or serious personal injury and property damage.

**NOTICE**

- When Style 78/78A Snap-Joint Couplings are used in concrete pumping, the working pressure shall include shock load. This coupling shall be used within all design parameters.
- Style 78/78A Snap-Joint Couplings and pipe used in concrete pumping shall be free from concrete and foreign material in the pipe grooves and the keys and gasket cavity of the couplings.
- Style 78/78A Snap-Joint Couplings are not designed for eccentric loading. These couplings are not recommended for use at the end of concrete pumping booms or on vertical risers above 30 feet/9.1 m. Sound anchoring and lashing practices shall always be observed.

1. Follow all instructions in the “Preparatory Steps” section on pages 148 – 149.



**2. INSTALL HOUSINGS:** Install one housing of the hinged assembly over the gasket. Verify that the housing’s keys engage the grooves completely on both mating components. Swing the other housing of the hinged assembly into position. Squeeze the housings together to further center the gasket and to engage the grooves completely on both mating components.



**3. POSITION LOCKING HANDLE:** Lift the locking handle to position the nose in the cradle tab of the opposite housing, as shown to the left.

## ! WARNING

- **DO NOT** use hammers/heavy instruments to close the locking handle. Use of hammers/heavy instruments to close the locking handle can crack, distort, or misalign components.
- Use caution to prevent fingers/hands from being pinched while the locking handle is being closed.

Failure to follow these instructions could result in death or serious personal injury and property damage.



**4. CLOSE LOCKING HANDLE:** Close the locking handle by pushing down firmly until the handle assembly contacts the coupling housing, as shown to the left. The handle assembly shall contact the coupling housing to ensure a properly installed joint.

### Assembly Clearance Requirements for Style 78 Snap-Joint Couplings

Nominal Pipe Size inches/DN	Actual Pipe Outside Diameter inches/mm	Partially Assembled inches/mm	Fully Extended inches/mm
1 DN25	1.315 33.7	3.38 85.9	4.50 114.3
1 ¼ DN32	1.660 42.4	3.80 96.5	4.88 124.0
1 ½ DN40	1.900 48.3	5.50 139.7	7.63 193.8
2 DN50	2.375 60.3	6.25 158.8	7.75 196.9
2 ½ DN65	2.875 73.0	7.16 181.9	10.72 272.3
3 DN80	3.500 88.9	7.88 200.2	10.25 260.4
4 DN100	4.500 114.3	10.63 270.0	12.88 327.2
5 DN125	5.563 141.3	13.66 347.0	16.88 428.8
6 DN150	6.625 168.3	14.88 378.0	18.38 466.9
8 DN200	8.625 219.1	15.38 390.7	18.91 480.3

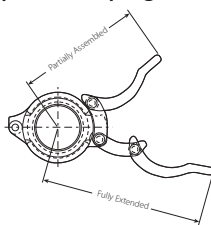

### Assembly Clearance Requirements for Style 78A Snap-Joint Aluminum Couplings

Nominal Pipe Size inches/DN	Actual Pipe Outside Diameter inches/mm	Partially Assembled inches/mm	Fully Extended inches/mm
2 DN50	2.375 60.3	3.22 81.8	4.06 103.1
10 DN250	10.750 273.0	21.00 533.4	23.00 584.2

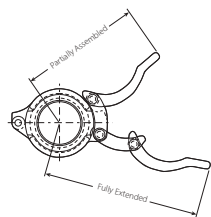

## Disassembly and Reassembly Instructions for Style 78/78A Snap-Joint Couplings

### **WARNING**



- Always verify that the piping system has been completely depressurized and drained immediately prior to installation, removal, adjustment, or maintenance of any Victaulic products.

- Confirm that any equipment, branch lines, or sections of piping that may have been isolated for/during testing or due to valve closures/positioning are identified, depressurized, and drained immediately prior to installation, removal, adjustment, or maintenance of any Victaulic products.

**Failure to follow this instruction could result in death or serious personal injury and property damage.**

1. Verify that the system is depressurized and drained completely before attempting to disassemble any couplings.
2. Slide a screwdriver or similar pry tool underneath the locking handle for leverage.
3. Pull the locking handle away from the coupling housing. Remove the coupling and gasket from the mating component ends. Check the housing hinge and locking handle to verify that they have not become loosened, distorted, bent, or damaged. If there is any doubt about the condition of the coupling or gasket, a new Victaulic-supplied coupling assembly shall be used.
4. Follow all instructions in this section for reassembly of the coupling.

**Style 750** - Reducing Coupling

**Style 875** - Reducing Coupling for Potable Water Applications

## ! WARNING



- Read and understand all instructions before attempting to install any Victaulic products.
- Always verify that the piping system has been completely depressurized and drained immediately prior to installation, removal, adjustment, or maintenance of any Victaulic products.
- Confirm that any equipment, branch lines, or sections of piping that may have been isolated for/during testing or due to valve closures/positioning are identified, depressurized, and drained immediately prior to installation, removal, adjustment, or maintenance of any Victaulic products.
- These installation instructions are intended for an experienced, trained installer. The installer shall understand the use of this product and why it was specified for the particular application.
- The installer shall understand common industry safety standards and potential consequences of improper product installation.
- Wear safety glasses, hardhat, and foot protection.

Failure to follow these instructions could result in death or serious personal injury and property damage.

## NOTICE

- End caps **SHALL NOT** be installed on the smaller end of Style 750 or 875 Reducing Couplings in systems where vacuums may develop.
- The following installation steps feature photos of a Style 750 Reducing Coupling; however, the same steps apply to installation of Style 875 Reducing Couplings.

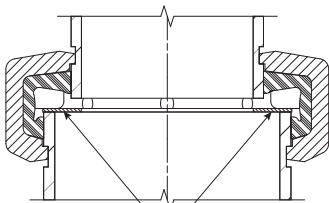

Assembly Washer

- **FOR VERTICAL INSTALLATIONS:** An assembly washer is recommended to prevent smaller pipe from telescoping inside larger pipe in vertical installations (refer to graphic shown to the left). Contact Victaulic for details.

1. Follow steps 1 – 3 in the “Preparatory Steps” section on pages 148 – 149.



2. **INSTALL GASKET:** Install the larger opening of the gasket over the larger mating component end. Verify that no portion of the gasket extends into the groove of the mating component.



**3. JOIN MATING COMPONENTS:** Align the centerlines of the two grooved mating component ends and bring them to within the appropriate pipe-end separation dimension. Insert the smaller mating component end into the gasket. **NOTE:** Verify that no portion of the gasket extends into the groove of either mating component.

### CAUTION

- Verify that the gasket does not become rolled or pinched while installing the housings.

Failure to follow this instruction may cause gasket damage, resulting in joint leakage and property damage.



**4. INSTALL HOUSINGS:** Install the housings over the gasket. Verify that the housings' keys engage the grooves completely on both mating components and that each side of the housing is facing the corresponding mating component side.



**5. INSTALL BOLTS/NUTS:** Install the bolts, and thread a nut finger-tight onto each bolt. **NOTE:** Verify that the oval neck of each bolt seats properly in the bolt hole.

## IMPORTANT INFORMATION FOR USE OF STYLE 750 COUPLINGS WITH END CAPS:

### WARNING

- Always read and follow the "Victaulic End Cap Installation Safety Instructions" section in this handbook.

Failure to follow the "Victaulic End Cap Installation Safety Instructions" section could result in death or serious personal injury and property damage.

- End caps SHALL NOT be installed on the smaller end of Style 750 or 875 Reducing Couplings in systems where vacuums may develop.
- Always confirm that any equipment, branch lines, or sections of piping that may have been isolated for/during testing or due to valve closures/positioning are identified, depressurized, and drained immediately prior to working with an end cap.

## ! WARNING

- Nuts shall be tightened evenly by alternating sides, maintaining nearly uniform bolt pad gaps, until metal-to-metal contact occurs at the bolt pads, as indicated in steps 6 and 7.
- Keep hands away from coupling openings during tightening.

Failure to tighten nuts as instructed will cause increased loading of the hardware, resulting in the following conditions:

- Excessive bolt torque required to assemble the joint (incomplete assembly)
- Damage to the assembled joint (damaged or broken bolt pads or fractures to housings)
- Bolt damage or fracture
- Joint leakage and property damage
- A negative impact on system integrity
- Personal injury or death

DO NOT continue to tighten the nuts after the visual, metal-to-metal bolt pad inspection requirement is achieved.

- Failure to follow this instruction could result in the conditions listed above.

## NOTICE

- It is important to tighten the nuts evenly by alternating sides to prevent gasket pinching.
- An impact tool or standard socket wrench with a deep-well socket can be used to bring the bolt pads into metal-to-metal contact.
- Refer to the “Impact Tool Usage Guidelines” and “Impact Tool Selection” sections in this handbook, along with the “Helpful Information” table on the following page.



**6. TIGHTEN NUTS:** Using an impact tool or a standard socket wrench with a deep-well socket, tighten the nuts evenly by alternating sides, maintaining nearly uniform bolt pad gaps, until metal-to-metal contact occurs at the bolt pads. Verify that the oval neck of each bolt seats properly in the bolt holes. DO NOT continue to tighten the nuts after the visual, metal-to-metal bolt pad inspection requirement is achieved.

If you suspect that any hardware has been over-tightened (as indicated by a bend in the bolt, bulging of the nut at the bolt pad interface, or damage to the bolt pad, etc.), the entire coupling assembly shall be replaced immediately. Refer to the “Impact Tool Usage Guidelines” and “Impact Tool Selection” sections in this handbook, along with the “Helpful Information” table on the following page.

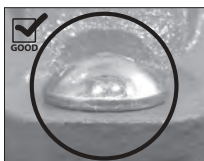

OVAL NECK OF BOLT SEATED PROPERLY



OVAL NECK OF BOLT NOT SEATED PROPERLY

## ! WARNING

- Visual inspection of each joint is required.
- Improperly assembled joints shall be corrected before the system is filled, tested, or placed into service.
- Any components that exhibit physical damage due to improper assembly shall be replaced before the system is filled, tested, or placed into service.

Failure to follow these instructions could cause joint failure, resulting in death or serious personal injury and property damage.



7. Visually inspect each bolt pad location at every joint to verify that metal-to-metal contact is achieved across the entire bolt pad section.

### Helpful Information

Nominal Pipe Size inches/DN	Actual Pipe Outside Diameter inches/mm	Nut Size inches/ Metric	Deep- Well Socket Size inches/ mm	Maximum Allowable Bolt Torque*
2 DN50 x 1 – 1½ DN25 – DN40	2.375 x 1.315 – 1.900 60.3 x 33.7 – 48.3	¾ M10	1⅛ 17	55 ft-lbs 75 N•m
2½ x 2 DN50	2.875 x 2.375 73.0 x 60.3	¾ M10	1⅛ 17	55 ft-lbs 75 N•m
DN65 x 2 DN50	3.000 x 2.375 76.1 x 60.3	½ M12	⅞ 22	135 ft-lbs 183 N•m
3 DN80 x 2 DN50	3.500 x 2.375 88.9 x 60.3	½ M12	⅞ 22	135 ft-lbs 183 N•m
		2½	⅞ 22	135 ft-lbs 183 N•m
		DN65	⅞ 22	135 ft-lbs 183 N•m
4 DN100 x 2 – 3 DN50 – DN80	4.500 x 2.375 – 3.500 114.3 x 60.3 – 88.9	⅝ M16	1⅛ 27	235 ft-lbs 319 N•m
5 x 4 DN100	5.563 x 4.500 141.3 x 114.3	¾ M20	1¼ 32	425 ft-lbs 576 N•m
165.1 x 4 DN100	6.500 x 4.500 165.1 x 114.3	¾ M20	1¼ 32	425 ft-lbs 576 N•m
6 DN150 x 4 DN100	6.625 x 4.500 168.3 x 114.3	¾ M20	1¼ 32	425 ft-lbs 576 N•m
		5	¾ M20	1¼ 32
8 DN200 x 165.1	8.625 x 6.500 219.1 x 165.1	⅞ M22	1⅛ 36	675 ft-lbs 915 N•m
		6 DN150	⅞ M22	1⅛ 36
10 DN250 x 8 DN200	10.750 x 8.625 273.0 x 219.1	1 M24	1⅝ 41	875 ft-lbs 1186 N•m

\* Maximum allowable bolt torque values have been derived from actual test data.

**! WARNING**



- Read and understand all instructions before attempting to install any Victaulic products.
- Always verify that the piping system has been completely depressurized and drained immediately prior to installation, removal, adjustment, or maintenance of any Victaulic products.
- Confirm that any equipment, branch lines, or sections of piping that may have been isolated for/during testing or due to valve closures/positioning are identified, depressurized, and drained immediately prior to installation, removal, adjustment, or maintenance of any Victaulic products.
- These installation instructions are intended for an experienced, trained installer. The installer shall understand the use of this product and why it was specified for the particular application.
- The installer shall understand common industry safety standards and potential consequences of improper product installation.
- Wear safety glasses, hardhat, and foot protection.

Failure to follow these instructions could result in death or serious personal injury and property damage.

1. Follow steps 1 – 3 in the “Preparatory Steps” section on pages 148 – 149.



**2. INSTALL GASKET:** Install the larger opening of the gasket (marked NPS) over the larger mating component end (NPS side). **NOTE:** Verify that the gasket does not overhang the mating component end.



**3. JOIN MATING COMPONENTS:** Align the centerlines of the NPS and JIS grooved mating component ends and bring them to within the appropriate pipe-end separation dimension. Slide the gasket into position and center it between the groove of each mating component. **NOTE:** Verify that no portion of the gasket extends into the groove of either mating component and that the NPS side of the gasket is facing the NPS mating component.

**! CAUTION**

- Verify that the gasket does not become rolled or pinched while installing the housings.

Failure to follow this instruction may cause gasket damage, resulting in joint leakage and property damage.

## NOTICE

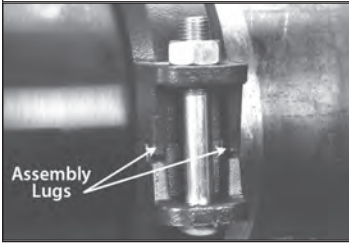

- Victaulic Style 707-IJ Transition Couplings are designed with assembly lugs to ensure proper assembly of housings (NPS to NPS and JIS to JIS). These assembly lugs shall be on opposite sides for proper assembly.

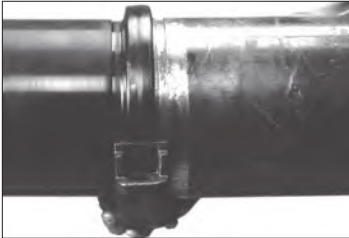

4. **INSTALL HOUSINGS:** Install the housings over the gasket with the assembly lugs on opposite sides. Verify that the larger openings of the housings (marked NPS) face the larger mating component (NPS side) and that the housings' keys engage the grooves completely on both mating components.

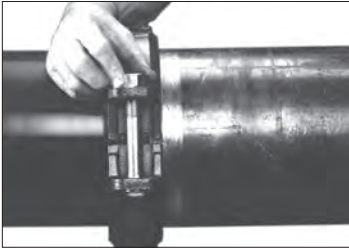

5. **INSTALL BOLTS/NUTS:** Install the bolts, and thread a nut finger-tight onto each bolt. **NOTE:** Verify that the oval neck of each bolt seats properly in the bolt hole.

### IMPORTANT INFORMATION FOR USE OF STYLE 707-IJ COUPLINGS WITH END CAPS:

#### WARNING

- Always read and follow the “Victaulic End Cap Installation Safety Instructions” section in this handbook.  
Failure to follow the “Victaulic End Cap Installation Safety Instructions” section could result in death or serious personal injury and property damage.
- Always confirm that any equipment, branch lines, or sections of piping that may have been isolated for/during testing or due to valve closures/positioning are identified, depressurized, and drained immediately prior to working with an end cap.

## ! WARNING

- The housings' assembly lugs shall be on opposite sides for proper assembly.
- Nuts shall be tightened evenly by alternating sides, maintaining nearly uniform bolt pad gaps, until metal-to-metal contact occurs at the bolt pads, as indicated in steps 6 and 7.
- Keep hands away from coupling openings during tightening.

Failure to tighten nuts as instructed will cause increased loading of the hardware, resulting in the following conditions:

- Excessive bolt torque required to assemble the joint (incomplete assembly)
- Damage to the assembled joint (damaged or broken bolt pads or fractures to housings)
- Bolt damage or fracture
- Joint leakage and property damage
- A negative impact on system integrity
- Personal injury or death

**DO NOT** continue to tighten the nuts after the visual, metal-to-metal bolt pad inspection requirement is achieved.

- Failure to follow this instruction could result in the conditions listed above.

## NOTICE

- It is important to tighten the nuts evenly by alternating sides to prevent gasket pinching.
- An impact tool or standard socket wrench with a deep-well socket can be used to bring the bolt pads into metal-to-metal contact.
- Refer to the "Impact Tool Usage Guidelines" and "Impact Tool Selection" sections in this handbook, along with the "Helpful Information" table on the following page.

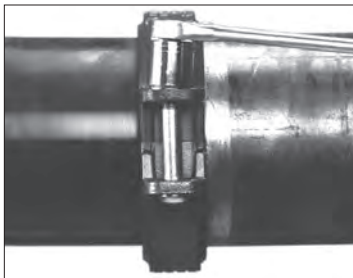

**6. TIGHTEN NUTS:** Using an impact tool or a standard socket wrench with a deep-well socket, tighten the nuts evenly by alternating sides, maintaining nearly uniform bolt pad gaps, until metal-to-metal contact occurs at the bolt pads. Verify that the oval neck of each bolt seats properly in the bolt holes. **DO NOT** continue to tighten the nuts after the visual, metal-to-metal bolt pad inspection requirement is achieved.

If you suspect that any hardware has been over-tightened (as indicated by a bend in the bolt, bulging of the nut at the bolt pad interface, or damage to the bolt pad, etc.), the entire coupling assembly shall be replaced immediately. Refer to the "Impact Tool Usage Guidelines" and "Impact Tool Selection" sections in this handbook, along with the "Helpful Information" table on the following page.

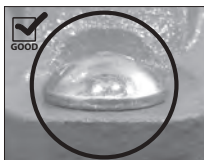

OVAL NECK OF BOLT  
SEATED PROPERLY



OVAL NECK OF BOLT  
NOT SEATED PROPERLY

## ! WARNING

- Visual inspection of each joint is required.
- Improperly assembled joints shall be corrected before the system is filled, tested, or placed into service.
- Any components that exhibit physical damage due to improper assembly shall be replaced before the system is filled, tested, or placed into service.

Failure to follow these instructions could cause joint failure, resulting in death or serious personal injury and property damage.

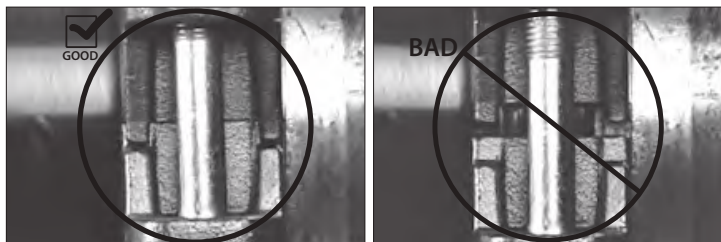

7. Visually inspect each bolt pad location at every joint to verify that metal-to-metal contact is achieved across the entire bolt pad section.

### Helpful Information

Nominal Pipe Size		Actual Pipe Outside Diameter		Nut Size Metric/ inches	Socket Size mm/ inches	Maximum Allowable Bolt Torque*
NPS DN/inches	JIS mm	NPS mm/inches	JIS mm			
DN200 8	200A	219.1 8.625	216.3	M20 ¾	32 1¼	425 ft-lbs 576 N•m
DN250 10	250A	273.0 10.750	267.4	M22 7/8	36 1 7/16	675 ft-lbs 915 N•m
DN300 12	300A	323.9 12.750	318.5	M22 7/8	36 1 7/16	675 ft-lbs 915 N•m

\* Maximum allowable bolt torque values have been derived from actual test data.

# INSTRUCTIONS FOR REASSEMBLY OF COUPLINGS FEATURED IN THIS SECTION

Couplings featured in this section can be reassembled by following the instructions below. **NOTE:** For Style 78/78A Snap-Joint™ Couplings and 791 Vic-Boltless Couplings, refer to the specific reassembly requirements included at the end of their respective installation instructions.

## WARNING



- Always verify that the piping system has been completely depressurized and drained immediately prior to installation, removal, adjustment, or maintenance of any Victaulic products.

- Confirm that any equipment, branch lines, or sections of piping that may have been isolated for/during testing or due to valve closures/positioning are identified, depressurized, and drained immediately prior to installation, removal, adjustment, or maintenance of any Victaulic products.

**Failure to follow this instruction could result in death or serious personal injury and property damage.**

1. Verify that the system is depressurized and drained completely before attempting to disassemble any couplings.
2. Loosen the nuts of the coupling assembly to permit removal of the coupling from the mating component ends.
3. Remove the nuts, bolts, and gasket from the housings. Inspect all components for any damage or wear. If any damage or wear is present, use a new Victaulic-supplied coupling assembly.
4. Check mating component ends and lubricate gasket, as described in the "Preparatory Steps" section on pages 148 – 149 or the applicable product's installation instructions.
5. Reassemble the coupling by following the applicable product's installation instructions.

# **Standard Coupling for EndSeal™ Grooved-End Mating Components**

**Installation Instructions**

**Instructions for Reassembly**

**! WARNING**



- Read and understand all instructions before attempting to install any Victaulic products.
- Always verify that the piping system has been completely depressurized and drained immediately prior to installation, removal, adjustment, or maintenance of any Victaulic products.
- Confirm that any equipment, branch lines, or sections of piping that may have been isolated for/during testing or due to valve closures/positioning are identified, depressurized, and drained immediately prior to installation, removal, adjustment, or maintenance of any Victaulic products.
- These installation instructions are intended for an experienced, trained installer. The installer shall understand the use of this product and why it was specified for the particular application.
- The installer shall understand common industry safety standards and potential consequences of improper product installation.
- Wear safety glasses, hardhat, and foot protection.

Failure to follow these instructions could result in death or serious personal injury and property damage.

**! WARNING**

- Style HP-70ES Couplings shall be used **ONLY** with pipe that is prepared to Victaulic EndSeal™ “ES” specifications. **DO NOT** attempt to install Style HP-70ES Couplings on pipe that is prepared to any other groove specification.
- Style HP-70ES Couplings **SHALL NOT** be used for installation of Victaulic Series 700 Butterfly Valves.
- Victaulic EndSeal™ Extra-Strong Fittings shall be used for applications with operating pressures over 1000 psi/69 Bar (for 2 – 6-inch/DN50 – DN150 coupling sizes) and 800 psi/55 Bar (for 8 – 12-inch/DN200 – DN300 coupling sizes).

Failure to follow these instructions could cause joint failure, resulting in death or serious personal injury and property damage.



**1. CHECK MATING COMPONENT ENDS:** The outside surface of the mating components, between the groove and the mating component ends, shall be generally free from indentations, projections, weld seam anomalies, and roll marks to ensure a leak-tight seal. All oil, grease, loose paint, dirt, and cutting particles shall be removed. Always verify that the correct groove profile is being used.

The mating components' outside diameter (“OD”), groove dimensions, and maximum allowable flare diameter shall be within the tolerances listed in this handbook for Victaulic EndSeal™ “ES” groove specifications.

**2. CHECK GASKET:** Check the gasket to verify that it is suitable for the intended service. The color code identifies the material grade. **Refer to page 32 for the “Gasket Color Code Reference” table.** For complete compatibility information, reference Victaulic publications 05.01 and GSG-100, which can be downloaded at [victaulic.com](http://victaulic.com).

## ! CAUTION

- A thin coat of a compatible lubricant shall be applied to the gasket sealing lips and exterior to help prevent the gasket from pinching, rolling, or tearing during installation.
  - DO NOT use excessive lubricant on the gasket sealing lips and exterior.
- Failure to use a compatible lubricant may cause gasket damage, resulting in joint leakage and property damage.

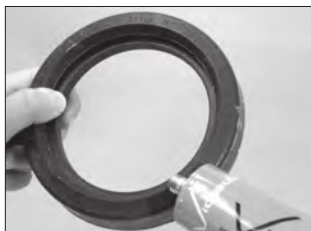

**3. LUBRICATE GASKET:** Apply a thin coat of a compatible lubricant to the gasket sealing lips and exterior. Refer to the “Lubricant Compatibility for Gaskets” table on page 34.



**4. POSITION GASKET:** The Style HP-70ES gasket is molded with a center leg that fits between the mating component ends. Insert the grooved end of a mating component into the gasket until it contacts the center leg of the gasket.



**5. JOIN MATING COMPONENTS:** Align the centerlines of the two grooved mating component ends. Insert the other mating component end into the gasket until it contacts the center leg of the gasket. **NOTE:** Verify that no portion of the gasket extends into the groove of either mating component.

## ! CAUTION

- Verify that the gasket does not become rolled or pinched while installing the housings.
- Failure to follow this instruction could cause gasket damage, resulting in joint leakage.

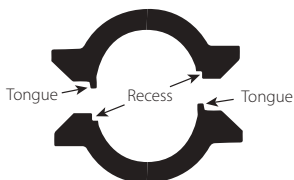
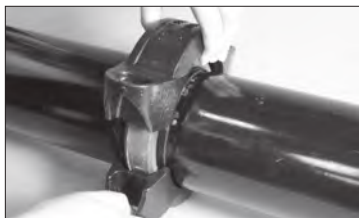

*Exaggerated for clarity*

**6. INSTALL HOUSINGS:** Install the housings over the gasket with the tongue-and-recess features mated properly (tongue in recess). Verify that the housings’ keys engage the grooves completely on both mating components.



**7. INSTALL BOLTS/NUTS:** Install the bolts, and thread a nut finger-tight onto each bolt. **NOTE:** Verify that the oval neck of each bolt seats properly in the bolt hole.

#### IMPORTANT INFORMATION FOR USE OF STYLE HP-70ES COUPLINGS WITH END CAPS:

### **! WARNING**

- Always read and follow the “Victaulic End Cap Installation Safety Instructions” section in this handbook.

Failure to follow the “Victaulic End Cap Installation Safety Instructions” section could result in death or serious personal injury and property damage.

- Victaulic EndSeal™ Extra-Strong End Caps shall be used for applications with operating pressures over 1000 psi/69 Bar (for 2 – 6-inch/DN50 – DN150 coupling sizes) and 800 psi/55 Bar (for 8 – 12-inch/DN200 – DN300 coupling sizes).
- Always confirm that any equipment, branch lines, or sections of piping that may have been isolated for/during testing or due to valve closures/positioning are identified, depressurized, and drained immediately prior to working with an end cap.

### **! WARNING**

- The housings’ tongue-and-recess features shall be mated properly (tongue in recess).
- Nuts shall be tightened evenly by alternating sides, maintaining nearly uniform bolt pad gaps, until metal-to-metal bolt pad contact is achieved, as indicated in steps 8 and 9.
- Keep hands away from coupling openings during tightening.

Failure to tighten nuts as instructed will cause increased loading of the hardware, resulting in the following conditions:

- Excessive bolt torque required to assemble the joint (incomplete assembly)
- Damage to the assembled joint (damaged or broken bolt pads or fractures to housings)
- Bolt damage or fracture
- Joint leakage and property damage
- A negative impact on system integrity
- Personal injury or death

DO NOT continue to tighten the nuts after the visual, metal-to-metal bolt pad inspection requirement is achieved.

- Failure to follow this instruction could result in the conditions listed above.

### **NOTICE**

- It is important to tighten the nuts evenly by alternating sides to prevent gasket pinching.
- An impact tool or standard socket wrench with a deep-well socket can be used to tighten the hardware.
- Refer to the “Impact Tool Usage Guidelines” section in this handbook and the “Helpful Information” table on the following page.



**8. TIGHTEN NUTS:** Using an impact tool or a standard socket wrench with a deep-well socket, tighten the nuts evenly by alternating sides, maintaining nearly uniform bolt pad gaps, until metal-to-metal contact occurs at the bolt pads.

**THE STYLE HP-70ES DOES NOT HAVE A TORQUE REQUIREMENT FOR INSTALLATION.**

Verify that the oval neck of each bolt seats properly in the bolt holes. **DO NOT** continue to tighten the nuts after the visual, metal-to-metal bolt pad inspection requirement is achieved.

If you suspect that any hardware has been over-tightened (as indicated by a bend in the bolt, bulging of the nut at the bolt pad interface, or damage to the bolt pad, etc.), the entire coupling assembly shall be replaced immediately. Refer to the “Impact Tool Usage Guidelines” and “Impact Tool Selection” sections in this handbook, along with the “Helpful Information” table below.

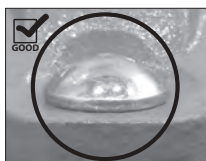

OVAL NECK OF BOLT SEATED PROPERLY



OVAL NECK OF BOLT NOT SEATED PROPERLY

### Helpful Information

Nominal Pipe Size inches/DN	Actual Pipe Outside Diameter inches/mm	Nut Size inches/Metric	Deep-Well Socket Size inches/mm	Maximum Allowable Bolt Torque*
2 DN50	2.375 60.3	5/8 M16	1 1/6 27	235 ft-lbs 319 N•m
2 1/2	2.875 73.0	5/8 M16	1 1/6 27	235 ft-lbs 319 N•m
3 DN80	3.500 88.9	5/8 M16	1 1/6 27	235 ft-lbs 319 N•m
4 DN100	4.500 114.3	3/4 M20	1 1/4 32	425 ft-lbs 576 N•m
6 DN150	6.625 168.3	7/8 M22	1 7/16 36	675 ft-lbs 915 N•m
8 DN200	8.625 219.1	1 M24	1 5/8 41	875 ft-lbs 1186 N•m
10 DN250	10.750 273.0	1 M24	1 5/8 41	875 ft-lbs 1186 N•m
12 DN300	12.750 323.9	1 M24	1 5/8 41	875 ft-lbs 1186 N•m

\* Maximum allowable bolt torque values have been derived from actual test data

Instructions continue on the following page

## ! WARNING

- Visual inspection of each joint is required.
- Improperly assembled joints shall be corrected before the system is tested or placed into service.
- Any components that exhibit physical damage due to improper assembly shall be replaced before the system is tested or placed into service.

Failure to follow these instructions could cause joint failure, resulting in death or serious personal injury and property damage.

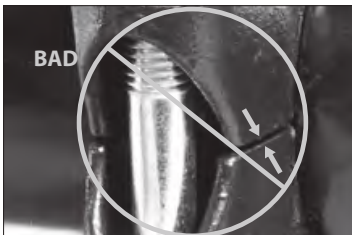
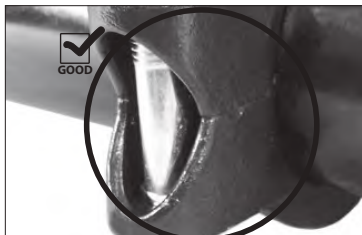

9. Visually inspect each bolt pad location at every joint to verify that metal-to-metal bolt pad contact is achieved.

## INSTRUCTIONS FOR REASSEMBLY

Style HP-70ES Couplings can be reassembled by following the instructions below.

## ! WARNING



- Always verify that the piping system has been completely depressurized and drained immediately prior to installation, removal, adjustment, or maintenance of any Victaulic products.

- Confirm that any equipment, branch lines, or sections of piping that may have been isolated for/during testing or due to valve closures/positioning are identified, depressurized, and drained immediately prior to installation, removal, adjustment, or maintenance of any Victaulic products.

Failure to follow this instruction could result in death or serious personal injury and property damage.

1. Verify that the system is depressurized and drained completely before attempting to disassemble any couplings.
2. Loosen the nuts of the coupling assembly to permit removal of the coupling from the mating component ends.
3. Remove the nuts, bolts, and gasket from the housings. Inspect all components for any damage or wear. If any damage or wear is present, use a new Victaulic-supplied coupling assembly.
4. Check mating component ends, lubricate gasket, and reassemble the coupling by following all instructions in this section.

# **Advanced Groove System *AGS*<sup>™</sup> Couplings for AGS Direct-Grooved Pipe or AGS *Vic-Ring* Applications**

**Installation Instructions**

**Instructions for Reassembly**

- Style W07** - **AGS** Rigid Coupling (24-inch/DN600 and Smaller Sizes)
- Style LW07** - **AGS** Rigid Coupling (14 – 16-inch/DN350 – DN400 Sizes)
- Style W77** - **AGS** Flexible Coupling (24-inch/DN600 and Smaller Sizes)
- Style W89** - **AGS** Rigid Coupling for Direct-Grooved Stainless Steel Pipe or Carbon Steel Pipe Prepared with AGS *Vic-Rings* (24-inch/DN600 and Smaller Sizes)

## ! WARNING



- Read and understand all instructions before attempting to install any Victaulic products.
- Always verify that the piping system has been completely depressurized and drained immediately prior to installation, removal, adjustment, or maintenance of any Victaulic products.
- Confirm that any equipment, branch lines, or sections of piping that may have been isolated for/during testing or due to valve closures/positioning are identified, depressurized, and drained immediately prior to installation, removal, adjustment, or maintenance of any Victaulic products.
- These installation instructions are intended for an experienced, trained installer. The installer shall understand the use of this product and why it was specified for the particular application.
- The installer shall understand common industry safety standards and potential consequences of improper product installation.
- Wear safety glasses, hardhat, and foot protection.

Failure to follow these instructions could result in death or serious personal injury and property damage.

## NOTICE

The following installation steps feature photos of a Style W07/LW07 AGS Rigid Coupling on AGS direct-grooved pipe. Note that the same steps apply to installation of the following:

- Style W77 AGS Flexible Couplings on AGS direct-grooved pipe
- Installation of Style W07 and W77 Couplings on pipe prepared with AGS *Vic-Rings*
- Style W89 AGS Rigid Couplings on AGS direct-grooved stainless steel pipe
- Installation of Style W89 AGS Rigid Couplings on carbon steel pipe prepared with AGS *Vic-Rings*

## ! WARNING

CORRECT - AGS Groove Profile



INCORRECT - OGS Groove Profile



*Pipe and grooves are not shown to scale*

- **DO NOT** attempt to assemble Style W07/LW07, W77, or W89 AGS Couplings on pipe that is direct-grooved with OGS roll sets.

Failure to follow this instruction will cause improper assembly and joint failure, resulting in death or serious personal injury and property damage.

**STYLE W07/LW07, W77, and W89 COUPLINGS HAVE A TORQUE REQUIREMENT. REFER TO THE INSTRUCTIONS ON THE FOLLOWING PAGES OR THE MARKINGS ON THE HOUSINGS FOR THE TORQUE REQUIREMENT.**



**1. PREPARE PIPE:** Prepare the pipe by following the appropriate “Pipe End Inspection and Preparation” section on pages 26 – 27 in this handbook. **Support both pipe lengths securely. Pipe support shall be maintained throughout the entire installation procedure.**

**! CAUTION**

- **A thin coat of a compatible lubricant shall be applied to the gasket sealing lips, gasket exterior, and the interior surface of each coupling housing to help prevent the gasket from pinching, rolling, or tearing during installation.**

**Failure to use a compatible lubricant may cause gasket damage, resulting in joint leakage and property damage.**

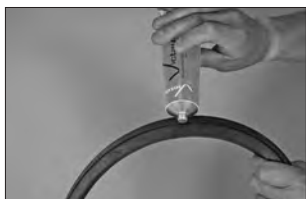

**2a. CHECK GASKET:** Check the gasket to verify that it is suitable for the intended service. The color code identifies the material grade. **For complete compatibility information, reference Victaulic publications 05.01 and GSG-100, which can be downloaded at victaulic.com.**



**2b. LUBRICATE GASKET AND HOUSINGS:** Apply a thin coat of a compatible lubricant, Victaulic Lubricant or silicone grease, to the gasket sealing lips, gasket exterior, and the interior surface of both coupling housings (silicone spray is not a compatible lubricant).



**3. POSITION GASKET:** Position the gasket over the prepared pipe end. Verify that no portion of the gasket overhangs the prepared pipe end.



**4. JOIN PREPARED PIPE ENDS:** Align the centerlines of the two prepared pipe ends and bring them to within the appropriate pipe-end separation dimension. Slide the gasket into position and center it between the groove in each prepared pipe end. Verify that the gasket does not extend into the groove of either prepared pipe end at any point throughout the installation. **The gasket shall fit snug to the prepared pipe ends. No gaps/sags shall be present between the gasket sealing lips and outside diameter of the prepared pipe ends.**

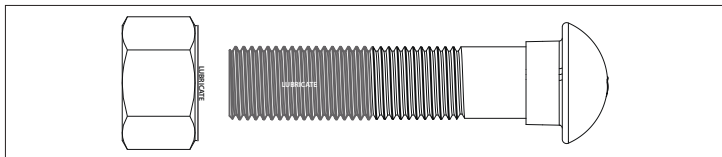

**5. LUBRICATE BOLT THREADS:** At the time of hardware installation, apply a thin coat of Victaulic Lubricant or equivalent bolt thread lubricant to the bolt threads, as indicated above. **NOTE:** If stainless steel hardware is special ordered, apply an anti-seize compound to the bolt threads in the same manner indicated above.

## ! CAUTION

- Verify that the gasket does not become rolled or pinched while installing the housings.

Failure to follow this instruction could cause damage to the gasket, resulting in joint leakage.



**6a. INSTALL HOUSINGS:** Install the housings over the gasket. Verify that the housings' keys completely engage the groove in each prepared pipe end. Maintain support of the housings while preparing to install the lubricated bolts and nuts.

**6b. INSTALL BOLTS/NUTS:** Install the lubricated bolts, and thread a nut onto each bolt.

**NOTE:** Verify that the oval neck of each bolt seats properly in the bolt hole.

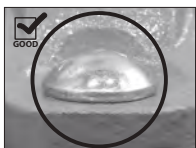

OVAL NECK OF BOLT  
SEATED PROPERLY



OVAL NECK OF BOLT  
NOT SEATED PROPERLY

**7. TIGHTEN NUTS:** Tighten the nuts evenly by alternating sides, maintaining nearly uniform bolt pad gaps during tightening. **Continue to tighten the nuts evenly by alternating sides until metal-to-metal bolt pad contact AND the specified torque value are achieved.** Refer to the applicable "Required Torque" and "Helpful Information" tables on the following page. **NOTE:** It is important to tighten the nuts evenly by alternating sides to prevent gasket pinching. Deep-well sockets are required for proper installation due to the longer bolt lengths associated with these couplings.

**TO PREVENT LUBRICATION FROM DRYING OUT AND CAUSING GASKET PINCHING, ALWAYS BRING THE BOLT PADS INTO METAL-TO-METAL CONTACT IMMEDIATELY AFTER ASSEMBLING THE COUPLING ONTO THE PREPARED PIPE ENDS.**

## ! WARNING

- Nuts shall be tightened evenly by alternating sides, maintaining nearly uniform bolt pad gaps, until both conditions of metal-to-metal bolt pad contact AND the specified torque value are achieved.
- Always bring the bolt pads into metal-to-metal contact immediately after assembling the coupling onto prepared pipe ends.
- Keep hands away from coupling openings during tightening.

Failure to follow instructions for tightening coupling hardware could result in:

- Excessive bolt torque required to assemble the joint (incomplete assembly)
- Bolt damage or fracture
- Joint leakage and property damage
- A negative impact on system integrity
- Personal injury or death

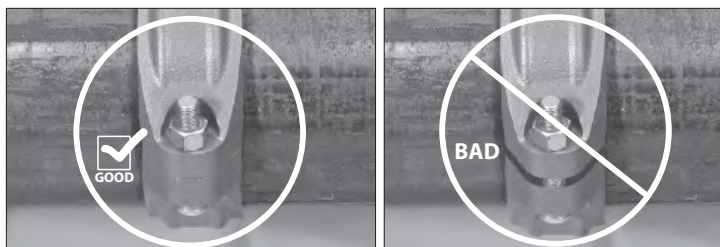

8. Visually inspect each bolt pad location at every joint to verify that metal-to-metal contact is achieved across the entire bolt pad section.

### Style W07/LW07 and W77 Required Torque

Nominal Pipe Size inches/DN	Actual Pipe Outside Diameter inches/mm	Required Torque
14 – 18 DN350 – DN450	14.000 – 18.000 355.6 – 457.2	250 ft-lbs 340 N·m
	14.843 – 24.803 377.0 – 630.0	250 ft-lbs 340 N·m
20 – 24 DN500 – DN600	20.000 – 24.000 508.0 – 609.6	375 ft-lbs 500 N·m

### Style W07/LW07 and W77 Helpful Information

Nominal Pipe Size inches/DN	Actual Pipe Outside Diameter inches/mm	Number of Bolts/Nuts	Nut Size inches/Metric	Socket Size inches/mm
14 – 18 DN350 – DN450	14.000 – 18.000 355.6 – 457.2	2	1 M24	1 5/8 36
	14.843 – 24.803 377.0 – 630.0	2	1 M24	1 5/8 36
20 – 24 DN500 – DN600	20.000 – 24.000 508.0 – 609.6	2	1 1/8 M27	1 13/16 41

### Style W89 Required Torque

Nominal Pipe Size inches/DN	Actual Pipe Outside Diameter inches/mm	Required Torque
14 – 24 DN350 – DN600	14.000 – 24.000 355.6 – 609.6	375 ft-lbs 500 N·m

### Style W89 Helpful Information

Nominal Pipe Size inches/DN	Actual Pipe Outside Diameter inches/mm	Number of Bolts/Nuts	Nut Size inches/Metric	Socket Size inches/mm
14 – 24 DN350 – DN600	14.000 – 24.000 355.6 – 609.6	2	1 1/8 M27	1 13/16 41

# INSTRUCTIONS FOR REASSEMBLY OF COUPLINGS FEATURED IN THIS SECTION

Couplings featured in this section can be reassembled by following the instructions below.

## WARNING



- Always verify that the piping system has been completely depressurized and drained immediately prior to installation, removal, adjustment, or maintenance of any Victaulic products.

- Confirm that any equipment, branch lines, or sections of piping that may have been isolated for/during testing or due to valve closures/positioning are identified, depressurized, and drained immediately prior to installation, removal, adjustment, or maintenance of any Victaulic products.

**Failure to follow this instruction could result in death or serious personal injury and property damage.**

1. Verify that the system is depressurized and drained completely before attempting to disassemble any couplings.
2. Loosen the nuts of the coupling assembly to permit removal of the coupling from the prepared pipe ends.
3. Remove the nuts, bolts, and gasket from the housings. Inspect all components for any damage or wear. If any damage or wear is present, use a new Victaulic-supplied coupling assembly.
4. Check prepared pipe ends, lubricate gasket, and reassemble the coupling by following all steps on pages 194 – 197.

# Flange Adapters for OGS Grooved-End Pipe

## Installation Instructions

# STYLE 441 STAINLESS STEEL VIC-FLANGE ADAPTER NOTES

---

- The Style 441 does not create a rigid connection with the grooved pipe. Some axial, angular, and rotational flexibility of the connection can be expected.

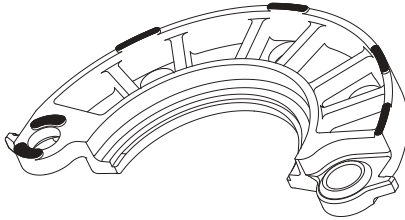

*Exaggerated for clarity*

- The Style 441 is designed for use with ANSI B16.5 Class 150 raised-face mating flanges. When used with a flat-faced flange, the projections on the outside edge and around the mating holes of the Style 441 (highlighted above) shall be ground flush to the housings' surface. Refer to the "Grinding Instructions for Projections on Style 441 and 743 Flange Adapters" section on page 223 for complete instructions.

- The Style 441 **SHALL NOT** be used against rubber-coated surfaces or with wafer- or lug-type valves, with flange washers, or when the Style 441 does not mount flush with the mating flange. For these types of applications, use a No. 445F (flat face) or No. 445R (raised face) Flange Adapter Nipple instead of a Style 441.



No. 445F and No. 445R  
Flange Adapter Nipple

- The Style 441 shall not be used as anchor points for tie rods across non-restrained joints.
- If the Style 441 will be used on more than one outlet of an OGS grooved fitting, verify that there will not be interference between the flanges prior to installation.
- The Style 441 Flange Gasket shall always be assembled with the color-coded lip on the pipe and the other lip facing the mating flange. When installed correctly, the lettering on the Flange Gasket will not be visible when viewing the face of the Style 441 prior to attaching the mating flange.
- **STANDARD FULL-SHANK-DIAMETER ASSEMBLY BOLTS (NOT SUPPLIED) ARE REQUIRED FOR PROPER INSTALLATION OF THE STYLE 441. FULLY-THREADED BOLTS SHALL NOT BE USED.**
- **THE MATING FLANGE SHALL HAVE THE SAME NUMBER OF BOLT HOLES AS THE STYLE 441.**

# STYLE 441 STAINLESS STEEL VIC-FLANGE ADAPTER NOTES (CONTINUED)

- The Style 441 is designed to mate to flanges with a sealing surface roughness conforming to ASME B16.5 requirements, without the use of a Victaulic Flange Washer and mating flange gasket. When mating to flanged components where the sealing surface roughness exceeds ASME B16.5 requirements, Victaulic recommends a No. 445F (flat face) or No. 445R (raised face) Flange Adapter Nipple (shown on the previous page) instead of a Style 441.
- When mating a Style 441 to piping components (valves, strainers, etc.) where the component flange face has an insert, perform a trial fit with the Victaulic Flange Gasket to determine if the insert's bolting falls within the Flange Gasket's inside diameter (ID), as shown to the right. If the insert's bolting does not fall within the Flange Gasket's ID, Victaulic recommends a No. 445F (flat face) or No. 445R (raised face) Flange Adapter Nipple (shown on the previous page) instead of a Style 441.

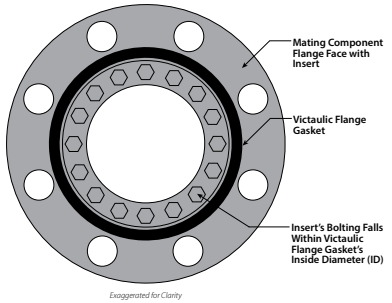

## NOTICE

- **When a Victaulic flange solution is needed to connect components made from dissimilar metals, the system shall be reviewed for the potential of galvanic corrosion. If warranted, a No. 445F (flat face) or No. 445R (raised face) Flange Adapter Nipple (shown on the previous page), a bolt isolation kit, and a phenolic flange washer shall be used instead of a Style 441.**
- **Always reference the bolt isolation kit manufacturer's installation instructions. A qualified engineer or system designer shall ultimately review and approve any solution for galvanic protection of a system.**

**! WARNING**



- Read and understand all instructions before attempting to install any Victaulic products.
  - Always verify that the piping system has been completely depressurized and drained immediately prior to installation, removal, adjustment, or maintenance of any Victaulic products.
  - Confirm that any equipment, branch lines, or sections of piping that may have been isolated for/during testing or due to valve closures/positioning are identified, depressurized, and drained immediately prior to installation, removal, adjustment, or maintenance of any Victaulic products.
  - These installation instructions are intended for an experienced, trained installer. The installer shall understand the use of this product and why it was specified for the particular application.
  - The installer shall understand common industry safety standards and potential consequences of improper product installation.
  - Wear safety glasses, hardhat, and foot protection.
- Failure to follow these instructions could result in death or serious personal injury and property damage.

OGS Roll Groove Profile Shown



*Pipe and groove are not shown to scale*

Style 441 Stainless Steel Vic-Flange Adapters shall be used ONLY with stainless steel pipe that is prepared to Victaulic OGS groove specifications. **DO NOT** attempt to install the Style 441 on pipe that is prepared to any other groove specification.

**! WARNING**

- Style 441 Stainless Steel Vic-Flange Adapters shall be installed only with stainless steel pipe that is prepared to Victaulic OGS groove specifications.
  - Refer to Victaulic publication 17.01 for stainless steel pipe preparation methods, which can be downloaded at [victaulic.com](http://victaulic.com).
  - Victaulic RX grooving rolls shall be used for stainless steel pipe that is designated in Table 1 in Victaulic publication 17.01. Victaulic RX grooving rolls are silver in color and are identified by the "RX" marking on the face.
- Failure to follow these instructions could cause joint failure, resulting in death or serious personal injury and property damage.

**1a. CHECK PIPE END:** The outside surface of the pipe, between the groove and the pipe end, shall be generally free from indentations, projections, weld seam anomalies, and roll marks to ensure a leak-tight seal. All oil, grease, loose paint, dirt, and cutting particles shall be removed. Always verify that the correct groove profile is being used.

The pipe's outside diameter ("OD"), groove dimensions, and maximum allowable flare diameter shall be within the tolerances listed in this handbook for Victaulic OGS groove specifications.

**NOTICE**

- Verify that there is sufficient clearance behind the groove to permit proper assembly of the Style 441.

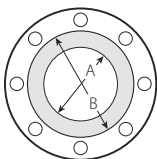

**1b. CHECK MATING FLANGE:** The gray area of the mating flange face (shown to the left) shall be generally free from gouges, undulations, and deformities of any type for proper sealing. Refer to the table below for the required mating flange face sealing surface.

Nominal Pipe Size inches/DN	Actual Pipe Outside Diameter inches/mm	Required Mating Flange Face Sealing Surface inches/mm	
		“A” Maximum	“B” Minimum
2 DN50	2.375 60.3	2.38 61	3.41 87
2½	2.875 73.0	2.88 73	3.91 99
3 DN75	3.500 88.9	3.50 89	4.53 11.5
4 DN100	4.500 114.3	4.50 114	5.53 141
6 DN150	6.625 168.3	6.63 168	7.78 198

**2. CHECK FLANGE GASKET:** Check the Flange Gasket to verify that it is suitable for the intended service. The color code identifies the material grade. Refer to the “Gasket Color Code Reference” table in this handbook. For complete compatibility information, reference Victaulic publications 05.01 and GSG-100, which can be downloaded at [victaulic.com](http://victaulic.com).

### ! CAUTION

- A thin coat of a compatible lubricant shall be applied to the Flange Gasket’s sealing lips and exterior to help prevent the Flange Gasket from pinching, rolling, or tearing during installation.
- DO NOT use excessive lubricant on the Flange Gasket’s sealing lips and exterior. Failure to use a compatible lubricant may cause Flange Gasket damage, resulting in joint leakage and property damage.



**3. LUBRICATE FLANGE GASKET:** Apply a thin coat of a compatible lubricant to the Flange Gasket’s sealing lips and exterior. Refer to the “Lubricant Compatibility for Gaskets” table in this handbook. **NOTE:** This Flange Gasket is designed to provide the sole seal. However, reference shall be made to the “Style 441 Stainless Steel Vic-Flange Notes” section on pages 200 – 201 for special applications.

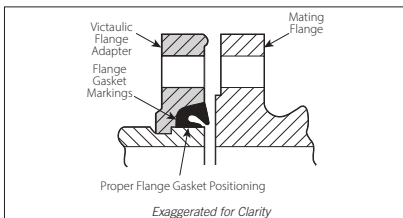

**4. POSITION AND INSTALL FLANGE GASKET:** Verify that the Flange Gasket is positioned properly, then install the Flange Gasket onto the pipe end. The Flange Gasket shall always be assembled with the color-coded lip on the pipe and the other lip facing the mating flange. When installed correctly, the lettering on the Flange Gasket will not be visible when viewing the face of the Style 441. Verify that no portion of the Flange Gasket extends into the groove of the pipe end.

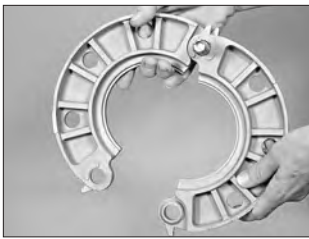

**5. INSERT A STANDARD FULL-SHANK-DIAMETER ASSEMBLY BOLT AT LAP-JOINT BOLT HOLES ON ONE SIDE:** Insert a standard full-shank-diameter assembly bolt through the lap-joint bolt holes on one side to create a hinge, as shown to the left. Refer to the “Helpful Information” table on the following page for the required assembly bolt size and length. **NOTE:** Victaulic does not supply these assembly bolts.

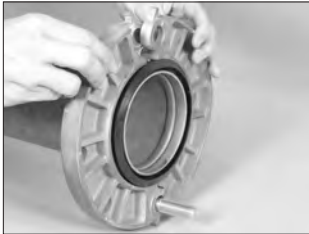

**6. INSTALL STYLE 441:** Install the hinged Style 441 around the grooved pipe end. Verify that the key section of the housings engages with the groove in the pipe end.

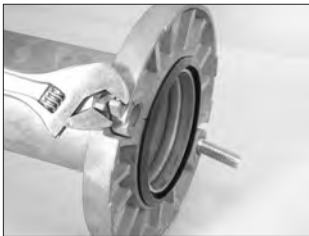

**7a.** Closure lugs are provided for ease of installation. Clamp both lugs with a wrench or pliers to bring the other lap-joint bolt holes into alignment.



**7b.** Insert a standard full-shank-diameter assembly bolt through the lap-joint bolt holes on the opposite side.



**7c.** Verify that the Flange Gasket is still seated properly within the gasket pocket of the Style 441 and that the lettering on the Flange Gasket is not visible when viewing the face of the Style 441.

## NOTICE

- When using stainless steel hardware, an anti-seize lubricant shall be applied to all bolt threads prior to installation of the nuts.



### 8. JOIN STYLE 441 AND MATING FLANGE:

Insert the assembly bolts, installed in steps 5 and 7b, into the mating flange holes. Tighten a nut onto each bolt to prevent the bolts from pulling out.

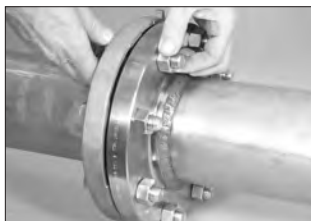

### 9. INSTALL REMAINING STANDARD FULL-SHANK-DIAMETER ASSEMBLY BOLT/NUTS:

Insert a standard full-shank diameter assembly bolt through each remaining hole in the Style 441 and mating flange. Tighten a nut onto each bolt.

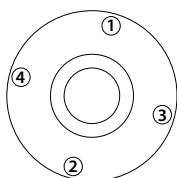

4-Bolt Tightening Pattern

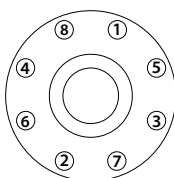

8-Bolt Tightening Pattern



**10. TIGHTEN NUTS:** Tighten all nuts evenly in the applicable pattern shown above until metal-to-metal contact is achieved between the flange faces or the flange-bolt torque requirement for the mating flange is achieved.

## Helpful Information

Nominal Pipe Size inches/DN	Actual Pipe Outside Diameter inches/mm	Standard Full-Shank-Diameter Assembly Bolts/Nuts †		Socket Size inches
		Number of Bolts/Nuts Required	Bolt/Nut Size x Length inches	
2 DN50	2.375 60.3	4	5/8 x 2 3/4	1 1/16
2 1/2	2.875 73.0	4	5/8 x 3	1 1/16
3 DN75	3.500 88.9	4	5/8 x 3	1 1/16
4 DN100	4.500 114.3	8	5/8 x 3	1 1/16
6 DN150	6.625 168.3	8	3/4 x 3 1/2	1 1/4

† Victaulic does not supply the standard full-shank-diameter assembly bolts and nuts. Standard full-shank-diameter assembly bolts are required for proper installation of Style 441 Stainless Steel Vic-Flange Adapters. **Fully-threaded bolts shall not be used.** The assembly bolt sizes listed above are for conventional flange-to-flange connections.

# VICTAULIC FLANGE ADAPTER NOTES FOR 12-INCH/DN300 AND SMALLER SIZES

---

## Style 741 *Vic-Flange* Adapter

## Style 841 *Vic-Flange* Adapter for Potable Water

## Style 743 *Vic-Flange* Adapter

## Style 744 FireLock™ Flange Adapter

- Style 741, 841, and 744 housings incorporate small teeth on the ID of the key section to resist rotation. These teeth shall be ground flush to the housings' surface when the Style 741, 841, and 744 are used with grooved-end Victaulic Series 700 Butterfly Valves, Schedule 5 pipe, and plastic pipe. Refer to the "Grinding Instructions for Teeth on Style 741, 841, and 744 Flange Adapters" section on page 224 for complete instructions.
- The Style 743 is designed for use with ANSI Class 250 and 300 raised-face mating flanges. When used with a flat-faced flange, or when used in a dielectric scenario with a phenolic flange washer, the projections on the outside edge of the Style 743 shall be ground flush to the housings' surface. Refer to the "Grinding Instructions for Projections on Style 441 and 743 Flange Adapters" section on page 223 for complete instructions. **NOTE:** When a Style 743 is used with a flat-faced flange and a Victaulic Flange Washer, DO NOT grind off these projections.
- The Style 741, 841, 743, and 744 shall not be used as anchor points for tie rods across non-restrained joints.
- If the Style 741, 841, 743, or 744 will be used on more than one outlet of an OGS grooved fitting, verify that there will not be interference between the flanges prior to installation.
- DO NOT attempt to install Style 741, 841, 743, or 744 Flange Adapters on FireLock™ fittings.
- The Style 741, 841, 743, and 744 Flange Gasket shall always be assembled with the color-coded lip on the pipe and the other lip facing the mating flange. When installed correctly, the lettering on the Flange Gasket will not be visible when viewing the face of the Style 741, 841, 743, or 744 prior to attaching the mating flange.
- The Style 741 and 841 can be used only on one side of 8-inch/DN200 and smaller Series 700, 705, 707C, 765, and 766 Butterfly Valves that will not interfere with mating components and handle operation.
- Series 461, 700, 705, 707C, 761/861, 765, and 766 Butterfly Valves CANNOT be connected directly to flanged components with Style 743 *Vic-Flange* Adapters. A No. 46 ANSI 300 groove-by-flange adapter is required for this application.
- Style 741 and 841 *Vic-Flange* Adapters CANNOT be used on 10 – 12-inch/ DN250 – DN300 Series 705W Butterfly Valves.
- QuickVic™ Grooved-End Fittings (No. V10, V11, V20) SHALL NOT be used with *Vic-Flange* Adapters. When connecting to flanged components, a No. V15 or V16 Flanged Elbow shall be used.
- Refer to the "Victaulic Flange Washer Notes" section on the following page for details regarding applications that require a Victaulic Flange Washer.
- **STANDARD FULL-SHANK DIAMETER ASSEMBLY BOLTS (NOT SUPPLIED) ARE REQUIRED FOR PROPER INSTALLATION OF THE STYLE 741, 841, 743, AND 744. FULLY-THREADED BOLTS SHALL NOT BE USED.**
- **THE MATING FLANGE SHALL HAVE THE SAME NUMBER OF BOLT HOLES AS THE STYLE 741, 841, 743, OR 744.**

# VICTAULIC FLANGE WASHER NOTES FOR 12-INCH/DN300 AND SMALLER SIZES

Style 741 *Vic-Flange Adapter*

Style 841 *Vic-Flange Adapter for Potable Water*

Style 743 *Vic-Flange Adapter*

Style 744 *FireLock™ Flange Adapter*

Style 741, 841, 743, and 744 Flange Adapters require a smooth, hard surface at the mating flange face for effective sealing. Some applications, for which these Flange Adapters are otherwise well suited, do not provide an adequate mating surface. In such cases, a standard metallic Victaulic Flange Washer shall be inserted between the Victaulic Flange Adapter and the mating flange to provide the necessary sealing surface. Refer to the example to the right. **NOTE:**

**Style 741, 841, and 744 Flange Washers are different dimensions than Style 743 Flange Washers. Direct substitution is prohibited.**

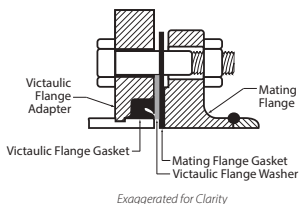

- The Style 741, 841, 743, and 744 are designed to mate to flanges with a sealing surface roughness conforming to ASME B16.5 requirements, without the use of a Victaulic Flange Washer and mating flange gasket. When mating to flanged components where the sealing surface roughness exceeds ASME B16.5 requirements, a standard metallic Victaulic Flange Washer and appropriate mating flange gasket are recommended.
- When mating a Style 741, 841, 743, or 744 to a rubber-faced or partially rubber-faced (smooth or not) piping component, a standard metallic Victaulic Flange Washer shall be placed between the valve and the Victaulic Flange Adapter.

- When mating a Style 741, 841, 743, or 744 to piping components (valves, strainers, etc.) where the component flange face has an insert, perform a trial fit with the Victaulic Flange Gasket to determine if the insert's bolting falls within the Flange Gasket's inside diameter (ID), as shown to the right. If the insert's bolting does not fall within the Flange Gasket's ID, a standard metallic Victaulic Flange Washer and appropriate mating flange gasket are recommended.

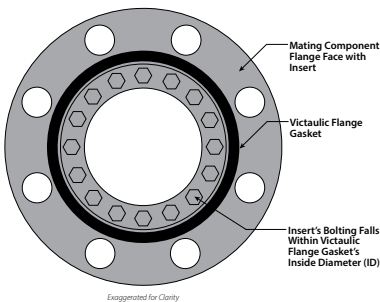

- When mating two Style 741, 841, 743, 744, or 341 Flange Adapters, the Victaulic Flange Washer shall be placed between the two Victaulic Flange Adapters with the hinge points staggered.

## NOTICE

- When a Victaulic flange solution is needed to connect components made from dissimilar metals, the system shall be reviewed for the potential of galvanic corrosion. If warranted, a bolt isolation kit shall be used on the flanged connection, along with a phenolic flange washer (instead of a standard metallic Victaulic Flange Washer).
- Always reference the bolt isolation kit manufacturer's installation instructions. A qualified engineer or system designer shall ultimately review and approve any solution for galvanic protection of a system.

**Style 741** - Vic-Flange Adapter (12-inch/DN300 and Smaller Sizes)

**Style 841** - Vic-Flange Adapter for Potable Water

**Style 743** - Vic-Flange Adapter

**Style 744** - FireLock™ Flange Adapter

## **WARNING**



- Read and understand all instructions before attempting to install any Victaulic products.
- Always verify that the piping system has been completely depressurized and drained immediately prior to installation, removal, adjustment, or maintenance of any Victaulic products.
- Confirm that any equipment, branch lines, or sections of piping that may have been isolated for/during testing or due to valve closures/positioning are identified, depressurized, and drained immediately prior to installation, removal, adjustment, or maintenance of any Victaulic products.
- Wear safety glasses, hardhat, and foot protection.
- FireLock™ products shall be used only in fire protection systems that are designed and installed in accordance with current, applicable National Fire Protection Association (NFPA 13, 13D, 13R, etc.) standards, or equivalent standards, and in accordance with applicable building and fire codes. These standards and codes contain important information regarding protection of systems from freezing temperatures, corrosion, mechanical damage, etc.
- These installation instructions are intended for an experienced, trained installer. The installer shall understand the use of this product and why it was specified for the particular application.
- The installer shall understand common industry safety standards and potential consequences of improper product installation.

Failure to follow these instructions could result in death or serious personal injury and property damage.

OGS Roll Groove Profile Shown



*Pipe and groove are not shown to scale*

The Style 741, 841, 743, and 744 shall be used ONLY with pipe that is prepared to Victaulic OGS groove specifications. **DO NOT** attempt to install these flange adapters on pipe that is prepared to any other groove specification.

**1a. CHECK PIPE END:** The outside surface of the pipe, between the groove and the pipe end, shall be generally free from indentations, projections, weld seam anomalies, and roll marks to ensure a leak-tight seal. All oil, grease, loose paint, dirt, and cutting particles shall be removed. Always verify that the correct groove profile is being used.

The pipe's outside diameter ("OD"), groove dimensions, and maximum allowable flare diameter shall be within the tolerances listed in this handbook for Victaulic OGS groove specifications.

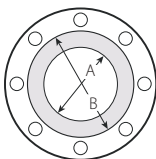

**1b. CHECK MATING FLANGE:** The gray area of the mating flange face (shown to the left) shall be generally free from gouges, undulations, and deformities of any type for proper sealing. Refer to the table below for the required mating flange face sealing surface.

Nominal Pipe Size inches/DN	Actual Pipe Outside Diameter inches/mm	Required Mating Flange Face Sealing Surface inches/mm	
		“A” Maximum	“B” Minimum
2 DN50	2.375 60.3	2.38 60	3.41 87
2½	2.875 73.0	2.88 73	3.91 99
DN65*	3.000 76.1	3.07 78	4.05 103
3 DN80	3.500 88.9	3.50 89	4.53 115
#	4.250 108.0	4.33 110	4.97 126
4 DN100	4.500 114.3	4.50 114	5.53 141
#	5.250 133.0	5.33 135	6.02 153
DN125‡	5.500 139.7	5.59 142	6.73 171
5	5.563 141.3	5.56 141	6.71 170
*	6.250 159.0	6.25 159	7.36 187
*	6.500 165.1	6.50 165	7.68 195
6 DN150	6.625 168.3	6.63 168	7.78 198
8 DN200	8.625 219.1	8.63 219	9.94 252
10 DN250	10.750 273.0	10.75 273	12.31 313
12 DN300	12.750 323.9	12.75 324	14.31 364

\* PN10/PN16 and Chinese Standard Table “E” Flange sizes

# Chinese Standard Table “E” Flange sizes

‡ PN10/PN16 Flange sizes

## NOTICE

- The following installation steps feature photos of a Style 741 *Vic-Flange Adapter*. However, the same installation steps apply to Style 743 and 841 *Vic-Flange Adapters* and Style 744 *FireLock™ Flange Adapters*, except where noted.
- Verify that there is sufficient clearance behind the groove to permit proper assembly of the Style 741, 841, 743, or 744.

**2. CHECK FLANGE GASKET:** Check the Flange Gasket to verify that it is suitable for the intended service. The color code identifies the material grade. Refer to the “Gasket Color Code Reference” table in this handbook. For complete compatibility information, reference Victaulic publications 05.01 and GSG-100, which can be downloaded at [victaulic.com](http://victaulic.com).

## ! CAUTION

- A thin coat of a compatible lubricant shall be applied to the Flange Gasket’s sealing lips and exterior to help prevent the Flange Gasket from pinching, rolling, or tearing during installation.
- **DO NOT** use excessive lubricant on the Flange Gasket’s sealing lips and exterior. Failure to use a compatible lubricant may cause Flange Gasket damage, resulting in joint leakage and property damage.



**3. LUBRICATE FLANGE GASKET:** Apply a thin coat of a compatible lubricant to the Flange Gasket’s sealing lips and exterior. Refer to the “Lubricant Compatibility for Gaskets” table in this handbook. **NOTE:** This Flange Gasket is designed to provide the sole seal. However, reference shall be made to the “Victaulic Flange Washer Notes” section on page 207 for special applications.

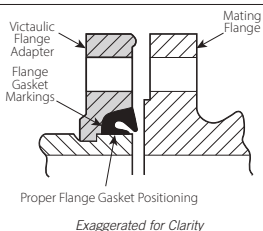

**4. POSITION AND INSTALL FLANGE GASKET:** Verify that the Flange Gasket is positioned properly, then install the Flange Gasket onto the pipe end. The Flange Gasket shall always be assembled with the color-coded lip on the pipe and the other lip facing the mating flange. When installed correctly, the lettering on the Flange Gasket will not be visible when viewing the face of the Style 741, 841, 743, or 744. Verify that no portion of the Flange Gasket extends into the groove of the pipe end.



**5. INSTALL STYLE 741, 841, 743, OR 744:** Install the hinged Style 741, 841, 743, or 744 around the grooved pipe end. Verify that the key section of the housings engages with the groove in the pipe end.



**6a. FOR STYLE 741, 841, AND STYLE 744 ONLY:** Closure lugs are provided for ease of installation. Clamp both lugs with a wrench or pliers to bring the lap-joint bolt holes into alignment.

Style 741, 841, and 744



Style 743



**6b.** Insert a standard full-shank-diameter assembly bolt through the two lap-joint bolt hole locations, as shown above. Refer to the applicable “Helpful Information” table on pages 212 – 215 for the required assembly bolt size and length. **NOTE:** Victaulic does not supply these assembly bolts.



**6c.** Verify that the Flange Gasket is still seated properly within the gasket pocket of the Style 741, 841, 743, or 744 and that the lettering on the Flange Gasket is not visible when viewing the face of the Style 741, 841, 743, or 744.



**7. JOIN STYLE 741, 841, 743, OR 744 AND MATING FLANGE:** Insert the assembly bolts, installed in step 6b, into the mating flange holes. Tighten a nut onto each bolt to prevent the bolts from pulling out.



**8. INSTALL REMAINING STANDARD FULL-SHANK-DIAMETER ASSEMBLY BOLT/NUTS:** Insert a standard full-shank diameter assembly bolt through each remaining hole in the Style 741, 841, 743, or 744 and mating flange. Tighten a nut onto each bolt.

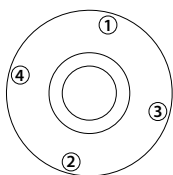

4-Bolt Tightening Pattern

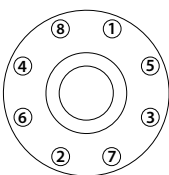

8-Bolt Tightening Pattern

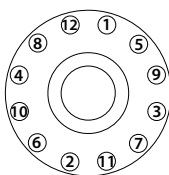

12-Bolt Tightening Pattern

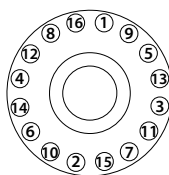

16-Bolt Tightening Pattern



**9. TIGHTEN NUTS:** Tighten all nuts evenly in the applicable pattern shown above until metal-to-metal contact is achieved between the flange faces or the flange-bolt torque requirement for the mating flange is achieved.

### Style 741, 841, and 744 (ANSI Class 125 and 150) and Australian Standard Table “E” Helpful Information

Nominal Pipe Size inches/DN	Actual Pipe Outside Diameter inches/mm	Standard Full-Shank-Diameter Assembly Bolts/Nuts †				Socket Size inches
		Number of Bolts/Nuts Required		Bolt/Nut Size x Length inches		
		Style 741/841#	Style 744	Style 741/841#	Style 744	
2* DN50	2.375 60.3	4	4	5/8 x 2 3/4	5/8 x 2 3/4	1 1/16
2 1/2	2.875 73.0	4	4	5/8 x 3	5/8 x 3	1 1/16
3* DN80	3.500 88.9	4	4	5/8 x 3	5/8 x 3	1 1/16
4* DN100	4.500 114.3	8	8	5/8 x 3	5/8 x 3	1 1/16
5	5.563 141.3	8	8	3/4 x 3 1/2	3/4 x 3 1/2	1 1/4
6* DN150	6.625 168.3	8	8	3/4 x 3 1/2	3/4 x 3 1/2	1 1/4
8* DN200	8.625 219.1	8	8	3/4 x 3 1/2	3/4 x 3 1/2	1 1/4
10 DN250	10.750 273.0	12	—	7/8 x 4	—	1 7/16
12 DN300	12.750 323.9	12	—	7/8 x 4	—	1 7/16

\*Australian Standard Table “E” Flanges are available in these sizes.

† Victaulic does not supply the standard full-shank-diameter assembly bolts and nuts. Standard full-shank-diameter assembly bolts are required for proper installation of the Style 741, 841, and 744.

**Fully-threaded bolts shall not be used.** The assembly bolt sizes listed above are for conventional flange-to-flange connections. Longer bolts are required when the Style 741, 841, and 744 are used with wafer-type valves.

# The Style 841 may not be available in all sizes listed.

**NOTE:** The Style 741, 841, and 743 provide rigid joints when used on pipe that is cut or roll grooved to Victaulic OGS specifications. Consequently, no linear or angular movement is allowed at the joint.



## Style 741 PN10 and PN16 Helpful Information

Nominal Pipe Size DN/inches	Actual Pipe Outside Diameter mm/inches	Standard Full-Shank-Diameter Assembly Bolts/ Nuts †		Socket Size mm	Standard Full-Shank-Diameter Assembly Bolts/ Nuts †		Socket Size mm
		No. of Bolts/ Nuts Req.	Bolt/Nut Size x Length mm		No. of Bolts/ Nuts Req.	Bolt/Nut Size x Length mm	
		PN10 Flanges			PN16 Flanges		
DN50 2	60.3 2.375	4	M16 x 70	27	4	M16 x 70	27
DN65	76.1 3.000	4	M16 x 70	27	4	M16 x 70	27
DN80 3	88.9 3.500	8	M16 x 70	27	8	M16 x 70	27
DN100 4	114.3 4.500	8	M16 x 76	27	8	M16 x 76	27
DN125	139.7 5.500	8	M16 x 76	27	8	M16 x 76	27
	159.0 6.250	8	M20 x 89	32	8	M20 x 89	32
	165.1 6.500	8	¾ x 3 ½ inch	1 ¼ inch	8	¾ x 3 ½ inch	1 ¼ inch
DN150 6	168.3 6.625	8	M20 x 89	32	8	M20 x 89	32
DN200 8	219.1 8.625	8	M20 x 89	32	12	M20 x 89	32
DN250 10	273.0 10.750	12	M20 x 89	32	12	M24 x 90	41
DN300 12	323.9 12.750	12	M20 x 89	32	12	M24 x 90	41

† Victaulic does not supply the standard full-shank-diameter assembly bolts and nuts. Standard full-shank-diameter assembly bolts are required for proper installation of the Style 741. **Fully-threaded bolts shall not be used.** The assembly bolt sizes listed above are for conventional flange-to-flange connections. Longer bolts are required when the Style 741 is used with wafer-type valves.

**NOTE:** The Style 741 provides a rigid joint when used on pipe that is cut or roll grooved to Victaulic OGS specifications. Consequently, no linear or angular movement is allowed at the joint.

Contact Victaulic for information on ISO 2084 (PN10); DIN 2532 (PN10); and JIS B-2210 (10K) flanges.

## Style 741 Chinese Standard Table “E” Helpful Information

Nominal Pipe Size DN/inches	Actual Pipe Outside Diameter mm/inches	Standard Full-Shank-Diameter Assembly Bolts/Nuts †		Socket Size mm
		Number of Bolts/Nuts Required	Bolt/Nut Size x Length mm	
DN50 2	60.3 2.375	4	M16 x 70	27
DN65	76.1 3.000	4	M16 x 70	27
DN80 3	88.9 3.500	8	M16 x 76	27
	108.0 4.250	8	M16 x 76	27
DN100 4	114.3 4.500	8	M16 x 76	27
	133.0 5.250	8	M16 x 76	27
DN125	139.7 5.500	8	M16 x 76	27
	159.0 6.250	8	M20 x 89	32
	165.1 6.500	8	M20 x 89	32
DN200 8	219.1 8.625	12	M20 x 89	32

† Victaulic does not supply the standard full-shank-diameter assembly bolts and nuts. Standard full-shank-diameter assembly bolts are required for proper installation of the Style 741. **Fully-threaded bolts shall not be used.** The assembly bolt sizes listed above are for conventional flange-to-flange connections. Longer bolts are required when the Style 741 is used with wafer-type valves.

**NOTE:** The Style 741 provides a rigid joint when used on pipe that is cut or roll grooved to Victaulic OGS specifications. Consequently, no linear or angular movement is allowed at the joint.

Contact Victaulic for information on ISO 2084 (PN10); DIN 2532 (PN10); and JIS B-2210 (10K) flanges.

## Style 743 (ANSI Class 250 and 300) Helpful Information

Nominal Pipe Size inches/DN	Actual Pipe Outside Diameter inches/mm	Standard Full-Shank-Diameter Assembly Bolts/Nuts †		Socket Size inches
		Number of Bolts/Nuts Required	Bolt/Nut Size x Length inches	
2 DN50	2.375 60.3	8	5/8 x 3	1 1/16
2 1/2	2.875 73.0	8	3/4 x 3 1/4	1 1/4
3 DN80	3.500 88.9	8	3/4 x 3 1/2	1 1/4
4 DN100	4.500 114.3	8	3/4 x 3 3/4	1 1/4
5	5.563 141.3	8	3/4 x 4	1 1/4
6 DN150	6.625 168.3	12	3/4 x 4 1/2	1 1/4
8 DN200	8.625 219.1	12	7/8 x 4 3/4	1 7/16
10 DN250	10.750 273.0	16	1 x 5 1/4	1 5/8
12 DN300	12.750 323.9	16	1 1/8 x 5 3/4	1 13/16

† Victaulic does not supply the standard full-shank-diameter assembly bolts and nuts. Standard full-shank-diameter assembly bolts are required for proper installation of the Style 743. **Fully-threaded bolts shall not be used.** The assembly bolt sizes listed above are for conventional flange-to-flange connections. Longer bolts are required when the Style 743 is used with wafer-type valves.

**NOTE:** The Style 743 provides a rigid joint when used on pipe that is cut or roll grooved to Victaulic OGS specifications. Consequently, no linear or angular movement is allowed at the joint.

# VICTAULIC FLANGE ADAPTER NOTES FOR 14 – 24-INCH/DN350 – DN600 SIZES OF STYLE 741 OGS *VIC-FLANGE* ADAPTERS

---

- The Style 741 shall not be used as anchor points for tie rods across non-restrained joints.
- If the Style 741 will be used on more than one outlet of an OGS grooved fitting, verify that there will not be interference between the flanges prior to installation.
- The Style 741 Flange Gasket shall always be assembled with the color-coded lip on the pipe and the other lip facing the mating flange. When installed correctly, the lettering on the Flange Gasket will not be visible when viewing the face of the Style 741 prior to attaching the mating flange.
- Refer to the “Victaulic Flange Washer and Transition Ring Notes” section on the following page for details regarding applications that require a Victaulic Flange Washer or Transition Ring.
- **STANDARD FULL-SHANK DIAMETER ASSEMBLY BOLTS (NOT SUPPLIED) ARE REQUIRED FOR PROPER INSTALLATION OF THE STYLE 741. FULLY-THREADED BOLTS SHALL NOT BE USED.**
- **THE MATING FLANGE SHALL HAVE THE SAME NUMBER OF BOLT HOLES AS THE STYLE 741.**

# VICTAULIC FLANGE WASHER AND TRANSITION RING NOTES FOR 14 – 24-INCH/DN350 – DN600 SIZES OF STYLE 741 OGS VIC-FLANGE ADAPTERS

Style 741 *Vic-Flange* Adapters require a smooth, hard surface at the mating flange face for effective sealing. Some applications, for which the Style 741 is otherwise well suited, do not provide an adequate mating surface. In such cases, a standard metallic Victaulic Flange Washer shall be inserted between the Style 741 and the mating flange to provide the necessary sealing surface. Refer to the example to the right.

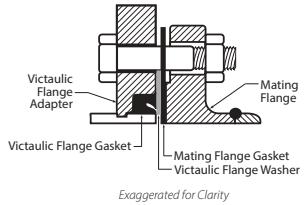

- The Style 741 is designed to mate to flanges with a sealing surface roughness conforming to ASME B16.5 requirements, without the use of a Victaulic Flange Washer and mating flange gasket. When mating to flanged components where the sealing surface roughness exceeds ASME B16.5 requirements, a standard metallic Victaulic Flange Washer and appropriate mating flange gasket are recommended.
- When mating a Style 741 to a rubber-faced or partially rubber-faced (smooth or not) piping component, a standard metallic Victaulic Flange Washer shall be placed between the valve and the Style 741.

- When mating a Style 741 to piping components (valves, strainers, etc.) where the component flange face has an insert, perform a trial fit with the Victaulic Flange Gasket to determine if the insert's bolting falls within the Flange Gasket's inside diameter (ID), as shown to the right. If the insert's bolting does not fall within the Flange Gasket's ID, a standard metallic Victaulic Flange Washer and appropriate mating flange gasket are recommended.

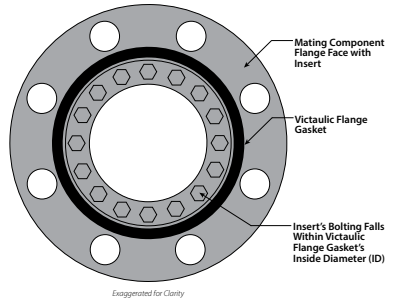

- When mating two Style 741 *Vic-Flange* Adapters, the Victaulic Flange Washer shall be placed between the two Victaulic Flange Adapters with the draw bolt locations staggered.
- When mating a Victaulic Style 341 AWWA *Vic-Flange* Adapter to a Style 741 or W741 in 14 – 24-inch/DN350 – DN600 sizes, the Victaulic Flange Transition Ring, rather than a Victaulic Flange Washer, shall be placed between the two Victaulic Flange Adapters with the draw bolt locations staggered. If the AWWA flange is not a Victaulic Style 341 (i.e. flanged valve), an appropriate mating flange gasket shall be placed against the non-Victaulic flanged component. The standard metallic Victaulic Flange Washer shall then be inserted between the mating flange gasket and the Victaulic Flange Gasket, as shown at the top of this page.

## NOTICE

- When a Victaulic flange solution is needed to connect components made from dissimilar metals, the system shall be reviewed for the potential of galvanic corrosion. If warranted, a bolt isolation kit shall be used on the flanged connection, along with a phenolic flange washer (instead of a standard metallic Victaulic Flange Washer).
- Always reference the bolt isolation kit manufacturer's installation instructions. A qualified engineer or system designer shall ultimately review and approve any solution for galvanic protection of a system.

**! WARNING**



- Read and understand all instructions before attempting to install any Victaulic products.
- Always verify that the piping system has been completely depressurized and drained immediately prior to installation, removal, adjustment, or maintenance of any Victaulic products.
- Confirm that any equipment, branch lines, or sections of piping that may have been isolated for/during testing or due to valve closures/positioning are identified, depressurized, and drained immediately prior to installation, removal, adjustment, or maintenance of any Victaulic products.
- These installation instructions are intended for an experienced, trained installer. The installer shall understand the use of this product and why it was specified for the particular application.
- The installer shall understand common industry safety standards and potential consequences of improper product installation.
- Wear safety glasses, hardhat, and foot protection.

Failure to follow these instructions could result in death or serious personal injury and property damage.

OGS Roll Groove Profile Shown



*Pipe and groove are not shown to scale*

Style 741 Vic-Flange Adapters shall be used ONLY with pipe that is prepared to Victaulic OGS groove specifications. **DO NOT** attempt to install these flange adapters on pipe that is prepared to any other groove specification.

**1a. CHECK PIPE END:** The outside surface of the pipe, between the groove and the pipe end, shall be generally free from indentations, projections, weld seam anomalies, and roll marks to ensure a leak-tight seal. All oil, grease, loose paint, dirt, and cutting particles shall be removed. Always verify that the correct groove profile is being used.

The pipe's outside diameter ("OD"), groove dimensions, and maximum allowable flare diameter shall be within the tolerances listed in this handbook for Victaulic OGS groove specifications.

**THE STYLE 741 ASSEMBLY (14 – 24-INCH/DN350 – DN600 SIZES) HAS A TORQUE REQUIREMENT. REFER TO THE INSTRUCTIONS ON THE FOLLOWING PAGES OR THE MARKINGS ON THE HOUSINGS FOR THE TORQUE REQUIREMENT.**

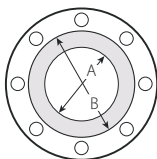

**1b. CHECK MATING FLANGE:** The gray area of the mating flange face (shown to the left) shall be generally free from gouges, undulations, and deformities of any type for proper sealing. Refer to the table below for the required mating flange face sealing surface.

Nominal Pipe Size inches/DN	Actual Pipe Outside Diameter inches/mm	Required Mating Flange Face Sealing Surface inches/mm	
		“A” Maximum	“B” Minimum
14 DN350	14.000 355.6	14.00 356	16.39 416
16 DN400	16.000 406.4	16.00 406	18.39 467
18 DN450	18.000 457.0	18.00 457	20.00 508
20 DN500	20.000 508.0	20.00 508	22.50 572
24 DN600	24.000 610.0	24.00 610	27.75 705

## NOTICE

- Verify that there is sufficient clearance behind the groove to permit proper assembly of the Style 741.
- Pipe support shall be maintained throughout the entire installation procedure.



**2. INSTALL FIRST SEGMENT:** Install the first segment onto the pipe. Verify that the segment's key section completely engages the groove. **NOTE:** On vertical pipe, the segments shall be supported in place until all segments are installed and fastened together. For horizontal pipe, the first segment can be balanced on top of the pipe, as shown to the left.



**3. INSTALL ADDITIONAL SEGMENTS:** Install each segment onto the pipe. Install the provided draw bolts into the Style 741, as shown to the left. Thread a provided nut loosely onto each draw bolt. **NOTE:** The nut should be installed at least flush with the end of the draw bolt but loose enough to permit rotation of the Style 741 for bolt hole alignment in later steps. Verify that the key section of all segments completely engages the groove.

**4a. CHECK FLANGE GASKET:** Check the Flange Gasket to verify that it is suitable for the intended service. The color code identifies the material grade. Refer to the “Gasket Color Code Reference” table in this handbook. For complete compatibility information, reference Victaulic publications 05.01 and GSG-100, which can be downloaded at victaulic.com.

**! CAUTION**

- A thin coat of a compatible lubricant shall be applied to the Flange Gasket's sealing lips and exterior to help prevent the Flange Gasket from pinching, rolling, or tearing during installation.
- DO NOT use excessive lubricant on the Flange Gasket's sealing lips and exterior. Failure to use a compatible lubricant may cause Flange Gasket damage, resulting in joint leakage and property damage.



**4b. LUBRICATE FLANGE GASKET:**

Apply a thin coat of a compatible lubricant to the Flange Gasket's sealing lips and exterior. Refer to the “Lubricant Compatibility for Gaskets” table in this handbook. **NOTE:** This Flange Gasket is designed to provide the sole seal. However, reference shall be made to the “Victaulic Flange Washer and Transition Ring Notes” section on page 217 for special applications.

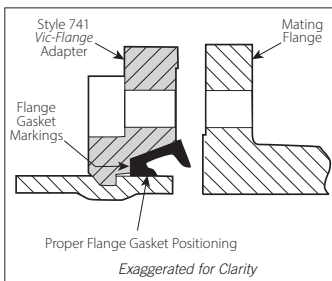

**5. POSITION AND INSTALL FLANGE GASKET:** Verify that the Flange Gasket is positioned properly, then install the Flange Gasket into the gasket pocket (cavity between the pipe OD and flange recess). The Flange Gasket shall always be assembled with the color-coded lip on the pipe and the other lip facing the mating flange. When installed correctly, the lettering on the Flange Gasket will not be visible when viewing the face of the Style 741.



**6. ALIGN 741 AND MATING FLANGE:**

Rotate the Style 741 on the pipe end, as required, to align the holes with the mating flange.

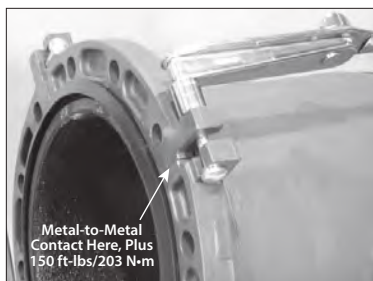

#### 7. TIGHTEN DRAW BOLT NUTS:

Tighten the draw bolt nuts evenly by alternating draw bolt locations, maintaining nearly uniform bolt pad gaps during tightening. **Continue to tighten the draw bolt nuts evenly by alternating draw bolt locations until metal-to-metal contact occurs in the area indicated AND a torque of 150 ft-lbs/203 N•m are achieved.**

Refer to the “Helpful Information” table on page 222 for the draw bolt/nut sizes and socket sizes. **NOTE:** Deep-well sockets are required for proper installation due to the longer draw bolt lengths associated with the Style 741.



#### 8. INSTALL STANDARD FULL-SHANK-DIAMETER ASSEMBLY BOLTS AT LAP JOINTS:

Install a standard full-shank-diameter assembly bolt into each of the lap-joint bolt holes. Refer to the “Helpful Information” table on page 222 for the required assembly bolt size and length. **NOTE:** Victaulic does not supply these assembly bolts.



#### 9. JOIN 741 AND MATING FLANGE:

Insert the assembly bolts, installed in step 8, into the mating flange holes. Tighten a nut onto each bolt to prevent the bolts from pulling out.



#### 10a. INSTALL REMAINING STANDARD FULL-SHANK-DIAMETER ASSEMBLY BOLTS/NUTS:

Insert a standard full-shank diameter assembly bolt through each remaining hole in the Style 741 and mating flange. Tighten a nut onto each bolt.

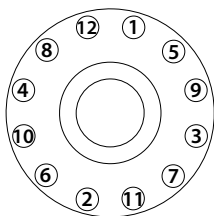

14-inch/DN350  
Size

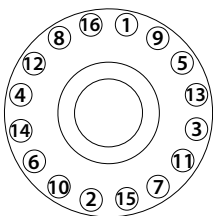

16 – 18-inch/DN400 – DN450  
Sizes

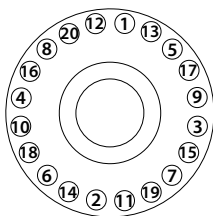

20 – 24-inch/DN500 – DN600  
Sizes



**10b. TORQUE ALL STANDARD FULL-SHANK-DIAMETER ASSEMBLY BOLTS:**

Tighten all nuts evenly in the applicable pattern shown above until the required torque value is achieved. Refer to the “Required Torque” table below.

**Required Torque**

Nominal Pipe Size inches/DN	Actual Pipe Outside Diameter inches/mm	Required Torque
14 – 16 DN350 – DN400	14.000 – 16.000 355.6 – 406.4	200 – 300 ft-lbs 271 – 407 N•m
18 – 20 DN450 – DN500	18.000 – 20.000 457.2 – 508.0	300 – 400 ft-lbs 407 – 542 N•m
24 DN600	24.000 609.6	400 – 500 ft-lbs 542 – 678 N•m

**Helpful Information**

Nominal Pipe Size inches/DN	Actual Pipe Outside Diameter inches/mm	Standard Full-Shank-Diameter Assembly Bolts/Nuts †			Draw Bolts/Nuts §		
		Number of Bolts/Nuts Required	Bolt/Nut Size x Length inches	Socket Size inches	Number of Bolts/Nuts Required	Bolt/Nut Size x Length inches	Socket Size inches
14 DN350	14.000 355.6	12	1 x 4 1/2	1 1/2	4	5/8 x 3 1/2	1 5/16
16 DN400	16.000 406.4	16	1 x 4 1/2	1 1/2	4	5/8 x 3 1/2	1 5/16
18 DN450	18.000 457.2	16	1 1/8 x 4 3/4	1 11/16	4	3/4 x 4 1/4	1 1/8
20 DN500	20.000 508.0	20	1 1/8 x 5 1/4	1 11/16	4	3/4 x 4 1/4	1 1/8
24 DN600	24.000 609.6	20	1 1/4 x 5 3/4	1 7/8	4	3/4 x 4 1/4	1 1/8

† Victaulic does not supply the standard full-shank-diameter assembly bolts and nuts. Standard full-shank-diameter assembly bolts are required for proper installation of Style 741 Vic-Flange Adapters. **Fully-threaded bolts shall not be used.** The assembly bolt sizes listed above are for conventional flange-to-flange connections. Longer bolts are required when the Style 741 is used with wafer-type valves.

§ Draw bolts/nuts are supplied with all Style 741 sizes listed in this table.



# GRINDING INSTRUCTIONS FOR PROJECTIONS ON STYLE 441 AND 743 FLANGE ADAPTERS

- The areas circled below identify the projections that shall be ground flush on **BOTH** segments of Style 441 and 743 Flange Adapters **ONLY** when being mated to flat-faced flanges without the use of a Victaulic Flange Washer, as noted previously. **DO NOT** grind these projections for any other applications.



Style 743 Shown

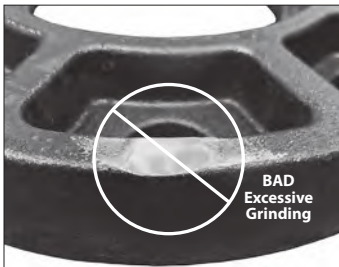
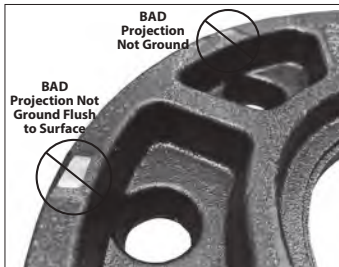
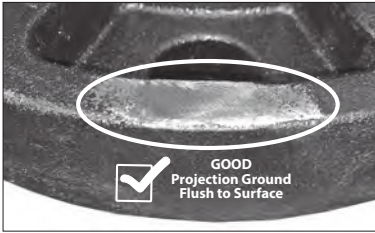

# GRINDING INSTRUCTIONS FOR TEETH ON STYLE 741, 841, AND 744 FLANGE ADAPTERS

- The areas circled below identify the teeth that shall be ground flush on **BOTH** segments of Style 741, 841, and 744 Flange Adapters **ONLY** when being mated to grooved-end Series 700 Butterfly Valves, Schedule 5 pipe, and plastic pipe. **DO NOT** grind these teeth for any other applications.

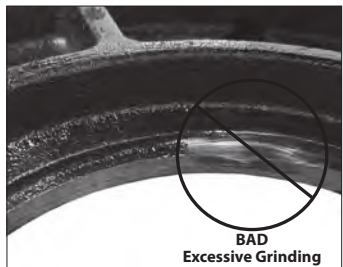
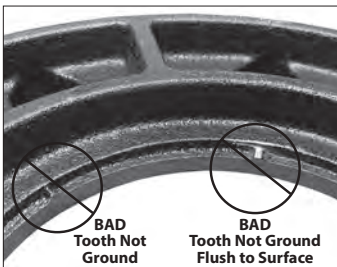

**Advanced Groove  
System *AGS*<sup>™</sup>  
*Vic-Flange* Adapter  
for AGS Grooved-  
End Pipe**

**Installation Instructions**

## VICTAULIC FLANGE ADAPTER NOTES FOR 14 – 24-INCH/DN350 – DN600 SIZES OF STYLE W741 VIC-FLANGE ADAPTERS

---

- The Style W741 shall not be used as anchor points for tie rods across non-restrained joints.
- If the Style W741 will be used on more than one outlet of an AGS grooved fitting, verify that there will not be interference between the flanges prior to installation.
- The Style W741 Flange Gasket shall always be assembled with the color-coded lip on the pipe and the other lip facing the mating flange. When installed correctly, the lettering on the Flange Gasket will not be visible when viewing the face of the Style W741 prior to attaching the mating flange.
- Refer to the “Victaulic Flange Washer and Transition Ring Notes” section on the following page for details regarding applications that require a Victaulic Flange Washer or Transition Ring.
- **STANDARD FULL-SHANK DIAMETER ASSEMBLY BOLTS (NOT SUPPLIED) ARE REQUIRED FOR PROPER INSTALLATION OF THE STYLE W741. FULLY-THREADED BOLTS SHALL NOT BE USED.**
- **THE MATING FLANGE SHALL HAVE THE SAME NUMBER OF BOLT HOLES AS THE STYLE W741.**

# VICTAULIC FLANGE WASHER AND TRANSITION RING NOTES FOR 14 – 24-INCH/DN350 – DN600 SIZES OF STYLE W741 **AGS** VIC-FLANGE ADAPTERS

Style W741 *Vic-Flange* Adapters require a smooth, hard surface at the mating flange face for effective sealing. Some applications, for which the Style W741 is otherwise well suited, do not provide an adequate mating surface. In such cases, a standard metallic Victaulic Flange Washer shall be inserted between the Style W741 and the mating flange to provide the necessary sealing surface. Refer to the example to the right.

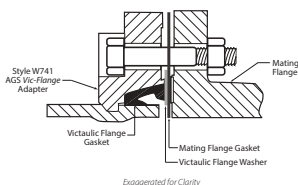

- The Style W741 is designed to mate to flanges with a sealing surface roughness conforming to ASME B16.5 requirements, without the use of a Victaulic Flange Washer and mating flange gasket. When mating to flanged components where the sealing surface roughness exceeds ASME B16.5 requirements, a standard metallic Victaulic Flange Washer and appropriate mating flange gasket are recommended.
- When mating a Style W741 to a rubber-faced or partially rubber-faced (smooth or not) piping component, a standard metallic Victaulic Flange Washer shall be placed between the valve and the Style W741.

- When mating a Style W741 to piping components (valves, strainers, etc.) where the component flange face has an insert, perform a trial fit with the Victaulic Flange Gasket to determine if the insert's bolting falls within the Flange Gasket's inside diameter (ID), as shown to the right. If the insert's bolting does not fall within the Flange Gasket's ID, a standard metallic Victaulic Flange Washer and appropriate mating flange gasket are recommended.

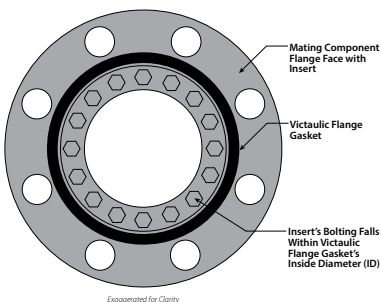

- When mating two Style W741 *Vic-Flange* Adapters, the Victaulic Flange Washer shall be placed between the two Victaulic Flange Adapters with the draw bolt locations staggered.
- When mating a Victaulic Style 341 AWWA *Vic-Flange* Adapter to a Style 741 or W741 in 14 – 24-inch/DN350 – DN600 sizes, the Victaulic Flange Transition Ring, rather than a Victaulic Flange Washer, shall be placed between the two Victaulic Flange Adapters with the draw bolt locations staggered. If the AWWA flange is not a flanged Style 341 (i.e. flanged valve), an appropriate mating flange gasket shall be placed against the non-Victaulic flanged component. The standard metallic Victaulic Flange Washer shall then be inserted between the mating flange gasket and the Victaulic Flange Gasket, as shown at the top of this page.

## NOTICE

- When a Victaulic flange solution is needed to connect components made from dissimilar metals, the system shall be reviewed for the potential of galvanic corrosion. If warranted, a bolt isolation kit shall be used on the flanged connection, along with a phenolic flange washer (instead of a standard metallic Victaulic Flange Washer).
- Always reference the bolt isolation kit manufacturer's installation instructions. A qualified engineer or system designer shall ultimately review and approve any solution for galvanic protection of a system.

**! WARNING**



- Read and understand all instructions before attempting to install any Victaulic products.
- Always verify that the piping system has been completely depressurized and drained immediately prior to installation, removal, adjustment, or maintenance of any Victaulic products.
- Confirm that any equipment, branch lines, or sections of piping that may have been isolated for/during testing or due to valve closures/positioning are identified, depressurized, and drained immediately prior to installation, removal, adjustment, or maintenance of any Victaulic products.
- These installation instructions are intended for an experienced, trained installer. The installer shall understand the use of this product and why it was specified for the particular application.
- The installer shall understand common industry safety standards and potential consequences of improper product installation.
- Wear safety glasses, hardhat, and foot protection.

Failure to follow these instructions could result in death or serious personal injury and property damage.

**! WARNING**

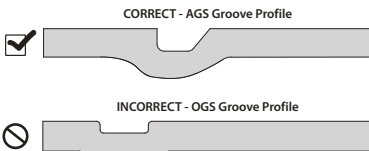

*Pipe and grooves are not shown to scale*

- **DO NOT** attempt to assemble the Style W741 on pipe that is grooved with OGS roll sets.

Failure to follow this instruction will cause improper assembly and joint failure, resulting in death or serious personal injury and property damage.

Style W741 AGS Vic-Flange Adapters shall be used ONLY with pipe that is prepared to Victaulic AGS groove specifications. **DO NOT** attempt to install these flange adapters on pipe that is prepared to any other groove specification.

**1a. CHECK PIPE END:** The outside surface of the pipe, between the groove and the pipe end, shall be generally free from indentations, projections, weld seam anomalies, and roll marks to ensure a leak-tight seal. All oil, grease, loose paint, dirt, and cutting particles shall be removed. Always verify that the correct groove profile is being used.

The pipe's outside diameter ("OD"), groove dimensions, and maximum allowable flare diameter shall be within the tolerances listed in this handbook for Victaulic AGS groove specifications.

**THE STYLE W741 ASSEMBLY HAS A TORQUE REQUIREMENT. REFER TO THE INSTRUCTIONS ON THE FOLLOWING PAGES OR THE MARKINGS ON THE HOUSINGS FOR THE TORQUE REQUIREMENT.**

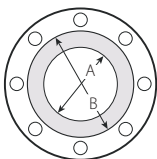

**1b. CHECK MATING FLANGE:** The gray area of the mating flange face (shown to the left) shall be generally free from gouges, undulations, and deformities of any type for proper sealing. Refer to the table below for the required flange mating face sealing surface.

Nominal Pipe Size inches/DN	Actual Pipe Outside Diameter inches/mm	Required Mating Face Sealing Surface inches/mm	
		"A" Max.	"B" Min.
14 DN350	14.000 355.6	14.00 356	16.00 406
16 DN400	16.000 406.4	16.00 406	18.00 457
18 DN450	18.000 457.2	18.00 457	20.00 508
20 DN500	20.000 508.0	20.00 508	22.00 559
24 DN600	24.000 609.6	24.00 610	26.00 660

## NOTICE

- Verify that there is sufficient clearance behind the groove to permit proper assembly of the Style W741.
- Pipe support shall be maintained throughout the entire installation procedure.



**2. INSTALL FIRST SEGMENT:** Install the first segment onto the pipe. Verify that the segment's key section completely engages the groove. **NOTE:** On vertical pipe, the first segment shall be supported in place until the second segment is installed and fastened to the first segment. For horizontal pipe, the first segment can be balanced on top of the pipe, as shown to the left.



**3. INSTALL SECOND SEGMENT:** Install the second segment onto the pipe. Install the provided draw bolts into the Style W741, as shown to the left. Thread a provided nut loosely onto each draw bolt. **NOTE:** The nut should be installed at least flush with the end of the draw bolt but loose enough to permit rotation of the Style W741 for bolt hole alignment in later steps. Verify that the key section of both segments completely engages the groove.

**4a. CHECK FLANGE GASKET:** Check the Flange Gasket to verify that it is suitable for the intended service. The color code identifies the material grade. **Refer to the "Gasket Color Code Reference" table in this handbook. For complete compatibility information, reference Victaulic publications 05.01 and GSG-100, which can be downloaded at victaulic.com.**

## ! CAUTION

- A thin coat of a compatible lubricant shall be applied to the Flange Gasket's sealing lips and exterior to help prevent the Flange Gasket from pinching, rolling, or tearing during installation.
- **DO NOT** use excessive lubricant on the Flange Gasket's sealing lips and exterior. Failure to use a compatible lubricant may cause Flange Gasket damage, resulting in joint leakage and property damage.



### 4b. LUBRICATE FLANGE GASKET:

Apply a thin coat of a compatible lubricant, Victaulic Lubricant or silicone grease, to the Flange Gasket's sealing lips and exterior (silicone spray is not a compatible lubricant). **NOTE:** This Flange Gasket is designed to provide the sole seal. However, reference shall be made to the notes at the beginning of this section for special applications.

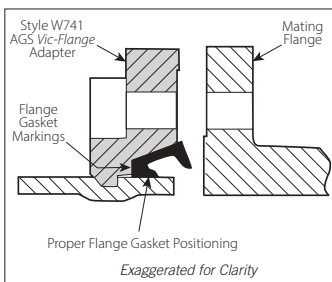

**5. POSITION AND INSTALL FLANGE GASKET:** Verify that the Flange Gasket is positioned properly, then install the Flange Gasket into the gasket pocket (cavity between the pipe OD and flange recess). The Flange Gasket shall always be assembled with the color-coded lip on the pipe and the other lip facing the mating flange. When installed correctly, the lettering on the Flange Gasket will not be visible when viewing the face of the Style W741.

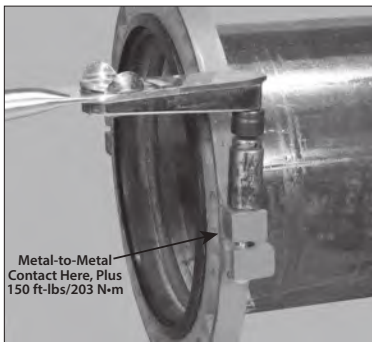

### 6. ALIGN W741 AND MATING FLANGE:

Rotate the Style W741 on the pipe end, as required, to align the holes with the mating flange.

### 7. TIGHTEN DRAW BOLT NUTS:

Tighten the draw bolt nuts evenly by alternating draw bolt locations, maintaining nearly uniform bolt pad gaps during tightening. **Continue to tighten the draw bolt nuts evenly by alternating draw bolt locations until metal-to-metal contact occurs in the area indicated AND a torque of 150 ft-lbs/203 N•m are achieved.**

Refer to the "Helpful Information" table on page 232 for the draw bolt/nut sizes and socket sizes. **NOTE:** Deep-well sockets are required for proper installation due to the longer draw bolt lengths associated with the Style W741.

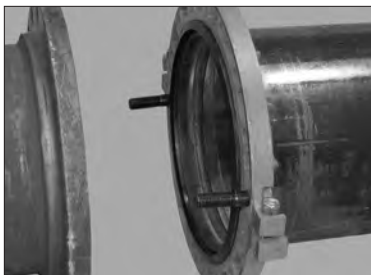

**8. INSTALL STANDARD FULL-SHANK-DIAMETER ASSEMBLY BOLTS AT LAP JOINTS:** Install a standard full-shank-diameter assembly bolt into each of the lap-joint bolt holes. Refer to the “Helpful Information” table on the following page for the required assembly bolt size and length. **NOTE:** Victaulic does not supply these assembly bolts.



**9. JOIN W741 AND MATING FLANGE:** Direct the assembly bolts, installed in step 8, into the mating flange holes. Tighten a nut onto each bolt to prevent the bolts from pulling out.

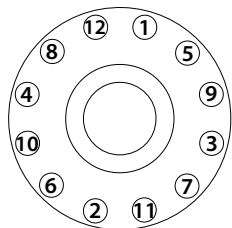
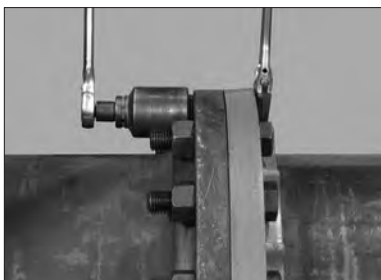

14-inch/DN350  
Size

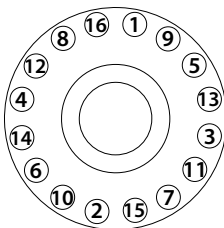

16 – 18-inch/DN400 – DN450  
Sizes

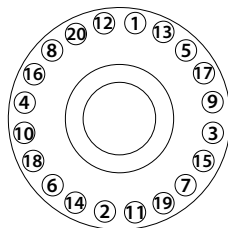

20 – 24-inch/DN500 – DN600  
Sizes

**10a. INSTALL REMAINING STANDARD FULL-SHANK-DIAMETER ASSEMBLY BOLTS/ NUTS:** Insert a standard full-shank diameter assembly bolt through each remaining hole in the Style W741 and mating flange. Tighten a nut onto each bolt.

**10b. TORQUE ALL STANDARD FULL-SHANK-DIAMETER ASSEMBLY BOLTS:** Tighten all nuts evenly in the applicable pattern shown above until the required torque value is achieved. Refer to the “Required Torque” table on the following page.

## Required Torque

Nominal Pipe Size inches/DN	Actual Pipe Outside Diameter inches/mm	Required Torque
14 – 16 DN350 – DN400	14.000 – 16.000 355.6 – 406.4	200 – 300 ft-lbs 271 – 407 N•m
18 – 20 DN450 – DN500	18.000 – 20.000 457.2 – 508.0	300 – 400 ft-lbs 407 – 542 N•m
24 DN600	24.000 609.6	400 – 500 ft-lbs 542 – 678 N•m

## Helpful Information

Nominal Pipe Size inches/DN	Actual Pipe Outside Diameter inches/mm	Standard Full-Shank-Diameter Assembly Bolts/Nuts †			Draw Bolts/Nuts §		
		Number of Bolts/Nuts Required	Bolt/Nut Size x Length inches	Socket Size inches	Number of Bolts/Nuts Required	Bolt/Nut Size x Length inches	Socket Size inches
14 DN350	14.000 355.6	12	1 x 4 ½	1 ½	2	5/8 x 3 ½	1 5/16
16 DN400	16.000 406.4	16	1 x 4 ½	1 ½	2	5/8 x 3 ½	1 5/16
18 DN450	18.000 457.2	16	1 1/8 x 4 ¾	1 11/16	2	¾ x 4 ¼	1 1/8
20 DN500	20.000 508.0	20	1 1/8 x 5 ¼	1 11/16	2	¾ x 4 ¼	1 1/8
24 DN600	24.000 609.6	20	1 ¼ x 5 ¾	1 7/8	2	¾ x 4 ¼	1 1/8

† Victaulic does not supply the full-shank-diameter assembly bolts and nuts. Standard full-shank-diameter assembly bolts are required for proper installation of Style W741 AGS *Vic-Flange* Adapters. **Fully-threaded bolts shall not be used.** The assembly bolt sizes listed above are for conventional flange-to-flange connections. Longer bolts are required when the Style W741 is used with wafer-type valves.

§ Draw bolts/nuts are supplied with all Style W741 sizes listed in this table.

# Couplings for Plain-End Pipe/Fittings

**Installation Instructions**

**Instructions for Reassembly**

## ! WARNING



- Read and understand all instructions before attempting to install any Victaulic products.
- Always verify that the piping system has been completely depressurized and drained immediately prior to installation, removal, adjustment, or maintenance of any Victaulic products.
- Confirm that any equipment, branch lines, or sections of piping that may have been isolated for/during testing or due to valve closures/positioning are identified, depressurized, and drained immediately prior to installation, removal, adjustment, or maintenance of any Victaulic products.
- These installation instructions are intended for an experienced, trained installer. The installer shall understand the use of this product and why it was specified for the particular application.
- The installer shall understand common industry safety standards and potential consequences of improper product installation.
- Wear safety glasses, hardhat, and foot protection.

Failure to follow these instructions could result in death or serious personal injury and property damage.

## NOTICE

- For proper assembly, both pipe/fitting ends shall be the same nominal size, schedule, and pipe material.
- Victaulic plain-end fittings shall be used with Style 99 Couplings.

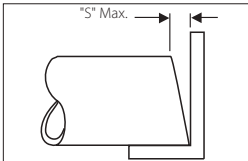

**1. PREPARE PLAIN-END PIPE:** Square cut the plain-end pipe ("S" dimension shown) to within:

$\frac{1}{32}$  inch/0.8 mm for 1 – 6-inch/DN25 – DN150 sizes

$\frac{1}{16}$  inch/1.6 mm for 8 – 12-inch/DN200 – DN300 sizes

**2. CHECK PIPE/FITTING ENDS:** The outside surface of the pipe/fitting ends shall be generally free from indentations and projections, within 1 ½ inches/38 mm from the ends, to ensure a leak-tight seal. All oil, grease, loose paint, dirt, and cutting particles shall be removed.

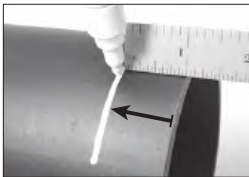

**3a. PLACE GASKET-CENTERING MARK ON PIPE/FITTING ENDS:** Using a measuring tape and a bright-colored pencil or paint stick, place a mark 1 inch/25 mm from the pipe/fitting ends. This mark will be used for reference in centering the gasket during installation. Make at least four marks, equally spaced around the circumference of the pipe/fitting ends.

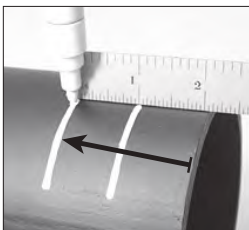

**3b. PLACE INSERTION DEPTH MARK ON PIPE/FITTING ENDS:** Refer to the "Pipe/Fitting Insertion Depth Requirements" table on the following page. Using a measuring tape and a bright-colored pencil or paint stick, place an additional mark from the pipe/fitting ends at the measurement listed in this table. This mark will be used for visual inspection to ensure that the pipe/fitting ends are inserted properly into the coupling. Make at least four marks, equally spaced around the circumference of the pipe/fitting ends.

## Pipe/Fitting Insertion Depth Requirements

Nominal Pipe Size inches/DN	Actual Pipe Outside Diameter inches/mm	Pipe/Fitting Insertion Depth (2nd Mark) inches/mm
1 DN25	1.315 33.7	1 ¼ 32
1 ½ DN40	1.900 48.3	1 ½ 38
2 DN50	2.375 60.3	1 ¾ 45
2 ½	2.875 73.0	1 ¾ 45
DN65	3.000 76.1	1 ½ 38
3 DN80	3.500 88.9	1 ¾ 45
3 ½ DN90	4.000 101.6	1 ⅞ 48
4 DN100	4.500 114.3	2 ⅞ 54
DN125	5.500 139.7	1 ¾ 45
5	5.563 141.3	2 ¼ 57
6 DN150	6.625 168.3	2 ¼ 57
	6.500 165.1	2 ¼ 57
8 DN200	8.625 219.1	2 ⅜ 61
10 DN250	10.750 273.0	2 ⅜ 61
12 DN300	12.750 323.9	2 ¼ 57

**4. CHECK GASKET:** Check the gasket to verify that it is suitable for the intended service. The color code identifies the material grade. Refer to page 32 for the “Gasket Color Code Reference” table. For complete compatibility information, reference Victaulic publications 05.01 and GSG-100, which can be downloaded at victaulic.com.

### CAUTION

- A thin coat of a compatible lubricant shall be applied to the gasket sealing lips and exterior to help prevent the gasket from pinching, rolling, or tearing during installation.
- DO NOT use excessive lubricant on the gasket sealing lips and exterior. Failure to use a compatible lubricant may cause gasket damage, resulting in joint leakage and property damage.

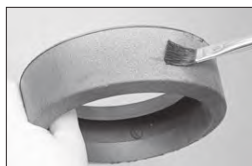

**5. LUBRICATE GASKET:** Apply a thin coat of a compatible lubricant to the gasket sealing lips and exterior. Refer to the “Lubricant Compatibility for Gaskets” table on page 34.



**6. INSTALL GASKET:** Install the gasket over the pipe/fitting end. **NOTE:** Verify that the gasket does not overhang the pipe/fitting end.

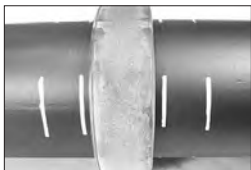

**7. JOIN PIPE/FITTING ENDS:** Align the centerlines of the two pipe/fitting ends and then bring the pipe/fitting ends together. Slide the gasket into position by centering it between the first set of marks. **NOTE:** The pipe/fitting ends should be butted; however, if a gap is present between the pipe/fitting ends, the gap shall not exceed ¼ inch/6.4 mm.

**! CAUTION**

- Verify that the gasket does not become rolled or pinched while installing the housings.

Failure to follow this instruction could cause gasket damage, resulting in joint leakage.

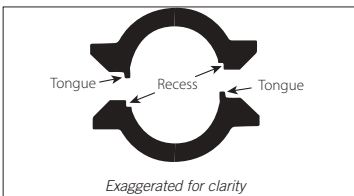

**8. INSTALL HOUSINGS:** Install the housings over the gasket with the tongue-and-recess features mated properly (tongue in recess). Verify that the housings are centered between the second set of marks. The second set of marks shall indicate full insertion into the coupling. **NOTE:** Style 99 Couplings in 1-inch/DN25, 1½-inch/DN40, DN65, and DN125 sizes do not contain the tongue-and-recess features.



**9. INSTALL BOLTS/NUTS:** Install the bolts, and thread a nut finger-tight onto each bolt.

For 6 – 12-inch/DN150 – DN300 sizes only, a flat washer shall be installed under each nut.

**NOTE:** Verify that the oval neck of each bolt seats properly in the bolt hole.

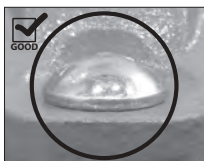

**OVAL NECK OF BOLT SEATED PROPERLY**



**OVAL NECK OF BOLT NOT SEATED PROPERLY**

## ! WARNING

- Always read and follow the “Victaulic End Cap Installation Safety Instructions” section in this handbook.
- Failure to follow the “Victaulic End Cap Installation Safety Instructions” section could result in death or serious personal injury and property damage.

- A No. 61P Bull Plug shall be used for direct connection to a Style 99 Coupling (verify compatibility of the No. 61P with the pipe material selected).
- Another option is to use a plain-end by grooved nipple and then attach an end cap to the grooved side by using a grooved pipe coupling. Contact Victaulic for additional information.
- Always confirm that any equipment, branch lines, or sections of piping that may have been isolated for/during testing or due to valve closures/positioning are identified, depressurized, and drained immediately prior to working with an end cap.

## ! WARNING

- For housings containing tongue-and-recess features, these features shall be mated properly (tongue in recess).
- Nuts shall be tightened evenly by alternating sides, maintaining nearly uniform bolt pad gaps, until all assembly requirements specified in steps 10 and 11 are achieved.
- Keep hands away from coupling openings during tightening.

Failure to tighten nuts as instructed will cause increased loading of the hardware, resulting in the following conditions:

- Excessive bolt torque required to assemble the joint (incomplete assembly)
- Damage to the assembled joint (damaged or broken bolt pads or fractures to housings)
- Bolt damage or fracture
- Joint leakage and property damage
- A negative impact on system integrity
- Personal injury or death

DO NOT continue to tighten the nuts after the assembly requirements specified in steps 10 and 11 are achieved.

- Failure to follow this instruction could result in the conditions listed above.

## NOTICE

- It is important to tighten the nuts evenly by alternating sides to prevent gasket pinching.
- An impact tool or standard socket wrench with a deep-well socket can be used to tighten the nuts.
- Refer to the “Impact Tool Usage Guidelines,” “Impact Tool Selection,” and “Torque Wrench Selection” sections in this handbook. In addition, refer to the “Assembly Torque Requirements” table on the following page and the “Helpful Information” table on page 239.



**10. TIGHTEN NUTS:** Using an impact tool or a standard socket wrench with a deep-well socket, tighten the nuts evenly by alternating sides until the gaps are equal at the bolt pads. Verify that the oval neck of each bolt seats properly in the bolt holes. **To complete the assembly, apply torque to each nut with a torque wrench.** Refer to the “Assembly Torque Requirements” table on the following page and the “Torque Wrench Selection” section in this handbook.

If you suspect that any hardware has been over-tightened (as indicated by a bend in the bolt, bulging of the nut at the bolt pad interface, or damage to the bolt pad, etc.), the entire coupling assembly shall be replaced immediately.

## ! WARNING

- Visual inspection of each joint is required.
- Improperly assembled joints shall be corrected before the system is filled, tested, or placed into service.
- Any components that exhibit physical damage due to improper assembly shall be replaced before the system is filled, tested, or placed into service.

Failure to follow these instructions could cause joint failure, resulting in death or serious personal injury and property damage.

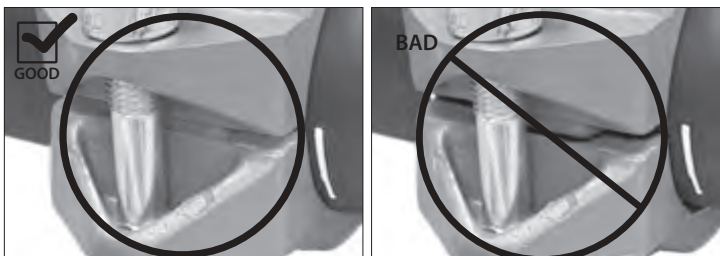

11. Visually inspect each bolt pad location at every joint to verify that proper assembly is achieved, in accordance with step 10.

### Assembly Torque Requirements

Nominal Pipe Size inches/DN	Actual Pipe Outside Diameter inches/mm	Required Assembly Torque
1 DN25	1.315 33.7	35 ft-lbs 48 N•m
1 ½ DN40	1.900 48.3	60 ft-lbs 81 N•m
2 DN50	2.375 60.3	150 ft-lbs 203 N•m
2 ½	2.875 73.0	150 ft-lbs 203 N•m
DN65	3.000 76.1	95 ft-lbs 129 N•m
3 DN80	3.500 88.9	200 ft-lbs 271 N•m
3 ½ DN90	4.000 101.6	200 ft-lbs 271 N•m
4 DN100	4.500 114.3	200 ft-lbs 271 N•m
DN125	5.500 139.7	160 ft-lbs 217 N•m
5	5.563 141.3	250 ft-lbs 339 N•m
6 DN150	6.625 168.3	250 ft-lbs 339 N•m
	6.500 165.1	250 ft-lbs 339 N•m
8 DN200	8.625 219.1	250 ft-lbs 339 N•m
10 DN350	10.750 273.0	300 ft-lbs 407 N•m
12 DN300	12.750 323.9	350 ft-lbs 475 N•m

## Helpful Information

Nominal Pipe Size inches/DN	Actual Pipe Outside Diameter inches/mm	Nut Size inches/ Metric	Deep-Well Socket Size inches/ mm
1 DN25	1.315 33.7	$\frac{3}{8}$ M10	$1\frac{1}{16}$ 17
1½ DN40	1.900 48.3	$\frac{1}{2}$ M12	$\frac{7}{8}$ 22
2 DN50	2.375 60.3	$\frac{5}{8}$ M16	1½ 27
2½	2.875 73.0	$\frac{5}{8}$ M16	1½ 27
DN65	3.000 76.1	$\frac{1}{2}$ M12	$\frac{7}{8}$ 22
3 DN80	3.500 88.9	$\frac{3}{4}$ M20	1¼ 32
3½ DN90	4.000 101.6	$\frac{3}{4}$ M20	1¼ 32
4 DN100	4.500 114.3	$\frac{3}{4}$ M20	1¼ 32
DN125	5.500 139.7	$\frac{3}{4}$ M20	1¼ 32
5	5.563 141.3	$\frac{7}{8}$ M22	1¾ 36
6 DN150	6.625 168.3	1 M24	1⅝ 41
	6.500 165.1	1 M24	1⅝ 41
8 DN200	8.625 219.1	$\frac{7}{8}$ M22	1¾ 36
10 DN350	10.750 273.0	$\frac{7}{8}$ M22	1¾ 36
12 DN300	12.750 323.9	1 M24	1⅝ 41

Continued on the following page

## Required Tangent Lengths for Plain-End Pipe Fittings (for Style 99 Couplings)

### WARNING

- The required tangent lengths, listed below, shall be used when connecting Style 99 Couplings to fittings for plain-end pipe.
- Failure to follow this instruction could cause joint failure, resulting in death or serious personal injury and property damage.

Style 99 Couplings require sufficient tangent lengths for proper assembly to fittings.

The following table applies to all fittings for plain-end pipe used with Style 99 Couplings (elbows, tees, laterals, wyes, crosses, bull plugs, and nipples).

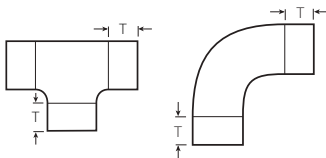

Nominal Pipe Size inches/DN	Actual Pipe Outside Diameter inches/mm	Required Minimum Tangent Length "T" inches/mm
1 DN25	1.315 33.7	1.25 32
1 ½ DN40	1.900 48.3	1.50 38
2 DN50	2.375 60.3	1.75 45
2 ½	2.875 73.0	1.75 45
DN65	3.000 76.1	1.50 38
3 DN80	3.500 88.9	1.75 45
3 ½ DN90	4.000 101.6	1.75 45
4 DN100	4.500 114.3	2.00 51
DN125	5.500 139.7	1.75 44.5
5	5.563 141.3	2.13 54
6 DN150	6.625 168.3	2.13 54
	6.500 165.1	2.13 54
8 DN200	8.625 219.1	2.25 57
10 DN350	10.750 273.0	2.25 57
12 DN300	12.750 323.9	2.25 57

### NOTICE

- For reassembly instructions, refer to page 246.

**! WARNING**



- Read and understand all instructions before attempting to install any Victaulic products.
- Always verify that the piping system has been completely depressurized and drained immediately prior to installation, removal, adjustment, or maintenance of any Victaulic products.
- Confirm that any equipment, branch lines, or sections of piping that may have been isolated for/during testing or due to valve closures/positioning are identified, depressurized, and drained immediately prior to installation, removal, adjustment, or maintenance of any Victaulic products.
- These installation instructions are intended for an experienced, trained installer. The installer shall understand the use of this product and why it was specified for the particular application.
- The installer shall understand common industry safety standards and potential consequences of improper product installation.
- Wear safety glasses, hardhat, and foot protection.

Failure to follow these instructions could result in death or serious personal injury and property damage.

**NOTICE**

- Style 99 Couplings in 14-inch/DN350 and larger sizes are cast in multiple housings to ease handling.
- For proper assembly, both pipe/fitting ends shall be the same nominal size, schedule, and pipe material.
- Victaulic plain-end fittings shall be used with Style 99 Couplings.

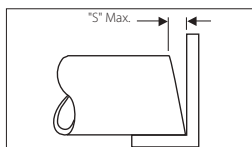

**1. PREPARE PLAIN-END PIPE:** Square cut the plain-end pipe (“S” dimension shown) to within 1/16 inch/ 1.6 mm.

**2. CHECK PIPE/FITTING ENDS:** The outside surface of the pipe/fitting ends shall be generally free from indentations and projections, within 1 1/2 inches/38 mm from the ends, to ensure a leak-tight seal. All oil, grease, loose paint, dirt, and cutting particles shall be removed.



**3a. PLACE GASKET-CENTERING MARK ON PIPE/FITTING ENDS:** Using a measuring tape and a bright-colored pencil or paint stick, place a mark 1 inch/25 mm from the pipe/fitting ends. This mark will be used for reference in centering the gasket during installation. Make at least four marks, equally spaced around the circumference of the pipe/fitting ends.

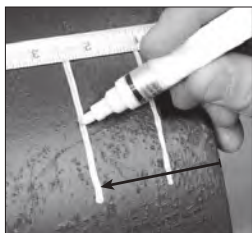

**3b. PLACE INSERTION DEPTH MARK ON PIPE/FITTING ENDS:** Refer to the “Pipe/Fitting Insertion Depth Requirements” table on the following page. Using a measuring tape and a bright-colored pencil or paint stick, place an additional mark from the pipe/fitting ends at the measurement listed in this table. This mark will be used for visual inspection to ensure that the pipe/fitting ends are inserted properly into the coupling. Make at least four marks, equally spaced around the circumference of the pipe/fitting ends.

## Pipe/Fitting Insertion Depth Requirements

Nominal Pipe Size inches/DN	Actual Pipe Outside Diameter inches/mm	Pipe/Fitting Insertion Depth (2nd Mark) inches/mm
14 – 18 DN350 – DN450	14.000 – 18.000 355.6 – 457.0	2 3/8 61

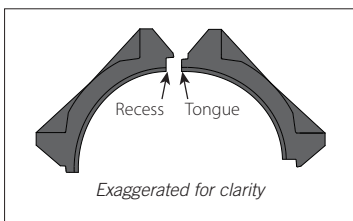
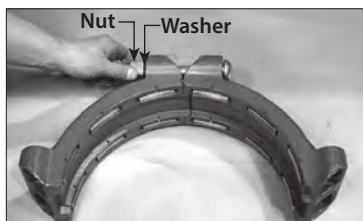

**4. ASSEMBLE HOUSINGS:** Assemble the housings into two equal halves with the tongue-and-recess features mated properly (tongue in recess), as shown above. Install a bolt into each hole location at the bolt pads. Install a flat washer onto the end of each bolt, then thread a nut finger-tight onto each bolt. **NOTE:** Verify that the oval neck of each bolt seats properly in the bolt hole. Tighten the nuts until metal-to-metal contact occurs at the bolt pads, then back the nuts off a full turn to provide spacing between the bolt pads.

**5. CHECK GASKET:** Check the gasket to verify that it is suitable for the intended service. The color code identifies the material grade. **Refer to page 32 for the “Gasket Color Code Reference” table. For complete compatibility information, reference Victaulic publications 05.01 and GSG-100, which can be downloaded at victaulic.com.**

### CAUTION

- A thin coat of a compatible lubricant shall be applied to the gasket sealing lips and exterior to help prevent the gasket from pinching, rolling, or tearing during installation.
- **DO NOT** use excessive lubricant on the gasket sealing lips and exterior. Failure to use a compatible lubricant may cause gasket damage, resulting in joint leakage and property damage.



**6. LUBRICATE GASKET:** Apply a thin coat of a compatible lubricant to the gasket sealing lips and exterior. Refer to the “Lubricant Compatibility for Gaskets” table on page 34.

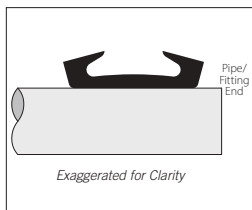

**7. INSTALL GASKET:** It may be easier to turn the gasket inside out to install it over the pipe/fitting end. **NOTE:** Verify that the gasket does not overhang the pipe/fitting end.

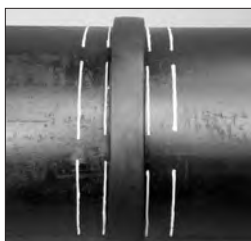

**8. JOIN PIPE/FITTING ENDS:** Align the centerlines of the two pipe/fitting ends and then bring the pipe/fitting ends together. **If the gasket was turned inside out in step 7**, roll the gasket into position and center it between the first set of marks. **NOTE:** The pipe/fitting ends should be butted; however, if a gap is present between the pipe/fitting ends, the gap shall not exceed ¼ inch/6.4 mm.

**! CAUTION**

- Verify that the gasket does not become rolled or pinched while installing the housings.

Failure to follow this instruction could cause gasket damage, resulting in joint leakage.



**9a. INSTALL FIRST PRE-ASSEMBLED HALF:** Install the first pre-assembled half over the gasket.

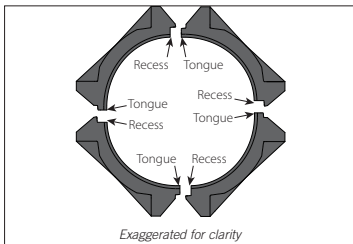

**9b. INSTALL REMAINING PRE-ASSEMBLED HALF:** Install the remaining pre-assembled half over the gasket. Verify that the tongue-and-recess features are mated properly (tongue in recess) and that the housings are centered between the second set of marks. The second set of marks shall indicate full insertion into the coupling. While supporting the weight of the assembly, install a bolt into each remaining hole location at the bolt pads. Install a flat washer onto the end of each bolt, then thread a nut finger-tight onto each bolt. **NOTE:** Verify that the oval neck of each bolt seats properly in the bolt hole.

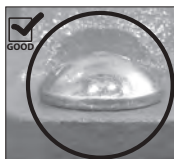

**OVAL NECK OF BOLT SEATED PROPERLY**

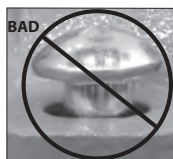

**OVAL NECK OF BOLT NOT SEATED PROPERLY**

## IMPORTANT INFORMATION FOR USE OF STYLE 99 COUPLINGS WITH END CAPS:

### **! WARNING**

- Always read and follow the “Victaulic End Cap Installation Safety Instructions” section in this handbook.

Failure to follow the “Victaulic End Cap Installation Safety Instructions” section could result in death or serious personal injury and property damage.

- Use a plain-end by grooved nipple and then attach an end cap to the grooved side by using a grooved pipe coupling. Contact Victaulic for additional information.
- Always confirm that any equipment, branch lines, or sections of piping that may have been isolated for/during testing or due to valve closures/positioning are identified, depressurized, and drained immediately prior to working with an end cap.

### **! WARNING**

- The housings' tongue-and-recess features shall be mated properly (tongue in recess).
- Nuts shall be tightened evenly by alternating bolt pad locations, maintaining nearly uniform bolt pad gaps, until all assembly requirements specified in steps 10 and 11 are achieved.
- Keep hands away from coupling openings during tightening.

Failure to tighten nuts as instructed will cause increased loading of the hardware, resulting in the following conditions:

- Excessive bolt torque required to assemble the joint (incomplete assembly)
- Damage to the assembled joint (damaged or broken bolt pads or fractures to housings)
- Bolt damage or fracture
- Joint leakage and property damage
- A negative impact on system integrity
- Personal injury or death

DO NOT continue to tighten the nuts after the assembly requirements specified in steps 4 and 5 are achieved.

- Failure to follow this instruction could result in the conditions listed above.

### **NOTICE**

- It is important to tighten the nuts evenly by alternating sides to prevent gasket pinching.
- An impact tool or standard socket wrench with a deep-well socket can be used to tighten the nuts.
- Refer to the “Impact Tool Usage Guidelines,” “Impact Tool Selection,” and “Torque Wrench Selection” sections in this handbook. In addition, refer to the “Assembly Torque Requirements” and “Helpful Information” tables on the following page.



**10. TIGHTEN NUTS:** Using an impact tool or a standard socket wrench with a deep-well socket, tighten the nuts evenly by alternating bolt pad locations until the gaps are equal at all bolt pads. Verify that the oval neck of each bolt seats properly in the bolt holes. **To complete the assembly, apply torque to each nut with a torque wrench.** Refer to the “Assembly Torque Requirements” table on the following page and the “Torque Wrench Selection” section in this handbook.

If you suspect that any hardware has been over-tightened (as indicated by a bend in the bolt, bulging of the nut at the bolt pad interface, or damage to the bolt pad, etc.), the entire coupling assembly shall be replaced immediately.

## ! WARNING

- Visual inspection of each joint is required.
- Improperly assembled joints shall be corrected before the system is filled, tested, or placed into service.
- Any components that exhibit physical damage due to improper assembly shall be replaced before the system is filled, tested, or placed into service.

Failure to follow these instructions could cause joint failure, resulting in death or serious personal injury and property damage.

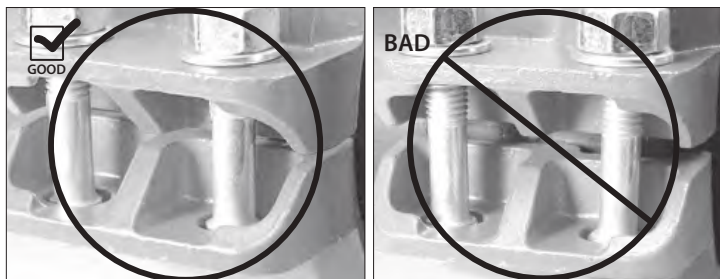

11. Visually inspect each bolt pad location at every joint to verify that proper assembly is achieved, in accordance with step 10.

### Assembly Torque Requirements

Nominal Pipe Size inches/DN	Actual Pipe Outside Diameter inches/mm	Required Assembly Torque
14 – 18 DN350 – DN450	14.000 – 18.000 355.6 – 457.0	350 ft-lbs 475 N·m

### Helpful Information

Nominal Pipe Size inches/DN	Actual Pipe Outside Diameter inches/mm	Nut Size inches/ Metric	Deep-Well Socket Size inches/ mm
14 – 18 DN350 – DN450	14.000 – 18.000 355.6 – 457.0	1 M24	1 5/8 41

*Continued on the following page*

## Required Tangent Lengths for Plain-End Pipe Fittings (for Style 99 Couplings)

### **! WARNING**

- The required tangent lengths, listed below, shall be used when connecting Style 99 Couplings to fittings for plain-end pipe.
- Failure to follow this instruction could cause joint failure, resulting in death or serious personal injury and property damage.

Style 99 Couplings require sufficient tangent lengths for proper assembly to fittings. The following table applies to all fittings for plain-end pipe used with Style 99 Couplings (elbows, tees, laterals, wyes, crosses, bull plugs, and nipples).

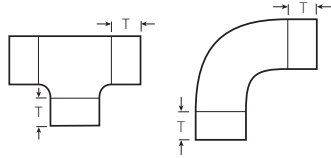

Nominal Pipe Size inches/DN	Actual Pipe Outside Diameter inches/mm	Required Minimum Tangent Length "T" inches/mm
14 – 18 DN350 – DN450	14.000 – 18.000 355.6 – 457.0	2.25 57

## INSTRUCTIONS FOR REASSEMBLY OF STYLE 99 COUPLINGS (ALL SIZES)

### **! WARNING**



- Always verify that the piping system has been completely depressurized and drained immediately prior to installation, removal, adjustment, or maintenance of any Victaulic products.
  - Confirm that any equipment, branch lines, or sections of piping that may have been isolated for/during testing or due to valve closures/positioning are identified, depressurized, and drained immediately prior to installation, removal, adjustment, or maintenance of any Victaulic products.
- Failure to follow this instruction could result in death or serious personal injury and property damage.

1. Verify that the system is depressurized and drained completely before attempting to disassemble any couplings.
2. Remove the nuts and bolts (and flat washers, if applicable) to permit removal of the coupling housings and gasket from the pipe/fitting ends.
3. Inspect the coupling housings. The teeth inside the coupling housings shall be free from any damage and debris. If any damage or wear is present on the teeth, use a new Victaulic-supplied coupling assembly and proceed to steps 6 and 7 below.

#### **If coupling housings can be reused:**

4. Inspect the nuts and bolts (and flat washers, if applicable) for any damage or wear. If any damage or wear is present, use new Victaulic-supplied hardware in the appropriate size for the coupling.
5. Inspect the gasket for any damage or wear. If any damage or wear is present, use a new Victaulic-supplied gasket in a material grade that is suitable for the intended service.
6. Inspect pipe/fitting ends. If pipe ends contain damage or scratches within 1 ½ inches/38 mm from the ends that cannot be removed by buffing, corrective action shall be taken by cutting off the pipe ends and preparing them in accordance with Steps 1 – 3b on page 234 or 241. Damaged fittings shall be replaced with new Victaulic-supplied fittings.
7. Re-install the coupling by following all instructions on the previous pages for the applicable coupling size.

# Hole-Cut Products

## Installation Instructions

**! WARNING**



- Read and understand all instructions before attempting to install any Victaulic products.
  - Always verify that the piping system has been completely depressurized and drained immediately prior to installation, removal, adjustment, or maintenance of any Victaulic products.
  - Confirm that any equipment, branch lines, or sections of piping that may have been isolated for/during testing or due to valve closures/positioning are identified, depressurized, and drained immediately prior to installation, removal, adjustment, or maintenance of any Victaulic products.
  - These installation instructions are intended for an experienced, trained installer. The installer shall understand the use of this product and why it was specified for the particular application.
  - The installer shall understand common industry safety standards and potential consequences of improper product installation.
  - Wear safety glasses, hardhat, and foot protection.
- Failure to follow these instructions could result in death or serious personal injury and property damage.

The Style 422 Stainless Steel *Mechanical-T* Outlet is designed to provide a direct branch connection.

The female threads of the Style 422 accommodate NPT (standard), BSPP (optional), or BSPT (optional) male pipe threads only. Use of male threaded products with special features, such as probes, dry pendent sprinkler heads, etc., shall be verified as suitable for use with this Victaulic product. Failure to verify suitability in advance may result in assembly issues or leakage, which can compromise system integrity and/or cause property damage.

**When the Style 422 is ordered with the BSPP thread option:** To create a pressure-tight seal per ISO 228-1, an appropriate seal (such as a bonded seal ring or an o-ring with retaining ring) shall be installed between the two mating surfaces outboard of the threads. **NOTE:** Victaulic does not supply the bonded seal ring or o-ring with retaining ring.

In addition, the Style 422 is available with Victaulic OGS or StrenThin™100 grooved outlets for connection to Victaulic OGS or StrenThin™100 grooved piping products.

## Pipe Preparation

### WARNING

- When cutting an outlet hole for the Style 422, **DO NOT** cut over a previously welded joint. The outlet hole shall be cut in a location that has not previously been altered or repaired.

Failure to follow these instructions could cause assembly failure, resulting in death or serious personal injury and property damage.

### NOTICE

- Victaulic hole cutting tools are recommended for proper outlet hole preparation.
  - To prevent contamination, use only hole saws that are designed for use with stainless steel material. **DO NOT** use a hole saw that was used previously to cut carbon steel pipe.
  - Always verify that coupons have been removed from the pipe after the outlet hole cutting process is complete.
  - The Style 422 is designed for use with stainless steel and HDPE pipe.
  - **DO NOT** use the Style 422 on CPVC or PVC plastic pipe.
  - **DO NOT** use the Style 422 in hot tapping applications.
1. The first step in the installation process is preparation of the pipe. Proper pipe preparation is required for sealing and performance.
  2. Pipe shall be supported during the outlet hole cutting process. Place a mark on the pipe at the specified outlet hole location.
  3. Verify that the correct hole saw is being used to cut the proper sized outlet hole at the specified location on the pipe. Refer to the "Pipe Preparation Dimensions" table on the following page.
  4. The outlet hole shall be drilled on center and perpendicular to the centerline of the pipe. Improperly cut outlet holes may prevent complete insertion of the locating collar and may prevent the product from sealing on the pipe surface.
  5. Remove any burrs and sharp edges from the outlet hole. Leftover burrs or sharp edges could affect engagement of the locating collar, flow from the outlet, or sealing of the gasket.
  6. Verify that the pipe surface within  $\frac{5}{8}$  inch/16 mm of the outlet hole is clean, smooth, and generally free from indentations and/or projections that could affect gasket sealing. The pipe around the entire circumference within the "A" dimension shall be generally free from any dirt, scratches, abrasions, or projections that may prevent the housing from seating fully on the pipe. Refer to the drawing to the right.

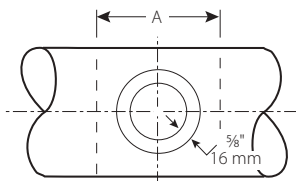

## Pipe Preparation Dimensions

Outlet Size	Minimum Outlet Hole Diameter/ Hole Saw Size inches/mm	Maximum Allowable Outlet Hole Diameter inches/mm	Surface Preparation "A" Dimension inches/mm
All ¾-inch/ 26.9-mm outlets	1½ 38	1⅝ 41	3½ 89
<i>Except for 6 x ¾-inch/ 168.3 x 26.9-mm outlets</i>	2 51	2⅛ 54	3½ 89
<i>Except for 8 x ¾-inch/ 219.1 x 26.9-mm and 10 x ¾-inch/ 273.0 x 26.9-mm outlets</i>	2¾ 70	2⅞ 73	3½ 89
All 1-inch/ 33.7-mm outlets	1½ 38	1⅝ 41	3½ 89
<i>Except for 6 x 1-inch/ 168.3 x 33.7-mm outlets</i>	2 51	2⅛ 54	3½ 89
<i>Except for 8 x 1-inch/ 219.1 x 33.7-mm and 10 x 1-inch/ 273.0 x 33.7-mm outlets</i>	2¾ 70	2⅞ 73	3½ 89
All 1½-inch/ 48.3-mm outlets	2 51	2⅛ 54	4 102
<i>Except for 8 x 1½-inch/ 219.1 x 48.3-mm and 10 x 1½-inch/ 273.0 x 48.3-mm outlets</i>	2¾ 70	2⅞ 73	4 102
All 2-inch/ 60.3-mm outlets	2½ 64	2⅝ 67	4½ 114
<i>Except for 8 x 2-inch/ 219.1 x 60.3-mm and 10 x 2-inch/ 273.0 x 60.3-mm outlets</i>	2¾ 70	2⅞ 73	4½ 114
All 3-inch/ 88.9-mm outlets	3½ 89	3⅝ 92	5½ 140
All 4-inch/ 114.3-mm outlets	4½ 114	4⅝ 118	6½ 165

## Installation

### CAUTION

- Verify that pipe is prepared properly in accordance with the instructions on the previous page. Failure to prepare pipe according to these instructions could cause improper gasket sealing, resulting in leakage and property damage.



- 1. ASSEMBLE HOUSINGS:** Insert a bolt into the two housings. Thread a nut loosely onto the bolt (nut should be flush with end of bolt).



**2. CHECK GASKET:** Check the gasket to verify that it is suitable for the intended service. The color code identifies the material grade. Refer to page 32 for the “Gasket Color Code Reference” table. For complete compatibility information, reference Victaulic publications 05.01 and GSG-100, which can be downloaded at [victaulic.com](http://victaulic.com). Inspect the sealing surface of the gasket to verify that no debris is present.

### CAUTION

- **DO NOT REMOVE THE GASKET FROM THE UPPER (OUTLET) HOUSING.**
- A thin coat of a compatible lubricant shall be applied **ONLY** to the exposed sealing surface of the gasket to help prevent the gasket from pinching, rolling, or tearing during installation.
- **DO NOT** use excessive lubricant on the exposed sealing surface of the gasket.
- When using the Style 422 with HDPE pipe, always consult the pipe manufacturer for lubricant compatibility requirements.

Failure to use a compatible lubricant may cause gasket damage, resulting in joint leakage and property damage.

**3. LUBRICATE GASKET:** DO NOT REMOVE THE GASKET FROM THE UPPER (OUTLET) HOUSING. Apply a thin coat of a compatible lubricant **ONLY** to the exposed sealing surface of the gasket. Refer to the “Lubricant Compatibility for Gaskets” table on page 34. When using the Style 422 with HDPE pipe, always consult the pipe manufacturer for lubricant compatibility requirements.



**4. INSTALL HOUSINGS:** Rotate the lower housing so that it is positioned approximately 90° to the upper (outlet) housing, as shown above. The upper (outlet) housing’s locating collar shall be placed into the outlet hole. Rotate the lower housing around the pipe.



**5. VERIFY LOCATING COLLAR ENGAGEMENT:**

Verify that the locating collar engages the outlet hole properly. Check this engagement by rocking the upper (outlet) housing in the outlet hole.

**NOTE:** The upper (outlet) housing should be flush to the pipe OD and should not be able to rotate.



**6. INSTALL REMAINING BOLT/NUT:** Insert the remaining bolt. Thread a nut onto the bolt finger-tight. **NOTE:** Verify that the oval neck of each bolt seats properly in the bolt hole.

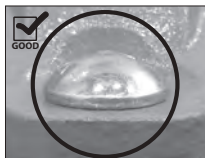

OVAL NECK OF BOLT SEATED PROPERLY



OVAL NECK OF BOLT NOT SEATED PROPERLY

## **! WARNING**

- Nuts shall be tightened evenly by alternating sides, maintaining nearly uniform bolt pad gaps, until all assembly requirements specified in step 7 are achieved.
- Keep hands away from housing openings during tightening.

Failure to tighten nuts as instructed will cause increased loading of the hardware, resulting in the following conditions:

- Excessive bolt torque required to assemble the joint (incomplete assembly)
- Damage to the assembled joint (damaged or broken bolt pads or fractures to housings)
- Bolt damage or fracture
- Joint leakage and property damage
- A negative impact on system integrity
- Personal injury or death

**DO NOT** continue to tighten the nuts after the assembly requirements specified in step 7 are achieved.

- Failure to follow this instruction could result in the conditions listed above.

## **NOTICE**

- It is important to tighten the nuts evenly by alternating sides to prevent gasket pinching.
- An impact tool or standard socket wrench with a deep-well socket can be used to tighten the hardware.
- For the 159.0-mm size, a box-end wrench **SHALL NOT** be used for installation. Box-end wrenches do not allow for full engagement of the nut during tightening.
- Refer to the “Impact Tool Usage Guidelines,” “Impact Tool Selection,” and “Torque Wrench Selection” sections in this handbook. In addition, refer to the “Helpful Information and Assembly Torque Requirements” table on the following page.



**7. TIGHTEN NUTS:** Verify that the locating collar is still positioned properly in the outlet hole. Using an impact tool or a standard socket wrench with a deep-well socket, tighten the nuts evenly by alternating sides, maintaining nearly uniform bolt pad gaps, until the upper (outlet) housing contacts the pipe completely. Verify that the oval neck of each bolt seats properly in the bolt holes. **To complete the assembly, apply torque to each nut with a torque wrench.** Refer to the “Helpful Information and Assembly Torque Requirements” table below and the “Torque Wrench Selection” section in this handbook.

**If you suspect that any hardware has been over-tightened (as indicated by a bend in the bolt, bulging of the nut at the bolt pad interface, or damage to the bolt pad, etc.), the entire outlet assembly shall be replaced immediately.**

## NOTICE

- For grooved outlets, refer to the applicable coupling installation instructions.
- For threaded outlets, complete the assembly using standard threading practices.

### BRANCH CONNECTIONS

If a branch connection is made to the upper (outlet) housing before the *Mechanical-T* is installed on the pipe, verify that the branch connection is 90° to the pipe before completing the tightening sequence of the *Mechanical-T* assembly.

- When the *Mechanical-T* is used as part of a connection between two parallel runs, it shall be assembled onto the runs before the branch connection is made.

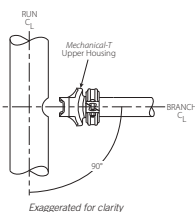

### Helpful Information and Assembly Torque Requirements

Nominal Pipe Size inches/DN	Actual Pipe Outside Diameter inches/mm	Nut Size inches/Metric	Deep-Well Socket Size inches/mm	Required Assembly Torques
3 – 4 DN80 – DN100	3.500 – 4.500 88.9 – 114.3	½ M12	⅞ 22	50 ft-lbs 68 N•m
6 DN150	6.625 168.3	⅝ M16	1 ⅛ 27	75 ft-lbs 102 N•m
8 DN200	8.625 219.1	¾ M20	1 ¼ 32	100 ft-lbs 136 N•m

**! WARNING**



- Read and understand all instructions before attempting to install any Victaulic products.
- Always verify that the piping system has been completely depressurized and drained immediately prior to installation, removal, adjustment, or maintenance of any Victaulic products.
- Confirm that any equipment, branch lines, or sections of piping that may have been isolated for/during testing or due to valve closures/positioning are identified, depressurized, and drained immediately prior to installation, removal, adjustment, or maintenance of any Victaulic products.
- Wear safety glasses, hardhat, and foot protection.
- The Style 912 FireLock™ Low-Profile Sprinkler-Tee shall be used only in fire protection systems that are designed and installed in accordance with current, applicable National Fire Protection Association (NFPA 13, 13D, 13R, etc.) standards, or equivalent standards, and in accordance with applicable building and fire codes. These standards and codes contain important information regarding protection of systems from freezing temperatures, corrosion, mechanical damage, etc.
- These installation instructions are intended for an experienced, trained installer. The installer shall understand the use of this product and why it was specified for the particular application.
- The installer shall understand common industry safety standards and potential consequences of improper product installation.

Failure to follow installation requirements and local and national codes and standards could compromise system integrity or cause system failure, resulting in death or serious personal injury and property damage.

The Style 912 FireLock™ Low-Profile Sprinkler-Tee is designed with female threads to ISO 7-Rp 1/2 (Rp 1/2 BSPP per BS21) and can accommodate male sprinkler or nozzle threads only. **FOR SPRINKLER OR NOZZLE USE ONLY. DO NOT USE AS A BRANCH OUTLET.** For complete listings and approvals, refer to Victaulic publication 10.53, which can be downloaded at [victaulic.com](http://victaulic.com).

To create a pressure-tight seal per ISO 228-1, an appropriate seal (such as a bonded seal ring or an o-ring with retaining ring) shall be installed between the two mating surfaces outboard of the threads. **NOTE:** Victaulic does not supply the bonded seal ring or o-ring with retaining ring.

### Pipe Preparation

**! WARNING**

- When cutting an outlet hole for the Style 912, **DO NOT** cut over a previously welded joint. The outlet hole shall be cut in a location that has not previously been altered or repaired.

Failure to follow these instructions could cause assembly failure, resulting in death or serious personal injury and property damage.

### NOTICE

- Victaulic hole cutting tools are recommended for proper outlet hole preparation.
- Always verify that coupons have been removed from the pipe after the outlet hole cutting process is complete.

1. The first step in the installation process is preparation of the pipe. Proper pipe preparation is required for sealing and performance.
2. Pipe shall be supported during the outlet hole cutting process. Place a mark on the pipe at the specified outlet hole location.

3. Verify that the correct hole saw is being used to cut the proper sized outlet hole at the specified location on the pipe. Refer to the “Pipe Preparation Dimensions” table below.
4. The outlet hole shall be drilled on center and perpendicular to the centerline of the pipe. Improperly cut outlet holes may prevent complete insertion of the locating collar and may prevent the product from sealing on the pipe surface.
5. Remove any burrs and sharp edges from the outlet hole. Leftover burrs or sharp edges could affect engagement of the locating collar, flow from the outlet, or sealing of the gasket.
6. Verify that the pipe surface within  $\frac{1}{4}$  inch/ 6 mm of the outlet hole is clean, smooth, and generally free from indentations and/or projections that could affect gasket sealing. The pipe around the entire circumference within the “A” dimension shall be generally free from any dirt, scratches, abrasions, or projections that may prevent the housing from seating fully on the pipe. Refer to the drawing to the right.

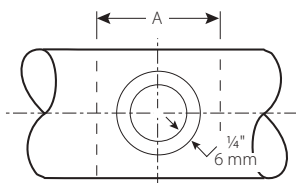

### Pipe Preparation Dimensions

	Minimum Outlet Hole Diameter/ Hole Saw Size inches/mm	Maximum Allowable Outlet Hole Diameter inches/mm	Surface Preparation “A” Dimension inches/mm
All Outlet Sizes	$\frac{1}{16}$ 24	1 25	3 76

### Installation

#### CAUTION

- Verify that pipe is prepared properly in accordance with the instructions on this page and the previous page.

Failure to prepare pipe according to these instructions could cause improper gasket sealing, resulting in leakage and property damage.

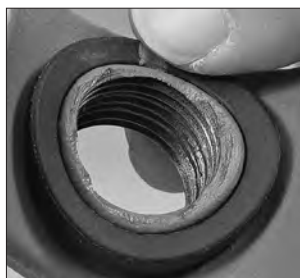

**1a. CHECK GASKET:** Check the gasket to verify that it is suitable for the intended service. The color code identifies the material grade. Refer to page 32 for the “Gasket Color Code Reference” table. For complete compatibility information, reference Victaulic publications 05.01 and GSG-100, which can be downloaded at [victaulic.com](http://victaulic.com).

**1b.** Inspect the sealing surface of the gasket to verify that no debris is present. Verify that the gasket is seated fully in the gasket pocket.

**DO NOT LUBRICATE THE GASKET.**



**2. ASSEMBLE HOUSINGS:** Remove the flange nut and bolt from one side of the Style 912 assembly. Thread the remaining flange nut loosely onto the bolt (flange nut should be flush with end of bolt) to allow for the “swing-over” feature.



**3a. INSTALL HOUSINGS:** Install the upper (outlet) housing onto the pipe by centering the locating collar in the outlet hole. To check for proper engagement, slide the upper (outlet) housing back and forth while pushing down. A properly positioned upper (outlet) housing will not be able to rotate around the pipe.

**3b.** While holding the upper (outlet) housing in place, rotate the lower housing around the pipe. Verify that the locating collar remains seated in the outlet hole.



**4. INSTALL REMAINING BOLT/FLANGE NUT:**

Insert the remaining bolt through the lower housing and upper (outlet) housing. Thread a flange nut onto the bolt. **NOTE:** Verify that the oval neck of each bolt seats properly in the bolt hole.

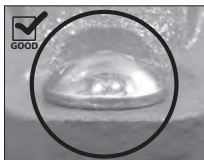

OVAL NECK OF BOLT SEATED PROPERLY



OVAL NECK OF BOLT NOT SEATED PROPERLY

**! WARNING**

- Flange nuts shall be tightened evenly by alternating sides, maintaining nearly uniform bolt pad gaps, until all assembly requirements specified in steps 5 – 6 are achieved.
- Keep hands away from housing openings during tightening.

Failure to tighten flange nuts as instructed will cause increased loading of the hardware, resulting in the following conditions:

- Excessive bolt torque required to assemble the joint (incomplete assembly)
- Damage to the assembled joint (damaged or broken bolt pads or fractures to housings)
- Over-compression of the gasket
- Bolt damage or fracture
- Joint leakage and property damage
- A negative impact on system integrity
- Personal injury or death

DO NOT continue to tighten the flange nuts after the assembly requirements specified in steps 5 – 6 are achieved.

- Failure to follow this instruction could result in the conditions listed above.

## NOTICE

- It is important to tighten the flange nuts evenly by alternating sides to prevent gasket pinching.
- To avoid over-tightening the flange nuts, use a wrench with a maximum length of 8 inches/200 mm.
- Use of an impact tool with this product is discouraged, due to the lower torque required for assembly.



**5. TIGHTEN FLANGE NUTS:** Verify that the locating collar is still positioned properly in the outlet hole. Tighten the flange nuts evenly by alternating sides, maintaining nearly uniform bolt pad gaps, to a maximum torque value of 20 ft-lbs/27 N•m to ensure proper gasket compression. Verify that the oval neck of each bolt seats properly in the bolt holes. Refer to the “Helpful Information” table below.

If you suspect that any hardware has been over-tightened (as indicated by a bend in the bolt, bulging of the nut at the bolt pad interface, or damage to the bolt pad, etc.), the entire outlet assembly shall be replaced immediately.

### Helpful Information

	Nut Size inches/Metric	Wrench/Socket Size inches/mm
All Sizes	$\frac{3}{8}$ M10	$\frac{9}{16}$ 15

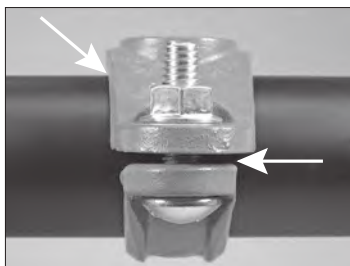
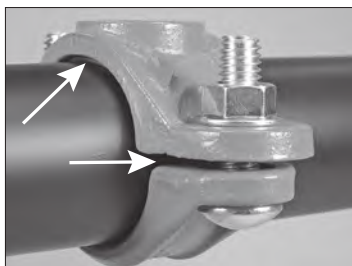

**6. INSPECT THE ASSEMBLY:** When the Style 912 is assembled correctly, the upper (outlet) housing, near the gasket, will not make metal-to-metal contact with the pipe. If there are gaps between the upper (outlet) housing's and lower housing's bolt pads, they shall be equal on both sides of the assembly.

Style 920 - Mechanical-T Outlet

Style 920N - Mechanical-T Outlet

Style L920N - Mechanical-T Outlet

## WARNING



- Read and understand all instructions before attempting to install any Victaulic products.
- Always verify that the piping system has been completely depressurized and drained immediately prior to installation, removal, adjustment, or maintenance of any Victaulic products.
- Confirm that any equipment, branch lines, or sections of piping that may have been isolated for/during testing or due to valve closures/positioning are identified, depressurized, and drained immediately prior to installation, removal, adjustment, or maintenance of any Victaulic products.
- Wear safety glasses, hardhat, and foot protection.
- When the Style 920 or 920N is used in fire protection applications, the system shall be designed and installed in accordance with current, applicable National Fire Protection Association (NFPA 13, 13D, 13R, etc.) standards, or equivalent standards, and in accordance with applicable building and fire codes. These standards and codes contain important information regarding protection of systems from freezing temperatures, corrosion, mechanical damage, etc.
- These installation instructions are intended for an experienced, trained installer. The installer shall understand the use of this product and why it was specified for the particular application.
- The installer shall understand common industry safety standards and potential consequences of improper product installation.

**Failure to follow installation requirements and local and national codes and standards could compromise system integrity or cause system failure, resulting in death or serious personal injury and property damage.**

Style 920, 920N, and L920N Mechanical-T Outlets are designed to provide a direct branch connection.

The female threads of the Style 920 and 920N accommodate standard NPT or BSPT male pipe threads only. The female threads of the Style L920N accommodate standard NPT male pipe threads only. Use of male threaded products with special features, such as probes, dry pendent sprinkler heads, etc., shall be verified as suitable for use with this Victaulic product. Failure to verify suitability in advance may result in assembly issues or leakage, which can compromise system integrity and/or cause property damage.

In addition, the Style 920 and 920N are available with Victaulic OGS grooved outlets for connection to Victaulic OGS grooved piping products.

## Pipe Preparation

### WARNING

- When cutting an outlet hole for the Style 920 or 920N/L920N, **DO NOT** cut over a previously welded joint. The outlet hole shall be cut in a location that has not previously been altered or repaired.

Failure to follow these instructions could cause assembly failure, resulting in death or serious personal injury and property damage.

### NOTICE

- Victaulic hole cutting tools are recommended for proper outlet hole preparation.
- Always verify that coupons have been removed from the pipe after the outlet hole cutting process is complete.
- **DO NOT** use the Style 920 or 920N/L920N on CPVC or PVC plastic pipe.
- **DO NOT** use the Style L920N on HDPE pipe.

1. The first step in the installation process is preparation of the pipe. Proper pipe preparation is required for sealing and performance.
2. Pipe shall be supported during the outlet hole cutting process. Place a mark on the pipe at the specified outlet hole location.
3. Verify that the correct hole saw is being used to cut the proper sized outlet hole at the specified location on the pipe. Refer to the "Pipe Preparation Dimensions" table on the following page.
4. The outlet hole shall be drilled on center and perpendicular to the centerline of the pipe. Improperly cut outlet holes may prevent complete insertion of the locating collar and may prevent the product from sealing on the pipe surface.
5. Remove any burrs and sharp edges from the outlet hole. Leftover burrs or sharp edges could affect engagement of the locating collar, flow from the outlet, or sealing of the gasket.
6. Verify that the pipe surface within  $\frac{5}{16}$  inch/16 mm of the outlet hole is clean, smooth, and generally free from indentations and/or projections that could affect gasket sealing. The pipe around the entire circumference within the "A" dimension shall be generally free from any dirt, scratches, abrasions, or projections that may prevent the housing from seating fully on the pipe. Refer to the drawing to the right.
7. Holes for cross assemblies shall be cut on the centerline of the pipe at predetermined locations for each branch, and shall be in line within  $\frac{1}{16}$  inch/1.6 mm of each other. Refer to the "Style 920 or 920N/L920N Cross Assemblies" section on page 263 for additional information.

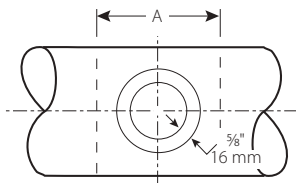

### WARNING

- For proper installation, some new sizes of Style 920N/L920N products require a different outlet hole size than the Style 920 or Style 921 that they replace. Verify that the proper size outlet hole is prepared for the size and style being installed (refer to the table on the following page for requirements).

Failure to follow these instructions could result in death or serious personal injury and property damage.

## Pipe Preparation Dimensions

Outlet Size	Minimum Outlet Hole Diameter/ Hole Saw Size inches/mm	Maximum Allowable Outlet Hole Diameter inches/mm	Surface Preparation "A" Dimension inches/mm
All ½-inch/ 21.3-mm outlets	1½ 38	1⅝ 41	3½ 89
All ¾-inch/ 26.9-mm outlets	1½ 38	1⅝ 41	3½ 89
All 1-inch/ 33.7-mm outlets	1½ 38	1⅝ 41	3½ 89
All 1¼-inch/ 42.4-mm outlets	1¾ 44	1⅞ 48	4 102
All 1½-inch/ 48.3-mm outlets	2 51	2⅛ 54	4 102
<i>Except for Style 920N</i> 2 x 1½-inch/ 60.3 x 48.3-mm outlets	1¾ 44	1⅞ 48	4 102
<i>Except for Style L920N</i> 10, 12, 14 x 1½-inch/ 273.0, 323.9, 355.6 x 48.3-mm outlets	2¾ 70	2⅞ 73	4 102
All 2-inch/ 60.3-mm outlets	2½ 64	2⅝ 67	4½ 114
<i>Except for Style 920 and</i> <i>L920N</i> 8 x 2-inch/ 219.1 x 60.3-mm outlets	2¾ 70	2⅞ 73	4½ 114
All 2½-inch/ 73.0-mm outlets	2¾ 70	2⅞ 73	5 127
All 76.1-mm outlets	2¾ 70	2⅞ 73	5½ 140
All 3-inch/ 88.9-mm outlets	3½ 89	3⅝ 92	5½ 140
All 4-inch/ 114.3-mm outlets	4½ 114	4⅝ 118	6½ 165
All 108.0-mm outlets	4½ 114	4⅝ 118	6½ 165

## Installation

### CAUTION

- Verify that pipe is prepared properly in accordance with the instructions on page 259.

Failure to prepare pipe according to these instructions could cause improper gasket sealing, resulting in leakage and property damage.



**1. ASSEMBLE HOUSINGS:** Insert a bolt into the two housings. Thread a nut loosely onto the bolt (nut should be flush with end of bolt).

**FOR THREE-SEGMENT STYLE L920N ASSEMBLIES (14 – 16-INCH/DN350 – DN400 SIZES):** Assemble the segments loosely (nuts should be threaded no further than flush with the end of the bolts), leaving one bolt and nut off to allow for the lower housings to be rotated around the pipe.

Style 920 Gasket

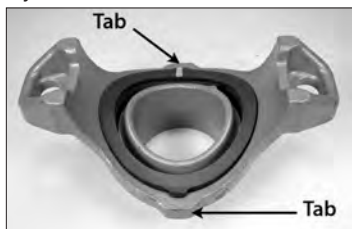

Style 920N/L920N Gasket



**2. CHECK GASKET:** Check the gasket to verify that it is suitable for the intended service. The color code identifies the material grade. Refer to page 32 for the “Gasket Color Code Reference” table. For complete compatibility information, reference Victaulic publications 05.01 and GSG-100, which can be downloaded at [victaulic.com](http://victaulic.com). Inspect the sealing surface of the gasket to verify that no debris is present.

**GASKETS FOR THE STYLE 920 ARE NOT INTERCHANGEABLE WITH GASKETS FOR THE STYLE 920N/L920N. THE CORRECT GASKET IS SHIPPED WITH THE APPROPRIATE PRODUCT.** Style 920 gaskets have a narrower gasket sealing area and two pronounced alignment tabs for proper positioning inside the housing. Style 920N/L920N gaskets have a wider gasket sealing area. Refer to the photos above for differences between the gaskets.

**! CAUTION**

- DO NOT REMOVE THE GASKET FROM THE UPPER (OUTLET) HOUSING.
- A thin coat of a compatible lubricant shall be applied ONLY to the exposed sealing surface of the gasket to help prevent the gasket from pinching, rolling, or tearing during installation.
- DO NOT use excessive lubricant on the exposed sealing surface of the gasket.
- When using the Style 920 or 920N with HDPE pipe, always consult the pipe manufacturer for lubricant compatibility requirements.

Failure to use a compatible lubricant may cause gasket damage, resulting in joint leakage and property damage.

**3. LUBRICATE GASKET:** DO NOT REMOVE THE GASKET FROM THE UPPER (OUTLET) HOUSING. Apply a thin coat of a compatible lubricant ONLY to the exposed sealing surface of the gasket. Refer to the “Lubricant Compatibility for Gaskets” table on page 34. When using the Style 920 or 920N with HDPE pipe, always consult the pipe manufacturer for lubricant compatibility requirements.



**4. INSTALL HOUSINGS:** Rotate the lower housing so that it is positioned approximately 90° to the upper (outlet) housing, as shown above. The upper (outlet) housing's locating collar shall be placed into the outlet hole. Rotate the lower housing around the pipe.



#### 5. VERIFY LOCATING COLLAR ENGAGEMENT:

Verify that the locating collar engages the outlet hole properly. Check this engagement by rocking the upper (outlet) housing in the outlet hole.

**NOTE:** The upper (outlet) housing shall be flush to the pipe OD and must not be able to rotate.



#### 6. INSTALL REMAINING BOLT/NUT:

Install the remaining bolt, and thread a nut finger-tight onto the bolt. **NOTE:** Verify that the oval neck of each bolt seats properly in the bolt hole.

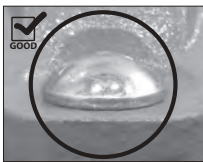

OVAL NECK OF BOLT  
SEATED PROPERLY



OVAL NECK OF BOLT  
NOT SEATED PROPERLY

### ! WARNING

- Nuts shall be tightened evenly by alternating sides, maintaining nearly uniform bolt pad gaps, until all assembly requirements specified in steps 7 – 7c are achieved.
- Keep hands away from housing openings during tightening.

Failure to tighten nuts as instructed will cause increased loading of the hardware, resulting in the following conditions:

- Excessive bolt torque required to assemble the joint (incomplete assembly)
- Damage to the assembled joint (damaged or broken bolt pads or fractures to housings)
- Bolt damage or fracture
- Joint leakage and property damage
- A negative impact on system integrity
- Personal injury or death

**DO NOT** continue to tighten the nuts after the assembly requirements specified in step 7 and step 7a, 7b, or 7c are achieved.

- Failure to follow this instruction could result in the conditions listed above.

### NOTICE

- It is important to tighten the nuts evenly by alternating sides to prevent gasket pinching.
- An impact tool or standard socket wrench with a deep-well socket can be used to tighten the hardware.
- For the 159.0-mm size, a box-end wrench **SHALL NOT** be used for installation. Box-end wrenches do not allow for full engagement of the nut during tightening.
- Refer to the “Impact Tool Usage Guidelines,” “Impact Tool Selection,” and “Torque Wrench Selection” sections in this handbook. In addition, refer to the applicable “Helpful Information” table on page 264.



**7. TIGHTEN NUTS:** Verify that the locating collar is still positioned properly in the outlet hole. Using an impact tool or a standard socket wrench with a deep-well socket, tighten the nuts evenly by alternating sides, maintaining nearly uniform bolt pad gaps, until the upper (outlet) housing contacts the pipe completely. Verify that the oval neck of each bolt seats properly in the bolt holes.

To complete the assembly, apply torque to each nut with a torque wrench, as instructed in step 7a, 7b, or 7c below. Refer to the applicable “Helpful Information” table on the following page and the “Torque Wrench Selection” section in this handbook.

**7a. FOR ALL SIZES OF STYLE 920/920N AND 2 – 12-INCH/DN50 – DN300 STYLE L920N INSTALLED ON METAL PIPE:** The nuts shall be torqued to 50 ft-lbs/68 N•m with even gaps between the bolt pads. **DO NOT** exceed 70 ft-lbs/95 N•m of torque on the nuts.

**7b. FOR 14 – 16-INCH/DN350 – DN400 STYLE L920N INSTALLED ON METAL PIPE:** The nuts shall be torqued to 100 ft-lbs/136 N•m with even gaps between the bolt pads.

**7c. FOR ALL SIZES OF STYLE 920 AND 920N HDPE PIPE:** The nuts shall be torqued to 50 ft-lbs/68 N•m. **NOTE:** When the Style 920 or 920N is used on HDPE pipe, it is normal for the bolt pads to make metal-to-metal contact when the nuts are tightened to 50 ft-lbs/68 N•m. **DO NOT** exceed 70 ft-lbs/95 N•m of torque on the nuts.

If you suspect that any hardware has been over-tightened (as indicated by a bend in the bolt, bulging of the nut at the bolt pad interface, or damage to the bolt pad, etc.), the entire outlet assembly shall be replaced immediately.

## NOTICE

- For grooved outlets, refer to the applicable coupling installation instructions.
- For threaded outlets, complete the assembly using standard threading practices.

## BRANCH CONNECTIONS

If a branch connection is made to the upper (outlet) housing before the *Mechanical-T* is installed on the pipe, verify that the branch connection is 90° to the pipe run before completing the tightening sequence of the *Mechanical-T* assembly.

- When the *Mechanical-T* is used as part of a connection between two parallel runs, it shall be assembled onto the runs before the branch connection is made.

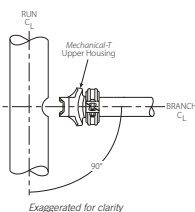

## STYLE 920 OR 920N/L920N CROSS ASSEMBLIES

- Cross assemblies can be made **ON METAL PIPE ONLY** by using two upper (outlet) housings of the same size and style. Different branch sizes are allowable.
- **DO NOT** mix Style 920 upper (outlet) housings with Style 920N/L920N upper (outlet) housings when making cross assemblies.
- **DO NOT** make cross assemblies on HDPE pipe.
- The Style L920N in 14 – 16-inch/DN350 – DN400 sizes cannot be installed as a cross assembly.
- Install the cross assembly in accordance with the instructions in this section. Verify that the locating collar on each side is positioned securely inside the outlet hole. Tighten the nuts evenly, maintaining nearly uniform bolt pad gaps, until the two upper (outlet) housings contact the pipe completely. Refer to step 7a on this page for torque requirements.



## Style 920 Helpful Information

Nominal Pipe Size inches/DN	Actual Pipe Outside Diameter inches/mm	Nut Size inches/ Metric	Deep-Well Socket Size inches/ mm
DN65	3.000 76.1	½ M12	⅞ 22
	4.250 108.0	½ M12	⅞ 22
4 DN100	4.500 114.3	½ M12	⅞ 22
	5.250 133.0	⅝ M16	1 ⅙ 27
DN125	5.500 139.7	⅝ M16	1 ⅙ 27
5	5.563 141.3	⅝ M16	1 ⅙ 27
6 DN150	6.625 168.3	⅝ M16	1 ⅙ 27
	6.250 159.0	⅝ M16	1 ⅙ 27
	6.500 165.1	⅝ M16	1 ⅙ 27
#	8.515 216.3	¾ M20	1 ¼ 32
8 DN200	8.625 219.1	¾ M20	1 ¼ 32

# Applies to JIS metric pipe size 200A (JIS Specification G 3452; G 3454).







## Style 920N Helpful Information

Nominal Pipe Size inches/DN	Actual Pipe Outside Diameter inches/mm	Nut Size inches/ Metric	Deep-Well Socket Size inches/ mm
2 – 6 DN50 – DN150	2.375 – 6.625 60.3 – 168.3	½ M12	⅞ 22
DN65 – DN125	3.000 – 5.500 76.1 – 139.7	½ M12	⅞ 22
	6.250 159.0	⅝ M16	1 ⅙ 27
	6.500 165.1	½ M12	⅞ 22

## Style L920N Helpful Information

Nominal Pipe Size inches/DN	Actual Pipe Outside Diameter inches/mm	Nut Size inches/ Metric	Deep-Well Socket Size inches/ mm
2 – 6 DN50 – DN150	2.375 – 6.625 60.3 – 168.3	½ M12	⅞ 22
8 – 16 DN200 – DN400	8.625 – 16.000 219.1 – 406.4	¾ 20	1 ¼ 32



 <b>WARNING</b>				
				
<ul style="list-style-type: none"> <li>• Read and understand all instructions before attempting to install any Victaulic products.</li> <li>• Always verify that the piping system has been completely depressurized and drained immediately prior to installation, removal, adjustment, or maintenance of any Victaulic products.</li> <li>• Confirm that any equipment, branch lines, or sections of piping that may have been isolated for/during testing or due to valve closures/positioning are identified, depressurized, and drained immediately prior to installation, removal, adjustment, or maintenance of any Victaulic products.</li> <li>• Wear safety glasses, hardhat, and foot protection.</li> <li>• The Style 922 FireLock™ Outlet-T shall be used only in fire protection systems that are designed and installed in accordance with current, applicable National Fire Protection Association (NFPA 13, 13D, 13R, etc.) standards, or equivalent standards, and in accordance with applicable building and fire codes. These standards and codes contain important information regarding protection of systems from freezing temperatures, corrosion, mechanical damage, etc.</li> <li>• These installation instructions are intended for an experienced, trained installer. The installer shall understand the use of this product and why it was specified for the particular application.</li> <li>• The installer shall understand common industry safety standards and potential consequences of improper product installation.</li> </ul> <p><b>Failure to follow installation requirements and local and national codes and standards could compromise system integrity or cause system failure, resulting in death or serious personal injury and property damage.</b></p>				

The Style 922 FireLock™ Outlet-T is designed for direct connection of sprinklers, drop nipples, sprigs, gauges, drains, and other outlet products. For complete listings and approvals, refer to Victaulic publications 10.52 and 10.54, which can be downloaded at [victaulic.com](http://victaulic.com).

The female threads of the Style 922 accommodate standard NPT or BSPT (optional) male pipe threads only. Use of male threaded products with special features, such as probes, dry pendent sprinkler heads, etc., shall be verified as suitable for use with this Victaulic product. Failure to verify suitability in advance may result in assembly issues or leakage, which can compromise system integrity and/or cause property damage.

In addition, the Style 922 is available with a 1-inch/DN25 Victaulic IGS grooved outlet for connection to Victaulic IGS grooved products.

## Pipe Preparation

### **! WARNING**

- When cutting an outlet hole for the Style 922, **DO NOT** cut over a previously welded joint. The outlet hole shall be cut in a location that has not previously been altered or repaired.

Failure to follow these instructions could cause assembly failure, resulting in death or serious personal injury and property damage.

### **NOTICE**

- Victaulic hole cutting tools are recommended for proper outlet hole preparation.
- Always verify that coupons have been removed from the pipe after the outlet hole cutting process is complete.
- Contact Victaulic for use on pipe materials other than carbon steel.

1. The first step in the installation process is preparation of the pipe. Proper pipe preparation is required for sealing and performance.
2. Pipe shall be supported during the outlet hole cutting process. Place a mark on the pipe at the specified outlet hole location.
3. Verify that the correct hole saw is being used to cut the proper sized outlet hole at the specified location on the pipe. Refer to the "Pipe Preparation Dimensions" table below.
4. The outlet hole shall be drilled on center and perpendicular to the centerline of the pipe. Improperly cut outlet holes may prevent complete insertion of the locating collar and may prevent the product from sealing on the pipe surface.
5. Remove any burrs and sharp edges from the outlet hole. Leftover burrs or sharp edges could affect engagement of the locating collar, flow from the outlet, or sealing of the gasket.
6. Verify that the pipe surface within  $\frac{1}{2}$  inch/13 mm of the outlet hole is clean, smooth, and generally free from indentations and/or projections that could affect gasket sealing. The pipe around the entire circumference within the "A" dimension shall be generally free from any dirt, scratches, abrasions, or projections that may prevent the housing from seating fully on the pipe. Refer to the drawing to the right.

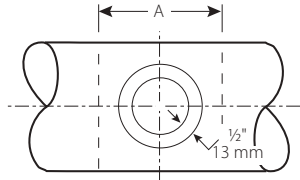

### Pipe Preparation Dimensions

	Minimum Outlet Hole Diameter/ Hole Saw Size inches/mm	Maximum Allowable Outlet Hole Diameter inches/mm	Surface Preparation "A" Dimension inches/mm
All Outlet Sizes	$1\frac{3}{16}$ 30	$1\frac{1}{4}$ 32	3 76

## Installation

### CAUTION

- Verify that pipe is prepared properly in accordance with the instructions on the previous page.

Failure to prepare pipe according to these instructions could cause improper gasket sealing, resulting in leakage and property damage.

**1a. CHECK GASKET:** Check the gasket to verify that it is suitable for the intended service. The color code identifies the material grade. Refer to page 32 for the “Gasket Color Code Reference” table. For complete compatibility information, reference Victaulic publications 05.01 and GSG-100, which can be downloaded at [victaulic.com](http://victaulic.com).



**1b. INSTALL GASKET:** Inspect the gasket and the gasket pocket to verify that no debris is present. Install the gasket into the gasket pocket, as shown. Press the gasket along the full circumference to ensure that it seats fully in the gasket pocket. **DO NOT LUBRICATE THE GASKET.**

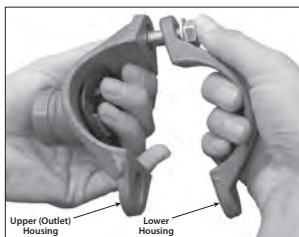

**2. ASSEMBLE HOUSINGS:** Remove the flange nut and bolt from one side of the Style 922 assembly. Thread the remaining flange nut loosely onto the bolt (flange nut should be flush with end of bolt) to allow for the “swing-over” feature.



**3a. INSTALL HOUSINGS:** Install the upper (outlet) housing onto the pipe by centering the locating collar in the outlet hole. To check for proper engagement, slide the upper (outlet) housing back and forth while pushing down. A properly positioned upper (outlet) housing will not be able to rotate around the pipe.

**3b.** While holding the upper (outlet) housing in place, rotate the lower housing around the pipe. Verify that the locating collar remains seated in the outlet hole.



#### 4. INSTALL REMAINING BOLT/FLANGE NUT:

Insert the remaining bolt through the upper (outlet) housing and lower housing. Thread a flange nut onto the bolt. **NOTE:** Verify that the oval neck of each bolt seats properly in the bolt hole.

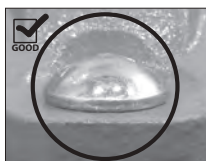

OVAL NECK OF BOLT  
SEATED PROPERLY



OVAL NECK OF BOLT  
NOT SEATED PROPERLY

### **!** WARNING

- Flange nuts shall be tightened evenly by alternating sides, maintaining nearly uniform bolt pad gaps, until all assembly requirements specified in steps 5 – 6 are achieved.
- Keep hands away from housing openings during tightening.

Failure to tighten flange nuts as instructed will cause increased loading of the hardware, resulting in the following conditions:

- Excessive bolt torque required to assemble the joint (incomplete assembly)
- Damage to the assembled joint (damaged or broken bolt pads or fractures to housings)
- Over-compression of the gasket
- Bolt damage or fracture
- Joint leakage and property damage
- A negative impact on system integrity
- Personal injury or death

**DO NOT** continue to tighten the flange nuts after the assembly requirements specified in steps 5 – 6 are achieved.

- Failure to follow this instruction could result in the conditions listed above.

### NOTICE

- It is important to tighten the flange nuts evenly by alternating sides to prevent gasket pinching.
- To avoid over-tightening the flange nuts, use a wrench with a maximum length of 8 inches/200 mm.
- Use of an impact tool with this product is discouraged, due to the lower torque required for assembly.



**5. TIGHTEN FLANGE NUTS:** Verify that the locating collar is still positioned properly in the outlet hole. Tighten the flange nuts evenly by alternating sides, maintaining nearly uniform bolt pad gaps, to a maximum torque value listed below to ensure proper gasket compression. Verify that the oval neck of each bolt seats properly in the bolt holes. Refer to the “Helpful Information” table below.

**For threaded outlets:** Tighten the flange nuts to a torque value of 20 ft-lbs/27 N•m maximum.

**For grooved outlets:** Tighten the flange nuts to a torque value of 35 ft-lbs/48 N•m maximum.

If you suspect that any hardware has been over-tightened (as indicated by a bend in the bolt, bulging of the nut at the bolt pad interface, or damage to the bolt pad, etc.), the entire outlet assembly shall be replaced immediately.

### Helpful Information

	Nut Size inches/Metric	Socket Size inches/mm
All Sizes	$\frac{3}{8}$ M10	$\frac{9}{16}$ 15

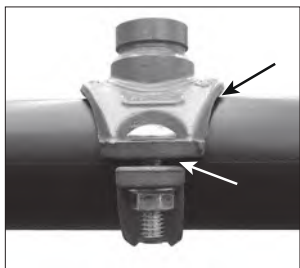

**6. INSPECT THE ASSEMBLY:** When the Style 922 is assembled correctly, the upper (outlet) housing, near the gasket, will not make metal-to-metal contact with the pipe. If there are gaps between the upper (outlet) housing's and lower housing's bolt pads, they shall be equal on both sides of the assembly.

Style 923 - Strapless Outlet

Style 924 - Strapless Thermometer Outlet

**! WARNING**



- Read and understand all instructions before attempting to install any Victaulic products.
- Always verify that the piping system has been completely depressurized and drained immediately prior to installation, removal, adjustment, or maintenance of any Victaulic products.
- Confirm that any equipment, branch lines, or sections of piping that may have been isolated for/during testing or due to valve closures/positioning are identified, depressurized, and drained immediately prior to installation, removal, adjustment, or maintenance of any Victaulic products.
- Wear safety glasses, hardhat, and foot protection.
- When the Style 923 is used in fire protection applications, the system shall be designed and installed in accordance with current, applicable National Fire Protection Association (NFPA 13, 13D, 13R, etc.) standards, or equivalent standards, and in accordance with applicable building and fire codes. These standards and codes contain important information regarding protection of systems from freezing temperatures, corrosion, mechanical damage, etc.
- These installation instructions are intended for an experienced, trained installer. The installer shall understand the use of this product and why it was specified for the particular application.
- The installer shall understand common industry safety standards and potential consequences of improper product installation.

Failure to follow installation requirements and local and national codes and standards could compromise system integrity or cause system failure, resulting in death or serious personal injury and property damage.

- The female threads of the Style 923 accommodate NPT (standard), BSPT (optional), or BSPP (optional) male pipe threads only. Use of male threaded products with special features, such as probes, dry pendent sprinkler heads, etc., shall be verified as suitable for use with this Victaulic product. Failure to verify suitability in advance may result in assembly issues or leakage, which can compromise system integrity and/or cause property damage. For complete listings and approvals for the Style 923, refer to Victaulic publication 11.05, which can be downloaded at victaulic.com.

- **When the Style 923 is ordered with the BSPP thread option, a BSPT male x BSPP female threaded bushing is supplied:**  
To create a pressure-tight seal per ISO 228-1, an appropriate seal (such as a bonded seal ring or an o-ring with retaining ring) shall be installed between the two mating surfaces outboard of the threads. **NOTE:** Victaulic does not supply the bonded seal ring or o-ring with retaining ring.

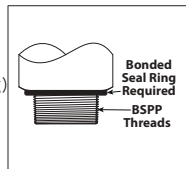

- Victaulic Style 924 Strapless Thermometer Outlets contain UNEF (standard), NPT (optional), or BSPP (optional) branch connection threads to receive industrial thermometers with a 6-inch/152-mm nominal stem length. Use of an industrial thermometer with a stem length shorter than 6 inches/152 mm may result in inaccurate readings. The stem's diameter shall be checked to verify that it will not interfere with installation of the industrial thermometer into the Style 924. **NOTE:** Some industrial thermometers are provided with a removable thermowell; this thermowell shall be removed before installing the industrial thermometer into the Style 924. Always refer to the industrial thermometer manufacturer's literature for complete information. For complete listings and approvals for the Style 924, refer to Victaulic publication 11.06, which can be downloaded at victaulic.com.

## Pipe Preparation

### **WARNING**

- When cutting an outlet hole for the Style 923 or 924, **DO NOT** cut over a previously welded joint. The outlet hole shall be cut in a location that has not previously been altered or repaired.

Failure to follow these instructions could cause assembly failure, resulting in death or serious personal injury and property damage.

### **NOTICE**

- Victaulic hole cutting tools are recommended for proper outlet hole preparation.
- Always verify that coupons have been removed from the pipe after the outlet hole cutting process is complete.

1. The first step in the installation process is preparation of the pipe. Proper pipe preparation is required for sealing and performance.
2. Pipe shall be supported during the outlet hole cutting process. Place a mark on the pipe at the specified outlet hole location.
3. Verify that the correct hole saw is being used to cut the proper sized outlet hole at the specified location on the pipe. Refer to the "Pipe Preparation Dimensions" table below.
4. The outlet hole shall be drilled on center and perpendicular to the centerline of the pipe. Improperly cut outlet holes may prevent complete insertion of the locating collar and may prevent the product from sealing on the pipe surface.
5. Remove any burrs and sharp edges from the outlet hole. Leftover burrs or sharp edges could affect engagement of the Style 923 or 924, flow from the outlet, or sealing of the gasket.
6. Verify that the pipe surface within  $\frac{5}{8}$  inch/16 mm of the outlet hole is clean, smooth, and generally free from indentations and/or projections that could affect gasket sealing. The pipe around the entire circumference within the "A" dimension shall be generally free from any dirt, scratches, abrasions, or projections that may prevent the Style 923 or 924 from seating fully on the pipe. Refer to the drawing to the right.

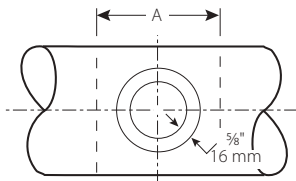

### Pipe Preparation Dimensions

	Minimum Outlet Hole Diameter/ Hole Saw Size inches/mm	Maximum Allowable Outlet Hole Diameter inches/mm	Surface Preparation "A" Dimension inches/mm
All Outlet Sizes	1 1/2 38	1 1/16 40	3 1/2 89

## Installation

### CAUTION

- Verify that pipe is prepared properly in accordance with the instructions on the previous page.  
Failure to prepare pipe according to these instructions could cause improper gasket sealing, resulting in leakage and property damage.

### NOTICE

- The images in this section show installation of a Style 923 Strapless Outlet; however, the same steps apply to installation of a Style 924 Strapless Thermometer Outlet.

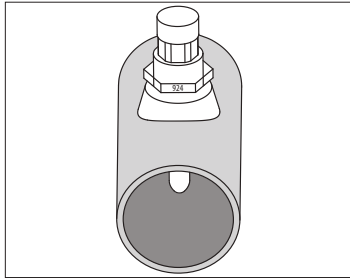

**1. CHECK THE STYLE 923 OR 924:** Verify that the “923” or “924” marking on the top hex nut is facing toward the curvature of the collar (along pipe axis), as shown above.

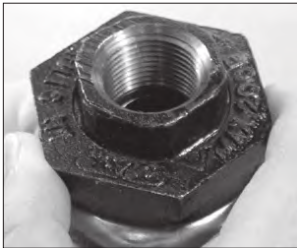

**2. POSITION ASSEMBLY NUT:** Position the lettered face of the assembly nut at the top of the threads, as shown above. DO NOT remove the assembly nut.

**3a. CHECK GASKET:** Check the gasket to verify that it is suitable for the intended service. The color code identifies the material grade. Refer to page 32 for the “Gasket Color Code Reference” table. For complete compatibility information, reference Victaulic publications 05.01 and GSG-100, which can be downloaded at [victaulic.com](http://victaulic.com). Inspect the sealing surface of the gasket to verify that no debris is present.

### CAUTION

- DO NOT REMOVE THE GASKET FROM THE STYLE 923 OR 924.
- A thin coat of a compatible lubricant shall be applied ONLY to the exposed sealing surface of the gasket to help prevent the gasket from pinching, rolling, or tearing during installation.
- DO NOT use excessive lubricant on the exposed sealing surface of the gasket. Failure to use a compatible lubricant may cause gasket damage, resulting in joint leakage and property damage.



**3b. LUBRICATE GASKET:** DO NOT REMOVE THE GASKET FROM THE STYLE 923 OR 924. Apply a thin coat of a compatible lubricant ONLY to the exposed sealing surface of the gasket. Refer to the “Lubricant Compatibility for Gaskets” table on page 34.

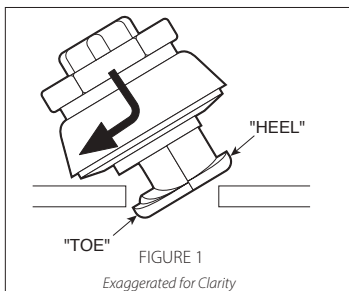

**4. INSERT STYLE 923 OR 924:** Align the “foot” of the Style 923 or 924 with the pipe. Tilt the “toe” into the outlet hole to insert the Style 923 or 924 (refer to Figure 1 above).

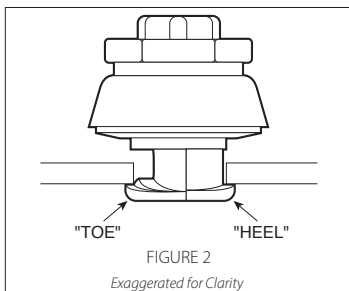

**5. POSITION STYLE 923 OR 924:** Shift the Style 923 or 924 to position the “heel” inside the pipe. **NOTE:** The heel shall be positioned, as shown in Figure 2 above, to ensure proper performance under operating conditions.

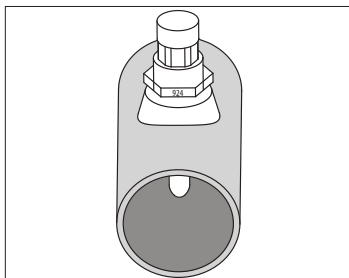

**6. HAND-TIGHTEN ASSEMBLY NUT:** While holding the collar in position, hand-tighten the assembly nut. Check for proper positioning after tightening by attempting to tilt the Style 923 or 924 in the outlet hole. The Style 923 or 924 should not shift. If shifting occurs, loosen the assembly nut, re-position the Style 923 or 924, and then hand-tighten the assembly nut again. **NOTE:** Verify that the “923” or “924” marking on the top hex nut is still facing toward the curvature of the collar (along pipe axis), as shown above.



**7. WRENCH-TIGHTEN ASSEMBLY NUT:** Wrench-tighten the assembly nut until the collar deforms and contacts the pipe evenly on all sides. Maintain collar/gasket alignment to prevent gasket pinching.

**For ½-inch/DN15 and ¾-inch/DN20 outlet sizes:**  
DO NOT exceed 200 ft-lbs/271 N•m.

**For 1-inch/DN25, 1 ¼-inch/DN32, and 1 ½-inch/DN40 outlet sizes:**  
DO NOT exceed 380 ft-lbs/515 N•m.

**NOTE:** For 4 – 8-inch/DN100 – DN200 Style 923 and 924 sizes, a “ratcheting” motion during tightening will assist in maintaining alignment with the collar.

## **! WARNING**

- The collar shall deform to contact the pipe evenly on all sides.
  - For ½-inch/DN15 and ¾-inch/DN20 outlet sizes: **DO NOT** exceed 200ft-lbs/ 271 N•m of torque on the assembly nut during installation.
  - For 1-inch/DN25, 1 ¼-inch/DN32, and 1 ½-inch/DN40 outlet sizes: **DO NOT** exceed 380ft-lbs/515 N•m of torque on the assembly nut during installation.
  - **DO NOT** exceed 1 ½ times the working pressure during system tests.
- Failure to follow these instructions could cause joint failure, resulting in death or serious personal injury and property damage.







**8. INSPECT THE ASSEMBLY:** After wrench-tightening the assembly nut, verify that the curvature of the collar conforms to the curvature of the pipe. In addition, verify that the collar contacts the pipe evenly on all sides and that no portion of the gasket is exposed.



**9. MAKE CONNECTION:** Make the required connection by using a second wrench on the top hex only. To prevent loosening of the outlet in the outlet hole, **DO NOT** use the assembly nut for tightening this connection.

## **NOTICE**

- Due to deformation of the collar, the Style 923 and 924 **SHALL NOT** be reused after initial installation.

 <b>WARNING</b>				
				
<ul style="list-style-type: none"> <li>• Read and understand all instructions before attempting to install any Victaulic products.</li> <li>• Always verify that the piping system has been completely depressurized and drained immediately prior to installation, removal, adjustment, or maintenance of any Victaulic products.</li> <li>• Confirm that any equipment, branch lines, or sections of piping that may have been isolated for/during testing or due to valve closures/positioning are identified, depressurized, and drained immediately prior to installation, removal, adjustment, or maintenance of any Victaulic products.</li> <li>• Wear safety glasses, hardhat, and foot protection.</li> <li>• These installation instructions are intended for an experienced, trained installer. The installer shall understand the use of this product and why it was specified for the particular application.</li> <li>• The installer shall understand common industry safety standards and potential consequences of improper product installation.</li> </ul> <p>Failure to follow installation requirements and local and national codes and standards could compromise system integrity or cause system failure, resulting in death or serious personal injury and property damage.</p>				

Style 926 Mechanical-T Spigot Outlets are designed to provide a direct branch connection to OGS grooved piping components. For additional details, reference Victaulic publication 11.07, which can be downloaded at victaulic.com.

The following procedures are for proper assembly of the Style 926 on carbon steel and ductile iron pipe. For proper assembly on HDPE pipe, reference the I-900 Field Installation Handbook, which can be downloaded at victaulic.com.

### Pipe Preparation

 <b>WARNING</b>
<ul style="list-style-type: none"> <li>• When cutting an outlet hole for the Style 926, DO NOT cut over a previously welded joint. The outlet hole shall be cut in a location that has not previously been altered or repaired.</li> </ul> <p>Failure to follow these instructions could cause assembly failure, resulting in death or serious personal injury and property damage.</p>

<b>NOTICE</b>
<ul style="list-style-type: none"> <li>• For steel pipe, a Victaulic hole cutting tool equipped with a Milwaukee Hole-Hawg® Drill 300/1200 RPM, or similar hole saw, is recommended for proper outlet hole preparation.</li> <li>• Always verify that coupons have been removed from the pipe after the outlet hole-cutting process is complete.</li> </ul>

1. The first step in the installation process is preparation of the pipe. Proper pipe preparation is required for sealing and performance.
2. Pipe shall be supported during the outlet hole cutting process. Place a mark on the pipe at the specified outlet hole location.
3. Verify that the correct hole saw is being used to cut the proper sized outlet hole at the specified location on the pipe. Refer to the "Pipe Preparation Dimensions" table on the following page.
4. The outlet hole shall be drilled on center and perpendicular to the centerline of the pipe. Improperly cut outlet holes may prevent complete insertion of the locating collar and may prevent the product from sealing on the pipe surface.

® Milwaukee Hole-Hawg is a registered trademark of Milwaukee Tool

5. Remove any burrs and sharp edges from the outlet hole. Leftover burrs or sharp edges could affect engagement of the locating collar, flow from the outlet, or sealing of the o-ring.
6. Verify that the pipe surface within  $\frac{5}{8}$  inch/ 16 mm of the outlet hole is clean, smooth, and generally free from indentations and/or projections that could affect gasket sealing. The pipe around the entire circumference within the "A" dimension shall be generally free from any dirt, scratches, abrasions, or projections that may prevent the strap or Style 926 from seating fully on the pipe. Refer to the drawing to the right.

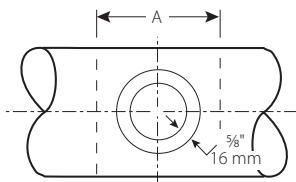

### Pipe Preparation Dimensions

Nominal Outlet Size inches/mm	Minimum Outlet Hole Diameter/ Hole Saw Size inches/mm	Maximum Allowable Outlet Hole Diameter inches/mm	Surface Preparation "A" Dimension inches/mm
4 100	4 1/2 115	4 5/8 117	8 203
6 150	6 5/8 168	6 3/4 171	10 254
8 200	8 1/4 210	8 3/8 213	12 305

## Installation



**1. INSERT CROSSBAR:** Insert a crossbar into the retaining bracket on both sides of the strap. The flat side of the crossbar shall face away from the open end of the strap, as shown in the profile view in step 3 below.



**2. INSERT U-BOLT:** Insert a U-bolt into the crossbar on both sides of the strap. The threaded ends shall protrude through the flat sides of the crossbars.



**3. LOOSELY THREAD NUTS:** Place one washer over each end of the U-bolts, then loosely thread a nut over each washer. The nuts shall only be tight enough to hold the assembly in place.

**NOTE:** Over-tightening may prevent ease of assembly when placing U-bolts over the housing.

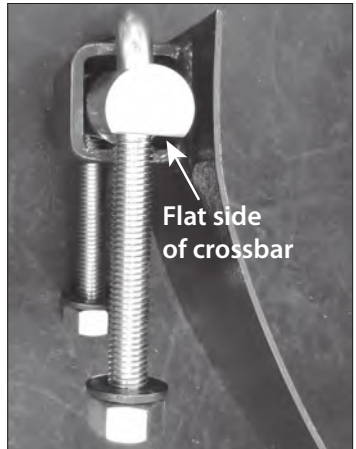

### CAUTION

- A thin coat of a compatible lubricant shall be applied **ONLY** to the groove on the underside of the Style 926 housing to help prevent the o-ring from pinching, rolling, or tearing during installation.
- **DO NOT** use excessive lubricant in the groove.
- When using the Style 926 with HDPE pipe, always consult the pipe manufacturer for lubricant compatibility requirements.

Failure to use a compatible lubricant may cause gasket damage, resulting in joint leakage and property damage.



**4. LUBRICATE GROOVE:** Apply a thin coat of a compatible lubricant **ONLY** to the o-ring groove on the underside of the Style 926 housing. Refer to the “Lubricant Compatibility for Gaskets” table on page 34. When using the Style 926 with HDPE pipe, always consult the pipe manufacturer for lubricant compatibility requirements, and reference the I-900 Field Installation Handbook.

**5a. CHECK O-RING:** Check the o-ring to verify that it is suitable for the intended service. The color code identifies the material grade. **Refer to page 32 for the “Gasket Color Code Reference” table. For complete compatibility information, reference Victaulic publications 05.01 and GSG-100, which can be downloaded at victaulic.com.** Inspect the o-ring to verify that no debris is present.



**5b. INSTALL O-RING:** Press the o-ring into the groove on the underside of the Style 926 housing. **DO NOT** place the o-ring on the pipe and then attempt to push the locating collar through it. This may push the o-ring into the outlet hole, and will prevent proper sealing.



**6. PLACE HOUSING:** Place the Style 926 housing by inserting the locating collar into the outlet hole in the pipe. Verify that the o-ring remains in the groove on the housing and does not fall into the outlet hole.



**7. PLACE STRAP:** Push one end of the strap underneath the pipe and hook one U-bolt over the retaining gusset of the Style 926 housing.



**8. ATTACH STRAP:** On the opposite side of the pipe, pull the second U-bolt up and hook it over the second retaining gusset of the Style 926 housing. **NOTE:** If there is inadequate length to perform this step, loosen the nuts on the U-bolts to lengthen the assembly.



**9. POSITION FOR TIGHTENING:** Position the U-bolts, crossbars, and strap so that a deep-well socket can fit around all nuts for tightening.

## NOTICE

- It is important to tighten the nuts on each U-bolt evenly by alternating between them.
- An impact tool or standard socket wrench with a deep-well socket can be used to tighten the hardware.
- Refer to the “Impact Tool Usage Guidelines,” “Impact Tool Selection,” and “Torque Wrench Selection” sections in this handbook.



**10. TIGHTEN HARDWARE:** Using an impact tool or a standard socket wrench with a deep-well socket, tighten both nuts on each U-bolt evenly by alternating between them. Drive one nut no more than ¼ inch/6 mm beyond the location of the second nut on a given U-bolt. **To complete the assembly, apply torque to each nut per the table below, with even spacing between the housing and the strap on both sides.**

Nominal Outlet Size inches/mm	Pipe Material	Required Torque ft-lbs/N•m	Nut Size inches/Metric	Deep-Well Socket Size inches/mm
4 – 6 100 – 150	Carbon Steel/ Ductile Iron	75 – 100 102 – 136	5/8 M16	1 1/16 27
8 200	Carbon Steel/ Ductile Iron	150 – 200 203 – 271	7/8 M22	1 7/16 36

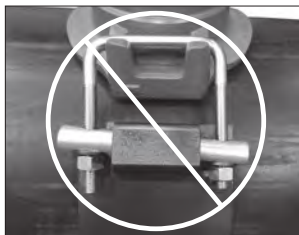

**NOTE:** Over-tightening one nut can cause damage to the threads and may cause the assembly to shift position, as shown to the left.

## ! WARNING

- **DO NOT** exceed the maximum specified torque on the nuts. Increased torque will not improve sealing and may cause product failure. Failure to torque nuts properly could cause product failure, resulting in death or serious personal injury and property damage.

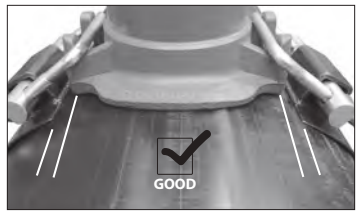
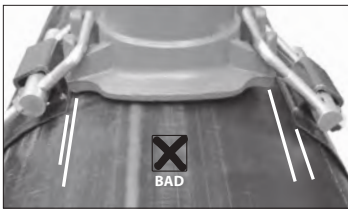

**11. INSPECT HARDWARE:** Verify that the Style 926 housing is an equal distance from the strap on each side. If the strap hardware does not grip the housing evenly from both sides, the assembly may be pulled out of alignment, causing the housing to angle into the outlet hole and creating improper compression of the o-ring.

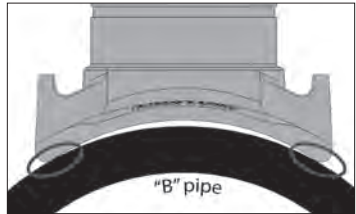
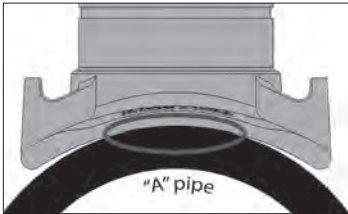

**12. INSPECT ASSEMBLY CONTACT POINTS:** The Style 926 housing shall contact the pipe at a minimum of two separate locations. First, reference the tables below to determine if the pipe size used falls under the "A" or "B" category. Second, see the illustrations above for appropriate points of contact for that category.

#### Carbon Steel Pipe

4-inch/100-mm Outlet Size	
"A" Pipe	"B" Pipe
12 inches 300 mm	10 inches 250 mm
16 inches 400 mm	14 inches 350 mm
22 inches 550 mm	18 inches 450 mm
24 inches 600 mm	20 inches 500 mm
26 inches 650 mm	28 inches 700 mm
-	30 inches 750 mm
-	32 inches 800 mm

6-inch/150-mm Outlet Size	
"A" Pipe	"B" Pipe
16 inches 400 mm	18 inches 450 mm
20 inches 500 mm	26 inches 650 mm
22 inches 550 mm	32 inches 800 mm
24 inches 600 mm	36 inches 900 mm
28 inches 700 mm	48 inches 1200 mm
30 inches 750 mm	-
42 inches 1050 mm	-

8-inch/200-mm Outlet Size	
"A" Pipe	"B" Pipe
28 inches 700 mm	32 inches 800 mm
30 inches 750 mm	-
36 inches 900 mm	-

#### Ductile Iron Pipe

4-inch/100-mm Outlet Size	
"A" Pipe	"B" Pipe
12 inches 300 mm	10 inches 250 mm
16 inches 400 mm	14 inches 350 mm
20 inches 500 mm	18 inches 450 mm
24 inches 600 mm	30 inches 750 mm

6-inch/150-mm Outlet Size	
"A" Pipe	"B" Pipe
18 inches 450 mm	16 inches 400 mm
36 inches 900 mm	20 inches 500 mm
-	24 inches 600 mm
-	30 inches 750 mm

8-inch/200-mm Outlet Size	
"A" Pipe	"B" Pipe
-	36 inches 900 mm

# End Caps and Test Cap Kit

# VICTAULIC END CAP INSTALLATION SAFETY INSTRUCTIONS

## ⚠ WARNING



- Read and understand all instructions before attempting to install, remove, adjust, or maintain the coupling/end cap, any end cap connections, and any other Victaulic piping products.
- Always depressurize and drain the piping system completely before attempting to install, remove, adjust, or maintain the coupling/end cap, any end cap connections, and any other Victaulic piping products.
- Always verify that the piping system has been completely depressurized and drained immediately prior to installation, removal, adjustment, or maintenance of the coupling/end cap, any end cap connections, and any other Victaulic piping products.
- Under no circumstances should coupling hardware or any other system component be loosened to check if the system is pressurized or to depressurize the system.
- Wear safety glasses, hardhat, and foot protection.

**Failure to follow these instructions could result in death or serious personal injury and property damage.**

This section provides safety instructions for the installation, use, and removal of Victaulic-manufactured end caps with Victaulic-manufactured couplings in all size ranges and groove profiles, along with other important information that is critical for proper use of Victaulic end caps.

For Installation-Ready™ Couplings, refer to the “NOTICE” on page 284 for important Victaulic end cap marking information.

Always verify that the Victaulic end cap being used is designed for the specific groove profile. For example, the Victaulic No. W60 End Cap shall be used only with Victaulic Advanced Groove System (AGS) products. Refer to the I-W100 Field Installation Handbook for additional information regarding AGS end caps.

When installing, using, or removing a Victaulic end cap, always reference the specific installation instructions in this handbook for the Victaulic coupling that is being used with the Victaulic end cap. For the Victaulic No. T-60 Test Caps, always refer to the additional instructions provided with the kit and that are included on page 286 of this handbook.

After installation, always inspect the assembly to verify proper installation.



**GOOD ASSEMBLY**  
(END CAP IS SEATED WITHIN THE COUPLING WITH THE CORRECT SIDE FACING OUT AND COUPLING BOLT PADS ARE IN METAL-TO-METAL CONTACT)

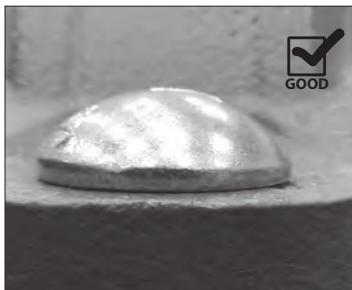

**GOOD BOLT ENGAGEMENT**  
(OVAL NECK OF EACH BOLT IS SEATED PROPERLY IN THE BOLT HOLE)

The following conditions are not acceptable and shall be corrected before any system pressure testing occurs.

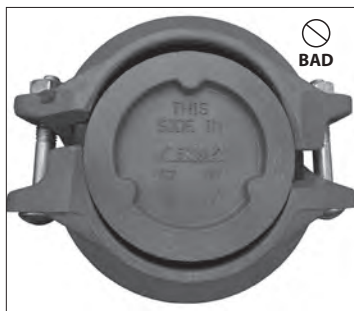

**BAD ASSEMBLY**  
(INCORRECT SIDE OF END CAP IS FACING OUT – HARDWARE WILL NOT BE ABLE TO BE TIGHTENED TO BRING THE BOLT PADS INTO METAL-TO-METAL CONTACT)

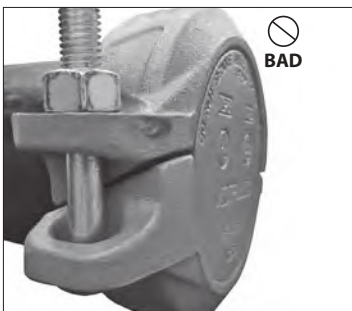

**BAD ASSEMBLY**  
(BOLT PADS ARE NOT IN METAL-TO-METAL CONTACT)



**BAD BOLT ENGAGEMENT**  
(OVAL NECK IS NOT SEATED PROPERLY IN THE BOLT HOLE)

## NOTICE

### For Installation of Victaulic End Caps with Victaulic Installation-Ready Couplings:

- Victaulic Installation-Ready couplings shall be used with specific types of Victaulic end caps. These end caps are identified by markings that are listed below. Always verify that the proper Victaulic end cap is being used.
- When assembling a Victaulic Installation-Ready coupling onto a Victaulic end cap, verify that the end cap is seated fully against the center leg of the gasket. For full installation requirements, always refer to the specific instructions in this handbook for the Victaulic coupling.

### For Victaulic Style 009N Couplings

- Use only Victaulic FireLock™ No. 006 End Caps containing the “EZ” marking on the inside face or Victaulic No. 60 End Caps containing the “EZ QV” marking on the inside face.

### For Victaulic Style 607 Couplings

- Use only Victaulic No. 660 End Caps with the “QV” marking on the inside face.

### For All Other Styles of Victaulic Installation-Ready Couplings for the Original Groove System (OGS)

- Use only Victaulic No. 60 End Caps containing the “EZ QV” marking on the inside face.

## SAFETY INSTRUCTIONS FOR NO. T-60 TEST CAPS OR END CAPS INSTALLED FOR SYSTEM PRESSURE TESTING

- Victaulic end caps that are installed for system pressure testing shall be equipped with a ball valve that can be opened to verify if the system is depressurized.
- The Victaulic No. T-60 Test Cap should be used whenever possible for purposes of system pressure testing. If a Victaulic No. T-60 Test Cap is not available in the applicable size, contact Victaulic about ordering a tapped end cap that the customer can fit with an appropriately-rated ball valve for the system conditions. **Under no circumstances should coupling hardware or any other system component be loosened to check if the system is pressurized or to depressurize the system.**
- Before system pressure testing, verify that no valves within the tested system (or portion of the system being tested) are closed in order to prevent pressure from being trapped inadvertently.
- Immediately after completing the system pressure test, the system pressure shall be relieved through an appropriate valve.

## NOTICE

- A pressure gauge alone is not an acceptable method of verifying system pressure. Always use a secondary means of verification, such as a second pressure gauge or valve, to confirm that the system is depressurized in accordance with national and local codes and standards for the jobsite.

# VICTAULIC END CAP REMOVAL SAFETY INSTRUCTIONS

## ⚠ WARNING



- **COUPLING/END CAP MAY BE PRESSURIZED.**
- Always depressurize and drain the piping system completely before attempting to install, remove, adjust, or maintain the coupling/end cap, any end cap connections, and any other Victaulic piping products.
- Always verify that the piping system has been completely depressurized and drained immediately prior to installation, removal, adjustment, or maintenance of the coupling/end cap, any end cap connections, and any other Victaulic piping products.
- Under no circumstances should coupling hardware or any other system component be loosened to check if the system is pressurized or to depressurize the system.
- Wear safety glasses, hardhat, and foot protection.

Failure to follow these instructions could result in death or serious personal injury and property damage.

1. Depressurize and drain the piping system completely, and verify that there is no residual pressure.
2. Loosen the nuts of the coupling slowly and, depending on the orientation of the coupling and end cap, be prepared to support the end cap as it releases from the coupling.

## VICTAULIC RECOMMENDS:

- Hydrostatic (water) testing instead of pneumatic (air) testing whenever possible
- Use of a tapped end cap with a pressure-relieving device at each test point location (the No. T-60 Test Cap Kit and made-to-order tapped end caps are available for order through Victaulic)
- Removal of pressure immediately after completing a test (follow all applicable national and local codes and standards for the specific jobsite)
- Lockout/tagout procedures approved by the installing contractor
- Following the testing procedures recommended by technical experts, such as those found in the "Guide to Pressure Testing Safety" published by the Mechanical Contractors Association of America, Inc. (MCAA)

# NO. T-60 TEST CAP KIT INSTALLATION AND USE INSTRUCTIONS

## **⚠ WARNING**



- **COUPLING/TEST CAP ASSEMBLY MAY BE PRESSURIZED.**

- Always depressurize and drain the piping system completely before attempting to loosen the coupling/test cap assembly.
- Use caution when opening the ball valve.
- Keep face and other body parts away from the ball valve's outlet when attempting to test the system.
- **DO NOT tamper with the ball valve. The user is responsible for verifying that the test cap assembly is not damaged and is in proper working condition prior to use.**

**Failure to follow these instructions could result in death or serious personal injury and property damage.**

1. Victaulic recommends installing this test cap assembly with a Style 107N QuickVic™ Installation-Ready™ Rigid Coupling or Style 07 Zero-Flex™ Rigid Coupling. Follow the instructions in this handbook for the applicable coupling.
2. Verify that the ball valve is in the CLOSED position before attempting to pressurize the system.
3. After testing is complete, or before attempting to adjust or remove any couplings, slowly open the ball valve to determine if the line is still pressurized. If a continuous stream of fluid or air occurs from the ball valve while it is being opened, the line **MUST** be depressurized (atmospheric pressure) and drained completely of test media contents before proceeding with removal or adjustment of any couplings.

- ⚠ **DO NOT INSTALL A PIPE PLUG IN THE OUTLET OF THE BALL VALVE.**
- ⚠ Test cap assemblies are intended only for temporary use during system testing activities and shall not be installed permanently.
- ⚠ The user is responsible for inspecting and verifying that all test cap assemblies are suitable for service prior to each use. Inspect the assembly for deformation or cracks in the test cap casting and connecting coupling. Inspect the ball valve for damage, and verify that the threaded connection to the cap is secure. Any damaged components must be replaced immediately.
- ⚠ Verify that the grooved pipe end does not contain indentations, projections, or roll marks that will interfere with proper coupling/ test cap installation. Any pipe end deformities must be corrected.
- ⚠ **The test cap assembly can be used repeatedly within the maximum rated test pressure of 250 psi/1700 kPa/17 Bar. Test pressure shall not exceed joint rating at point of attachment.**

# Valve Installation Instructions

Butterfly Valves

Check Valves

Ball Valves

Plug Valves

Gate Valves

## WARNING

- ALWAYS VERIFY THAT MATING COMPONENTS WITH THE CORRECT GROOVE PROFILE ARE BEING USED WITH THE VALVE.
- DO NOT LOOSEN OR TIGHTEN HARDWARE WHEN A VALVE IS PRESSURIZED.
- The system designer is responsible for verifying suitability of mating component materials with the intended fluid media. Valve bodies, discs, and other wetted components shall be compatible with the material flowing through the piping system. Refer to the current Victaulic product publication for the applicable valve, or contact Victaulic for details.
- The effect of chemical composition, pH level, operating temperature, chloride level, oxygen level, and flow rate on mating component materials shall be evaluated to confirm system life will be acceptable for the intended service.

Failure to follow these instructions will cause improper assembly and joint failure, resulting in death or serious personal injury and property damage.

# BUTTERFLY VALVES

## NOTICE

- To prevent Victaulic Butterfly Valves from rotating in the system, Victaulic recommends installing the valve with at least one Victaulic Rigid Coupling. If two Victaulic Flexible Couplings are used, additional support may be required to eliminate joint deflection or valve rotation at the coupling connection to the piping system.

- When installing a Victaulic Butterfly Valve into the piping system, follow the instructions in this handbook for the applicable coupling (refer to the following page for additional installation notes). **Victaulic Butterfly Valves can be installed in either the horizontal or vertical orientations.**



**DO NOT INSTALL BUTTERFLY VALVES INTO THE SYSTEM WITH THE DISC IN THE FULLY-OPEN POSITION. Exposed disc may be damaged and prevent proper function of the valve.**

**Verify that no part of the disc protrudes beyond the end of the valve body.**

- When using Victaulic Butterfly Valves for throttling service, Victaulic recommends positioning the disc no less than 30 degrees open. For best results, the disc should be between 30 and 70 degrees open; this is dependent on the flow requirements/ characteristics for the piping system. High pipeline velocities and/ or throttling with the disc less than 30 degrees open may result in noise, vibration, cavitation, severe gasket erosion/abrasion, and/or loss of control. Contact Victaulic regarding throttling services.
- Victaulic recommends limiting the flow velocities for water service to 20 feet per second/6 meters per second. Contact Victaulic before installing a butterfly valve when higher flow velocities are necessary or specified. When dealing with flow media other than water, contact Victaulic.
- Victaulic recommends good piping practices by installing the butterfly valve five pipe diameters downstream of sources of irregular flow, such as pumps, elbows, and control valves. If not practical due to space constraints, the system should be designed to locate and orient the valve to minimize the impact of dynamic torque on valve life.
- Victaulic Butterfly Valves and connected piping shall be supported properly to prevent the joints from being overloaded. Hanger spacing shall comply with the applicable "Rigid System Hanger Spacing" section of this handbook.
- DO NOT use a Victaulic Butterfly Valve as a support for the piping system.
- Welding to Victaulic Butterfly Valves is not permitted and will void the Victaulic warranty.
- When directly connecting a Victaulic End Cap to a Victaulic Butterfly Valve, use only a tapped end cap with a ball valve that can be opened to verify if the system is depressurized. If the butterfly valve is opened and then closed unknowingly while the end cap is attached, the space between the disc and end cap will be filled and pressurized. A sudden release of energy can occur if the end cap is removed while the space behind it is pressurized. **PRESSURE SHALL BE VENTED THROUGH THE END CAP'S BALL VALVE BEFORE ATTEMPTING TO REMOVE THE CAP. NOTE: Due to disc clearance dimensions, an end cap directly connected to a Butterfly Valve may prevent the disc from reaching the fully "OPEN" position.**

## **! DANGER**



- When directly connecting a Victaulic End Cap to a Victaulic Butterfly Valve, use only a tapped end cap with a ball valve that can be opened to verify if the system is depressurized.
  - Pressure shall be vented through the end cap's ball valve before attempting to remove the cap.
- Failure to follow these instructions could result in death or serious personal injury and property damage.

### **Series 461 Vic-300™ MasterSeal™ Stainless Steel Butterfly Valve**

- Series 461 Butterfly Valves CANNOT be connected directly to flanged components with Style 743 *Vic-Flange* Adapters. A No. 46 ANSI 300 groove-by-flange adapter is required for this application.

### **Series 700 Butterfly Valve**

- Style 741/841 *Vic-Flange* Adapters can be used ONLY on one side of Series 700 Butterfly Valves that will not interfere with mating components and handle operation.
- Style HP-70ES Couplings SHALL NOT be used for installation of Series 700 Butterfly Valves.

### **Series 705, 707C, 765, and 766 Butterfly Valves**

- Style 741/841 *Vic-Flange* Adapters can be used ONLY on one side of 8-inch/DN200 and smaller Series 705, 707C, 765, and 766 Butterfly Valves that will not interfere with mating components and handle operation.
- Style 741/841 *Vic-Flange* Adapters CANNOT be used on 10 – 12-inch/DN250 – DN300 Series 705W Butterfly Valves.
- Series 705, 707C, 765, and 766 Butterfly Valves CANNOT be connected directly to flanged components with Style 743 *Vic-Flange* Adapters. A No. 46 ANSI 300 groove-by-flange adapter is required for this application.

### **Series 761 Vic-300™ MasterSeal™ Butterfly Valve**

- Style 741/841 *Vic-Flange* Adapters CAN be used on all sizes of Series 761 Butterfly Valves.
- Series 761 Butterfly Valves CANNOT be connected directly to flanged components with Style 743 *Vic-Flange* Adapters. A No. 46 ANSI 300 groove-by-flange adapter is required for this application.

### **Series W761 AGS Vic-300™ MasterSeal™ Butterfly Valve**

#### **Series W719 AGS Butterfly Valve**

- AGS Butterfly Valves CAN be connected directly to flanged components with Style W741 AGS *Vic-Flange* Adapters.
- Refer to the “Check Valve Installation Instructions” in this section for additional requirements.

# ADJUSTING THE TRAVEL LIMIT STOPS FOR VIC-300™ MASTERSEAL™ BUTTERFLY VALVES WITH GEAR OPERATORS

- Adjustment of the travel limit stops can be performed while the system is operational.  
**NOTE:** Cycling of the valve to test travel limit stop adjustments may affect downstream equipment. Refer to the instructions on this and the following pages for detailed instructions on how to adjust the travel limit stops.

## Adjusting and Setting the “SHUT” Travel Limit Stops of the Gear Operator



1. Remove the dust cap from the right side of the gear operator.



**2a.** Loosen the hex lock nut (counterclockwise) located on the right side of the gear operator.

**2b.** Using a hex key wrench, loosen the internal set screw approximately three turns (counterclockwise).



### NOTICE

- When using a stem extension kit, additional adjustment may be required to achieve the fully “SHUT” position.
- System pressure upstream of the valve may increase while the valve disc is in the fully “SHUT” position.
- Flow downstream of the valve will be interrupted with the disc in the fully “SHUT” position.

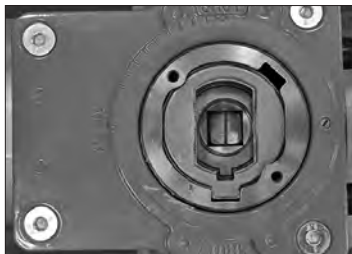

3. Verify that the valve is in the fully “SHUT” position. The fully “SHUT” position can be verified by removing the indicator cap from the top of the gear operator and checking the position indicator on top of the stem, as shown to the left.



- 4a.** Using a hex key wrench, tighten the internal set screw (clockwise) until it contacts the internal quadrant gear.
- 4b.** While holding the internal set screw in position with the hex key wrench, tighten the hex lock nut (clockwise).
- 5.** Verify proper operation of the gear operator by turning the handwheel. Repeat the prior steps of this procedure, if necessary.
- 6.** Replace the dust cap, and follow the “OPEN” travel limit stop adjustment procedure on the following page.

## Adjusting and Setting the “OPEN” Travel Limit Stops of the Gear Operator



**1.** Remove the dust cap from the left side of the gear operator.

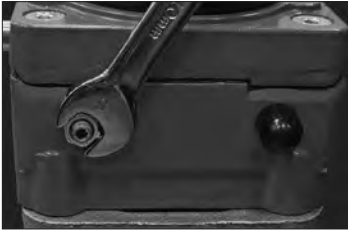

**2a.** Loosen the hex lock nut (counterclockwise) located on the left side of the gear operator.



**2b.** Using a hex key wrench, loosen the internal set screw approximately three turns (counterclockwise).

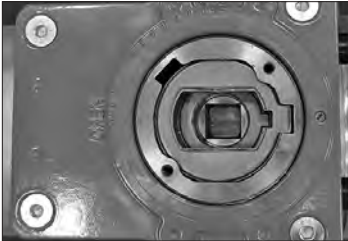

**3.** Turn the handwheel counter-clockwise. Verify that the valve is in the fully “OPEN” position by checking the position indicator on top of the stem, as shown to the left. The position indicator on top of the stem should be 90° from the correctly adjusted “SHUT” position.



**4a.** Using a hex key wrench, tighten the internal set screw (clockwise) until it contacts the internal quadrant gear.

**4b.** While holding the internal set screw in position with the hex key wrench, tighten the hex lock nut (clockwise).



**5.** Verify proper operation of the gear operator by turning the handwheel. Repeat the prior steps of this procedure, if necessary.

**6.** Replace the dust cap and indicator cap.

# ADJUSTING THE TRAVEL LIMIT STOPS FOR 10 – 12-INCH/DN250 – DN300 SERIES 765 AND 705 BUTTERFLY VALVES WITH GEAR OPERATORS

- Adjustment of the travel limit stops can be performed while the system is operational.  
**NOTE:** Cycling of the valve to test travel limit stop adjustments may affect downstream equipment. Refer to the instructions on this and the following pages for detailed instructions on how to adjust the travel limit stops.

## Adjusting and Setting the “SHUT” Travel Limit Stops of the Gear Operator

1. Turn the handwheel of the gear operator counterclockwise to verify that the valve disc is NOT in the fully “SHUT” position.

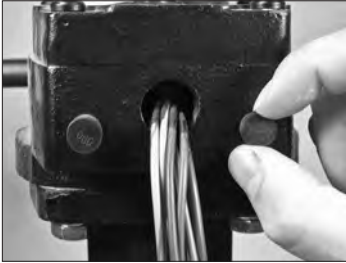

2. Remove the dust cap from the right side of the gear operator.

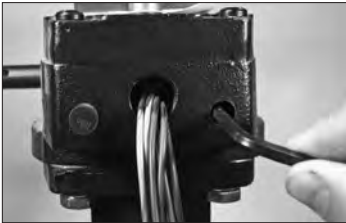

3a. Using a hex key wrench, loosen the internal set screw counterclockwise to increase the distance for disc travel.

3b. Using a hex key wrench, tighten the internal set screw clockwise to decrease the distance for disc travel.

3c. Turn the handwheel of the gear operator in the clockwise direction to place the valve disc in the fully “SHUT” position. Confirm that the valve is providing shutoff service. Repeat steps 3a and 3b, as necessary.

### NOTICE

- System pressure upstream of the valve may increase while the valve disc is in the fully “SHUT” position.
- Flow downstream of the valve will be interrupted with the disc in the fully “SHUT” position.

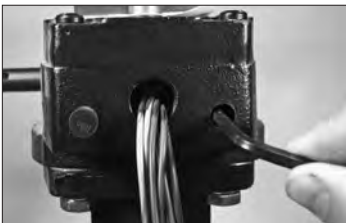

4. With the valve disc in the fully “SHUT” position, tighten the internal set screw (clockwise) with a hex key wrench.

5. Verify proper operation of the gear operator by turning the handwheel.

6. Replace the dust cap, and follow the “OPEN” travel limit stop adjustment procedure on the following page.

## Adjusting and Setting the “OPEN” Travel Limit Stops of the Gear Operator

1. Turn the handwheel of the gear operator clockwise to place the valve disc in the slightly “OPEN” position.



2. Remove the dust cap from the left side of the gear operator.



3a. Using a hex key wrench, loosen the internal set screw counterclockwise.

3b. Turn the handle of the gear operator to place the valve disc in the desired “OPEN” position.



4. With the valve disc in the desired “OPEN” position, tighten the internal set screw (clockwise) with a hex key wrench.

5. Verify proper operation of the gear operator by turning the handwheel.

6. Replace the dust cap.

# CHECK VALVES

## NOTICE

- **To prevent a Victaulic Check Valve from rotating in the system, Victaulic recommends installing the valve with at least one Victaulic Rigid Coupling. If two Victaulic Flexible Couplings are used, additional support may be required to prevent valve rotation.**

- When installing a Victaulic Check Valve into the piping system, follow the instructions in this handbook for the applicable coupling.
- DO NOT use a Victaulic Check Valve as a support for the piping system.
- Placement of check valves too close to sources of unstable flow will shorten the life of the valve and may potentially damage the system. To extend valve life, valves should be installed a reasonable distance downstream from pumps, elbows, expanders, reducers, or other similar devices. Sound piping practices dictate a minimum of five times the pipe diameter for general use. Distances between three and five diameters are allowable, provided the flow velocity is less than 8 feet per second/2.4 meters per second. Distances less than three diameters are not recommended and will violate the Victaulic product warranty. **NOTE:** These distances do not apply to fire protection installations.

### **Series 416 and 816 Stainless Steel Check Valves**

- Series 416 and 816 Stainless Steel Check Valves can be installed either vertically (flow up) or horizontally with the arrow on the body pointing in the correct direction of flow through the pipeline.
- Series 416 and 816 Stainless Steel Check Valves CAN be connected directly to flanged components with Style 441, 741/841, and 743 Flange Adapters.

### **Series 712, 712S, and 713 Swing Check Valves**

- Series 712, 712S, and 713 Swing Check Valves shall be installed with the arrow on the body pointing in the correct direction of flow through the pipeline.
- Series 712, 712S, and 713 Swing Check Valves SHOULD NOT be installed vertically.
- Series 712, 712S, and 713 Swing Check Valves CAN be connected directly to flanged components with Style 441, 741/841, and 743 Flange Adapters.

### **Series 716 and 716H Check Valves**

- Series 716/716H Check Valves can be installed either vertically (flow up) or horizontally with the arrow on the body pointing in the correct direction of flow through the pipeline.
- Series 716/716H Check Valves CAN be connected directly to flanged components with Style 441, 741/841, and 743 Flange Adapters.
- To aid in lifting the valve during installation, an eye bolt is provided on 10 – 12-inch/ DN250 – DN300 sizes of Series 716 Check Valves. **DO NOT use the eye bolt as a support for the piping system.**

### **Series 717, 717H, 717R, and 717HR FireLock™ Check Valves**

- Series 717, 717H, 717R, and 717HR FireLock™ Check Valves can be installed either vertically (flow up) or horizontally with the arrow on the body pointing in the correct direction of flow through the pipeline.
- Style 741/841 and Style 744 *Vic-Flange* Adapters can be installed on either end of a Series 717, 717H, 717R, or 717HR FireLock™ Check Valve.

### **Series 779 Venturi Check Valve**

- Series 779 Venturi Check Valves can be installed either vertically (flow up) or horizontally with the arrow on the body pointing in the correct direction of flow through the pipeline.

**For Series 716/716H Check Valves, Series 717/717H/717R/717HR FireLock™ Check Valves, and Series 779 Venturi Check Valves:** The bushing or pipe plug that retains the shaft/disc shall be located at the top of the valve in horizontal installations (refer to the drawings to the right).

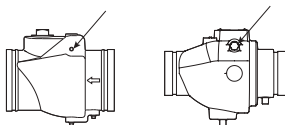

### **Series 415 Double-Disc Check Valve**



Correct Orientation for Horizontal Installation



Horizontal Installation



Incorrect Orientation for Horizontal Installation

- To aid in lifting the valve during installation, an eye bolt is provided on 6-inch/DN150 and larger sizes of Series 415 Double-Disc Check Valves. **DO NOT use the eye bolt as a support for the piping system.**
- Series 415 Double-Disc Check Valves can be installed either vertically (flow up) or horizontally with the arrow on the body pointing in the correct direction of flow through the pipeline.
- For horizontal installations, the center brace inside the Series 415 Double-Disc Check Valve shall be in the vertical position, as shown above. Failure to install the valve in the proper orientation will cause improper operation.
- Series 415 Double-Disc Check Valves CAN be connected directly to flanged components with Style 441, 741/841, and 743 Flange Adapters.
- When connecting a Series 415 Double-Disc Check Valve to a butterfly valve, a pipe spool is required between the two valves to prevent disc interference.
- When a Series 415 Double-Disc Check Valve is placed near a butterfly valve, orient the center brace/disc shaft of the Series 415 at right angles to the butterfly valve's stem. Failure to do so will cause uneven and unstable flow through the Series 415, resulting in noise and reduced valve life.

### **Series W715 AGS Double-Disc Check Valve**

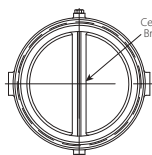

Correct Orientation for Horizontal Installation

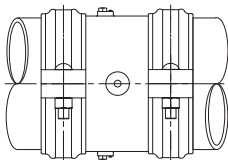

Horizontal Installation



Incorrect Orientation for Horizontal Installation

- Series W715 AGS Double-Disc Check Valves can be installed either vertically (flow up) or horizontally.
- For horizontal installations, the center brace inside the Series W715 AGS Double-Disc Check Valve shall be in the vertical position, as shown above. Failure to install the valve in the proper orientation will cause improper operation.
- Series W715 AGS Double-Disc Check Valves CAN be connected directly to flanged components with Style W741 AGS *Vic-Flange* Adapters.
- When connecting a Series W715 AGS Double-Disc Check Valve to an AGS Butterfly Valve, a pipe spool is required between the two valves to prevent disc interference.
- When a Series W715 AGS Double-Disc Check Valve is placed near an AGS Butterfly Valve, orient the center brace/disc shaft of the Series W715 at right angles to the butterfly valve's stem. Failure to do so will cause uneven and unstable flow through the Series W715, resulting in noise and reduced valve life.

# BALL VALVES

## Series 721 Ball Valve

## Series 722/722L Brass Body Ball Valves

## Series 723 Three-Port Diverter Ball Valve

## Series 726 Ball Valve

## Series 726D Super Duplex Ball Valve

## Series 726S Stainless Steel Type 316 Ball Valve

## Series 727 Ball Valve

## Series 728 FireLock™ Ball Valve

- **VICTAULIC BALL VALVES ARE NOT DESIGNED FOR THROTTLING SERVICES.**
- When installing a Victaulic Ball Valve into the piping system, follow the instructions in this handbook for the applicable coupling. For threaded valves, follow standard threading practices for proper installation.
- DO NOT use a Victaulic Ball Valve as a support for the piping system.
- When directly connecting a Victaulic End Cap to a Victaulic Ball Valve, use only a tapped end cap with a relief valve that can be opened to verify if the system is depressurized. If the Victaulic Ball Valve is opened and then closed unknowingly while the end cap is attached, the space between the ball and end cap will be filled and pressurized. A sudden release of energy can occur if the end cap is removed while the space behind it is pressurized. **PRESSURE SHALL BE VENTED THROUGH THE END CAP'S RELIEF VALVE BEFORE ATTEMPTING TO REMOVE THE CAP.**

<b>⚠ DANGER</b>	
	<ul style="list-style-type: none"><li>• When directly connecting a Victaulic End Cap to a Victaulic Ball Valve, use only a tapped end cap with a relief valve that can be opened to verify if the system is depressurized.</li><li>• Pressure shall be vented through the end cap's relief valve before attempting to remove the cap. Failure to follow these instructions could result in death or serious personal injury and property damage.</li></ul>

## Handling

- The valve shall remain in the “OPEN” position during handling.
- Verify that proper lifting equipment is available for handling larger, heavier valve sizes. Lift the valve by placing straps around the body. **DO NOT lift or suspend the valve by the handle plate, lock plate, or handle.**

## Storage

- Victaulic strongly recommends indoor storage of the valve. If outdoor storage is required, the valve shall be stored in the original shipping container and then covered completely with a weatherproof tarp.
- The valve shall remain in the “OPEN” position during storage. The valve shall not be stored in a partially-open position.
- The valve shall be stored with the stem in the vertical “UP” position (handwheel or top of handle pointing upward).

## Maintenance

- Regular maintenance is not required for Victaulic Ball Valves. However, the valve shall be cycled at least once per month or in accordance with jobsite requirements.

# PLUG VALVES

## Series 365 Vic-Plug AWWA Plug Valve

- Refer to the operation and maintenance manual supplied with the Series 365 Plug Valve for detailed information regarding valve installation, accessory installation, and maintenance requirements.
- DO NOT use a Series 365 as a support for the piping system.

## Series 377 Vic-Plug Balancing Valve

- The Series 377 Vic-Plug Balancing Valve is an eccentric, grooved-end plug valve designed specifically for throttling services.
- Refer to the operation and maintenance manual supplied with the Series 377 Vic-Plug Balancing Valve for detailed information regarding valve installation, accessory installation, and maintenance requirements.
- For 3 – 12-inch/DN80 – DN300 sizes, the Victaulic Style 307 Transition Coupling is available to directly connect the Series 377 to grooved-end steel and other NPS pipe. For installing these sizes of Vic-Plug valves into a piping system, follow the instructions for the Style 307 Transition Coupling contained in the I-300 Field Installation Handbook, which can be downloaded at victaulic.com.

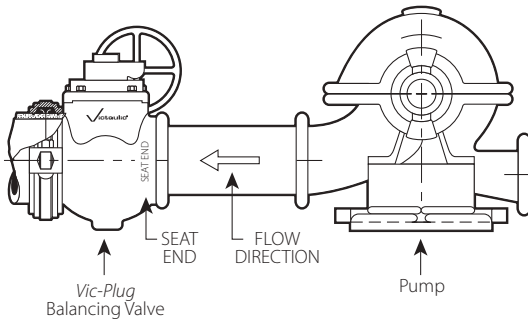

**Series 377 Vic-Plug Balancing Valves shall be installed with the seat upstream (closest to the pump discharge)**

- DO NOT use a Series 377 as a support for the piping system.
- When directly connecting a Victaulic End Cap to a Victaulic Plug Valve, use only a tapped end cap with a ball valve that can be opened to verify if the system is depressurized. If the plug valve is opened and then closed unknowingly while the end cap is attached, the space between the plug and end cap will be filled and pressurized. A sudden release of energy can occur if the end cap is removed while the space behind it is pressurized. **PRESSURE SHALL BE VENTED THROUGH THE END CAP'S BALL VALVE BEFORE ATTEMPTING TO REMOVE THE CAP.**

### **⚠ DANGER**



- When directly connecting a Victaulic End Cap to a Victaulic Plug Valve, use only a tapped end cap with a ball valve that can be opened to verify if the system is depressurized.
  - Pressure shall be vented through the end cap's ball valve before attempting to remove the cap.
- Failure to follow these instructions could result in death or serious personal injury and property damage.

# GATE VALVES

Series 371 Open Stem and Yoke (OS&Y) Gate Valve

Series 372 Non-Rising Stem (NRS) Gate Valve

Series 771 OS&Y Gate Valves

Series 772 NRS Gate Valves

Series W371 AGS OS&Y Gate Valve

Series W372 AGS NRS Gate Valve

- **VICTAULIC GATE VALVES ARE NOT DESIGNED FOR THROTTLING SERVICES.**
- Verify that there is adequate clearance around the valve for operating and maintenance activities.
- The valve can be mounted in vertical and horizontal runs. For horizontal pipe, the valve shall be installed with the stem in the vertical “UP” position (handwheel pointing upward).
- Verify that proper pipe supports are in place to prevent strain on the valve. The piping shall be laid out so that no thrust or bending forces act on the valve body during operation.
- DO NOT use a Victaulic Gate Valve as a support for the piping system.
- Verify that the piping is aligned and supported properly before attempting to install the valve.
- When painting a piping system, DO NOT apply paint to the stem and bolts/nuts.
- DO NOT stand on or use the handwheel as a support point.
- DO NOT over-torque the handwheel to force the valve into the “OPEN” or “CLOSED” position. Refer to the “Torque Limitations” table on the following page.
- When directly connecting a Victaulic End Cap to a Victaulic Gate Valve, use only a tapped end cap with a ball valve that can be opened to verify if the system is depressurized. If the gate valve is opened and then closed unknowingly while the end cap is attached, the space between the gate and end cap will be filled and pressurized. A sudden release of energy can occur if the end cap is removed while the space behind it is pressurized. **PRESSURE SHALL BE VENTED THROUGH THE END CAP’S BALL VALVE BEFORE ATTEMPTING TO REMOVE THE CAP.**

<b>⚠ DANGER</b>	
	<ul style="list-style-type: none"><li>• When directly connecting a Victaulic End Cap to a Victaulic Gate Valve, use only a tapped end cap with a ball valve that can be opened to verify if the system is depressurized.</li><li>• Pressure shall be vented through the end cap’s ball valve before attempting to remove the cap.</li></ul> <p><b>Failure to follow these instructions could result in death or serious personal injury and property damage.</b></p>

## Handling

- The valve shall remain in the “CLOSED” position during handling.
- To prevent damage to the seats and sealing surfaces of the valve body, the plastic shipping caps shall remain in place until the time of installation.
- Verify that proper lifting equipment is available for handling larger, heavier valve sizes. Lift the valve by placing straps around the body. **DO NOT lift or suspend the valve by the handwheel.**

## Storage

- Victaulic strongly recommends indoor storage of the valve. If outdoor storage is required, the valve shall be stored in the original shipping container and then covered completely with a weatherproof tarp.
- The shipping caps shall remain in place to prevent debris from entering the valve body during storage.
- The valve shall remain in the “CLOSED” position during storage.

# GATE VALVES (CONTINUED)

## Installation

### NOTICE

- To prevent a Victaulic Gate Valve from rotating in the system, Victaulic recommends installing the valve with at least one Victaulic Rigid Coupling. If two Victaulic Flexible Couplings are used, additional support may be required to prevent valve rotation.

1. Prior to installation, check the valve for any damage. DO NOT use the valve if any damage is present.
2. Remove the plastic shipping caps from the valve body. To prevent damage to the sealing surfaces of the valve body, DO NOT use any sharp instruments to remove the shipping caps.
3. Verify that the valve is in the "CLOSED" position.
4. Follow the instructions in this handbook for the applicable coupling.
5. Place the system into service after all installation requirements have been met.

## Operation

1. Operate the valve by turning the handwheel in the counter-clockwise direction (top view) to the "OPEN" position, then by turning the handwheel in the clockwise direction (top view) to the "CLOSED" position. Repeat this process several times to verify proper operation. **NOTE:** When the valve is in the fully "OPEN" position, turn the handwheel a quarter turn in the clockwise direction to prevent the stem/threads from locking up due to thermal expansion.

## Torque Limitations

Nominal Pipe Size inches/DN	Actual Pipe Outside Diameter inches/mm	Maximum Torque to Reach Fully "OPEN" Position or Fully "CLOSED" Position
2 1/2	2.875 73.0	38 ft-lbs 52 N•m
DN65	3.000 76.1	38 ft-lbs 52 N•m
3 DN80	3.500 88.9	38 ft-lbs 52 N•m
4 DN100	4.500 114.3	65 ft-lbs 88 N•m
DN125	5.500 139.7	106 ft-lbs 144 N•m
	6.500 165.1	106 ft-lbs 144 N•m
6 DN150	6.625 168.3	106 ft-lbs 144 N•m
8 DN200	8.625 219.1	180 ft-lbs 244 N•m
10 – 12 DN250 – DN300	10.750 – 12.750 273.0 – 323.9	300 ft-lbs 407 N•m
14 – 16 DN350 – DN400	14.000 – 16.000 355.6 – 406.4	400 ft-lbs 545 N•m

## Inspection

Inspect the valve on a frequency required by the building owner or their representative.

1. Verify that there is no leakage from the gland. If necessary, tighten the nuts at the gland flange evenly by alternating sides. Tighten the nuts ONLY to the point where leakage stops. Overtightening the packing can make the valve difficult to operate.
2. If the handwheel becomes loose, open the valve by turning the handwheel one to two turns in the counterclockwise direction, then tighten the handwheel nut.



# Fire Pump Test Meter

## Installation Instructions

# SERIES 735 FIRE PUMP TEST METER

Victaulic Series 735 Fire Pump Test Meters are designed specifically for test fire pumps, in accordance with NFPA 20 and 25 guidelines. The Series 735 contains grooved ends for installation with Victaulic couplings that are FM Approved. The maximum working pressure for Model "L" Series 735 Fire Pump Test Meters is 175 psi/1200 kPa, and the Model "S" is rated to 500 psi/3450 kPa.

To ensure proper installation and accurate flow readings, all sizes of Series 735 Fire Pump Test Meters have a minimum straight-pipe requirement of five diameters upstream and two diameters downstream from any valve or fitting (refer to the drawing below).

**NOTE:** The Series 735 can be installed either horizontally or vertically.

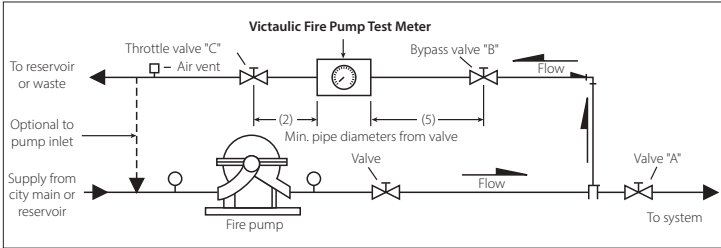

## Operating Instructions for Victaulic Series 735 Fire Pump Test Meters

1. Close the system valve "A."
2. Fully open the bypass valve "B" and throttle valve "C."
3. Purge the meter located on the Series 735 Fire Pump Test Meter as follows:  
Open station shutoff valves (below meter) and vent valves (above meter). When a steady stream of water passes through each plastic hose, the meter is purged of air. Close all valves after the air is purged.
4. Start the fire pump and read the meter in gpm ( $m^3/hr$ ).
5. Refer to the gpm requirement for the pump and adjust the throttle valve to achieve various flow readings. Record the gpm, suction pressure, and discharge pressures, etc., in accordance with NFPA 20 and 25 guidelines and the requirements established by the local authority having jurisdiction.
6. After the test is complete, open the system valve "A" and then close the bypass valve "B" and throttle valve "C."

# Resources

## English and Metric Conversion Chart

Convert Imperial (U.S.) to Metric			Convert Metric to Imperial (U.S.)			
25.4	×	inch (in)	↔	millimeter (mm)	×	0.03937
0.3048	×	feet (ft)	↔	meter (m)	×	3.281
0.4536	×	pound mass (lb)	↔	kilogram (kg)	×	2.205
28.35	×	ounce (oz)	↔	gram (g)	×	0.03527
6.894	×	pound per square inch (psi)	↔	kilopascal (kPa)	×	0.145
.069	×	pound per square inch (psi)	↔	Bar (bar)	×	14.5
4.45	×	pound force (lbf)	↔	newton (N)	×	0.2248
1.356	×	pound-foot (lbf-ft)	↔	Newton-meter (N·m)	×	0.738
$(F - 32) \div 1.8$		Fahrenheit (°F)	↔	Celsius (°C)		$(C + 17.78) \times 1.8$
745.7	×	Horsepower (hp)	↔	Watts (W)	×	$1.341 \times 10^{-3}$
3.785	×	Gal. per Min. (GPM)	↔	Liters per min. (L/min)	×	0.2642
0.0038	×	Gal. per Min. (GPM)	↔	Cubic Meters per min. (m <sup>3</sup> /min)	×	264.2

## Minutes Converted to Decimals of a Degree

Minutes	Degrees
1	.0166
2	.0333
3	.0500
4	.0666
5	.0833
6	.1000
7	.1166
8	.1333
9	.1500
10	.1666
11	.1833
12	.2000
13	.2166
14	.2333
15	.2500

Minutes	Degrees
16	.2666
17	.2833
18	.3000
19	.3166
20	.3333
21	.3500
22	.3666
23	.3833
24	.4000
25	.4166
26	.4333
27	.4500
28	.4666
29	.4833
30	.5000

Minutes	Degrees
31	.5166
32	.5333
33	.5500
34	.5666
35	.5833
36	.6000
37	.6166
38	.6333
39	.6500
40	.6666
41	.6833
42	.7000
43	.7166
44	.7333
45	.7500

Minutes	Degrees
46	.7666
47	.7833
48	.8000
49	.8166
50	.8333
51	.8500
52	.8666
53	.8833
54	.9000
55	.9166
56	.9333
57	.9500
58	.9666
59	.9833
60	1.0000

# ANSI Commercial Pipe Sizes

Size		Nominal Wall – inches/mm						Thickness – inches/mm								
Nominal Pipe Size inches	Actual Pipe Outside Diameter inches/mm	Sch. 5S	Sch. 10S	Sch. 10	Sch. 20	Sch. 30	Std.	Sch. 40	Sch. 60	Extra Strong	Sch. 80	Sch. 100	Sch. 120	Sch. 140	Sch. 160	XX Strong
1/8	0.405 10.3	—	0.049 1.2	—	—	—	0.068 1.7	0.068 1.7	—	0.095 2.4	0.095 2.4	—	—	—	—	—
1/4	0.540 13.7	—	0.065 1.7	—	—	—	0.088 2.2	0.088 2.2	—	0.119 3.0	0.119 3.0	—	—	—	—	—
3/8	0.675 17.1	—	0.065 1.7	—	—	—	0.091 2.3	0.091 2.3	—	0.126 3.2	0.126 3.2	—	—	—	—	—
1/2	0.840 21.3	0.065 1.7	0.083 2.1	—	—	—	0.109 2.8	0.109 2.8	—	0.147 3.7	0.147 3.7	—	—	—	0.188 4.8	0.294 7.5
3/4	1.050 26.9	0.065 1.7	0.083 2.1	—	—	—	0.113 2.9	0.113 2.9	—	0.154 3.9	0.154 3.9	—	—	—	0.219 5.6	0.308 7.8
1	1.315 33.7	0.065 1.7	0.109 2.8	—	—	—	0.133 3.4	0.133 3.4	—	0.179 4.5	0.179 4.5	—	—	—	0.250 6.4	0.358 9.1
1 1/4	1.660 42.4	0.065 1.7	0.109 2.8	—	—	—	0.140 3.6	0.140 3.6	—	0.191 4.9	0.191 4.9	—	—	—	0.250 6.4	0.382 9.7
1 1/2	1.900 48.3	0.065 1.7	0.109 2.8	—	—	—	0.145 3.7	0.145 3.7	—	0.200 5.1	0.200 5.1	—	—	—	0.281 7.1	0.400 10.2
2	2.375 60.3	0.065 1.7	0.109 2.8	—	—	—	0.154 3.9	0.154 3.9	—	0.218 5.5	0.218 5.5	—	—	—	0.344 8.7	0.436 11.1
2 1/2	2.875 73.0	0.083 2.1	0.120 3.0	—	—	—	0.203 5.2	0.203 5.2	—	0.276 7.0	0.276 7.0	—	—	—	0.375 9.5	0.552 14.0
3	3.500 88.9	0.083 2.1	0.120 3.0	—	—	—	0.216 5.5	0.216 5.5	—	0.300 7.6	0.300 7.6	—	—	—	0.438 11.1	0.600 15.2



# ANSI Commercial Pipe Sizes

Nominal Pipe Size inches	Actual Pipe Outside Diameter inches/mm	Nominal Wall – inches/mm						Thickness – inches/mm								
		Sch. 5S	Sch. 10S	Sch. 10	Sch. 20	Sch. 30	Std.	Sch. 40	Sch. 60	Extra Strong	Sch. 80	Sch. 100	Sch. 120	Sch. 140	Sch. 160	XX Strong
3 1/2	4.000 101.6	0.083 2.1	0.120 3.0	—	—	—	0.226 5.7	—	0.318 8.1	—	—	—	—	—	—	—
4	4.500 114.3	0.083 2.1	0.120 3.0	—	—	—	0.237 6.0	—	0.337 8.6	—	—	0.438 11.1	—	—	0.531 13.5	0.674 17.1
5	5.563 141.3	0.109 2.8	0.134 3.4	—	—	—	0.258 6.6	—	0.375 9.5	—	—	0.500 12.7	—	—	0.625 15.9	0.750 19.1
6	6.625 168.3	0.109 2.8	0.134 3.4	—	—	—	0.280 7.1	—	0.432 11.0	—	—	0.562 14.3	—	—	0.719 18.3	0.864 21.9
8	8.625 219.1	0.109 2.8	0.148 3.8	—	0.250 6.4	0.277 7.0	0.322 8.2	0.406 10.3	0.500 12.7	0.594 15.1	0.719 18.3	0.812 20.6	0.906 23.0	1.000 25.4	1.125 28.6	1.250 31.8
10	10.750 273.0	0.134 3.4	0.165 4.2	—	0.250 6.4	0.307 7.8	0.365 9.3	0.500 12.7	0.594 15.1	0.719 18.3	0.844 21.4	1.000 25.4	1.125 28.6	1.250 31.8	1.406 35.7	1.594 40.5
12	12.750 323.9	0.156 4.0	0.180 4.6	—	0.250 6.4	0.330 8.4	0.375 9.5	0.500 12.7	0.594 15.1	0.719 18.3	0.844 21.4	1.000 25.4	1.125 28.6	1.250 31.8	1.406 35.7	1.594 40.5
14	14.000 355.6	0.156 4.0	0.188 4.8	0.250 6.4	0.312 7.9	0.375 9.5	0.438 11.1	0.500 12.7	0.594 15.1	0.719 18.3	0.844 21.4	1.000 25.4	1.125 28.6	1.250 31.8	1.406 35.7	1.594 40.5
16	16.000 406.4	0.165 4.2	0.188 4.8	0.250 6.4	0.312 7.9	0.375 9.5	0.438 11.1	0.500 12.7	0.594 15.1	0.719 18.3	0.844 21.4	1.000 25.4	1.125 28.6	1.250 31.8	1.406 35.7	1.594 40.5
18	18.000 457.0	0.165 4.2	0.188 4.8	0.250 6.4	0.312 7.9	0.375 9.5	0.438 11.1	0.500 12.7	0.594 15.1	0.719 18.3	0.844 21.4	1.000 25.4	1.125 28.6	1.250 31.8	1.406 35.7	1.594 40.5
20	20.000 508.0	0.188 4.8	0.218 5.5	0.250 6.4	0.375 9.5	0.500 12.7	0.375 9.5	0.594 15.1	0.719 18.3	0.844 21.4	1.000 25.4	1.125 28.6	1.250 31.8	1.406 35.7	1.594 40.5	1.781 45.2



## ANSI Commercial Pipe Sizes

Size		Nominal Wall – inches/mm						Thickness – inches/mm								
Nominal Pipe Size inches	Actual Pipe Outside Diameter inches/mm	Sch. 5S	Sch. 10S	Sch. 10	Sch. 20	Sch. 30	Std.	Sch. 40	Sch. 60	Extra Strong	Sch. 80	Sch. 100	Sch. 120	Sch. 140	Sch. 160	XX Strong
22	22.000 559.0	0.188 4.8	0.218 5.5	0.250 6.4	0.375 9.5	0.500 12.7	0.375 9.5	—	0.875 22.2	0.500 12.7	1.125 28.6	1.375 34.9	1.625 41.3	1.875 47.6	2.125 54.0	—
24	24.000 610.0	0.218 5.5	0.250 6.4	0.250 6.4	0.375 9.5	0.562 14.3	0.375 9.5	0.688 17.5	0.969 24.6	0.500 12.7	1.219 31.0	1.531 38.9	1.812 46.0	2.062 52.4	2.344 59.5	—
26	26.000 660.4	—	—	0.312 7.9	0.500 12.7	—	0.375 9.5	—	—	0.500 12.7	1.313 33.4	—	—	—	—	—
28	28.000 711.0	—	—	0.312 7.9	0.500 12.7	0.625 15.9	0.375 9.5	—	—	0.500 12.7	—	—	—	—	—	—
30	30.000 762.0	0.250 6.4	0.312 7.9	0.312 7.9	0.500 12.7	0.625 15.9	0.375 9.5	—	—	0.500 12.7	—	—	—	—	—	—
32	32.000 813.0	—	—	0.312 7.9	0.500 12.7	0.625 15.9	0.375 9.5	0.688 17.5	—	0.500 12.7	—	—	—	—	—	—
34	34.000 863.6	—	—	0.312 7.9	0.500 12.7	0.625 15.9	0.375 9.5	0.688 17.5	—	0.500 12.7	—	—	—	—	—	—
36	36.000 914.0	—	—	0.312 7.9	0.500 12.7	0.625 15.9	0.375 9.5	0.750 19.1	—	0.500 12.7	—	—	—	—	—	—
42	42.000 1067.0	—	—	—	0.375 9.5	—	—	—	—	0.500 12.7	—	—	—	—	—	—
48	48.000 1219.0	—	—	—	0.375 9.5	—	—	—	—	0.500 12.7	—	—	—	—	—	—

## Decimal Equivalents of Fractions

Fraction in inches	Decimal Equivalent inches	Decimal Equivalent millimeters
$\frac{1}{64}$	0.016	0.397
$\frac{1}{32}$	0.031	0.794
$\frac{3}{64}$	0.047	1.191
$\frac{1}{16}$	0.063	1.588
$\frac{5}{64}$	0.781	1.984
$\frac{3}{32}$	0.094	2.381
$\frac{7}{64}$	0.109	2.778
$\frac{1}{8}$	0.125	3.175
$\frac{9}{64}$	0.141	3.572
$\frac{5}{32}$	0.156	3.969
$\frac{11}{64}$	0.172	4.366
$\frac{3}{16}$	0.188	4.763
$\frac{13}{64}$	0.203	5.159
$\frac{7}{32}$	0.219	5.556
$\frac{15}{64}$	0.234	5.953
$\frac{1}{4}$	0.250	6.350
$\frac{17}{64}$	0.266	6.747
$\frac{9}{32}$	0.281	7.144
$\frac{19}{64}$	0.297	7.541
$\frac{5}{16}$	0.313	7.938
$\frac{21}{64}$	0.328	8.334
$\frac{1}{3}$	0.333	8.467
$\frac{11}{32}$	0.344	8.731
$\frac{23}{64}$	0.359	9.128
$\frac{3}{8}$	0.375	9.525
$\frac{25}{64}$	0.391	9.922
$\frac{13}{32}$	0.406	10.319
$\frac{27}{64}$	0.422	10.716
$\frac{7}{16}$	0.438	11.113
$\frac{29}{64}$	0.453	11.509
$\frac{15}{32}$	0.469	11.906
$\frac{1}{2}$	0.500	12.700

Fraction in inches	Decimal Equivalent inches	Decimal Equivalent millimeters
$\frac{33}{64}$	0.516	13.097
$\frac{17}{32}$	0.531	13.494
$\frac{35}{64}$	0.547	13.891
$\frac{9}{16}$	0.563	14.288
$\frac{37}{64}$	0.578	14.684
$\frac{19}{32}$	0.594	15.081
$\frac{39}{64}$	0.609	15.478
$\frac{5}{8}$	0.625	15.875
$\frac{41}{64}$	0.641	16.272
$\frac{21}{32}$	0.656	16.669
$\frac{43}{64}$	0.672	17.066
$\frac{11}{16}$	0.688	17.463
$\frac{45}{64}$	0.703	17.859
$\frac{23}{32}$	0.719	18.256
$\frac{47}{64}$	0.734	18.653
$\frac{3}{4}$	0.750	19.050
$\frac{49}{64}$	0.766	19.447
$\frac{25}{32}$	0.781	19.844
$\frac{51}{64}$	0.797	20.241
$\frac{13}{16}$	0.813	20.638
$\frac{53}{64}$	0.828	21.034
$\frac{27}{32}$	0.844	21.431
$\frac{55}{64}$	0.859	21.828
$\frac{7}{8}$	0.875	22.225
$\frac{57}{64}$	0.891	22.622
$\frac{29}{32}$	0.906	23.019
$\frac{59}{64}$	0.922	23.416
$\frac{15}{16}$	0.938	23.813
$\frac{61}{64}$	0.953	24.209
$\frac{31}{32}$	0.969	24.606
$\frac{63}{64}$	0.984	25.003
1	1.000	25.400

## Pressure to Feet-of-Head of Water

Pounds Per Square Inch	Feet of Head
1	2.31
2	4.62
3	6.93
4	9.24
5	11.54
6	13.85
7	16.16
8	18.47
9	20.78
10	23.09
15	34.63
20	46.18
25	57.72
30	69.27
40	92.36
50	115.45
60	138.54
70	161.63
80	184.72
90	207.81

Pounds Per Square Inch	Feet of Head
100	230.90
110	253.93
120	277.07
130	300.16
140	323.25
150	346.34
160	369.43
170	392.52
180	415.61
200	461.78
250	577.24
300	692.69
350	808.13
400	922.58
500	1154.48
600	1385.39
700	1616.30
800	1847.20
900	2078.10
1000	2309.00

## Feet-of-Head of Water to Pressure

Feet of Head	Pounds Per Square Inch
1	0.43
2	0.87
3	1.30
4	1.73
5	2.17
6	2.60
7	3.03
8	3.46
9	3.90
10	4.33
15	6.50
20	8.66
25	10.83
30	12.99
40	17.32
50	21.65
60	25.99
70	30.32
80	34.65
90	39.98

Feet of Head	Pounds Per Square Inch
100	43.31
110	47.64
120	51.97
130	56.30
140	60.63
150	64.96
160	69.29
170	73.63
180	77.96
200	86.62
250	108.27
300	129.93
350	151.58
400	173.24
500	216.55
600	259.85
700	303.16
800	346.47
900	389.78
1000	433.00



## Pressure to Meter Water Column

kPa	Meter Water Column
10	1.02
15	1.53
20	2.04
25	2.55
30	3.06
40	4.08
50	5.10
60	6.12
70	7.14
80	8.16
90	9.18
100	10.20
110	11.22
120	12.24
130	13.26
140	14.28
150	15.30
160	16.32
170	17.34
180	18.36

kPa	Meter Water Column
180	18.36
190	19.38
200	20.40
250	25.50
300	30.60
400	40.80
500	51.00
600	61.20
700	71.40
800	81.60
900	91.80
1000	102.00
1500	153.00
2000	204.00
2500	255.00
3000	306.00
4000	408.00
5000	510.00
6000	612.00
7000	714.00

## Meter Water Column to Pressure

Meter Water Column	kPa
1	9.8
2	19.6
3	29.4
4	39.2
5	49.0
6	58.8
7	68.6
8	78.4
9	88.2
10	98.0
11	108.0
12	118.0
13	127.0
14	137.0
15	147.0
20	196.0
25	245.0
30	294.0
35	343.0
40	392.0

Meter Water Column	kPa
45	441.0
50	490.0
55	539.0
60	588.0
70	686.0
80	784.0
90	882.0
100	980.0
150	1470.0
200	1960.0
250	2450.0
300	2940.0
350	3430.0
400	3920.0
450	4410.0
500	4900.0
550	5390.0
600	5880.0
650	6370.0
700	6860.0



## Where to Find Installation Instructions for Additional Products



The following table provides a general listing of products and their respective installation instructions. Scan the QR code to the left to search for and download the applicable product instructions. **NOTE:** If two sources of instructions are referenced in this index, Victaulic recommends the use of both to ensure proper product installation. Contact Victaulic with any questions regarding this list (scan QR code on back cover for Victaulic locations).

Product	Where to Find Instructions on victaulic.com
Victaulic® End Caps	Search I-ENDCAP
VicFlex™ Products	Search I-VICFLEX
Aquamine™ Spline Couplings	Search I-Aquamine
Victaulic® Bolted Split-Sleeve Couplings	Instructions Shipped with Coupling (or search for specific coupling)
FireLock® Automatic Sprinkler Products	Search I-40
FireLock™ Fire Protection Valves and Accessories	Manual Shipped with Valve or Accessory (or search for specific valve or accessory)
Pipe Preparation Tools	Manual and Repair Parts List Shipped with Tool (or search for specific tool)
Vic-Press Schedule 10S System Products	Search I-P500
Series 76G Automatic Balancing Valve	Search I-76G
Series 76B/76K/76S/76T/76V Automatic Balancing Valves	Search I-76T
Series 121, 122, 124, and E125 Installation-Ready™ Butterfly Valves Installation and Gear Operator Conversion Instructions	Search I-120
Series 247 FireLock Residential Zone Control Riser Module Assembly	Search I-247
Series 317 AWWA Check Valve	Search I-317
Series 365 AWWA Vic-Plug® Valve (3 – 12-inch/88.9 – 323.9-mm Sizes)	Search I-365sm and I-300
Series 377 Vic-Plug Balancing Valve	Search I-365sm and I-100
Series 608N Copper Connection Butterfly Valve	Search I-600
Series 700 Butterfly Valve	Search I-100
Series 705 FireLock™ Butterfly Valve	Search I-765-705, I-BFV_KIT, and I-100
Series 707C FireLock™ Butterfly Valve with Supervised-Closed Switches	Search I-766_707C, I-BFV_KIT, and I-100
Series 712/712S Swinger® Check Valve	Search I-100
Series 713 Swinger Check Valve	Search I-100
Series W715 AGS™ Dual-Disc Vic-Check Valve	Search I-W100
Series 716H/716 Check Valves	Search I-100
Series 717H/717 FireLock™ Check Valves	Search I-100



<b>Product</b>	<b>Where to Find Instructions on victaulic.com</b>
Series 717HR/717R FireLock™ Check Valves	Search I-100
Series 722 Brass Body Ball Valve	Search I-100
Series 723/723S Diverter Ball Valve	Search I-100
Series 726/726S Ball Valve	Search I-726-726S and I-100
Series 728 FireLock™ Ball Valve	Search I-728 and I-100
Series 730 Vic-Strainer Tee Type	Search I-730_732AGS
Series W730 AGS™ Vic-Strainer Tee Type	Search I-730_732AGS
Series 731-D Suction Diffuser	Search I-731-D_W731-D
Series W731-D AGS™ Suction Diffuser	Search I-731-D_W731-D
Series 732 Vic-Strainer Wye Type	Search I-730_732AGS
Series W732 AGS Vic-Strainer Wye Type	Search I-730_732AGS
Series 733 Venturi Indicator	Search I-100
Series 747M FireLock™ Zone Control Riser Module Assembly	Search I-747M
Series 761 Vic-300 MasterSeal™ Butterfly Valve	Search I-VIC300MS and I-100
Series W761 AGS™ Vic-300 Butterfly Valve	Search I-AGS.GO and I-W100
Series 765 FireLock™ Butterfly Valve	Search I-765-705 and I-100
Series 766 FireLock™ Butterfly Valve with Supervised-Closed Switches	Search I-766_707C, I-BFV_KIT, and I-100
Series 779 Venturi Check Valve and Flow Measuring Kit	Search I-100
TA Series Valves and Meters	Instructions Shipped with Valve or Meter
Series 795 Knife Gate Valve	Search I-795 and I-900
Series 871 Gate Valve	Search I-871
Series 906 Knife Gate Valve	Search I-795 and I-900
Style 004N FireLock™ Installation-Ready™ Flexible Coupling	Search I-100
Style 005 FireLock™ Rigid Coupling	Search I-100
Style 009N FireLock EZ™ Installation-Ready™ Rigid Coupling	Search I-100
Style 07 Zero-Flex® Rigid Coupling (1 – 12-inch/33.7 – 323.9-mm Sizes)	Search I-100
Style 07 Zero-Flex Rigid Coupling (14 – 24-inch/355.6 – 610-mm Sizes)	Search I-100
Style W07 AGS™ Rigid Coupling	Search I-W100
Style W77/W77B/W77N AGS™ Flexible Couplings	Search I-W100
Style 22, 26, 28, 31, 41, and 44 Couplings for Vic-Ring Applications and Shouldered-End Pipe	Search I-6000

<b>Product</b>	<b>Where to Find Instructions on victaulic.com</b>
Style 31 Coupling for Grooved AWWA Ductile Iron Pipe	Search I-300
Style 71 Composite Coupling for PVC and Stainless Steel Pipe (Regional Availability Only)	Search I-100
Style 72 Outlet Coupling	Search I-100
Style 75 Flexible Coupling	Search I-100
Style 77/77A/77S Flexible Coupling	Search I-100
Style 77DX Duplex Stainless Steel Flexible Coupling	Search I-100
Style 78/78A Snap-Joint™ Coupling	Search I-100
Style 89 Rigid Coupling for Stainless Steel	Search I-100
Style W89 AGS™ Rigid Coupling for Stainless Steel or Carbon Steel Pipe	Search I-W100
Style 99 <i>Roust-A-Bout</i> Coupling for Plain-End Steel Pipe	Search I-100
No. 101 (90° Elbow) FireLock™ Installation-Ready™ Fitting	Search I-100
No. 103 (45° Elbow) FireLock™ Installation-Ready™ Fitting	Search I-100
No. 102 Straight Tee FireLock™ Installation-Ready™ Fitting	Search I-100
No. 104 Bullhead Tee FireLock™ Installation-Ready™ Fitting	Search I-100
Style 107N QuickVic™ Installation-Ready™ Rigid Coupling	Search I-100
Style 107V QuickVic™ Installation-Ready™ Rigid Coupling	Search I-100
Style 108 FireLock™ IGS™ Installation-Ready™ Rigid Coupling	Search I-100
Style 109 FireLock™ Installation-Ready™ Rigid Coupling	Search I-100
Style 115 FireLock EZ™ Installation-Ready™ Reducing Coupling	Search I-100
No. 142 Welded Outlet	Search I-142 and I-100
No. 142F Welded Outlet	Search I-142F and I-100
Style 150 <i>Mover</i> Expansion Joint	Search 09.06
Style 152A Expansion Joint Coupling	Search I-152A
Style 155 Expansion Joint	Search 09.06
Style W155 AGS™ Expansion Joint	Search 09.06
Series 159 Flexible Loop	Search I-159
Style 171 Installation-Ready Composite Flexible Coupling	Search I-100
Style 177N QuickVic™ Flexible Coupling	Search I-100



<b>Product</b>	<b>Where to Find Instructions on victaulic.com</b>
Style 307 AWWA Transition Coupling	Search I-300
Style 341 <i>Vic-Flange</i> Adapter	Search I-300
Style 441 <i>Vic-Flange</i> Adapter	Search I-100
Style 475 Lightweight, Flexible Stainless Steel Coupling	Search I-100
Style 475DX Duplex Stainless Steel Flexible Coupling	Search I-100
Style 489 Rigid Coupling for Stainless Steel Pipe	Search I-100
Style 489DX Duplex Stainless Steel Rigid Coupling	Search I-100
Style 606-EN and 606-AS Rigid Coupling for Copper Tubing	Search I-600
Style 607 QuickVic™ Rigid Coupling for Copper Tubing	Search I-600
Style 622 <i>Mechanical-T</i> Bolted Branch Outlet for Copper Tubing	Search I-600
Style 641 <i>Vic-Flange</i> Adapter for Copper Tubing	Search I-600
Style 707-IJ NPS-to-JIS Transition Coupling	Search I-100
Style 720 TestMaster™ II Alarm Test Module	Search I-720
Style 720 TestMaster™ II Alarm Test Module with Pressure Relief Option	Search I-720PR
Style 735 Fire Pump Test Meter	Search I-100
Style 741 <i>Vic-Flange</i> Adapter	Search I-100
Style W741 AGS™ <i>Vic-Flange</i> Adapter	Search I-W100
Style 743 <i>Vic-Flange</i> Adapter	Search I-100
Style 744 FireLock™ Flange Adapter	Search I-100
Style 750 Reducing Coupling	Search I-100
Style 791 <i>Vic-Boltless</i> Coupling	Search I-100
Style 808 High-Pressure Coupling	Search I-808
Style 870 High-Performance Rigid Coupling	Search I-870
Style 904 Flange Adapter for HDPE-to-Flanged Pipe	Search I-900
Style 905 Coupling for Plain-End HDPE Pipe	Search I-900
Style 907 Transition Coupling for HDPE to Steel Pipe	Search I-900
Style 908 Coupling for Double-Grooved HDPE Pipe	Search I-900
Style 912 FireLock™ Low-Profile Sprinkler-Tee (Regional Availability Only)	Search I-100

<b>Product</b>	<b>Where to Find Instructions on victaulic.com</b>
Style 920 and 920N <i>Mechanical-T</i> Outlets	Search I-100
Style 922 FireLock™ Outlet-T	Search I-100
Style 923 Strapless Outlet	Search I-100
Style 924 Strapless Thermometer Outlet	Search I-100
Style 926 <i>Mechanical-T</i> Spigot Assembly	Search I-100
Style 994 <i>Vic-Flange</i> Adapter for HDPE Pipe	Search I-900
Style 995N Coupling for Plain-End HDPE Pipe	Search I-900
Style 997 Transition Coupling for Plain-End HDPE Pipe to Grooved-End Steel Pipe	Search I-900
Style 2970 Aquamine™ Plain-End Pipe Coupling	Search IT-2970
Style 2971 Aquamine™ Transition Coupling for Plain-End PVC Pipe to Plain-End HDPE Pipe	Search IT-2971
Style 2972 Aquamine™ Transition Coupling for Plain-End PVC Pipe to Grooved Steel Pipe	Search IT-2972
Style HP-70 Rigid Coupling	Search I-100
Style HP-70ES Rigid Coupling with EndSeal® Gasket	Search I-100
Style XL77 Flexible Coupling for Joining “XL” Elbows to NPS Carbon Steel Pipe	Search IT-XL77
Style XL79 Flexible Coupling for Joining “XL” Elbows to “XL” Elbows	Search IT-XL79

# Product Data

## NOTICE

- This "Product Data" section contains center-to-end, end-to-end, take-out, and similar overall dimensions for select Victaulic products.
- This section is not a complete listing of all products/dimensions and is for general reference only. Always refer to the current Victaulic product publication to verify the most up-to-date dimensional information; to find dimensional information for products not listed in this section; and for important notes regarding applications, pressure ratings, operating temperatures, etc. Product publications can be downloaded at [victaulic.com](http://victaulic.com).

Scan QR code for listing of fitting publications on [victaulic.com](http://victaulic.com).



# QUICKVIC™ FITTINGS FOR OGS GROOVED PIPE

No. V10 – 90° QuickVic™ Elbow

No. V11 – 45° QuickVic™ Elbow

No. V20 – QuickVic™ Straight Tee



NO. V10



NO. V11

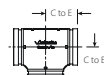

NO. V20

Nominal Size inches/DN	Actual Pipe Outside Diameter inches/mm	No. V10	No. V11	No. V20
		C to E inches/mm	C to E inches/mm	C to E inches/mm
2 DN50	2.375 60.3	2.75 70	2.00 51	2.75 70
2½	2.875 73.0	3.00 76	2.25 57	3.00 76
3 DN80	3.500 88.9	3.50 89	2.50 64	3.50 89
4 DN100	4.500 114.3	4.00 102	3.00 76	4.00 102
5	5.563 141.3	4.88 124	3.25 83	4.88 124
6 DN150	6.625 168.3	5.50 140	3.50 89	5.50 140
8 DN200	8.625 219.1	6.88 175	4.25 108	6.88 175
10 DN250	10.750 273.0	8.25 210	4.00 102	8.25 210
12 DN300	12.750 323.9	9.50 241	4.50 114	9.50 241



For the most up-to-date dimensional information, always refer to the current Victaulic product publication, which can be downloaded at [victaulic.com](http://victaulic.com).



# QUICKVIC™ FITTINGS FOR OGS GROOVED PIPE

No. V15F ANSI Class 150 QuickVic™ Flanged Elbow (Flat Face)

No. V15R ANSI Class 150 QuickVic™ Flanged Elbow (Raised Face)

No. V16F ANSI Class 300 QuickVic™ Flanged Elbow (Flat Face)

No. V16R ANSI Class 300 QuickVic™ Flanged Elbow (Raised Face)

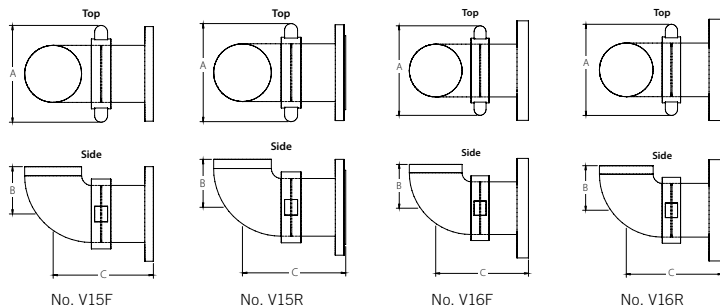

Nominal Size inches/ DN	Actual Pipe Outside Diameter inches/mm	No. V15F and V15R			No. V16F and V16R		
		A inches mm	B inches mm	C inches mm	A inches mm	B inches mm	C inches mm
2 DN50	2.375 60.3	6.13 156	2.75 70	6.88 175	6.13 156	2.75 70	6.88 175
2½	2.875 73.0	6.75 172	3.00 76	7.13 181	6.75 172	3.00 76	7.13 181
3 DN80	3.500 88.9	7.50 191	3.50 89	7.63 194	7.50 191	3.50 89	7.63 194
4 DN100	4.500 114.3	8.75 222	4.00 102	10.13 257	8.75 222	4.00 102	10.13 257
6 DN150	6.625 168.3	11.25 286	5.50 140	11.63 295	11.25 286	5.50 140	11.63 295
8 DN200	8.625 219.1	14.25 362	6.88 175	13.06 332	14.25 362	6.88 175	13.06 332
10 DN250	10.750 273.0	17.13 435	8.25 210	16.44 418	17.13 435	8.25 210	16.44 418
12 DN300	12.750 323.9	19.00 483	9.50 241	17.69 449	19.00 483	9.50 241	17.69 449



For the most up-to-date dimensional information, always refer to the current Victaulic product publication, which can be downloaded at [victaulic.com](http://victaulic.com).



# FITTINGS FOR OGS GROOVED PIPE

- No. 10 – 90° Elbow  
 No. 11 – 45° Elbow  
 No. 12 – 22½° Elbow  
 No. 13 – 11¼° Elbow

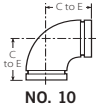

NO. 10

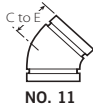

NO. 11

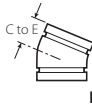

NO. 12

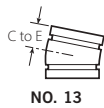
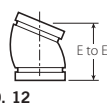

NO. 13

Nominal Size inches/DN	Actual Pipe Outside Diameter inches/mm	No. 10	No. 11	No. 12	No. 13
		C to E inches/mm	C to E inches/mm	C to E inches/mm	C to E inches/mm
¾ DN20	1.050 26.9	2.25 57	1.50 38	1.63 41	1.38 35
1 DN25	1.315 33.7	2.25 57	1.75 44	3.25@ 83	1.38 35
1¼ DN32	1.660 42.4	2.75 70	1.75 44	1.75 44	1.38 35
1½ DN40	1.900 48.3	2.75 70	1.75 44	1.75 44	1.38 35
2 DN50	2.375 60.3	3.25 83	2.00 51	1.88 48	1.38 35
2½	2.875 73.0	3.75 95	2.25 57	4.00@ 102	1.50 38
DN65	3.000 76.1	3.75 95	2.25 57	2.25 57	1.50 38
3 DN80	3.500 88.9	4.25 108	2.50 64	4.50@ 114	1.50 38
3½ DN90	4.000 101.6	4.50 114	2.75 70	2.50 64	1.75 44
	4.250 108.0	5.00 127	3.00 76	—	—
4 DN100	4.500 114.3	5.00 127	3.00 76	2.88 73	1.75 44
4½	5.000 127.0	5.25 133	3.13 79	3.50 89	1.88 48
	5.250 133.0	5.50 140	3.25 83	—	—
DN125	5.500 139.7	5.50 140	3.25 83	2.88 73	2.00 51
5	5.563 141.3	5.50 140	3.25 83	2.88 73	2.00 51
	6.250 159.0	6.50 165	3.50 89	—	—
	6.500 165.1	6.50 165	3.50 89	3.13 79	2.00 51
6 DN150	6.625 168.3	6.50 165	3.50 89	6.25@ 159	2.00 51
8 DN200	8.625 219.1	7.75 197	4.25 108	7.75@ 197	2.00 51



For the most up-to-date dimensional information, always refer to the current Victaulic product publication, which can be downloaded at [victaulic.com](http://victaulic.com).



# FITTINGS FOR OGS GROOVED PIPE

No. 10 – 90° Elbow

No. 11 – 45° Elbow

No. 12 – 22½° Elbow

No. 13 – 11¼° Elbow



NO. 10



NO. 11



NO. 12

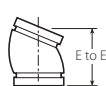

NO. 13

Nominal Size inches/DN	Actual Pipe Outside Diameter inches/mm	No. 10	No. 11	No. 12	No. 13
		C to E inches/mm	C to E inches/mm	C to E inches/mm	C to E inches/mm
10 DN250	10.750 273.0	9.00 229	4.75 121	4.38 111	2.13 54
12 DN300	12.750 323.9	10.00 254	5.25 133	4.88 124	2.25 57
14 <sup>1</sup> DN350	14.000 355.6	14.00 356	5.75 146	5.00 127	3.50 89
	14.843 377.0	14.84 377	6.13 156	—	—
16 <sup>1</sup> DN400	16.000 406.4	16.00 406	6.63 168	5.00 127	4.00 102
	16.772 426.0	16.75 425	7.00 178	—	—
18 <sup>1</sup> DN450	18.000 457.2	18.00 457	7.50 190	5.50 140	4.50 144
	18.898 480.0	18.88 480	7.83 200	—	—
20 <sup>1</sup> DN500	20.000 508.0	20.00 508	8.25 210	6.00 152	5.00 127
	20.866 530.0	20.88 530	8.63 219	—	—
24 <sup>1</sup> DN600	24.000 609.6	24.00 610	10.00 254	7.00 178	6.00 152
	24.803 630.0	24.80 630	10.25 261	—	—

<sup>1</sup> For 14-inch/DN350 and larger roll groove systems, Victaulic offers the Advanced Groove System (AGS). Refer to publication 20.05. For pricing and availability of cut groove fittings in this size, contact your nearest Victaulic sales representative.

@ Gooseneck design, end-to-end dimension



For the most up-to-date dimensional information, always refer to the current Victaulic product publication, which can be downloaded at [victaulic.com](http://victaulic.com).



# FITTINGS FOR OGS GROOVED PIPE

No. 100/L100 – 90° Long Radius Elbow

No. 110/L110 – 45° Long Radius Elbow

No. L20 – Tee

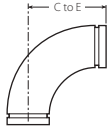

NO. 100/L100

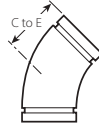

NO. 110/L110

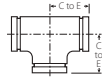

NO. L20

Nominal Size inches/DN	Actual Pipe Outside Diameter inches/mm	No. 100	No. L100	No. 110	No. L110	No. L20
		C to E inches/ mm	C to E inches/ mm	C to E inches/ mm	C to E inches/ mm	C to E inches/ mm
¾ DN20	1.050 26.9	2.50 64	—	1.88 48	—	—
1 DN25	1.315 33.7	2.88 73	—	2.25 57	—	—
1¼ DN32	1.660 42.4	3.25 83	—	2.38 60	—	—
1½ DN40	1.900 48.3	3.63 92	3.63 92	2.50 64	2.50 64	2.75 70
2 DN50	2.375 60.3	4.38 111	4.38 111	2.75 70	2.75 70	3.25 83
2½	2.875 73.0	5.13 130	5.13 130	3.00 76	3.00 76	3.75 95
3 DN80	3.500 88.9	5.88 149	5.88 149	3.38 86	3.38 86	4.25 108
4 DN100	4.500 114.3	7.50 191	7.50 191	4.00 102	4.00 102	5.00 127
5	5.563 141.3	9.25 235	—	4.88 124	—	—
	6.500 165.1	10.75 273	—	5.50 140	—	—
6 DN150	6.625 168.3	10.75 273	10.75 273	5.50 140	5.50 140	6.50 165
8 DN200	8.625 219.1	14.25 362	14.25 362	7.25 184	7.25 184	7.75 197
10 DN250	10.750 273.0	15.00 381	17.5 445	6.25 159	8.50 216	10.75 273
12 DN300	12.750 323.9	18.00 457	20.5 521	7.50 191	10.0 254	12.5 318
14 <sup>1</sup> DN350	14.000 355.6	21.00 533	—	8.75 222	—	—
16 <sup>1</sup> DN400	16.000 406.4	24.00 610	—	10.00 254	—	—
18 <sup>1</sup> DN450	18.000 457.2	27.00 686	—	11.25 286	—	—
20 <sup>1</sup> DN500	20.000 508.0	30.00 762	—	12.50 318	—	—
24 <sup>1</sup> DN600	24.000 609.6	36.00 914	—	15.00 381	—	—

<sup>1</sup> For 14-inch/DN350 and larger roll groove systems, Victaulic offers the Advanced Groove System (AGS). Refer to publication 20.05. For pricing and availability of cut groove fittings in this size, contact your nearest Victaulic sales representative.



For the most up-to-date dimensional information, always refer to the current Victaulic product publication, which can be downloaded at [victaulic.com](http://victaulic.com).



# FITTINGS FOR OGS GROOVED PIPE

No. 100-3D – 90° Long Radius Elbow

No. 14-3D – 60° Elbow

No. 110-3D – 45° Long Radius Elbow

No. 15-3D – 45° Elbow

No. 12-3D – 22½° Elbow

No. 13-3D – 11¼° Elbow

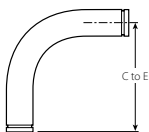

NO. 100-3D

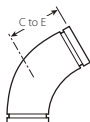

NO. 14-3D

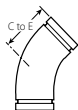

NO. 110-3D

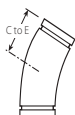

NO. 15-3D



NO. 12-3D



NO. 13-3D

Nominal Size inches/ DN	Actual Pipe Outside Diameter inches/ mm	No. 100-3D	No. 14-3D	No. 110-3D	No. 15-3D	No. 12-3D	No. 13-3D
		C to E inches/ mm	C to E inches/ mm	C to E inches/ mm	C to E inches/ mm	C to E inches/ mm	C to E inches/ mm
2 DN50	2.375 60.3	10.00 60.3	7.50 191	6.50 165	5.75 146	5.25 133	4.50 114
2½	2.875 73.0	11.50 292	8.25 210	7.25 184	6.00 152	5.50 140	4.75 121
3 DN80	3.500 88.9	13.00 330	9.25 235	7.75 197	6.50 165	5.75 146	5.00 127
3½ DN90	4.000 101.6	14.50 368	10.00 254	8.50 216	6.75 172	6.00 152	5.00 127
4 DN100	4.500 114.3	16.00 407	11.00 279	9.00 229	7.25 184	6.50 165	5.25 133
4½	5.000 127.0	18.00 457	12.25 311	10.00 254	8.25 210	7.25 184	5.75 146
5	5.563 141.3	20.00 508	13.75 349	11.25 286	9.00 229	8.00 203	6.50 165
6 DN150	6.625 168.3	24.00 610	16.50 419	13.50 343	10.75 273	9.50 241	7.75 197
8 DN200	8.625 219.1	32.00 813	22.00 559	18.00 457	14.50 368	12.75 324	10.50 267
10 DN250	10.750 273.0	40.00 1016	27.25 692	22.50 572	18.00 457	16.00 406	13.00 330
12 DN300	12.750 323.9	48.00 1219	32.75 832	27.00 286	21.75 553	19.25 489	15.50 394
14 DN350	14.000 355.6	56.00 1422	38.25 972	31.50 800	25.25 641	22.50 572	18.25 464
15 DN375	15.000 381.0	60.00 1524	41.00 1041	33.75 857	27.00 656	24.00 610	19.50 495
16 DN400	16.000 406.4	64.00 1626	43.75 1111	36.00 914	29.00 737	25.50 648	20.75 527
18 DN450	18.000 457.2	72.00 1829	49.25 1251	40.50 1029	32.50 826	28.75 730	23.25 591



For the most up-to-date dimensional information, always refer to the current Victaulic product publication, which can be downloaded at [victaulic.com](http://victaulic.com).



# FITTINGS FOR OGS GROOVED PIPE

No. 100-3D – 90° Long Radius Elbow

No. 14-3D – 60° Elbow

No. 110-3D – 45° Long Radius Elbow

No. 15-3D – 45° Elbow

No. 12-3D – 22½° Elbow

No. 13-3D – 11¼° Elbow

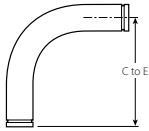

NO. 100-3D

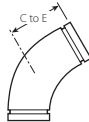

NO. 14-3D



NO. 110-3D

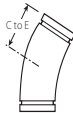

NO. 15-3D

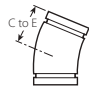

NO. 12-3D



NO. 13-3D

Nominal Size inches/ DN	Actual Pipe Outside Diameter inches/ mm	No. 100-3D	No. 14-3D	No. 110-3D	No. 15-3D	No. 12-3D	No. 13-3D
		C to E inches/ mm	C to E inches/ mm	C to E inches/ mm	C to E inches/ mm	C to E inches/ mm	C to E inches/ mm
20 DN500	20.000 508.0	80.00 2032	54.75 1391	45.00 1143	36.00 914	32.00 813	26.00 660
22 DN550	22.000 558.8	88.00 2235	60.25 1530	49.25 1251	39.75 1010	35.25 895	28.50 724
24 DN600	24.000 609.6	96.00 2438	65.50 1664	53.75 1365	43.25 1099	38.25 972	31.00 787

**NOTE FOR C-TO-E TOLERANCES:**

2 – 6 inch/DN50 – DN150 ± 1/8 inch/3.2 mm

8 – 15 inch/DN250 – DN375 ± 1/4 inch/6.4 mm

16 – 24 inch/DN400 – DN600 ± 3/8 inch/9.5 mm

**No. R-10G – Grooved x Grooved Reducing Base Support Elbow**

**No. R-10F – Grooved x Flanged Reducing Base Support Elbow**

Nominal Size inches/DN	C to E inches/mm	H inches/mm	B Diameter inches/mm
6 DN150 × 4 DN100	9.00 229	1.25 32	1.50 38
× 5	9.00 229	1.50 38	1.50 38
8 DN200 × 6 DN150	10.50 267	2.13 24	1.50 38
10 DN250 × 8 DN200	12.00 305	2.40 61	1.50 38

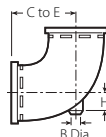

NO. R-10G

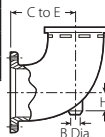

NO. R-10F



For the most up-to-date dimensional information, always refer to the current Victaulic product publication, which can be downloaded at [victaulic.com](http://victaulic.com).



# FITTINGS FOR OGS GROOVED PIPE

No. 100-5D – 90° Long Radius Elbow

No. 14-5D – 60° Elbow

No. 110-5D – 45° Long Radius Elbow

No. 15-5D – 45° Elbow

No. 12-5D – 22½° Elbow

No. 13-5D – 11¼° Elbow

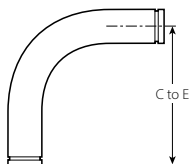

NO. 100-5D

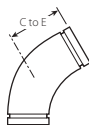

NO. 14-5D



NO. 110-5D

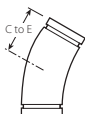

NO. 15-5D



NO. 12-5D



NO. 13-5D

Nominal Size inches/ DN	Actual Pipe Outside Diameter inches/ mm	No. 100-5D	No. 14-5D	No. 110-5D	No. 15-5D	No. 12-5D	No. 13-5D
		C to E inches/ mm	C to E inches/ mm	C to E inches/ mm	C to E inches/ mm	C to E inches/ mm	C to E inches/ mm
2 DN50	2.375 60.3	14.00 356	9.75 248	8.25 210	6.75 172	6.00 152	5.00 127
2½	2.875 73.0	16.50 419	11.25 286	9.25 235	7.50 191	6.50 165	5.25 133
3 DN80	3.500 88.9	19.00 488	12.75 324	10.25 260	8.00 203	7.00 178	5.50 140
3½ DN90	4.000 101.6	21.50 546	14.25 362	11.25 286	8.75 222	7.50 191	5.75 146
4 DN100	4.500 114.3	24.00 610	15.50 394	12.50 318	9.50 241	8.00 203	6.00 152
4½	5.000 127.0	27.00 686	17.50 445	13.75 349	10.50 267	9.00 229	6.75 172
5	5.563 141.3	30.00 762	19.50 495	15.50 394	11.75 299	10.00 254	7.50 191
6 DN150	6.625 168.3	36.00 914	23.25 591	18.50 470	14.00 356	12.00 305	9.00 229
8 DN200	8.625 219.1	48.00 1219	31.00 787	24.50 622	18.75 476	16.00 406	12.00 305
10 DN250	10.750 273.0	60.00 1524	39.00 991	30.75 781	23.50 597	20.00 508	15.00 381
12 DN300	12.750 323.9	72.00 1829	46.75 1188	37.00 940	28.00 711	24.00 610	18.00 457



For the most up-to-date dimensional information, always refer to the current Victaulic product publication, which can be downloaded at [victaulic.com](http://victaulic.com).



# FITTINGS FOR OGS GROOVED PIPE

No. 100-5D – 90° Long Radius Elbow

No. 14-5D – 60° Elbow

No. 110-5D – 45° Long Radius Elbow

No. 15-5D – 45° Elbow

No. 12-5D – 22½° Elbow

No. 13-5D – 11¼° Elbow

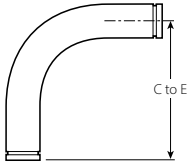

NO. 100-5D

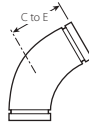

NO. 14-5D

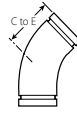

NO. 110-5D

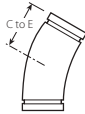

NO. 15-5D



NO. 12-5D



NO. 13-5D

Nominal Size inches/ DN	Actual Pipe Outside Diameter inches/ mm	No.	No.	No.	No.	No.	No.
		100-5D	14-5D	110-5D	15-5D	12-5D	13-5D
		C to E inches/ mm	C to E inches/ mm	C to E inches/ mm	C to E inches/ mm	C to E inches/ mm	C to E inches/ mm
14 DN350	14.000 355.6	84.00 2134	54.50 1384	43.00 1092	32.75 832	28.00 711	21.00 533
15 DN375	15.000 381.0	90.00 2286	58.25 1498	46.00 1168	35.25 895	30.00 762	22.50 572
16 DN400	16.000 406.4	96.00 2438	62.25 1581	49.25 1251	37.50 953	32.00 813	24.00 610
18 DN450	18.000 457.2	108.00 2743	70.00 1778	55.25 1403	42.25 1073	36.00 914	27.00 686
20 DN500	20.000 508.0	120.00 3048	77.75 1975	61.50 1562	46.75 1188	40.00 1016	30.00 762
22 DN550	22.000 558.8	132.00 3353	85.50 2172	67.50 1715	51.50 1308	44.00 1118	32.75 832
24 DN600	24.000 609.6	144.00 3658	93.25 2369	73.75 1873	56.25 1429	48.00 1219	35.75 908

## NOTE FOR C-TO-E TOLERANCES:

2 – 6 inch/DN50 – DN150 ± 1/8 inch/3.2 mm

8 – 15 inch/DN250 – DN375 ± 1/4 inch/6.4 mm

16 – 24 inch/DN400 – DN600 ± 3/8 inch/9.5 mm



For the most up-to-date dimensional information, always refer to the current Victaulic product publication, which can be downloaded at [victaulic.com](http://victaulic.com).



# FITTINGS FOR OGS GROOVED PIPE

No. 100-6D – 90° Long Radius Elbow

No. 14-6D – 60° Elbow

No. 110-6D – 45° Long Radius Elbow

No. 15-6D – 45° Elbow

No. 12-6D – 22½° Elbow

No. 13-6D – 11¼° Elbow

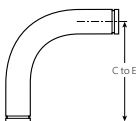

NO. 100-6D

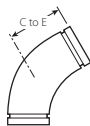

NO. 14-6D

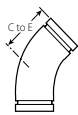

NO. 110-6D

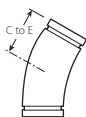

NO. 15-6D



NO. 12-6D



NO. 13-6D

Nominal Size inches/ DN	Actual Pipe Outside Diameter inches/ mm	No. 100-6D	No. 14-6D	No. 110-6D	No. 15-6D	No. 12-6D	No. 13-6D
		C to E inches/ mm	C to E inches/ mm	C to E inches/ mm	C to E inches/ mm	C to E inches/ mm	C to E inches/ mm
2 DN50	2.375 60.3	16.00 406	11.00 279	9.00 229	7.25 184	6.50 165	5.25 133
2½	2.875 73.0	19.00 483	12.75 324	10.25 260	8.00 203	7.00 178	5.50 140
3 DN80	3.500 88.9	22.00 559	14.50 368	11.50 292	8.75 222	7.50 191	5.75 146
3½ DN90	4.000 101.6	25.00 635	16.25 413	12.75 324	9.75 248	8.25 210	6.00 152
4 DN100	4.500 114.3	28.00 711	18.00 457	14.00 356	10.50 267	8.75 222	6.50 165
4½	5.000 127.0	31.50 800	20.00 508	15.75 400	11.75 299	10.00 254	7.25 184
5	5.563 141.3	35.00 889	22.25 565	17.50 445	13.00 330	11.00 279	8.00 203
6 DN150	6.625 168.3	42.00 1067	26.75 680	21.00 533	15.75 400	13.25 337	9.50 241
8 DN200	8.625 219.1	56.00 1422	35.75 908	28.00 711	21.00 533	17.50 445	12.75 324
10 DN250	10.750 273.0	70.00 1778	44.75 1137	35.00 889	26.00 660	22.00 559	16.00 406
12 DN300	12.750 323.9	84.00 2134	53.50 1359	41.75 1061	31.25 794	26.25 667	19.00 483



For the most up-to-date dimensional information, always refer to the current Victaulic product publication, which can be downloaded at [victaulic.com](http://victaulic.com).



# FITTINGS FOR OGS GROOVED PIPE

No. 18 – 90° Adapter Elbow

No. 19 – 45° Adapter Elbow

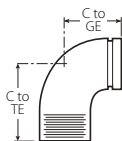

NO. 18

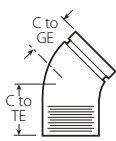

NO. 19

Nominal Size inches/DN	Actual Pipe Outside Diameter inches/mm	No. 18		No. 19	
		C to GE inches/mm	C to TE inches/mm	C to GE inches/mm	C to TE inches/mm
3/4 DN20	1.050 26.9	2.25 57	2.25 57	1.50 38	1.50 38
1 DN25	1.315 33.7	2.25 57	2.25 57	—	—
1 1/4 DN32	1.660 42.4	2.75 70	2.75 70	—	—
1 1/2 DN40	1.900 48.3	2.75 70	2.75 70	1.75 44	1.75 44
2 DN50	2.375 60.3	3.25 83	4.25 108	—	—
2 1/2	2.875 73.0	3.75 95	3.75 95	2.25 57	2.25 57
3 DN80	3.500 88.9	4.25 108	6.00 152	2.50 64	4.25 108
3 1/2 DN90	4.000 101.6	4.50 114	6.25 159	5.25 133	5.25 133
6 DN150	6.625 168.3	6.50 165	6.50 165	3.50 89	3.50 89



For the most up-to-date dimensional information, always refer to the current Victaulic product publication, which can be downloaded at [victaulic.com](http://victaulic.com).



# FITTINGS FOR OGS GROOVED PIPE

No. 20 – Tee  
No. 35 – Cross

No. 33 – True Wye  
No. 29M – Tee with Threaded Branch

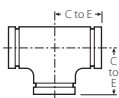

NO. 20



NO. 35

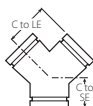

NO. 33

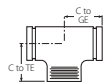

NO. 29M

Nominal Size inches/ DN	Actual Pipe Outside Diameter inches/ mm	No. 20	No. 35	No. 33		No. 29M	
		C to E inches/ mm	C to E inches/ mm	C to LE inches/ mm	C to SE inches/ mm	C to GE inches/ mm	C to TE inches/ mm
¾ DN20	1.050 26.9	2.25 57	2.25 57	2.25 57	2.00 51	2.25 57	2.25 57
1 DN25	1.315 33.7	2.25 57	2.25 57	2.25 57	2.25 57	2.25 57	2.25 57
1¼ DN32	1.660 42.4	2.75 70	2.75 70	2.75 70	2.50 64	2.75 70	2.75 70
1½ DN40	1.900 48.3	2.75 70	2.75 70	2.75 70	2.75 70	2.75 70	2.75 70
2 DN50	2.375 60.3	3.25 83	3.25 83	3.25 83	2.75 70	3.25 83	4.25 108
2½	2.875 73.0	3.75 95	3.75 95	3.75 95	3.00 76	3.75 95	3.75 95
DN65	3.000 76.1	3.75 95	—	—	—	3.75 95	3.75 95
3 DN80	3.500 88.9	4.25 108	4.25 108	4.25 108	3.25 83	4.25 108	6.00 152
3½ DN90	4.000 101.6	4.50 114	4.50 114	4.50 114	3.50 89	4.50 114	4.50 114
	4.250 108.0	5.00 127	—	—	—	5.00 127	5.00 127
4 DN100	4.500 114.3	5.00 127	5.00 127	5.00 127	3.75 95	5.00 127	7.25 184
4½	5.000 127.0	5.25 133	5.25 133	—	—	5.25 133	5.25 133
	5.250 133.0	5.50 140	—	—	—	5.50 140	5.50 140
DN125	5.500 139.7	5.50 140	—	—	—	5.50 140	5.50 140
5	5.563 141.3	5.50 140	5.50 140	5.50 140	4.00 102	5.50 140	5.50 140
	6.250 159.0	6.50 165	—	—	—	6.50 165	6.50 165
	6.500 165.1	6.50 165	6.50 165	—	—	6.50 165	6.50 165
6 DN150	6.625 168.3	6.50 165	6.50 165	6.50 165	4.50 114	6.50 165	6.50 165



For the most up-to-date dimensional information, always refer to the current Victaulic product publication, which can be downloaded at [victaulic.com](http://victaulic.com).



# FITTINGS FOR OGS GROOVED PIPE

No. 20 – Tee  
No. 35 – Cross

No. 33 – True Wye  
No. 29M – Tee with Threaded Branch

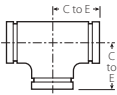

NO. 20



NO. 35

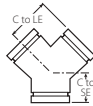

NO. 33

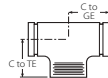

NO. 29M

Nominal Size inches/ DN	Actual Pipe Outside Diameter inches/ mm	No. 20	No. 35	No. 33		No. 29M	
		C to E inches/ mm	C to E inches/ mm	C to LE inches/ mm	C to SE inches/ mm	C to GE inches/ mm	C to TE inches/ mm
8 DN200	8.625 219.1	7.75 197	7.75 197	7.75 197	6.00 152	7.75 197	7.75 197
10 DN150	10.750 273.0	9.00 229	9.00 229	9.00 229	6.50 155	9.00 229	9.00 229
12 DN300	12.750 323.9	10.00 254	10.00 254	10.00 254	7.00 178	10.00 254	10.00 254
14 <sup>1</sup> DN350	14.000 355.6	11.00 279	11.00 279	11.00 279	7.50 191	—	—
	14.843 377.0	11.50 292	—	—	—	—	—
16 <sup>1</sup> DN400	16.000 406.4	12.00 305	12.00 305	12.00 305	8.00 203	—	—
	16.772 426.0	13.00 330	—	—	—	—	—
18 <sup>1</sup> DN450	18.000 457.2	15.50 394	15.50 394	15.50 394	8.50 216	—	—
	18.898 480.0	14.63 372	—	—	—	—	—
20 <sup>1</sup> DN500	20.000 508.0	17.25 438	17.25 438	17.25 438	9.00 229	—	—
	20.866 530.0	15.38 391	—	—	—	—	—
24 <sup>1</sup> DN600	24.000 609.6	20.00 508	20.00 508	20.00 508	10.00 254	—	—
	24.803 630.0	17.38 441	—	—	—	—	—

<sup>1</sup> For 14-inch/DN350 and larger roll groove systems, Victaulic offers the Advanced Groove System (AGS). Refer to publication 20.05. For pricing and availability of cut groove fittings in this size, contact your nearest Victaulic sales representative.



For the most up-to-date dimensional information, always refer to the current Victaulic product publication, which can be downloaded at [victaulic.com](http://victaulic.com).



# FITTINGS FOR OGS GROOVED PIPE

No. 25 – Reducing Tee with Grooved Branch

No. 29T – Reducing Tee with Threaded Branch

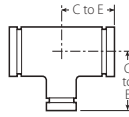

NO. 25

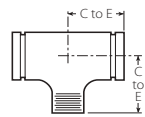

NO. 29T

Nominal Size inches/DN				No. 25	No. 29T	
				C to E inches/mm	C to E inches/mm	
1 DN25	×	1 DN25	×	3/4 DN20	2.25 57	2.25 57
1 1/4 DN32	×	1 1/4 DN32	×	1 DN25	2.75 70	2.75 70
1 1/2 DN40	×	1 1/2 DN40	×	3/4 DN20	2.75 70	2.75 70
				1 DN25	2.75 70	2.75 70
				1 1/4 DN32	2.75 70	2.75 70
2 DN50	×	2 DN50	×	3/4 DN20	3.25 83	3.25 83
				1 DN25	3.25 83	3.25 83
				1 1/4 DN32	3.25 83	3.25 83
				1 1/2 DN40	3.25 83	3.25 83
2 1/2	×	2 1/2	×	3/4 DN20	3.75 95	3.75 95
				1 DN25	3.75 95	3.75 95
				1 1/4 DN32	3.75 95	3.75 95
				1 1/2 DN40	3.75 95	3.75 95
				2 DN50	3.75 95	3.75 95
				2 1/2	3.75 95	3.75 95
3 DN80	×	3 DN80	×	3/4 DN20	4.25 108	4.25 108
				1 DN25	4.25 108	4.25 108
				1 1/4 DN32	4.25 108	4.25 108
				1 1/2 DN40	4.25 108	4.25 108
				2 DN50	4.25 108	4.25 108
				2 1/2	4.25 108	4.25 108
				3	4.25 108	4.25 108



For the most up-to-date dimensional information, always refer to the current Victaulic product publication, which can be downloaded at [victaulic.com](http://victaulic.com).



# FITTINGS FOR OGS GROOVED PIPE

No. 25 – Reducing Tee with Grooved Branch

No. 29T – Reducing Tee with Threaded Branch

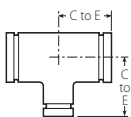

NO. 25

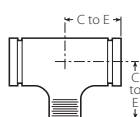

NO. 29T

Nominal Size inches/DN	No. 25		No. 29T	
	C to E inches/mm		C to E inches/mm	
4 DN100 × 4 DN100 ×	¾ DN20	5.00 127	5.00 127	5.00 127
	1 DN25	5.00 127	5.00 127	5.00 127
	1 ¼ DN32	5.00 127	5.00 127	5.00 127
	1 ½ DN40	5.00 127	5.00 127	5.00 127
	2 DN50	5.00 127	5.00 127	5.00 127
	2 ½ DN63	5.00 127	5.00 127	5.00 127
	3 DN80	5.00 127	5.00 127	5.00 127
	5 × 5 ×	1 DN25	5.50 140	5.50 140
1 ½ DN40		5.50 140	5.50 140	5.50 140
2 DN50		5.50 140	5.50 140	5.50 140
2 ½ DN63		5.50 140	5.50 140	5.50 140
3 DN80		5.50 140	5.50 140	5.50 140
4 DN100		5.50 140	5.50 140	5.50 140
6 DN150 × 6 DN150 ×		1 DN25	6.50 165	6.50 165
	1 ½ DN40	6.50 165	6.50 165	6.50 165
	2 DN50	6.50 165	6.50 165	6.50 165
	2 ½ DN63	6.50 165	6.50 165	6.50 165
	3 DN80	6.50 165	6.50 165	6.50 165
	4 DN100	6.50 165	6.50 165	6.50 165
	5 DN125	6.50 165	6.50 165	6.50 165



For the most up-to-date dimensional information, always refer to the current Victaulic product publication, which can be downloaded at [victaulic.com](http://victaulic.com).



# FITTINGS FOR OGS GROOVED PIPE

No. 25 – Reducing Tee with Grooved Branch

No. 29T – Reducing Tee with Threaded Branch

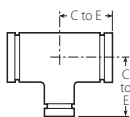

NO. 25

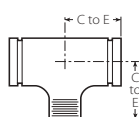

NO. 29T

Nominal Size inches/DN				No. 25	No. 29T	
				C to E inches/mm	C to E inches/mm	
6½ × 6½ ×	3 DN80	×	3	6.50	6.50	
				165	165	
6½ × 6½ ×	4 DN100	×	4	6.50	6.50	
				165	165	
8 DN200 × 8 DN200 ×	1½ DN40	×	1½	7.75	7.75	
				197	197	
				2 DN50	7.75	7.75
					197	197
				2½	7.75	7.75
					197	197
				3 DN80	7.75	7.75
					197	197
				4 DN100	7.75	7.75
					197	197
5	7.75	7.75				
	197	197				
6 DN150	7.75	7.75				
	197	197				
165.1mm	7.75	7.75				
	197	197				
10 DN250 × 10 DN250 ×	1½ DN40	×	1½	9.00	9.00	
				229	229	
				2 DN50	9.00	9.00
					229	229
				2½	9.00	9.00
					229	229
				3 DN80	9.00	9.00
					229	229
				4 DN100	9.00	9.00
					229	229
5	9.00	9.00				
	229	229				
6 DN150	9.00	9.00				
	229	229				
8 DN200	9.00	9.00				
	229	229				



For the most up-to-date dimensional information, always refer to the current Victaulic product publication, which can be downloaded at [victaulic.com](http://victaulic.com).



# FITTINGS FOR OGS GROOVED PIPE

No. 25 – Reducing Tee with Grooved Branch

No. 29T – Reducing Tee with Threaded Branch

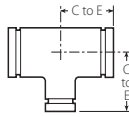

NO. 25

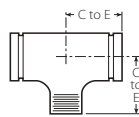

NO. 29T

Nominal Size inches/DN			No. 25	No. 29T						
			C to E inches/mm	C to E inches/mm						
12 DN300	×	12 DN300	×	1 DN25	10.00 254	10.00 254				
				2 DN50	10.00 254	10.00 254				
				2½	10.00 254	10.00 254				
				3 DN80	10.00 254	10.00 254				
				4 DN100	10.00 254	10.00 254				
				5	10.00 254	10.00 254				
				6 DN150	10.00 254	10.00 254				
				8 DN200	10.00 254	10.00 254				
				10 DN250	10.00 254	10.00 254				
				14 <sup>1</sup> DN350	×	14 DN350	×	4 DN100	11.00 279	11.00 279
								6 DN150	11.00 279	11.00 279
8 DN200	11.00 279	11.00 279								
10 DN250	11.00 279	11.00 279								
12 DN300	11.00 279	11.00 279								
16 <sup>1</sup> DN400	×	16 DN400	×					4 DN100	12.00 305	12.00 305
				6 DN150	12.00 305	12.00 305				
				8 DN200	12.00 305	12.00 305				
				10 DN250	12.00 305	12.00 305				
				12 DN300	12.00 305	12.00 305				
				14 DN350	12.00 305	—				



For the most up-to-date dimensional information, always refer to the current Victaulic product publication, which can be downloaded at [victaulic.com](http://victaulic.com).

# FITTINGS FOR OGS GROOVED PIPE

No. 25 – Reducing Tee with Grooved Branch

No. 29T – Reducing Tee with Threaded Branch

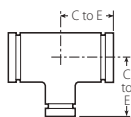

NO. 25

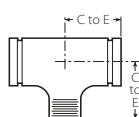

NO. 29T

Nominal Size inches/DN			No. 25	No. 29T			
			C to E inches/mm	C to E inches/mm			
18 <sup>1</sup> DN450	×	18 DN450	×	4 DN100	15.50 394	15.50 394	
					6 DN150	15.50 394	15.50 394
					8 DN200	15.50 394	15.50 394
					10 DN250	15.50 394	15.50 394
					12 DN300	15.50 394	15.50 394
					14 DN350	15.50 394	—
					16 DN400	15.50 394	—
					20 <sup>1</sup> DN500	×	20 DN500
8 DN200	17.25 438	17.25 438					
10 DN250	17.25 438	17.25 438					
12 DN300	17.25 438	17.25 438					
14 DN350	17.25 438	—					
16 DN400	17.25 438	—					
18 DN450	17.25 438	—					



For the most up-to-date dimensional information, always refer to the current Victaulic product publication, which can be downloaded at [victaulic.com](http://victaulic.com).



# FITTINGS FOR OGS GROOVED PIPE

No. 25 – Reducing Tee with Grooved Branch

No. 29T – Reducing Tee with Threaded Branch

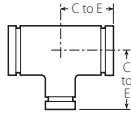

NO. 25

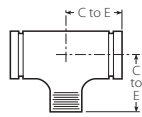

NO. 29T

Nominal Size inches/DN	No. 25	No. 29T
	C to E inches/mm	C to E inches/mm
24 <sup>1</sup> DN600 × 24 DN600 × 8 DN200	20.00 508	20.00 508
10 DN250	20.00 508	20.00 508
12 DN300	20.00 508	20.00 508
14 DN350	20.00 508	—
16 DN400	20.00 508	—
18 DN450	20.00 508	—
20 DN500	20.00 508	—

<sup>1</sup> For 14-inch/DN350 and larger roll groove systems, Victaulic offers the Advanced Groove System (AGS). Refer to publication 20.05. For pricing and availability of cut groove fittings in this size, contact your nearest Victaulic sales representative.



For the most up-to-date dimensional information, always refer to the current Victaulic product publication, which can be downloaded at [victaulic.com](http://victaulic.com).

# FITTINGS FOR OGS GROOVED PIPE

## No. L25 Reducing Tee

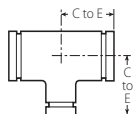

NO. L25

Nominal Size inches/DN				C to E (Run) inches/mm	C to E (Branch) inches/mm
2 DN50	×	2 DN50	×	1½ DN40	3.00 76
3 DN80	×	3 DN80	×	1½ DN40	4.00 102
				2 DN50	4.00 102
4 DN100	×	4 DN100	×	1½ DN40	4.00 102
				2 DN50	4.00 102
				2½	5.00 127
				3 DN80	5.00 127
6 DN150	×	6 DN150	×	2 DN50	5.50 140
				3 DN80	6.00 152
				4 DN100	6.00 152
8 DN200	×	8 DN200	×	2 DN50	6.50 165
				2½	7.25 184
				3 DN80	7.25 184
				4 DN100	7.25 184
				6 DN150	7.50 191
				10 DN250	×
12 DN300	×	12 DN300	×	8 DN200	11.25 286
				10 DN250	11.75 298



For the most up-to-date dimensional information, always refer to the current Victaulic product publication, which can be downloaded at [victaulic.com](http://victaulic.com).



# FITTINGS FOR OGS GROOVED PIPE

## No. 61 – Bull Plug

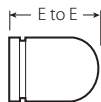

NO. 61

Nominal Size inches/DN	Actual Pipe Outside Diameter inches/mm	E to E inches/mm
2 DN50	2.375 60.3	4.00 102
2½	2.875 73.0	5.00 127
3 DN80	3.500 88.9	6.00 152
4 DN100	4.500 114.3	7.00 178
5	5.563 141.3	8.00 203
6 DN150	6.625 168.3	10.00 254



For the most up-to-date dimensional information, always refer to the current Victaulic product publication, which can be downloaded at [victaulic.com](http://victaulic.com).

# FITTINGS FOR OGS GROOVED PIPE

## No. 30 – 45° Lateral

Nominal Size inches/DN	Actual Pipe Outside Diameter inches/mm	C to LE inches/mm	C to SE inches/mm
¾ DN20	1.050 26.9	4.50 114	2.00 51
1 DN25	1.315 33.7	5.00 127	2.25 57
1¼ DN32	1.660 42.4	5.75 146	2.50 64
1½ DN40	1.900 48.3	6.25 159	2.75 70
2 DN50	2.375 60.3	7.00 178	2.75 70
2½ DN65	2.875 73.0	7.75 197	3.00 76
	3.000 76.1	8.50 216	3.25 83
3 DN80	3.500 88.9	8.50 216	3.25 83
3½ DN90	4.000 101.6	10.00 254	3.50 89
4 DN100	4.500 114.3	10.50 267	3.75 95
5	5.563 141.3	12.50 318	4.00 102
	6.500 165.1	14.00 356	4.50 114
6 DN150	6.625 168.3	14.00 356	4.50 114
8 DN200	8.625 219.1	18.00 457	6.00 152
10 DN250	10.750 273.0	20.50 521	6.50 165
12 DN300	12.750 323.9	23.00 584	7.00 178
14 <sup>1</sup> DN350	14.000 355.6	26.50 673	7.50 191
16 <sup>1</sup> DN400	16.000 406.4	29.00 737	8.00 203
18 <sup>1</sup> DN450	18.000 457.2	32.00 813	8.50 216
20 <sup>1</sup> DN500	20.000 508.0	35.00 889	9.00 229
24 <sup>1</sup> DN600	24.000 609.6	40.00 1016	10.00 254

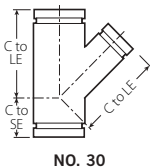

<sup>1</sup> For 14-inch/DN350 and larger roll groove systems, Victaulic offers the Advanced Groove System (AGS). Refer to publication 20.05. For pricing and availability of cut groove fittings in this size, contact your nearest Victaulic sales representative.



For the most up-to-date dimensional information, always refer to the current Victaulic product publication, which can be downloaded at [victaulic.com](http://victaulic.com).



# FITTINGS FOR OGS GROOVED PIPE

## No. 30-R – 45° Reducing Lateral

Nominal Size inches/DN			C to LE inches/mm	C to SE inches/mm		
3 DN80	x	3 DN80	x	2 DN50	8.50 216	3.25 83
					2½	8.50 216
4 DN100	x	4 DN100	x	2 DN50	10.50 267	3.75 95
					2½	10.50 267
				3 DN80	10.50 267	3.75 95
5	x	5	x	2 DN50	12.50 318	4.00 102
					3 DN80	12.50 318
				4 DN100	12.50 318	4.00 102
6 DN150	x	6 DN150	x	3 DN80	14.00 356	4.50 114
					4 DN100	14.00 356
				5	14.00 356	4.50 114
8 DN200	x	8 DN200	x	4 DN100	18.00 457	6.00 152
					5	18.00 457
				6 DN150	18.00 457	6.00 152
10 DN250	x	10 DN250	x	4 DN100	20.50 521	6.50 165
					5	20.50 521
				6 DN150	20.50 521	6.50 165
				8 DN200	20.50 521	6.50 165
12 DN300	x	12 DN300	x	5	23.00 584	7.00 178
					6 DN150	23.00 584
				8 DN200	23.00 584	7.00 178
				10 DN250	23.00 584	7.00 178

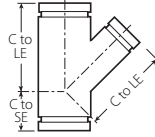

NO. 30-R



For the most up-to-date dimensional information, always refer to the current Victaulic product publication, which can be downloaded at [victaulic.com](http://victaulic.com).

# FITTINGS FOR OGS GROOVED PIPE

## No. 30-R – 45° Reducing Lateral

Nominal Size inches/DN			C to LE inches/mm	C to SE inches/mm	
14 <sup>1</sup> DN350	x	14 DN350	4 DN100	26.50 673	7.50 191
		6 DN150		26.50 673	7.50 191
		8 DN200		26.50 673	7.50 191
		10 DN250		26.50 673	7.50 191
		12 DN300		26.50 673	7.50 191
		16 <sup>1</sup> DN400		x	16 DN400
8 DN200	29.00 737	8.00 203			
10 DN250	29.00 737	8.00 203			
12 DN300	29.00 737	8.00 203			
14 DN350	29.00 737	8.00 203			
18 <sup>1</sup> DN450	x	18 DN450	6 DN150		32.00 813
8 DN200		32.00 813		8.50 216	
12 DN300		32.00 813		8.50 216	
14 DN350		32.00 813		8.50 216	
16 DN400		32.00 813		8.50 216	
20 <sup>1</sup> DN500		x		20 DN500	12 DN300
14 DN350	35.00 889		9.00 229		
16 DN400	35.00 889		10.00 229		
24 <sup>1</sup> DN600	x	24 DN600	16 DN400	40.00 1016	10.00 254
		20 DN500		40.00 1016	10.00 254

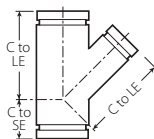

NO. 30-R

<sup>1</sup>For 14-inch/DN350 and larger roll groove systems, Victaulic offers the Advanced Groove System (AGS). Refer to publication 20.05. For pricing and availability of cut groove fittings in this size, contact your nearest Victaulic sales representative.



For the most up-to-date dimensional information, always refer to the current Victaulic product publication, which can be downloaded at [victaulic.com](http://victaulic.com).



# FITTINGS FOR OGS GROOVED PIPE

## No. 32 – Tee Wye

Nominal Size inches/DN	G inches/ mm	H inches/ mm	E <sup>1</sup> inches/ mm	E <sup>2</sup> inches/ mm
2 DN50 × 2 DN50 × 2 DN50	2.75 70	7.00 178	9.00 229	4.63 118
2½ × 2½ × 2½	3.00 76	7.75 197	10.50 267	5.75 146
3 DN80 × 3 DN80 × 3 DN80	3.25 83	8.50 216	11.50 292	6.50 165
3½ DN90 × 3½ DN90 × 3½ DN90	3.50 89	10.00 254	13.00 330	7.75 197
4 DN100 × 4 DN100 × 4 DN100	3.75 95	10.50 267	13.63 346	8.13 207
5 × 5 × 5	4.00 102	12.50 318	16.13 410	10.00 254
6 DN150 × 6 DN150 × 6 DN150	4.50 114	14.00 356	18.25 464	11.50 292
8 DN200 × 8 DN200 × 8 DN200	6.00 152	18.00 457	23.25 591	15.25 387
10 DN250 × 10 DN250 × 10 DN250	6.50 165	20.50 521	27.25 692	18.00 457
12 DN300 × 12 DN300 × 12 DN300	7.00 178	23.00 584	31.00 787	20.50 521

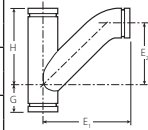

NO. 32



For the most up-to-date dimensional information, always refer to the current Victaulic product publication, which can be downloaded at [victaulic.com](http://victaulic.com).

# FITTINGS FOR OGS GROOVED PIPE

No. 40 – Grooved x Threaded Adapter Nipple

No. 42 – Grooved x Beveled Adapter Nipple

No. 43 – Grooved x Grooved Adapter Nipple

Nominal Size inches/DN	Actual Pipe Outside Diameter inches/mm	E to E inches/mm
¾ DN20	1.050 26.9	3.00 76
1 DN25	1.315 33.7	3.00 76
1¼ DN32	1.660 42.4	4.00 102
1½ DN40	1.900 48.3	4.00 102
2 DN50	2.375 60.3	4.00 102
2½	2.875 73.0	4.00 102
3 DN80	3.500 88.9	4.00 102
3½ DN90	4.000 101.6	4.00 102
4 DN100	4.500 114.3	6.00 152
5	5.563 141.3	6.00 152
6 DN150	6.625 168.3	6.00 152
8 DN200	8.625 219.1	6.00 152
10 DN250	10.750 273.0	8.00 203
12 DN300	12.750 323.9	8.00 203



NO. 40



NO. 42



NO. 43



For the most up-to-date dimensional information, always refer to the current Victaulic product publication, which can be downloaded at [victaulic.com](http://victaulic.com).



# FITTINGS FOR OGS GROOVED PIPE

## No. 60/L60 – Cap

Nominal Size inches/DN	Actual Pipe Outside Diameter inches/mm	No. 60	No. L60
		Thickness inches/mm	Thickness inches/mm
¾ DN20	1.050 26.9	0.88 22.4	—
1 DN25	1.315 33.7	0.88 22.4	—
1 ¼ DN32	1.660 42.4	0.88 22.4	—
1 ½ DN40	1.900 48.3	0.88 22.4	0.82 20.8
2 DN50	2.375 60.3	0.88 22.4	0.88 22.4
2 ½	2.875 73.0	0.88 22.4	—
DN65	3.000 76.1	0.88 22.4	—
3 DN80	3.500 88.9	0.88 22.4	0.88 22.4
3 ½ DN90	4.000 101.6	0.88 22.4	—
	4.250 108.0	1.00 25	—
4 DN100	4.500 114.3	1.00 25	1.00 25.4
	5.250 133.0	1.00 25	—
DN125	5.500 139.7	1.00 25	—
5	5.563 141.3	1.00 25	—
	6.250 159.0	1.00 25	—
	6.500 165.1	1.00 25	—
6 DN150	6.625 168.3	1.00 25	1.00 25.4
8 DN200	8.625 219.1	1.19 30	1.13 28.7
10 DN250	10.750 273.0	1.25 32	1.06 26.9
12 DN300	12.750 323.9	1.25 32	1.25 31.8
14 <sup>1</sup> DN350	14.000 355.6	9.50 241	—
16 <sup>1</sup> DN400	16.000 406.4	10.00 254	—
18 <sup>1</sup> DN450	18.000 457.2	11.00 279	—
20 <sup>1</sup> DN500	20.000 508.0	12.00 305	—
24 <sup>1</sup> DN600	24.000 609.6	13.50 343	—

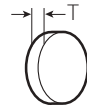

NO. 60/L60

<sup>1</sup> For 14-inch/DN350 and larger roll groove systems, Victaulic offers the Advanced Groove System (AGS). Refer to publication 20.05. For pricing and availability of cut groove fittings in this size, contact your nearest Victaulic sales representative.

**NOTE:** End caps are available with an NPT or BSPT tapped port. For more information, contact Victaulic.



For the most up-to-date dimensional information, always refer to the current Victaulic product publication, which can be downloaded at [victaulic.com](http://victaulic.com).

# FITTINGS FOR OGS GROOVED PIPE

- No. 41 – ANSI Class 125 Flanged Adapter Nipple
- No. 45F – ANSI Class 150 Flat-Face Flanged Adapter Nipple
- No. 45R – ANSI Class 150 Raised-Face Flanged Adapter Nipple
- No. L45R – Flange Adapter Nipple 150# – Raised Face
- No. 46F – ANSI Class 300 Flat-Face Flanged Adapter Nipple
- No. 46R – ANSI Class 300 Raised-Face Flanged Adapter Nipple
- No. L46R – Flange Adapter Nipple 300# – Raised Face
- No. 45RE – PN10/PN16 Raised-Face Flanged Adapter Nipple

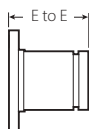

No. 41, 45F,  
46F

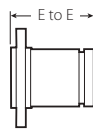

No. 45R, L45R, 46R,  
L46R, 45RE

Nominal Size inches/DN	Actual Pipe Outside Diameter inches/mm	No. 41	No. 45F, 45R, L45R	No. 46F, 46R, L46R	No. 45RE
		E to E inches/mm	E to E inches/mm	E to E inches/mm	E to E inches/mm
3/4 DN20	1.050 26.9	3.00 76	3.00 76	3.00 76	—
1 DN25	1.315 33.7	3.00 76	3.00 76	3.00 76	—
1 1/4 DN32	1.660 42.4	4.00 102	4.00 102	4.00 102	—
1 1/2 DN40	1.900 48.3	4.00 102	4.00 102	4.00 102	—
2 DN50	2.375 60.3	4.00 102	4.00 102	4.00 102	2.50 64
2 1/2 DN65	2.875 73.0	4.00 102	4.00 102	4.00 102	—
3 DN80	3.000 76.1	—	—	—	2.50 64
3 1/2 DN90	3.500 88.9	4.00 102	4.00 102	4.00 102	2.50 64
4 DN100	4.000 101.6	4.00 102	4.00 102	4.00 102	—
5 DN150	4.500 114.3	6.00 152	6.00 152	6.00 152	2.75 70
6 DN200	5.563 141.3	6.00 152	6.00 152	6.00 152	2.75 70
8 DN250	6.625 168.3	6.00 152	6.00 152	6.00 152	2.75 70
10 DN300	8.625 219.1	6.00 152	6.00 152	6.00 152	—
12 DN350	10.750 273.0	8.00 203	8.00 203	8.00 203	—
14 <sup>1</sup> DN350	12.750 323.9	8.00 203	8.00 203	8.00 203	—
14 <sup>1</sup> DN350	14.000 355.6	8.00 203	8.00 203	8.00 203	—



For the most up-to-date dimensional information, always refer to the current Victaulic product publication, which can be downloaded at [victaulic.com](http://victaulic.com).



# FITTINGS FOR OGS GROOVED PIPE

No. 41 – ANSI Class 125 Flanged Adapter Nipple

No. 45F – ANSI Class 150 Flat-Face Flanged Adapter Nipple

No. 45R – ANSI Class 150 Raised-Face Flanged Adapter Nipple

No. L45R – Flange Adapter Nipple 150# – Raised Face

No. 46F – ANSI Class 300 Flat-Face Flanged Adapter Nipple

No. 46R – ANSI Class 300 Raised-Face Flanged Adapter Nipple

No. L46R – Flange Adapter Nipple 300# – Raised Face

No. 45RE – PN10/PN16 Raised-Face Flanged Adapter Nipple

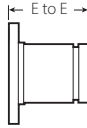

No. 41, 45F,  
46F

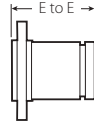

No. 45R, L45R, 46R,  
L46R, 45RE

Nominal Size inches/DN	Actual Pipe Outside Diameter inches/mm	No. 41	No. 45F, 45R, L45R	No. 46F, 46R, L46R	No. 45RE
		E to E inches/mm	E to E inches/mm	E to E inches/mm	E to E inches/mm
16 <sup>1</sup> DN400	16.000 406.4	8.00 203	8.00 203	8.00 203	—
18 <sup>1</sup> DN450	18.000 457.2	8.00 203	8.00 203	8.00 203	—
20 <sup>1</sup> DN500	20.000 508.0	8.00 203	8.00 203	8.00 203	—
24 <sup>1</sup> DN600	24.000 609.6	8.00 203	8.00 203	8.00 203	—

<sup>1</sup> For 14-inch/DN350 and larger roll groove systems, Victaulic offers the Advanced Groove System (AGS). Refer to publication 20.05. For pricing and availability of cut groove fittings in this size, contact your nearest Victaulic sales representative.



For the most up-to-date dimensional information, always refer to the current Victaulic product publication, which can be downloaded at [victaulic.com](http://victaulic.com).

# FITTINGS FOR OGS GROOVED PIPE

No. 53 – Grooved x Grooved Swaged Nipple

No. 54 – Grooved x Threaded Swaged Nipple

No. 55 – Threaded x Grooved Swaged Nipple

Nominal Size inches/DN		E to E inches/mm			
2 DN50	×	1 DN25	6.50 165		
		1 ¼ DN32	6.50 165		
		1 ½ DN40	6.50 165		
		2 DN50	7.00 178		
2 ½	×	1 DN25	7.00 178		
		1 ¼ DN32	7.00 178		
		1 ½ DN40	7.00 178		
		2 DN50	7.00 178		
3 DN80	×	1 DN25	8.00 203		
		1 ¼ DN32	8.00 203		
		1 ½ DN40	8.00 203		
		2 DN50	8.00 203		
		2 ½	8.00 203		
		3 DN80	8.00 203		
		3 ½ DN90	8.00 203		
4 DN100	×	1 DN25	9.00 229		
		1 ¼ DN32	9.00 229		
		1 ½ DN40	9.00 229		
		2 DN50	9.00 229		
		2 ½	9.00 229		
		3 DN80	9.00 229		
		3 ½ DN90	9.00 229		
		5	×	2 DN50	11.00 279
				3 DN80	11.00 279
				4 DN100	11.00 279

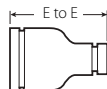

NO. 53

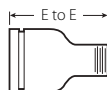

NO. 54



NO. 55



For the most up-to-date dimensional information, always refer to the current Victaulic product publication, which can be downloaded at [victaulic.com](http://victaulic.com).



# FITTINGS FOR OGS GROOVED PIPE

No. 53 – Grooved x Grooved Swaged Nipple

No. 54 – Grooved x Threaded Swaged Nipple

No. 55 – Threaded x Grooved Swaged Nipples

Nominal Size inches/DN		E to E inches/mm
6 DN150	1 DN25	12.00 305
	1 ¼ DN32	12.00 305
	1 ½ DN40	12.00 305
	2 DN50	12.00 305
	2 ½	12.00 305
	3 DN80	12.00 305
	3 ½ DN90	12.00 305
	4 DN100	12.00 305
	4 ½	12.00 305
	5	12.00 305

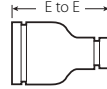

NO. 53

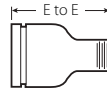

NO. 54

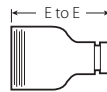

NO. 55

No. 80 – Female Threaded Adapter

Nominal Size inches/DN	Actual Pipe Outside Diameter inches/mm	E to E inches/mm
¾ DN20	1.050 26.9	2.00 51
1 DN25	1.315 33.7	2.06 52
1 ¼ DN32	1.660 42.4	2.31 (sw) 59
1 ½ DN40	1.900 48.3	2.31 (sw) 59
2 DN50	2.375 60.3	2.50 64
2 ½	2.875 73.0	2.75 70
3 DN80	3.500 88.9	2.75 70
4 DN100	4.500 114.3	3.25 83

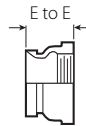

NO. 80



For the most up-to-date dimensional information, always refer to the current Victaulic product publication, which can be downloaded at [victaulic.com](http://victaulic.com).

# FITTINGS FOR OGS GROOVED PIPE

## No. 48 – Hose Nipple

Nominal Size inches/DN	Actual Pipe Outside Diameter inches/mm	E to E inches/mm
¾ DN20	1.050 26.9	3.12 79
1 DN25	1.315 33.7	3.38 86
1 ¼ DN32	1.660 42.4	3.88 98
1 ½ DN40	1.900 48.3	3.88 98
2 DN50	2.375 60.3	4.50 114
2 ½	2.875 73.0	5.38 137
3 DN80	3.500 88.9	5.75 146
4 DN100	4.500 114.3	7.00 178
5	5.563 141.3	8.75 222
6 DN150	6.625 168.3	10.13 257
8 DN200	8.625 219.1	11.88 302
10 DN250	10.750 273.0	12.50 318
12 DN300	12.750 323.9	14.50 368

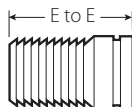

NO. 48



For the most up-to-date dimensional information, always refer to the current Victaulic product publication, which can be downloaded at [victaulic.com](http://victaulic.com).



# FITTINGS FOR OGS GROOVED PIPE

## No. 50 – Concentric Reducer

## No. 51 – Eccentric Reducer

Nominal Size inches/DN	No. 50		No. 51	
		E to E inches/mm		E to E inches/mm
1 ½ DN40 ×	1 DN25	2.50 64	8.50 216	
	1 ¼ DN32	2.50 64	—	
2 DN50 ×	¾ DN20	2.50 64	9.00 229	
	1 DN25	2.50 64	9.00 229	
	1 ¼ DN32	2.50 64	9.00 229	
	1 ½ DN40	2.50 64	3.50 89	
	2 DN50	2.50 64	3.50 89	
2 ½ ×	1 DN25	2.50 64	9.50 241	
	1 ¼ DN32	3.50 89	3.50 89	
	1 ½ DN40	2.50 64	9.50 241	
	2 DN50	2.50 64	3.50 89	
	2 ½ DN50	2.50 64	3.50 89	
3 DN80 ×	1 DN25	2.50 64	9.50 241	
	1 ¼ DN32	2.50 64	—	
	1 ½ DN40	2.50 64	9.50 241	
	2 DN50	2.50 64	3.50 89	
	2 ½ DN50	2.50 64	3.50 89	
	2 ½ DN50	2.50 64	3.50 89	
	DN65	2.50 64	—	
3 ½ DN90 ×	3 DN80	2.50 64	9.50 241	
4 DN100 ×	1 DN25	3.00 76	13.00 330	
	1 ½ DN40	3.00 76	10.00 254	
	2 DN50	3.00 76	4.00 102	
	2 ½ DN50	3.00 76	4.00 102	
	3 DN80	3.00 76	4.00 102	
	3 ½ DN90	3.00 76	10.00 254	
	3 ½ DN90	3.00 76	10.00 254	



NO. 50



NO. 51



For the most up-to-date dimensional information, always refer to the current Victaulic product publication, which can be downloaded at [victaulic.com](http://victaulic.com).

# FITTINGS FOR OGS GROOVED PIPE

No. 50 – Concentric Reducer

No. 51 – Eccentric Reducer

Nominal Size inches/DN		No. 50	No. 51
		E to E inches/mm	E to E inches/mm
5	× DN50	2	11.00
		2½	11.00
		3	11.00
		4	5.00
6	× DN150	1	11.50
		2	11.50
		2½	11.50
		3	5.50
		4	5.50
		5	5.50
8	× DN200	2½	12.00
		3	12.00
		4	12.00
		5	12.00
		6	6.00
10	× DN250	4	13.00
		6	13.00
		8	7.00
		6	14.00
		8	14.00
		10	14.00



NO. 50

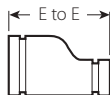

NO. 51



For the most up-to-date dimensional information, always refer to the current Victaulic product publication, which can be downloaded at [victaulic.com](http://victaulic.com).



# FITTINGS FOR OGS GROOVED PIPE

## No. 50 – Concentric Reducer

## No. 51 – Eccentric Reducer

Nominal Size inches/DN	No. 50	No. 51
	E to E inches/mm	E to E inches/mm
14 <sup>1</sup> DN350 × DN150	6 13.00 330	13.00 330
	8 13.00 330	13.00 330
	10 13.00 330	13.00 330
	12 13.00 330	13.00 330
	12 13.00 330	13.00 330
16 <sup>1</sup> DN400 × DN200	8 14.00 356	14.00 355
	10 14.00 356	14.00 355
	12 14.00 356	14.00 355
	14 14.00 356	14.00 355
	14 14.00 356	14.00 355
18 <sup>1</sup> DN450 × DN250	10 15.00 381	15.00 381
	12 15.00 381	15.00 381
	14 15.00 381	15.00 381
	16 15.00 381	15.00 381
	16 15.00 381	15.00 381
20 <sup>1</sup> DN500 × DN250	10 20.00 508	20.00 508
	12 20.00 508	20.00 508
	14 20.00 508	20.00 508
	16 20.00 508	20.00 508
	18 20.00 508	20.00 508
	18 20.00 508	20.00 508
24 <sup>1</sup> DN600 × DN250	10 20.00 508	20.00 508
	12 20.00 508	20.00 508
	14 20.00 508	20.00 508
	16 20.00 508	20.00 508
	18 20.00 508	20.00 508
	18 20.00 508	20.00 508
	20 20.00 508	20.00 508
	20 20.00 508	20.00 508



NO. 50

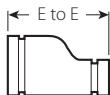

NO. 51

<sup>1</sup> For 14-inch/DN350 and larger roll groove systems, Victaulic offers the Advanced Groove System (AGS). Refer to publication 20.05. For pricing and availability of cut groove fittings in this size, contact your nearest Victaulic sales representative.



For the most up-to-date dimensional information, always refer to the current Victaulic product publication, which can be downloaded at [victaulic.com](http://victaulic.com).

# FITTINGS FOR OGS GROOVED PIPE

No. 52 – Concentric Reducer with Threaded End

No. 52F – Concentric Reducer with BSPT Female Threaded End

Nominal Size inches/DN		No. 52	No. 52F
		E to E inches/mm	E to E inches/mm
1 ½ DN40	× 1 DN25	2.50 64	—
	1 ¼ DN32	2.50 64	—
2 DN50	× ¾ DN20	2.50 64	—
	1 DN25	2.50 64	—
	1 ¼ DN32	2.50 64	—
	1 ½ DN40	2.50 64	—
2 ½	× 1 DN25	2.50 64	—
	1 ¼ DN32	2.50 64	—
	1 ½ DN40	2.50 64	—
	2 DN50	2.50 64	—
DN65	× 1 ½ DN40	2.50 64	2.50 64
	2 DN50	—	2.50 64
3 DN80	× 1 DN25	2.50 64	—
	1 ¼ DN32	2.50 64	—
	1 ½ DN40	2.50 64	—
	2 DN50	2.50 64	—
	2 ½	2.50 64	—
88.9 mm	× 42.4 mm	2.50 64	2.50 64
	48.3 mm	2.50 64	2.50 64
	60 mm	—	2.50 64



NO. 52



NO. 52F



For the most up-to-date dimensional information, always refer to the current Victaulic product publication, which can be downloaded at [victaulic.com](http://victaulic.com).



# FITTINGS FOR OGS GROOVED PIPE

No. 52 – Concentric Reducer with Threaded End

No. 52F – Concentric Reducer with BSPT Female Threaded End

Nominal Size inches/DN		No. 52	No. 52F
		E to E inches/mm	E to E inches/mm
4 DN100	1 DN25	3.00 76	—
	1 ½ DN40	3.00 76	—
	2 DN50	3.00 76	—
	2 ½	3.00 76	—
	3 DN80	3.00 76	—
108.4 mm ×	42.4 mm	3.00 76	3.00 76
	48.3 mm	3.00 76	3.00 76
	60 mm	—	3.00 76
114.3 mm ×	42.4 mm	3.00 76	3.00 76
	48.3 mm	3.00 76	3.00 76
	60 mm	3.00 76	3.00 76
133.0 mm ×	60 mm	—	4.50 114
139.0 mm ×	60 mm	—	4.50 114
6 DN150	1 DN25	4.00 102	—
	2 DN50	4.00 102	—
	2 ½	4.00 102	—
	3 DN80	4.00 102	—
159.0 mm ×	42.2 mm	4.50 114	4.50 114
	48.3 mm	4.50 114	4.50 114
	60 mm	—	4.50 114
165.3 mm ×	42.4 mm	4.00 102	4.00 102
	48.3 mm	4.00 102	4.00 102
	60 mm	—	4.00 102
8 DN200	2 DN50	16.00 406	—
	2 ½	16.00 406	4.50 114



NO. 52



NO. 52F



For the most up-to-date dimensional information, always refer to the current Victaulic product publication, which can be downloaded at [victaulic.com](http://victaulic.com).

# FITTINGS FOR OGS GROOVED PIPE

## No. L50 – Concentric Reducer

Nominal Size inches/DN			E to E inches/mm
2 DN50	×	1 ½ DN40	3.00 76
3 DN80	×	1 ½ DN40	3.50 89
		2 DN50	3.50 89
4 DN100	×	1 ½ DN40	4.00 102
		2 DN50	4.00 102
		2 ½	4.00 102
		3 DN80	4.00 102
6 DN150	×	2 DN50	5.50 140
		3 DN80	5.50 140
		4 DN100	5.50 140
8 DN200	×	4 DN100	6.00 152
		6 DN150	6.00 152
10 DN250	×	4 DN100	7.00 178
		6 DN150	7.00 178
		8 DN200	7.00 178
12 DN300	×	8 DN200	8.00 203
		10 DN250	8.00 203

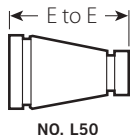

For the most up-to-date dimensional information, always refer to the current Victaulic product publication, which can be downloaded at [victaulic.com](http://victaulic.com).



# FITTINGS FOR OGS GROOVED PIPE

## No. L51 – Eccentric Reducer

Nominal Size inches/DN			E to E inches/mm
2 DN50	×	1 ½ DN40	3.00 76
3 DN80	×	1 ½ DN40	3.50 89
		2 DN50	3.50 89
4 DN100	×	1 ½ DN40	4.00 102
		2 DN50	4.00 102
		2 ½	4.00 102
		3 DN80	4.00 102
6 DN150	×	2 DN50	5.50 140
		3 DN80	5.50 140
		4 DN100	5.50 140
8 DN200	×	4 DN100	6.00 152
		6 DN150	6.00 152
10 DN250	×	4 DN100	7.00 178
		6 DN150	7.00 178
		8 DN200	7.00 178
12 DN300	×	8 DN200	8.00 203
		10 DN250	8.00 203

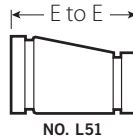

## No. L52 – Threaded Reducer (Female - NPT)

Nominal Size inches/DN			E to E inches/mm
1 ½ DN40	×	¾ DN20	2.50 64
		1 DN25	2.50 63.5
2 DN50	×	¾ DN20	2.50 64
		1 DN25	2.50 64
		1 ½ DN40	2.50 64

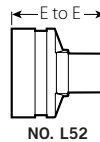

For the most up-to-date dimensional information, always refer to the current Victaulic product publication, which can be downloaded at [victaulic.com](http://victaulic.com).

# FITTINGS FOR OGS GROOVED PIPE

## No. 445F/445R – Flange Adapter Nipple

Nominal Size inches/DN	Actual Pipe Outside Diameter inches/mm	E to E inches/mm
1 ¼ DN32	1.660 42.2	4.00 102
1 ½ DN40	1.900 48.3	4.00 102
2 DN50	2.375 60.3	4.00 102
2 ½	2.875 73.0	4.00 102
DN65	3.000 76.1	4.00 102
3 DN80	3.500 88.9	4.00 102
4 DN100	4.500 114.3	6.00 152
5	5.563 141.3	6.00 152
6 DN150	6.625 168.3	6.00 152
8 DN200	8.625 219.1	6.00 152
10 DN250	10.750 273.0	8.00 203
12 DN300	12.750 323.9	8.00 203

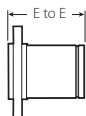

NO. 445F/445R

## No. 441N (PN10/PN16) – ISO Flange Adapter Nipple

Nominal Size DN/inches	Actual Pipe Outside Diameter mm/inches	E to E mm/inches
DN50 2	60.3 2.375	64 2.50
2 ½	73.0 2.875	64 2.50
DN65	76.1 3.000	64 2.50
DN80 3	88.9 3.500	64 2.50
DN100 4	114.3 4.500	76 3.00
DN150 6	168.3 6.625	89 3.50
DN200 8	219.1 8.625	102 4.00
DN250 10	273.0 10.750	127 5.00
DN300 12	323.9 12.750	152 5.98

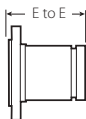

NO. 441N



For the most up-to-date dimensional information, always refer to the current Victaulic product publication, which can be downloaded at [victaulic.com](http://victaulic.com).



# ENDSEAL™ EXTRA HEAVY “ES” FITTINGS

No. 62-ES – 90° Elbow

No. 63-ES – 45° Elbow

No. 64-ES – Tee

No. 35-ES – Cross

No. 60-ES – End Cap

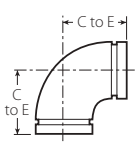

NO. 62-ES

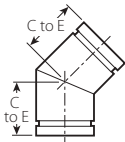

NO. 63-ES

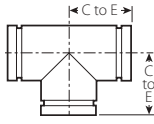

NO. 64-ES

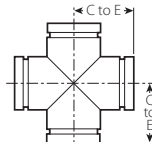

NO. 35-ES



NO. 60-ES

Nominal Size inches/DN	Actual Pipe Outside Diameter inches/ mm	No. 62-ES	No. 63-ES	No. 64-ES	No. 35-ES	No. 60-ES
		C to E inches/ mm	C to E inches/ mm	C to E inches/ mm	C to E inches/ mm	"T" Thickness inches/ mm
2 DN50	2.375 60.3	3.25 83	2.00 51	3.25 83	3.38 86	0.59 15
2½	2.875 73.0	3.75 95	2.25 57	3.75 95	3.88 99	0.59 15
3 DN80	3.500 88.9	4.25 108	2.50 64	4.25 108	4.38 111	0.59 15
4 DN100	4.500 114.3	5.00 127	3.00 76	5.00 127	5.00 127	0.64 16
6 DN150	6.625 168.3	6.50 165	3.50 89	6.50 165	6.50 165	0.64 16
8 DN200	8.625 219.1	—	—	9.25 235	—	0.84 21
10 DN250	10.750 273.0	—	—	—	—	0.84 21
12 DN300	10.750 323.9	—	—	—	—	0.86 22



For the most up-to-date dimensional information, always refer to the current Victaulic product publication, which can be downloaded at [victaulic.com](http://victaulic.com).



# FIRELOCK™ FITTINGS

No. 001 – 90° Elbow

No. 003 – 45° Elbow

No. 002 – Straight Tee

No. 006 – Cap

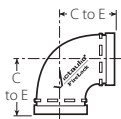

NO. 001



NO. 003

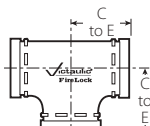

NO. 002



NO. 006

Nominal Size inches/DN	Actual Pipe Outside Diameter inches/mm	No. 001	No. 003	No. 002	No. 006
		C to E inches/mm	C to E inches/mm	C to E inches/mm	"T" Thickness inches/mm
1 ¼ DN32	1.660 42.4	—	—	—	0.82 21
1 ½ DN40	1.900 48.3	—	—	—	0.82 21
2 DN50	2.375 60.3	2.75 70	2.00 51	2.75 70	0.88 22
2 ½	2.875 73.0	3.00 76	2.25 57	3.00 76	0.88 22
DN65	3.000 76.1	3.00 76	2.25 57	3.00 76	—
3 DN80	3.500 88.9	3.38 86	2.50 64	3.38 86	0.88 22
	4.250 108.0	4.00 102	3.00 76	4.00 102	—
4 DN100	4.500 114.3	4.00 102	3.00 76	4.00 102	1.00 25
DN125	5.500 139.7	4.88 124	3.25 83	4.88 124	—
5	5.563 141.3	4.88 124	3.25 82.6	4.88 124	1.00 25
	6.250 159.0	5.50 140	3.50 89	5.50 140	—
6 DN150	6.625 168.3	5.50 140	3.50 89	5.50 140	1.00 25
	6.500 165.1	5.43 140	3.50 89	5.50 140	—
8 DN200	8.625 219.1	6.81 173	4.25 108	6.94 176	1.13 29
	8.515 216.3	6.81 173	—	6.94 176	—



For the most up-to-date dimensional information, always refer to the current Victaulic product publication, which can be downloaded at [victaulic.com](http://victaulic.com).



# FIRELOCK™ FITTINGS

## No. 10-DR – Drain Elbow

Nominal Size inches/DN	Actual Pipe Outside Diameter inches/mm	C to E inches/ mm	H inches/ mm	P inches/ mm
2½	2.875 73.0	3.75 95	2.75 70	1.68 43
3 DN80	3.500 88.9	4.25 108	2.75 70	2.10 53
4 DN100	4.500 114.3	5.00 127	2.75 70	2.60 66
6 DN150	6.625 168.3	6.50 165	2.75 70	3.65 93

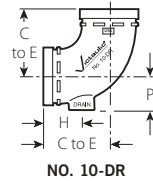

**NOTE:** The drain is drilled and tapped for a 1-inch/25-mm NPT outlet

## No. 67 Vic®-End II End-of-Run Fitting

Nominal Size inches/DN		C to GE inches/mm	C to TE inches/mm
1¼ DN32	× DN15	1.875 48	1.380 35
		1.875 48	1.380 35
		2.000 51	1.750 44
1½ DN40	× DN15	1.875 48	1.500 38
		1.875 48	1.500 38
		2.000 51	1.625 41
2 DN50	× DN15	1.875 48	1.750 44
		1.875 48	1.750 44
		2.000 51	1.750 44
2½	× DN15	1.875 48	2.000 51
		1.875 48	2.000 51
		2.000 51	2.000 51
3 DN80	× DN20	2.000 51	2.375 60
		2.000 51	2.375 60

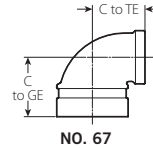

For the most up-to-date dimensional information, always refer to the current Victaulic product publication, which can be downloaded at [victaulic.com](http://victaulic.com).

# FIRELOCK™ FITTINGS

## No. 101 Installation-Ready™ 90° Elbow

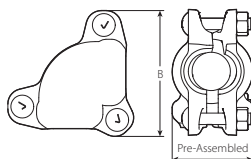

NO. 101

Nominal Size inches/DN	Actual Pipe Outside Diameter inches/mm	Take Out inches/mm	B inches/mm	Pre-Assembled inches/mm
1 ¼ DN32	1.660 42.4	1.50 38	4.75 121	3.19 81
1 ½ DN40	1.900 48.3	1.56 40	5.00 127	3.50 89
2 DN50	2.375 60.3	1.88 48	5.63 143	4.19 106
2 ½	2.875 73.0	2.13 54	6.13 156	4.63 118
DN65	3.000 76.1	2.19 56	6.19 157	4.75 121

## No. 102 Installation-Ready™ Tee

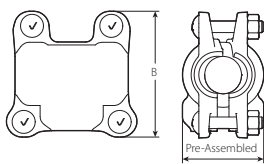

NO. 102

Nominal Size inches/DN	Actual Pipe Outside Diameter inches/mm	Take Out inches/mm	B inches/mm	Pre-Assembled inches/mm
1 ¼ DN32	1.660 42.4	1.50 38	4.75 121	3.19 81
1 ½ DN40	1.900 48.3	1.56 40	5.00 127	3.50 89
2 DN50	2.375 60.3	1.88 48	5.50 140	4.19 106
2 ½	2.875 73.0	2.13 54	6.00 152	4.63 118
DN65	3.000 76.1	2.19 56	6.19 157	4.75 121

 For the most up-to-date dimensional information, always refer to the current Victaulic product publication, which can be downloaded at [victaulic.com](http://victaulic.com).



# FIRELOCK™ FITTINGS

## No. 103 Installation-Ready™ 45° Elbow

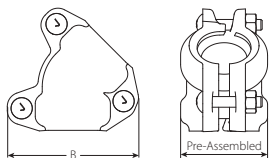

NO. 103

Nominal Size inches/DN	Actual Pipe Outside Diameter inches/mm	Take Out inches/mm	B inches/mm	Pre-Assembled inches/mm
1 ¼ DN32	1.660 42.4	0.81 21	4.69 119	3.19 81
1 ½ DN40	1.900 48.3	0.94 24	4.81 122	3.44 87
2 DN50	2.375 60.3	1.00 25	5.44 138	4.19 106
2 ½	2.875 73.0	1.13 29	5.94 151	4.63 117
DN65	3.000 76.1	1.13 29	6.13 156	4.75 121

## No. 104 Installation-Ready™ Bullhead Tee

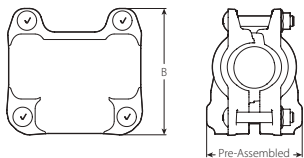

NO. 104

Nominal Size inches/DN	Actual Pipe Outside Diameter inches/mm	Take Out inches/ mm	B inches/ mm	Pre- Assem. inches/ mm
1 ½ x 1 ½ x 2 DN40 x DN40 x DN50	1.900 x 1.900 x 2.375 48.3 x 48.3 x 60.3	1.88 48	5.38 137	4.13 105
2 x 2 x 2 ½ DN50 x DN50 x 73.0 mm	2.375 x 2.375 x 2.875 60.3 x 60.3 x 73.0	2.13 54	5.88 149	4.63 117
2 ½ x 2 ½ x 3 73.0 mm x 73.0 mm x DN80	2.875 x 2.875 x 3.500 73.0 x 73.0 x 88.9	2.38 60	6.50 165	5.25 133



For the most up-to-date dimensional information, always refer to the current Victaulic product publication, which can be downloaded at [victaulic.com](http://victaulic.com).

# FIRELOCK™ FITTINGS

## No. 143 – Close Nipple (Fitting-to-Fitting Connections)

Nominal Size inches/DN	Actual Pipe Outside Diameter inches/mm	E to E inches/mm
1 ¼ DN32	1.660 42.4	2.37 60
1 ½ DN40	1.900 48.3	2.37 60
2 DN50	2.375 60.3	2.37 60
2 ½	2.875 73.0	2.37 60
DN65	3.000 76.1	2.37 60

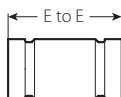

NO. 143



For the most up-to-date dimensional information, always refer to the current Victaulic product publication, which can be downloaded at [victaulic.com](http://victaulic.com).

# INNOVATIVE GROOVE SYSTEM IGS™ FITTINGS

## No. 65 OGS x IGS™ Grooved End-of-Run Fitting

Nominal Size inches/DN	Actual Pipe Outside Diameter inches/mm	C to E inches/mm
1 ¼ DN32	1.660 42.4	1.88 48
1 ½ DN40	1.900 48.3	2.00 51
2 DN50	2.375 60.3	2.25 57
2 ½ DN65	2.875 73.0	2.50 64
3 DN80	3.000 76.1	2.50 64
	3.500 88.9	2.75 70

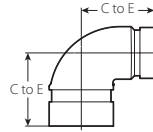

NO. 65

## No. 101 Installation-Ready™ 90° Elbow

Nominal Size inches/DN	Actual Pipe Outside Diameter inches/mm	B inches/mm	Pre- Assembled inches/mm
1 DN25	1.315 33.7	4.25 108	2.75 70

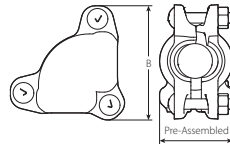

NO. 101

## No. 102 Installation-Ready™ Tee

Nominal Size inches/DN	Actual Pipe Outside Diameter inches/mm	B inches/mm	Pre- Assembled inches/mm
1 DN25	1.315 33.7	4.13 105	2.75 70

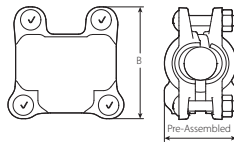

NO. 102

## No. 111 IGS™ Grooved End Elbow

Nominal Size inches/DN	Actual Pipe Outside Diameter inches/mm	C to LE inches/mm	C to SE inches/mm
1 DN25	1.315 33.7	2.70 69	1.50 38

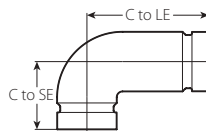

NO. 111



For the most up-to-date dimensional information, always refer to the current Victaulic product publication, which can be downloaded at [victaulic.com](http://victaulic.com).

# INNOVATIVE GROOVE SYSTEM *IGS*<sup>™</sup> FITTINGS

## No. 113 OGS x IGS<sup>™</sup> x IGS<sup>™</sup> Reduce-on-the-Run and Outlet Tee

Nominal Size inches/DN			C to E inches mm	C to E2 inches mm	C to B inches mm
1 ¼ DN32	x 1 DN25	x 1 DN25	3.05 77	2.75 70	1.90 48
1 ½ DN40	x 1 DN25	x 1 DN25	3.05 77	2.75 70	2.03 52

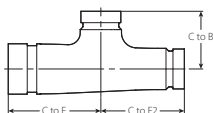

NO. 113

## No. 114 IGS<sup>™</sup> x IGS<sup>™</sup> x IGS<sup>™</sup> Grooved Tee

Nominal Size inches/DN	Actual Pipe Outside Diameter inches/mm	C to E inches/mm	C to B inches/mm
1 DN25	1.315 33.7	2.70 69	1.50 38

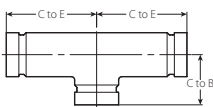

NO. 114

## No. 117 IGS<sup>™</sup> 45° Elbow

Nominal Size inches/DN	Actual Pipe Outside Diameter inches/mm	C to E inches mm
1 DN25	1.315 33.7	1.55 39

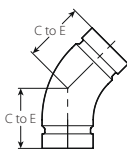

NO. 117

## No. 140 Male Threaded x Groove Adapter

Nominal Size inches/DN	Actual Pipe Outside Diameter inches/mm	E to E inches/mm
1 DN25	1.315 33.7	2.50 63.5

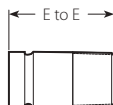

NO. 140



For the most up-to-date dimensional information, always refer to the current Victaulic product publication, which can be downloaded at [victaulic.com](http://victaulic.com).



# INNOVATIVE GROOVE SYSTEM FITTINGS

## No. 141 Male Threaded x Groove Adapter

Nominal Size inches/DN	Actual Pipe Outside Diameter inches/mm	E to E inches/mm
1 DN25	1.315 33.7	2.00 50.8

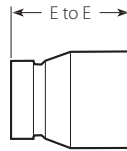

NO. 141

## No. 142 Welded Outlet

Nominal Size inches/DN	Actual Pipe Outside Diameter inches/mm	E to E inches/mm
1 ¼ - 1 ½ DN32 - DN40	1.660 - 1.900 42.4 - 48.3	1.00 25.4
1 ½ - 2 DN40 - DN50	1.900 - 2.375 48.3 - 60.3	1.00 25.4
2 - 2 ½ DN50 - 73.0	2.375 - 2.875 60.3 - 73.0	1.00 25.4
2 ½ - 3 73.0 - DN80	2.875 - 3.500 73.0 - 88.9	1.00 25.4
3 - 4 DN80 - DN100	3.500 - 4.500 88.9 - 114.3	1.00 25.4

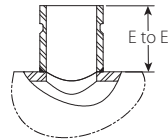

NO. 142

## No. 143 Close Nipple

Nominal Size inches/DN	Actual Pipe Outside Diameter inches/mm	E to E inches/mm
1 DN25	1.315 33.7	1.5 38
		2 51
		2.5 64
		3 76
		3.5 89
		4 102
		4.5 114
		5 127

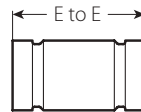

NO. 143



For the most up-to-date dimensional information, always refer to the current Victaulic product publication, which can be downloaded at [victaulic.com](http://victaulic.com).

# INNOVATIVE GROOVE SYSTEM **IGS™** FITTINGS

## No. 144 OGS x IGS™ Grooved Concentric Reducer

Nominal Size inches/DN	Grooved Outlet	Actual Pipe Outside Diameter inches/ mm	Grooved Outlet	E to E inches/mm
1 ¼ DN32	x 1 DN25	1.660 42.4	x 1.315 33.7	3.00 76
1 ½ DN40		1.900 48.3		3.00 76



NO. 144

## No. 145 Female Threaded x Groove Elbow

Nominal Size inches/DN	Grooved Outlet	Actual Pipe Outside Diameter inches/mm	Grooved Outlet	C-TE inches/ mm	C-GE inches/ mm
½ DN15	x 1 DN25	0.840 21.3	x 1.315 33.7	1.45 36.8	1.60 40.6
¾ DN20		1.050 26.9		1.45 36.8	1.60 40.6
1 DN25		1.315 33.7		1.50 38.1	1.60 40.6

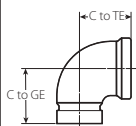

NO. 145

## No. 146 Cap

Nominal Size inches/DN	Actual Pipe Outside Diameter inches/mm	T inches/mm
1 DN25	1.315 33.7	0.55 14.0



No. 146

## No. 147 Back-To-Back Sprinkler Tee

Nominal Size inches/DN	Actual Pipe Outside Diameter inches/mm	C to TE inches/mm	C to GE inches/mm
1 DN25 x ½ DN15 x 1 DN25	1.315 33.7 x 0.840 21.3 x 1.315 33.7	1.75 44.5	1.60 40.6

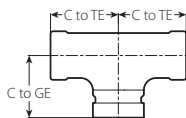

NO. 147



For the most up-to-date dimensional information, always refer to the current Victaulic product publication, which can be downloaded at [victaulic.com](http://victaulic.com).



# INNOVATIVE GROOVE SYSTEM **IGS™** FITTINGS

## No. 148 Sprinkler Reducer

Nominal Size inches/DN	Actual Pipe Outside Diameter inches/mm	Length	Threaded Outlet Size	
		E to E inches/ mm	inches/ DN	inches/ DN
1 DN25	1.315 33.7	3 76	½ DN15	¾ DN20
		3.5 89	½ DN15	¾ DN20
		4 102	½ DN15	¾ DN20
		4.5 114	½ DN15	¾ DN20
		5 127	½ DN15	¾ DN20
		5.5 140	½ DN15	¾ DN20
		6 152	½ DN15	¾ DN20
		12 305	½ DN15	¾ DN20
		18 457	½ DN15	¾ DN20
		24 610	½ DN15	¾ DN20
		30 762	½ DN15	¾ DN20



NO. 148

## WB-1 Weld Plunger Cone

E to E inches/mm	D1 inches/mm	D2 inches/mm
3.75 95.3	1.63 41.3	2.00 50.8

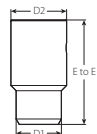

WB-1

## NAP-1 Weld Plunger Cone

E to E inches/mm	D1 inches/mm	D2 inches/mm
1.75 44.5	1.88 47.6	1.50 38.0

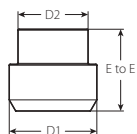

NAP-1



For the most up-to-date dimensional information, always refer to the current Victaulic product publication, which can be downloaded at [victaulic.com](http://victaulic.com).

# PLAIN-END FITTINGS

No. 10P – 90° Elbow

No. 11P – 45° Elbow

No. 20P – Tee

No. 30P – 45° Lateral

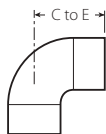

NO. 10P

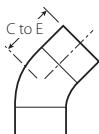

NO. 11P

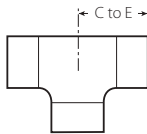

NO. 20P

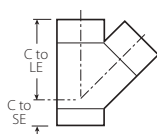

NO.30P

Nominal Size inches/DN	Actual Pipe Outside Diameter inches/ mm	No. 10P	No. 11P	No. 20P	No. 30P	
		C to E inches/ mm	C to E inches/ mm	C to E inches/ mm	C to LE inches/ mm	C to SE inches/ mm
1 DN25	1.315 33.7	2.25 57	1.75 44	2.25 57	5.00 127	2.25 57
1½ DN40	1.900 48.3	4.00 102	2.88 73	2.75 70	6.25 159	2.75 70
2 DN50	2.375 60.3	4.75 121	3.13 80	3.25 83	7.25 184	2.75 70
2½	2.875 73.0	5.50 140	3.50 89	3.75 95	7.75 197	3.00 76
3 DN80	3.500 88.9	6.25 159	3.75 95	4.25 108	8.75 222	3.25 83
3½ DN90	4.000 101.6	7.00 178	4.00 102	5.50 140	10.00 254	3.50 89
4 DN100	4.500 114.3	7.75 197	4.25 108	5.00 127	10.75 263	3.75 95
5	5.563 141.3	9.50 241	5.13 130	6.88 175	12.75 324	4.00 102
6 DN150	6.625 168.3	6.50 165	3.50 89	6.50 165	14.00 356	4.50 114
8 DN200	8.625 219.1	10.00 254	6.00 152	10.00 254	18.00 457	6.00 152
10 DN250	10.750 273.0	11.50 292	6.50 165	11.50 292	20.75 527	6.50 165
12 DN300	12.750 323.9	13.50 343	7.00 178	13.50 343	24.50 622	7.00 178



For the most up-to-date dimensional information, always refer to the current Victaulic product publication, which can be downloaded at [victaulic.com](http://victaulic.com).



# PLAIN-END FITTINGS

## No. 25P Reducing Tee

Nominal inches/DN			C to E inches/mm		
1 1/2 DN40	x	1 1/2 DN40	x	1 DN25	4.00 102
2 DN50	x	2 DN50	x	1 DN25	4.25 108
				8 DN200	4.25 108
3 DN80	x	3 DN80	x	1 DN25	5.13 130
				1 1/2 DN40	5.13 130
				2 DN50	5.13 130
				2 1/2 DN50	5.13 130
4 DN100	x	4 DN100	x	1 DN25	5.88 149
				1 1/2 DN40	5.88 149
				2 DN50	5.88 149
				2 1/2 DN50	5.88 149
				3 DN80	5.88 149
6 DN150	x	6 DN150	x	2 DN50	7.63 194
				3 DN80	7.63 194
				4 DN100	7.63 194
				4 DN100	7.63 194
8 DN200	x	8 DN200	x	2 DN50	7.63 194
				3 DN80	10.00 254
				4 DN100	10.00 254
				5 DN100	10.00 254
				6 DN150	10.00 254
				6 DN150	10.00 254
10 DN250	x	10 DN250	x	4 DN100	11.50 292
				6 DN150	11.50 292
				8 DN200	11.50 292
12 DN300	x	12 DN300	x	6 DN150	13.50 343
				8 DN200	13.50 343
				10 DN250	13.50 343

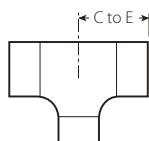

NO. 25P



For the most up-to-date dimensional information, always refer to the current Victaulic product publication, which can be downloaded at [victaulic.com](http://victaulic.com).

# PLAIN-END FITTINGS

No. 33P – 90° Wye

No. 35P – Cross

No. 61P – Bull Plug

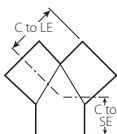

No. 33P

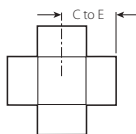

No. 35P

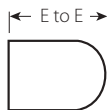

No. 61P

Nominal Size inches/DN	Actual Pipe Outside Diameter inches/mm	No. 33P		No. 35P	No. 61P
		C to LE inches/mm	C to SE inches/mm	C to E inches/mm	E to E inches/mm
1 DN25	1.315 33.7	3.25 83	2.25 57	3.25 83	3.00 76
1 ½ DN40	1.900 48.3	4.00 102	2.75 70	4.00 102	3.50 89
2 DN50	2.375 60.3	4.25 108	2.75 70	4.25 108	4.00 102
2 ½	2.875 73.0	4.75 121	3.00 76	4.75 121	5.00 127
3 DN80	3.500 88.9	5.13 130	3.25 83	5.13 130	6.00 152
3 ½ DN90	4.000 101.6	5.50 140	3.50 89	5.50 140	6.50 165
4 DN100	4.500 114.3	5.88 149	3.75 95	5.88 149	7.00 178
5	5.563 141.3	6.88 175	4.00 102	6.88 175	8.50 216
6 DN150	6.625 168.3	7.63 194	4.50 114	7.63 194	10.00 254
8 DN200	8.625 219.1	10.00 254	6.00 152	10.00 254	11.0 279
10 DN250	10.750 273.0	11.50 292	6.50 165	11.50 292	13.00 330
12 DN300	12.750 323.9	13.50 343	7.00 178	13.50 343	14.00 356



For the most up-to-date dimensional information, always refer to the current Victaulic product publication, which can be downloaded at [victaulic.com](http://victaulic.com).



# PLAIN-END FITTINGS

## No. 53P – Swaged Nipple

Nominal Size inches/DN		E to E inches/mm
1 ½ DN40	x 1 DN25	4.50 114
2 DN50	x 1 DN25	6.50 165
	1 ½ DN40	6.50 165
2 ½	x 1 DN25	7.00 178
	1 ½ DN40	7.00 178
	2 DN50	7.00 178
3 DN80	x 1 DN25	8.00 203
	1 ½ DN40	8.00 203
	2 DN50	8.00 203
3 ½ DN90	x 3 DN80	8.00 203
4 DN100	x 1 DN25	9.00 229
	1 ½ DN40	9.00 229
	2 DN50	9.00 229
	2 ½	9.00 229
	3 DN80	9.00 229
	3 ½ DN90	9.00 229
	5	x 2 DN50
	3 DN80	11.00 279
	4 DN100	11.00 279

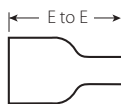

NO. 53P



For the most up-to-date dimensional information, always refer to the current Victaulic product publication, which can be downloaded at [victaulic.com](http://victaulic.com).

# PLAIN-END FITTINGS

## No. 53P – Swaged Nipple

Nominal Size inches/DN		E to E inches/mm
6 DN150	x 1 DN25	12.00 305
	1 ½ DN40	12.00 305
	2 DN50	12.00 305
	2 ½	12.00 305
	3 DN80	12.00 305
	3 ½ DN90	12.00 305
	4 DN100	12.00 305
	5	12.00 305
	8 DN200	x 3 DN80
4 DN100		13.00 330
5		13.00 330
6 DN150		13.00 330
10 DN250	x 3 DN80	15.00 381
	4 DN100	15.00 381
	6 DN150	15.00 381
	8 DN200	15.00 381
	12 DN300	x 6 DN150
8 DN200		16.00 406
10 DN250		16.00 406

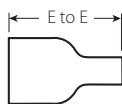

NO. 53P



For the most up-to-date dimensional information, always refer to the current Victaulic product publication, which can be downloaded at [victaulic.com](http://victaulic.com).



# PLAIN-END FITTINGS

No. 40P – Adapter Nipple

No. 42P– Adapter Nipple

No. 43P – Adapter Nipple

Nominal Size inches/DN	Actual Pipe Outside Diameter inches/mm	E to E inches/mm
1 DN25	1.315 33.7	3.00 76
1½ DN40	1.900 48.3	4.00 102
2 DN50	2.375 60.3	4.00 102
2½	2.875 73.0	4.00 102
3 DN80	3.500 88.9	4.00 102
4 DN100	4.500 114.3	6.00 152
6 DN150	6.625 168.3	6.00 152



NO. 40P

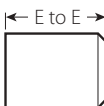

NO. 42P

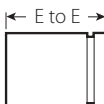

NO. 43P

No. 10P – 90° Elbow

No. 11P – 45° Elbow

Nominal Size inches/DN	Actual Pipe Outside Diameter inches/mm	No. 10P	No. 11P
		C to E inches/mm	C to E inches/mm
1 DN25	1.315 33.7	3.25 83	2.63 67
1½ DN40	1.900 48.3	4.00 102	2.88 67
2 DN50	2.375 60.3	4.75 121	3.13 80
2½	2.875 73.0	5.50 140	3.50 89
3 DN80	3.500 88.9	6.25 159	3.75 95
3½ DN90	4.000 101.6	7.00 178	4.00 102
4 DN100	4.500 114.3	7.75 197	4.25 108
5	5.563 141.3	9.50 241	5.13 130
6 DN150	6.625 168.3	11.00 279	5.75 146
8 DN200	8.625 219.1	10.00 254	6.00 152
10 DN250	10.750 273.0	11.50 292	6.50 159
12 DN300	12.750 323.9	13.50 343	7.00 178

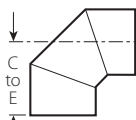

NO. 10P

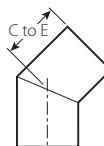

NO. 11P



For the most up-to-date dimensional information, always refer to the current Victaulic product publication, which can be downloaded at [victaulic.com](http://victaulic.com).

# PLAIN-END FITTINGS

No. 100P – 90° Long-Radius Elbow

No. 110P – 45° Long-Radius Elbow

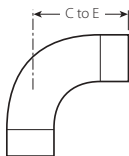

No. 100P

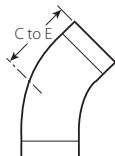

No. 110P

Nominal Size inches/DN	Actual Pipe Outside Diameter inches/mm	No. 100P	No. 110P
		C to E inches/mm	C to E inches/mm
2 DN50	2.375 60.3	4.75 121	3.13 80
2½	2.875 73.0	5.50 140	3.50 89
3 DN80	3.500 88.9	6.25 159	3.75 95
4 DN100	4.500 114.3	8.00 203	4.50 114
6 DN150	6.625 168.3	11.13 283	5.88 149
8 DN200	8.625 219.1	14.13 359	7.13 181
10 DN250	10.750 273.0	17.13 435	8.38 213
12 DN300	12.750 323.9	20.13 511	9.63 245



For the most up-to-date dimensional information, always refer to the current Victaulic product publication, which can be downloaded at [victaulic.com](http://victaulic.com).



# INSTALLATION-READY™ COUPLINGS FOR OGS GROOVED-END PIPE

## Style 107V – QuickVic™ Installation-Ready™ Rigid Coupling

Nominal Size inches/DN	Actual Pipe Outside Diameter inches/mm	Y inches/mm
2 DN50	2.375 60.3	6.13 156
2½	2.875 73.0	6.75 171
3 DN80	3.500 88.9	7.38 187
4 DN100	4.500 114.3	8.75 222
5	5.563 141.3	10.38 264
6 DN150	6.625 168.3	11.38 289
8 DN200	8.625 219.1	14.38 365
10 DN250	10.750 273.0	17.25 438
12 DN300	12.750 323.9	19.25 489

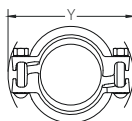

STYLE 107V

## Style 004N – FireLock™ Installation-Ready™ Flexible Coupling

Nominal Size inches/DN	Actual Pipe Outside Diameter inches/mm	Y inches/mm
2 DN50	2.375 60.3	6.38 162
2½	2.875 73.0	6.88 175
3 DN80	3.500 88.9	7.50 191
4 DN100	4.500 114.3	9.50 241
5	5.563 141.3	11.32 288
6 DN150	6.625 168.3	12.38 314
8 DN200	8.625 219.1	15.13 384

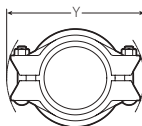

STYLE 004N



For the most up-to-date dimensional information, always refer to the current Victaulic product publication, which can be downloaded at [victaulic.com](http://victaulic.com).

# INSTALLATION-READY™ COUPLINGS FOR OGS GROOVED-END PIPE

Style 009N – FireLock EZ™ Installation-Ready™ Rigid Coupling

Style 107N/807N – QuickVic™ Installation-Ready™ Rigid Coupling

Style 109 – FireLock EZ™ Installation-Ready™ Rigid Coupling

Style 177N/877N – QuickVic™ Installation-Ready™ Flexible Coupling

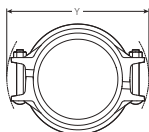

STYLE 009N

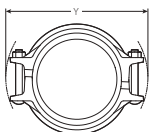

STYLE 107N/807N

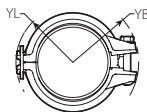

STYLE 109

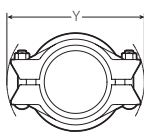

STYLE 177N/877N

Nominal Size inches/ DN	Actual Pipe Outside Diameter inches/mm	Dimensions – inches/mm				
		Style 009N	Style 107N/807N	Style 109		Style 177N/877N
		Y	Y	YL	YB	Y
1¼ DN32	1.660 42.4	5.00 127	—	1.97 50	2.49 63	—
1½ DN40	1.900 48.3	5.13 130	—	2.13 54	2.60 66	—
2 DN50	2.375 60.3	5.63 143	6.13 156	2.32 59	2.85 72	6.25 159
2½	2.875 73.0	6.13 156	6.75 171	2.63 67	3.09 78	6.88 175
DN65	3.000 76.1	6.00 152	6.88 175	2.68 68	3.22 82	6.88 175
3 DN80	3.500 88.9	6.75 171	7.38 187	2.93 74	3.53 90	7.38 187
	4.250 108.0	7.38 187	8.50 216	—	—	9.13 232
4 DN100	4.500 114.3	7.88 200	8.75 222	3.47 88	4.01 102	9.38 238
	5.250 133.0	9.00 229	10.00 254	—	—	11.00 279
DN125	5.500 139.7	9.25 235	10.25 260	—	—	11.00 279
5	5.563 141.3	9.25 235	10.25 260	—	—	11.03 280
	6.250 159.0	10.00 254	11.00 279	—	—	11.88 302
	6.500 165.1	10.25 260	11.25 286	—	—	12.13 308
6 DN150	6.625 168.3	10.38 264	11.38 289	—	—	12.38 314
	8.500 216.0	13.25 337	—	—	—	—
	8.515 216.3	—	14.25 362	—	—	—
8 DN200	8.625 219.1	13.38 340	14.37 365	—	—	15.13 384



For the most up-to-date dimensional information, always refer to the current Victaulic product publication, which can be downloaded at [victaulic.com](http://victaulic.com).



# INSTALLATION-READY™ COUPLINGS FOR OGS GROOVED-END PIPE

Style 009N – FireLock EZ™ Installation-Ready™ Rigid Coupling

Style 107N/807N – QuickVic™ Installation-Ready™ Rigid Coupling

Style 109 – FireLock EZ™ Installation-Ready™ Rigid Coupling

Style 177N/877N – QuickVic™ Installation-Ready™ Flexible Coupling

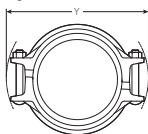

STYLE 009N

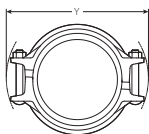

STYLE 107N/807N

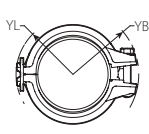

STYLE 109

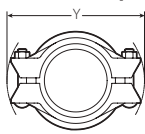

STYLE 177N/877N

Nominal Size inches/ DN	Actual Pipe Outside Diameter inches/mm	Dimensions – inches/mm				
		Style 009N	Style 107N/807N	Style 109		Style 177N/877N
		Y	Y	YL	YB	Y
	10.528 267.4	—	16.75 425	—	—	—
10 DN250	10.750 273.0	17.00 432	17.00 432	—	—	—
	12.539 318.5	—	18.63 473	—	—	—
12 DN300	12.750 323.9	19.00 483	19.00 483	—	—	—



For the most up-to-date dimensional information, always refer to the current Victaulic product publication, which can be downloaded at [victaulic.com](http://victaulic.com).



# STANDARD COUPLINGS FOR OGS GROOVED-END PIPE

Style 005H – FireLock™ Rigid Coupling

Style 07 – Zero-Flex™ Rigid Coupling

Style L07 – Rigid Coupling

Style HP-70 and HP-70ES – Rigid Couplings

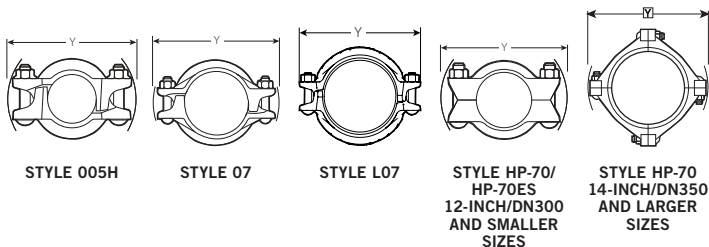

Nominal Size inches/DN	Actual Pipe Outside Diameter inches/mm	Y Dimension – inches/mm			
		Style 005H	Style 07 <sup>1</sup>	Style L07	Style HP-70 and HP-70ES <sup>2</sup>
1 DN25	1.315 33.7	—	4.22 107	—	—
1 ¼ DN32	1.660 42.4	4.50 114	4.62 117	—	—
1 ½ DN40	1.900 48.3	4.75 121	5.81 148	5.81 148	—
2 DN50	2.375 60.3	5.25 133	5.78 147	5.78 147	6.68 168
2 ½	2.875 73.0	5.75 146	6.38 162	6.38 162	7.38 187
DN65	3.000 76.1	5.75 146	6.61 168	—	—
3 DN80	3.500 88.9	6.13 156	6.81 173	6.81 173	7.75 197
	4.250 108.0	7.25 184	7.98 203	—	—
4 DN100	4.500 114.3	7.25 184	8.21 209	8.21 209	9.63 245
	5.250 133.0	9.00 229	9.60 244	—	—
DN125	5.500 139.7	9.00 229	9.82 249	—	—
5	5.563 141.3	9.00 229	9.89 251	—	—



For the most up-to-date dimensional information, always refer to the current Victaulic product publication, which can be downloaded at [victaulic.com](http://victaulic.com).



# STANDARD COUPLINGS FOR OGS GROOVED-END PIPE

Style 005H – FireLock™ Rigid Coupling

Style 07 – Zero-Flex™ Rigid Coupling

Style L07 – Rigid Coupling

Style HP-70 and HP-70ES – Rigid Couplings

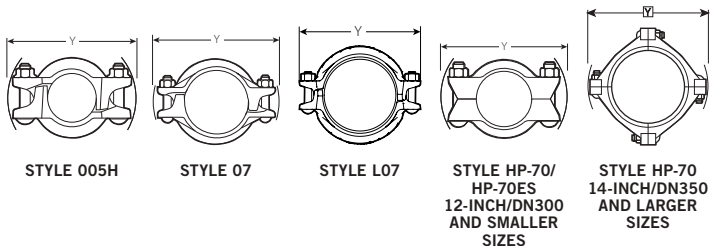

Nominal Size inches/DN	Actual Pipe Outside Diameter inches/mm	Y Dimension – inches/mm			
		Style 005H	Style 07 <sup>1</sup>	Style L07	Style HP-70 and HP-70ES <sup>2</sup>
	6.250 159.0	10.00 254	10.54 268	—	—
	6.500 165.1	10.00 254	10.84 275	—	—
6 DN150	6.625 168.3	10.00 254	10.83 275	10.83 275	12.68 321
8 DN200	8.625 219.1	13.14 334	13.74 349	13.74 349	15.00 381
10 DN250	10.750 273.0	—	16.98 431	16.98 431	17.25 438
12 DN300	12.750 323.9	—	18.88 480	18.88 480	19.13 486
14 DN350	14.000 355.6	—	—	—	22.00 559
16 DN400	16.000 406.4	—	—	—	24.13 613

<sup>1</sup> For 14-inch/DN350 and larger sizes, Victaulic offers the Advanced Groove System (AGS). Refer to publication 20.02 for information on the Style W07 AGS Rigid Coupling.

<sup>2</sup> Style HP-70ES Couplings are not available in 14-inch/DN350 and larger sizes.



For the most up-to-date dimensional information, always refer to the current Victaulic product publication, which can be downloaded at [victaulic.com](http://victaulic.com).

# STANDARD COUPLINGS FOR OGS GROOVED-END PIPE

## Style 72 – Outlet Coupling

Run × Reducing Outlet Nominal Size inches/DN		V inches/mm	Y inches/mm
1 ½ DN40	×	½ DN15	2.63 67
		¾ DN20	2.63 67
		1 DN25	2.63 67
			4.50 114
2 DN50	×	½ DN15	3.03 77
		¾ DN20	3.03 77
		1 DN25	3.03 77
			5.00 127
2 ½	×	½ DN15	3.13 79
		¾ DN20	3.13 79
		1 DN25	3.13 79
		1 ¼ DN32	3.75 95
		1 ½ DN40	3.75 95
			6.00 152
3 DN80	×	¾ DN20	3.31 84
		1 DN25	4.25 108
		1 ¼ DN32	4.25 108
		1 ½ DN40	4.25 108
			7.00 178
4 DN100	×	¾ DN20	3.88 98
		1 DN25	3.88 98
		1 ½ DN40	4.63 117
		2 DN50	4.63* 117
			8.38 213
6 DN150	×	1 DN25	6.00 152
		1 ½ DN40	6.00 152
		2 DN50	6.00 152
			12.00 305
		DN65	5.75 146

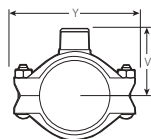

**STYLE 72  
(FEMALE THREADED  
OUTLET)**

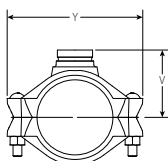

**STYLE 72  
(GROOVED OUTLET)**

\* The "V" dimension for the grooved outlet in the 4x2-inch/DN100xDN50 size is 4.50 inches/114 mm.



For the most up-to-date dimensional information, always refer to the current Victaulic product publication, which can be downloaded at [victaulic.com](http://victaulic.com).



# STANDARD COUPLINGS FOR OGS GROOVED-END PIPE

Style 75 – Coupling

Style 77 – Standard Flexible Coupling

Style L77 Flexible Coupling

Style 77A – Flexible Aluminum Coupling

Styles 77S and 77DX – Flexible Stainless Steel Couplings

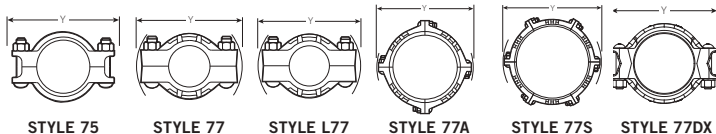

STYLE 75

STYLE 77

STYLE L77

STYLE 77A

STYLE 77S

STYLE 77DX

Nominal Size inches/DN	Actual Pipe Outside Diameter inches/mm	Y Dimension – inches/mm					
		Style 75	Style 77 <sup>1</sup>	Style L77	Style 77A	Style 77S	Style 77DX
¾ DN20	1.050 26.9	—	4.00 102	—	—	4.00 102	3.89 99
1 DN25	1.315 33.7	4.27 108	4.12 105	—	4.25 108	4.50 114	4.50 114
1¼ DN32	1.660 42.4	4.61 117	5.00 127	—	5.04 128	4.88 124	4.79 122
1½ DN40	1.900 48.3	4.82 122	5.38 137	5.38 137	5.36 136	4.88 124	4.80 122
2 DN50	2.375 60.3	5.22 133	5.88 149	5.88 149	5.90 150	5.38 136	5.33 135
	2.664 67.8	—	5.73 146	—	—	—	—
2½	2.875 73.0	5.68 144	6.50 165	6.50 165	6.51 165	5.88 149	5.79 147
DN65	3.000 76.1	5.90 150	6.63 168	—	—	—	—
3 DN80	3.500 88.9	7.00 178	7.13 181	7.13 181	7.79 182	7.00 178	6.99 178
3½ DN90	4.000 101.6	7.50 191	8.25 210	—	—	—	—
	4.250 108.0	7.79 198	8.63 219	—	—	—	—
4 DN100	4.500 114.3	8.03 204	8.88 226	8.88 226	8.91 226	8.25 210	9.00 229
4½	5.000 127.0	9.43 240	—	—	—	—	—
	5.250 133.0	9.37 238	10.38 264	—	—	—	—
DN125	5.500 139.7	9.59 244	10.65 270	—	—	—	—
5	5.563 141.3	10.07 256	—	—	10.60 269	—	—
	6.000 152.4	10.48 266	—	—	—	—	—
	6.250 159.0	10.49 266	11.50 292	—	—	—	—



For the most up-to-date dimensional information, always refer to the current Victaulic product publication, which can be downloaded at [victaulic.com](http://victaulic.com).



# STANDARD COUPLINGS FOR OGS GROOVED-END PIPE

Style 75 – Coupling

Style 77 – Standard Flexible Coupling

Style L77 Flexible Coupling

Style 77A – Flexible Aluminum Coupling

Styles 77S and 77DX – Flexible Stainless Steel Couplings

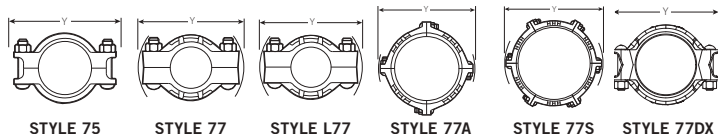

Nominal Size inches/DN	Actual Pipe Outside Diameter inches/mm	Y Dimension – inches/mm					
		Style 75	Style 77 <sup>1</sup>	Style L77	Style 77A	Style 77S	Style 77DX
	6.500 165.1	10.66 271	11.63 295		—	—	—
6 DN150	6.625 168.3	11.07 281	11.88 302	11.88 302	11.90 302	11.13 283	11.06 281
	8.515 216.3	13.75 350	—	—	—	—	—
8 DN200	8.625 219.1	13.97 355	14.75 375	14.75 375	14.86 377	14.75 375	—
10 DN250	10.750 273.0	—	17.13 435	17.13 435	—	17.38 441	—
12 DN300	12.750 323.9	—	19.25 489	19.25 489	19.28 489	19.25 489	—
14 DN350	14.000 355.6	—	20.25 514	—	—	20.50 521	—
	14.843 377.0	—	20.96 531	—	—	—	—
16 DN400	16.000 406.4	—	22.25 565	—	—	22.63 575	—
	16.772 426.0	—	22.92 581	—	—	—	—
18 DN450	18.000 457.2	—	25.00 635	—	—	24.63 626	—
	18.898 480.0	—	25.86 655	—	—	—	—
20 DN500	20.000 508.0	—	27.00 686	—	—	—	—
	20.866 530.0	—	27.80 704	—	—	—	—
22 DN550	22.000 558.8	—	29.13 740	—	—	—	—
	22.835 580.0	—	30.01 762	—	—	—	—
24 DN600	24.000 609.6	—	31.00 787	—	—	—	—
	24.803 630.0	—	32.16 817	—	—	—	—

<sup>1</sup> For 14-inch/DN350 and larger sizes, Victaulic offers the Advanced Groove System (AGS). Refer to publication 20.03 for information on the Style W77 AGS Flexible Coupling.



For the most up-to-date dimensional information, always refer to the current Victaulic product publication, which can be downloaded at [victaulic.com](http://victaulic.com).



# STANDARD COUPLINGS FOR OGS GROOVED-END PIPE

## Style 171 – Composite Flexible Coupling

Nominal Size inches/DN	Actual Pipe Outside Diameter inches/mm	Y inches/mm
1 ½ DN40	1.900 48.3	5.24 133
2 DN50	2.375 60.3	6.09 155
2 ½	2.875 73.0	6.50 165
3 DN80	3.500 88.9	7.58 193
4 DN100	4.500 114.3	8.78 223

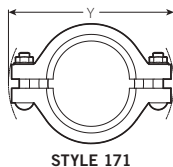

STYLE 171

## Style 78 – Snap-Joint™ Coupling

## Style 78A – Aluminum Snap-Joint™ Coupling

Nominal Size inches/DN	Actual Pipe Outside Diameter inches/mm	Y Dimension – inches/mm	
		Style 78	Style 78A
1 DN25	1.315 33.7	3.25 83	—
1 ¼ DN32	1.660 42.4	3.75 95	—
1 ½ DN40	1.900 48.3	4.50 114	—
2 DN50	2.375 60.3	4.75 121	4.88 124
2 ½	2.875 73.0	5.88 149	—
3 DN80	3.500 88.9	6.25 159	—
4 DN100	4.500 114.3	7.75 197	—
5	5.563 141.3	9.50 241	—
6 DN150	6.625 168.3	10.63 270	—
8 DN200	8.625 219.1	13.00 330	—
10 DN250	10.750 273.0	—	15.60 396

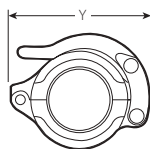

STYLE 78 AND 78A

**NOTE:** Refer to the installation instructions in this manual for locking handle clearance dimensions.



For the most up-to-date dimensional information, always refer to the current Victaulic product publication, which can be downloaded at [victaulic.com](http://victaulic.com).



# STANDARD COUPLINGS FOR OGS GROOVED-END PIPE

Style 89/889 – Rigid Couplings for Stainless Steel Pipe  
 Styles 475 and 475DX – Flexible Stainless Steel Couplings  
 Styles 489 and 489DX - Rigid Stainless Steel Couplings

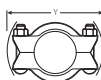

STYLE  
89/889

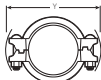

STYLE  
475/475DX



STYLE 489  
1 ½ – 4-INCH/  
DN40 – DN100  
SIZES



STYLE 489  
6 – 12-INCH/  
DN150 – DN300  
SIZES

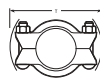

STYLE  
489DX

Nominal Size inches/DN	Actual Pipe Outside Diameter inches/mm	Y Dimension – inches/mm				
		Style 89/889	Style 475	Style 475DX	Style 489	Style 489DX
1 DN25	1.315 33.7	—	3.98 101	3.98 101	—	—
1 ¼ DN32	1.660 42.4	—	4.45 113	4.45 113	—	—
1 ½ DN40	1.900 48.3	—	4.52 115	4.52 115	4.42 118	—
2 DN50	2.375 60.3	6.68 168	5.03 128	5.03 128	5.19 132	6.18 157
2 ½	2.875 73.0	7.13 181	5.59 142	5.59 142	5.62 143	7.22 183
DN65	3.000 76.1	7.25 184	5.73 146	5.73 146	5.72 145	7.42 189
3 DN80	3.500 88.9	7.75 197	6.67 169	6.67 169	6.78 172	7.84 199
4 DN100	4.500 114.3	9.63 245	7.96 202	7.96 202	7.90 201	9.68 246
DN125	5.500 139.7	10.63 270	8.97 228	—	11.13 283	10.94 278
5	5.563 141.3	10.63 270	—	—	10.63 270	—
	6.500 165.1	12.38 314	10.53 268	—	12.68 321	12.70 323
6 DN150	6.625 168.3	12.68 321	—	—	12.68 321	12.70 323
	8.515 216.3	15.25 387	—	—	15.00 381	—
8 DN200	8.625 219.1	15.25 387	—	—	15.00 381	15.04 382
	10.528 267.4	17.00 432	—	—	17.25 438	—
10 DN250	10.750 273.0	17.25 438	—	—	17.25 438	17.29 439
	12.539 318.5	19.63 499	—	—	19.13 486	—
12 DN300	12.750 323.9	19.63 499	—	—	19.13 486	19.13 486



For the most up-to-date dimensional information, always refer to the current Victaulic product publication, which can be downloaded at [victaulic.com](http://victaulic.com).



# STANDARD COUPLINGS FOR OGS GROOVED-END PIPE

## Style 750/875 – Reducing Coupling

Nominal Size inches/DN		Y Dimension inches/mm
2 DN50	× 1 DN25	5.28 134
	1½ DN40	5.28 134
2½	× 2 DN50	5.93 151
DN65	× 2 DN50	6.63 168
3 DN80	× 2 DN50	7.13 181
	2½	7.13 181
	DN65	7.13 181
4 DN100	× 2 DN50	8.90 226
	2½	8.90 226
	3 DN80	8.90 226
	DN65	8.90 226
5	× 4 DN100	10.70 272
6 DN150	× 4 DN100	11.90 302
	5	11.90 302
165.1 mm	× 4 DN100	11.90 302
8 DN200	× 6 DN150	14.88 378
	165.1 mm	14.88 378
10 DN250	× 8 DN200	17.26 438

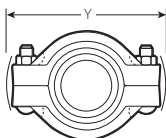

STYLE 750/875



For the most up-to-date dimensional information, always refer to the current Victaulic product publication, which can be downloaded at [victaulic.com](http://victaulic.com).

# COUPLINGS FOR IGS™ GROOVED-END PIPE

## Style 108 Installation-Ready™ Rigid Coupling

Nominal Size inches/DN	Actual Pipe Outside Diameter inches/mm	Dimensions (Pre-Assembled)		
		YL inches/ mm	YB inches/ mm	Z inches/ mm
1 DN25	1.315 33.7	1.66 42.2	2.17 55.2	2.58 65.5

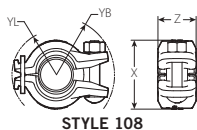

## No. 115 FireLock EZ™ Installation-Ready™ Reducing Coupling (OGS x IGS™)

Nominal Size inches/DN	Actual Pipe Outside Diameter inches/mm	Dimensions (Pre-Assembled)
		Y inches/mm
1 ¼ DN32	1.660 42.4	4.75 121
1 ½ DN40	1.900 48.3	4.88 124

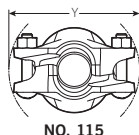

For the most up-to-date dimensional information, always refer to the current Victaulic product publication, which can be downloaded at [victaulic.com](http://victaulic.com).



# COUPLINGS FOR PLAIN-END PIPE

## Style 99 – Roust-A-Bout Coupling

Nominal Size inches/DN	Actual Pipe Outside Diameter inches/mm	Y Dimension inches/mm
1 DN25	1.315 33.7	4.25 108
1 ½ DN40	1.900 48.3	5.50 140
2 DN50	2.375 60.3	6.75 171
2 ½	2.875 73.0	7.13 181
DN65	3.000 76.1	6.25 159
3 DN80	3.500 88.9	8.50 216
3 ½ DN90	4.000 101.6	9.25 235
4 DN100	4.500 114.3	10.00 254
DN125	5.500 139.7	10.75 260
5	5.563 141.3	11.38 289
6 DN150	6.625 168.3	13.38 340
	6.500 165.1	13.25 337
8 DN200	8.625 219.1	14.38 365
10 DN250	10.750 273.0	16.38 416
12 DN300	12.750 323.9	19.63 499
14 DN350	14.000 355.6	20.75 527
16 DN400	16.000 406.4	22.63 575
18 DN450	18.000 457.2	23.50 597

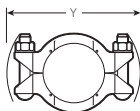

**STYLE 99**  
1 – 10-INCH/  
DN25 – DN150

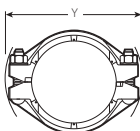

**STYLE 99**  
8 – 12-INCH/  
DN200 – DN300

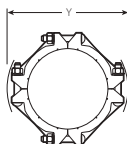

**STYLE 99**  
14 – 18-INCH/  
DN350 – DN450



For the most up-to-date dimensional information, always refer to the current Victaulic product publication, which can be downloaded at [victaulic.com](http://victaulic.com).

# VIC-FLANGE ADAPTERS FOR OGS GROOVED-END PIPE

Style 441 – Stainless Steel Vic-Flange Adapter

Style 741 – Vic-Flange Adapter

Style 743 – Vic-Flange Adapter

Style 744 – FireLock™ Flange Adapter



STYLE 441



STYLE 741  
2 – 12-INCH/  
DN50 – DN300



STYLE 741  
14 – 24-INCH/  
DN350 – DN600



STYLE 743



STYLE 744

Nominal Size inches/DN	Actual Pipe Outside Diameter inches/mm	W Dimension – inches/mm			
		Style 441	Style 741	Style 743	Style 744
2 DN50	2.375 60.3	6.84 174	6.75 172	7.75 197	6.75 172
2½	2.875 73.0	7.72 196	7.88 200	8.63 219	7.88 200
3 DN80	3.500 88.9	8.22 209	8.50 216	9.50 241	8.44 214
4 DN100	4.500 114.3	9.72 247	10.00 254	11.38 289	9.94 252
5	5.563 141.3	—	11.00 279	12.38 314	11.00 279
6 DN150	6.625 168.3	11.78 299	12.00 305	13.88 352	12.00 305
8 DN200	8.625 219.1	—	14.75 375	16.75 425	14.63 372
10 DN250	10.750 273.0	—	17.25 438	19.25 489	—
12 DN300	12.750 323.9	—	20.25 514	22.25 565	—
14 DN350	14.000 355.6	—	24.50 622	—	—
16 DN400	16.000 406.4	—	27.13 689	—	—
18 DN450	18.000 457.2	—	29.00 737	—	—
20 DN500	20.000 508.0	—	31.50 800	—	—
24 DN600	24.000 609.6	—	36.00 914	—	—



For the most up-to-date dimensional information, always refer to the current Victaulic product publication, which can be downloaded at [victaulic.com](http://victaulic.com).



# STANDARD VIC-FLANGE ADAPTERS FOR GROOVED-END PIPE

Style 741 – Vic-Flange Adapter (PN10 and PN16 Flanges)

Style 741 – Vic-Flange Adapter (Australian Standard Table “E”)

Style 741 – Vic-Flange Adapter (Chinese Standard Table “E”)



STYLE 741

Nominal Size DN/inches	Actual Pipe Outside Diameter mm/inches	W Dimension – mm/inches		
		Style 741 PN10 and PN16	Style 741 Australian Standard Table “E”	Style 741 Chinese Standard Table “E”
DN50 2	60.3 2.375	178 7.00	165 6.50	172 6.75
DN65	76.1 3.000	210 8.25	—	210 8.25
DN80 3	88.9 3.500	219 8.63	200 7.88	213 8.38
	108.0 4.250	—	—	248 9.75
DN100 4	114.3 4.500	251 9.88	251 9.88	251 9.88
	133.0 5.250	—	—	276 10.88
DN125	139.7 5.500	276 10.88	—	276 10.88
	159.0 6.250	314 12.38	—	314 12.38
	165.1 6.500	305 12.00	—	305 12.00
DN150 6	168.3 6.625	302 11.88	286 11.25	—
DN200 8	219.1 8.625	368 <sup>1</sup> 14.50	368 14.50	368 14.50
DN250 10	273.0 10.750	438 <sup>2</sup> 17.25	—	—
DN300 12	323.9 12.750	479 <sup>3</sup> 18.88	—	—

<sup>1</sup> PN16 dimensions (mm/inches): W = 360/14.17

<sup>2</sup> PN16 dimensions (mm/inches): W = 438/17.24

<sup>3</sup> PN16 dimensions (mm/inches): W = 478/18.82



For the most up-to-date dimensional information, always refer to the current Victaulic product publication, which can be downloaded at [victaulic.com](http://victaulic.com).

# HOLE-CUT PRODUCTS

## Style 912 – FireLock™ Low-Profile Sprinkler-Tee (Europe Only)

Nominal Size inches/DN	Y Dimension inches/mm		
Run x Branch FPT			
1 DN25	x	½ DN15	3.72 95
1 ¼ DN32	x	½ DN15	4.12 105
1 ½ DN40	x	½ DN15	4.32 110

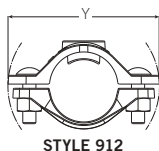

STYLE 912

## Style 922 – FireLock™ Outlet-T

Nominal Size inches/DN		Dimensions – inches/mm					
Run x Branch		V	Y				
1 ¼ DN32	x	½ DN15	1.83 47	3.87 98			
		¾ DN20	1.83 47	3.87 98			
	1 DN25	x	1 DN25	2.18 55	3.87 98		
			1 IGS™ DN25 IGS™	1.98 50	4.13 105		
			1 ½ DN40	x	½ DN15	1.95 50	4.08 104
			¾ DN20		1.95 50	4.08 104	
2 DN50	x	1 DN25	2.30 58	4.08 104			
		1 IGS™ DN25 IGS™	2.11 54	4.25 108			
	2 ½	x	½ DN15	2.19 56	4.60 117		
			¾ DN20	2.19 56	4.60 117		
		1 DN25	x	1 DN25	2.54 65	4.60 117	
				1 IGS™ DN25 IGS™	2.34 59	4.75 121	
DN65	x	½ DN15	2.44 62	5.40 137			
		¾ DN20	2.44 62	5.40 137			
	1 DN25	x	1 DN25	2.79 71	5.40 137		
			1 IGS™ DN25 IGS™	2.67 68	5.50 140		
	1 ½ DN40	x	½ DN15	2.44 62	5.50 140		
			¾ DN20	2.44 62	5.50 140		
1 DN25	x	1 DN25	2.79 71	5.50 140			
		1 IGS™ DN25 IGS™	2.75 70	5.52 140			

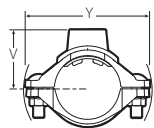

STYLE 922 WITH  
THREADED OUTLET

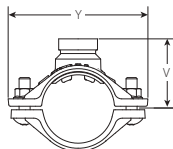

STYLE 922 WITH  
IGS™ GROOVED OUTLET



For the most up-to-date dimensional information, always refer to the current Victaulic product publication, which can be downloaded at [victaulic.com](http://victaulic.com).



# HOLE-CUT PRODUCTS

## Style 923 – Strapless Outlet (NPT and BSPT Models)

Nominal Size inches/DN	Dimensions inches/mm		
	Run x Branch	X	Y
4 – 8 DN100 – DN200	x ½ DN15	3.00 76	3.09 78
	¾ DN20	3.00 76	3.09 78
10 and Larger DN250 and Larger	x ½ DN15	3.00 76	3.00 76
	¾ DN20	3.00 76	3.00 76

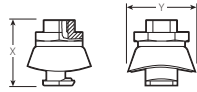

STYLE 923 (NPT/BSPT)  
4 – 8-INCH/DN100 – DN200  
SIZES

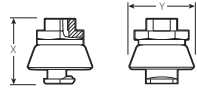

STYLE 923 (NPT/BSPT)  
10-INCH/DN250  
AND LARGER SIZES

## Style 923 – Strapless Outlet (BSPP Models)

Nominal Size inches/DN	Dimensions inches/mm			
	Run x Branch	X <sub>1</sub>	X <sub>2</sub>	Y
4 – 8 DN100 – DN200	x ½ DN15	4.50 114	3.00 76	3.09 78
	¾ DN20	4.50 114	3.00 76	3.09 78
10 and Larger DN250 and Larger	x ½ DN15	4.50 114	3.00 76	3.00 76
	¾ DN20	4.50 114	3.00 76	3.00 76

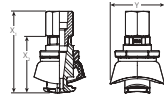

STYLE 923 (BSPP)  
4 – 8-INCH/DN100 – DN200  
SIZES

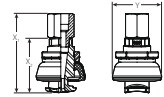

STYLE 923 (BSPP)  
10-INCH/DN250  
AND LARGER SIZES

## Style 924 – Strapless Thermometer Outlet

Nominal Size inches/DN	Dimensions inches/mm		
	Run	X	Y
4 – 8 DN100 – DN200 for 6-inch/152-mm Nominal Stem Length		7.09 180	3.09 78
10 and Larger DN250 and Larger for 6-inch/152-mm Nominal Stem Length		7.09 180	3.09 78

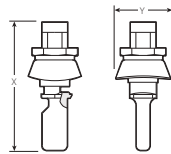

STYLE 924



For the most up-to-date dimensional information, always refer to the current Victaulic product publication, which can be downloaded at [victaulic.com](http://victaulic.com).

# HOLE-CUT PRODUCTS

## Styles 920 and 920N – Mechanical-T Outlets



Style 920 and 920N with Grooved Outlet

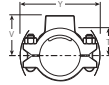

Style 920 and 920N with Female Threaded Outlet

Nominal Size inches/DN			Style	Dimensions inches/mm			
Run	x	Branch		T	Threaded V	Grooved V	Y
2 DN50	x	1/2 DN15	920N	2.00 51	2.53 64	—	5.35 136
		3/4 DN20	920N	1.97 50	2.53 64	—	5.35 136
		1 DN25	920N	1.85 47	2.53 64	—	5.35 136
		1 1/4 DN32	920N	2.05 52	2.75 70	3.00 76	5.35 136
		1 1/2 DN40	920N	2.03 52	2.75 70	3.12 79	5.35 136
		2 1/2 DN50	920N	2.21 56	2.74 70	—	5.64 143
2 1/2	x	3/4 DN20	920N	2.18 55	2.74 70	—	5.64 143
		1 DN25	920N	2.06 52	2.74 70	—	5.64 143
		1 1/4 DN32	920N	2.30 58	3.00 76	3.25 83	6.29 160
		1 1/2 DN40	920N	2.28 58	3.00 76	3.25 83	6.26 159
		1 1/2 DN40	920N	2.22 56	2.75 70	—	6.46 164
		3/4 DN20	920N	2.19 56	2.75 70	—	6.46 164
76.1 mm	x	1 DN25	920N	2.07 53	2.75 70	—	6.46 164
		1 1/4 DN32	920N	2.30 58	3.00 76	3.31 84	6.29 160
		1 1/2 DN40	920N	2.28 58	3.00 76	3.31 84	6.29 160
		1 1/2 DN40	920N	2.22 56	2.75 70	—	6.46 164
		3/4 DN20	920N	2.19 56	2.75 70	—	6.46 164
		1 DN25	920N	2.07 53	2.75 70	—	6.46 164
3 DN80	x	1/2 DN15	920N	2.52 64	3.05 78	—	6.15 156
		3/4 DN20	920N	2.49 63	3.05 78	—	6.15 156
		1 DN25	920N	2.38 61	3.06 78	—	6.15 156
		1 1/4 DN32	920N	2.55 65	3.25 83	3.56 90	6.15 156
		1 1/2 DN40	920N	2.78 71	3.50 89	3.56 90	6.15 156
		2 DN50	920N	2.75 70	3.50 89	3.56 90	6.75 172
		1 1/2 DN32	920N	2.55 65	3.25 83	3.56 90	6.15 156
		1 1/4 DN32	920N	2.55 65	3.25 83	3.56 90	6.15 156
		1 1/2 DN40	920N	2.78 71	3.50 89	3.56 90	6.15 156



For the most up-to-date dimensional information, always refer to the current Victaulic product publication, which can be downloaded at [victaulic.com](http://victaulic.com).



# HOLE-CUT PRODUCTS



Style 920 and 920N  
with Grooved Outlet

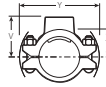

Style 920 and 920N with  
Female Threaded Outlet

Nominal Size inches/DN			Style	Dimensions inches/mm			
Run	x	Branch		T	Threaded V	Grooved V	Y
3½ DN90	x	2 DN50	920N	3.00 76	—	3.75 95	6.72 171
4 DN100	x	½ DN15	920N	3.03 77	3.56 90	—	7.01 178
		¾ DN20	920N	3.00 76	3.56 90	—	7.01 178
		1 DN25	920N	2.88 73	3.56 90	—	7.01 178
		1 <i>IGS</i> DN25 <i>IGS</i>	920N	—	—	3.62 92	7.35 187
		1¼ DN32	920N	3.08 78	3.78 96	4.00 102	7.01 178
		1½ DN40	920N	3.28 83	4.00 102	4.00 102	7.01 178
		2 DN50	920N	3.25 83	4.00 102	4.00 102	7.01 178
		2½	920	2.88 73	4.00 102	4.00 102	7.34 186
		76.1 mm	920	2.88 73	—	4.00 102	7.34 186
		3 DN80	920	3.31 84	4.50 114	4.12 105	7.73 196
		108.0 mm	x	1¼ DN32	920N	3.08 78	3.78 96
1½ DN40	920N			3.28 88	4.00 102	—	7.64 194
2 DN50	920N			3.25 83	4.00 102	—	7.64 194
76.1 mm	920			2.88 73	4.00 102	4.00 102	7.64 194
3 DN80	920			3.31 84	4.50 114	4.50 114	7.63 194
5	x	1½ DN40	920	4.03 102	4.75 121	4.75 121	9.70 246
		2 DN50	920	4.00 102	4.75 121	4.75 121	9.70 246
		2½	920	3.63 92	4.75 121	4.75 121	9.70 246
		76.1 mm	920	3.75 95	—	4.75 121	9.70 246
		3 DN80	920	3.81 97	5.00 127	4.63 118	9.70 246
		133.0 mm	x	2 DN50	920N	3.75 95	4.50 114
3 DN80	920			3.81 97	5.00 127	—	9.46 240



For the most up-to-date dimensional information, always refer to the current Victaulic product publication, which can be downloaded at [victaulic.com](http://victaulic.com).



# HOLE-CUT PRODUCTS



Style 920 and 920N  
with Grooved Outlet

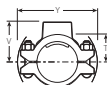

Style 920 and 920N with  
Female Threaded Outlet

Nominal Size inches/DN			Style	Dimensions inches/mm			
Run	x	Branch		T	Threaded V	Grooved V	Y
139.7 mm	x	1 1/2 DN40	920N	3.78 96	4.50 114	—	8.23 209
		2 DN50	920N	3.75 95	4.50 114	—	8.23 209
6 DN150	x	1 1/4 DN32	920N	4.43 113	5.13 130	5.13 130	9.15 232
		1 1/2 DN40	920N	4.40 112	5.13 130	5.13 130	9.15 232
		2 DN50	920N	4.38 111	5.13 130	5.13 130	9.15 232
		2 1/2	920	4.01 110	5.13 130	5.12 130	10.51 267
		76.1 mm	920	4.15 105	—	5.21 132	10.51 267
		3 DN80	920	4.31 110	5.50 140	5.13 130	10.51 267
		4 DN100	920	3.81 97	5.75 146	5.38 137	10.51 267
		159.0 mm	x	1 1/2 DN40	920N	4.41 112	5.13 130
76.1 mm	x	2 DN50	920N	4.38 111	5.13 130	—	9.40 239
		76.1 mm	920	4.38 111	5.50 140	5.13 130	9.40 239
		3 DN80	920	4.31 110	5.50 140	5.13 130	9.40 239
		108.0 mm	920	4.45 113	—	5.38 137	9.40 239
		4 DN100	920	3.81 97	5.75 146	—	9.40 239
		165.1 mm	x	1 DN25	920N	3.88 99	4.56 116
76.1 mm	x	1 1/4 DN32	920N	4.43 113	5.13 130	—	9.34 237
		1 1/2 DN40	920N	4.41 112	5.13 130	5.13 130	9.34 237
		2 DN50	920N	4.38 111	5.13 130	5.13 130	9.34 237
		76.1 mm	920	4.01 102	5.13 130	5.21 132	10.51 267
		3 DN80	920	4.31 110	5.50 140	5.13 130	10.51 267
		4 DN100	920	3.81 97	5.75 146	5.38 137	10.51 267



For the most up-to-date dimensional information, always refer to the current Victaulic product publication, which can be downloaded at [victaulic.com](http://victaulic.com).



# HOLE-CUT PRODUCTS



Style 920 and 920N  
with Grooved Outlet

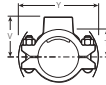

Style 920 and 920N with  
Female Threaded Outlet

Nominal Size inches/DN			Style	Dimensions inches/mm			
Run	x	Branch		T	Threaded V	Grooved V	Y
8 DN200	x	2 DN50	920	5.44 138	6.19 157	6.25 159	12.42 316
		2½	920	5.07 129	6.19 157	6.19 157	12.42 316
	76.1 mm	920	5.25 133	—	6.25 159	12.42 316	
	3 DN80	920	5.31 135	6.50 165	6.50 165	12.42 316	
	4 DN100	920	4.81 122	6.75 172	6.38 162	12.42 316	



For the most up-to-date dimensional information, always refer to the current Victaulic product publication, which can be downloaded at [victaulic.com](http://victaulic.com).

# HOLE-CUT PRODUCTS

## Style L920N Mechanical-T Outlet (Female – NPT)

Nominal Size inches/DN			Dimensions inches/mm		
Run	x	Branch	T	V	Y
2 DN50	x	1/2 DN15	1.97 50	2.53 64	5.35 136
		3/4 DN20	1.97 50	2.53 64	5.35 136
		1 1/2 DN40	1.85 47	2.53 64	5.35 136
		3/4 DN20	2.49 63	3.05 78	6.15 156
3 DN80	x	1 1/2 DN40	2.38 61	3.06 78	6.15 156
		1/2 DN15	3.03 77	3.56 90	7.01 178
4 DN100	x	3/4 DN20	3.00 76	3.56 90	7.01 178
		1 1/2 DN40	2.88 73	3.56 90	7.01 178
		3/4 DN20	3.73 95	4.64 118	9.15 232
		1 1/2 DN40	4.40 112	5.13 130	9.15 232
6 DN150	x	1 DN50	4.38 111	5.13 130	9.15 232
		3/4 DN20	5.01 127	5.69 145	12.42 316
		1 DN25	5.44 138	6.19 157	12.42 316
10 DN250	x	3/4 DN20	6.01 153	6.69 170	14.67 373
		1 1/2 DN40	6.01 153	6.69 170	14.67 373
12 DN300	x	3/4 DN20	7.13 181	7.81 198	17.38 442
		1 1/2 DN40	7.13 181	7.81 198	17.38 442
14 DN350	x	3/4 DN20	7.75 197	8.43 214	17.95 456
		1 1/2 DN40	7.75 197	8.43 214	17.95 456
		3/4 DN20	8.75 222	9.43 240	19.74 501
16 DN400	x	DN20	222	240	501

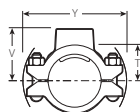

STYLE L920N



For the most up-to-date dimensional information, always refer to the current Victaulic product publication, which can be downloaded at [victaulic.com](http://victaulic.com).



**U.S./World Headquarters**

4901 Kesslersville Road  
Easton, PA 18040 USA

◀ [victauliclocations.com](http://victauliclocations.com)

**EMEA**

Prijkelstraat 36  
9810 Nazareth, Belgium

**Asia Pacific**

Unit 808, Building B  
Hongwell International Plaza  
No.1602 West Zhongshan Road  
Shanghai, China 200235

**I-100****3698 REV H 03/2023****Z000100PHB**

Victaulic and all other Victaulic marks are the trademarks or registered trademarks of Victaulic Company, and/or its affiliated entities, in the U.S. and/or other countries. All other trademarks listed herein are the property of their respective holders, in the U.S. and/or other countries. The terms "Patented" or "Patent Pending" refer to design or utility patents or patent applications for articles and/or methods of use in the United States and/or other countries.

