

THERMAGLASS

K-SERIES

ACRYLIC BASES

CD-SERIES

ACRYLIC BASES

Item No.

K-UT09-4832

K-UT09-4834

K-UT09-4836

K-UT09-6030R/L

K-UT09-6032R/L

K-UT09-6034

K-UT09-6036

K-UT10-3636-3

K-UT10-3636-2

CD-3636

CD-4832

CD-4834

CD-4836

CD-6030R/L

CD-6032R/L

CD-6034

CD-6036

K & CD Series Shower Bases

Installation Steps

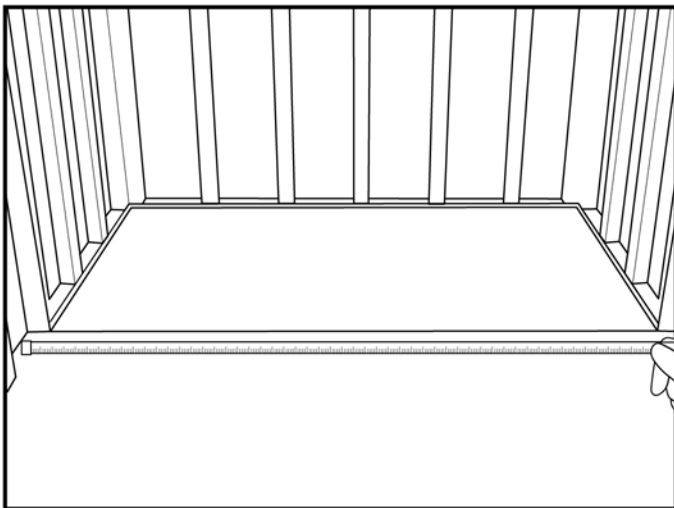

STEP 01: Measure the area where the shower base will be installed.

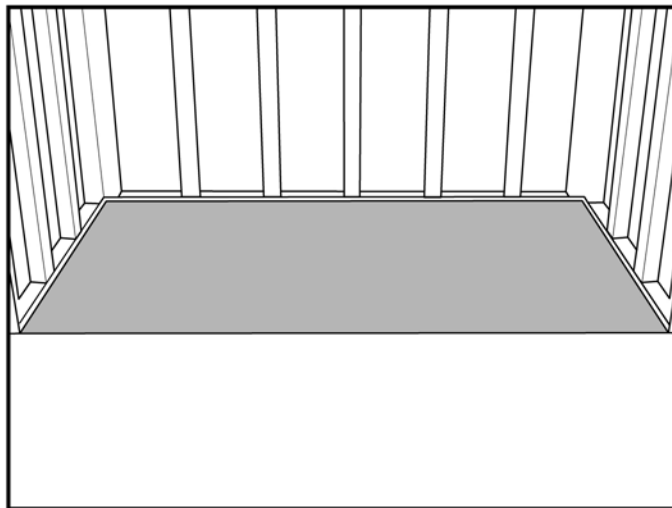

STEP 02: Cut tar paper to size and tack onto the sub floor.

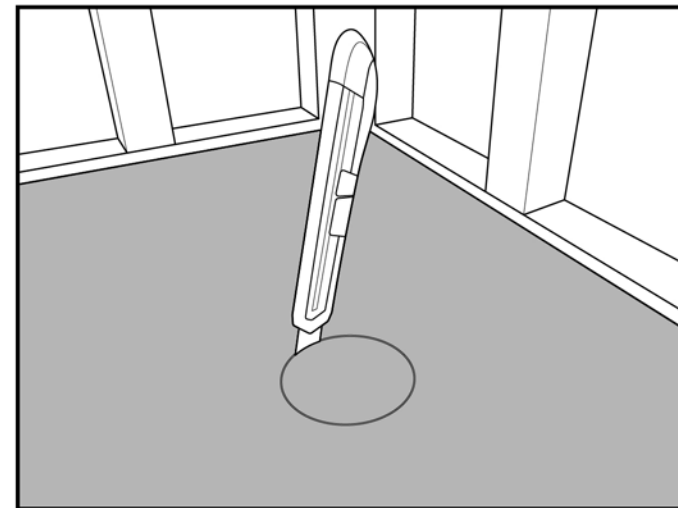

STEP 03: Cut out the drain hole and tack around the edges.

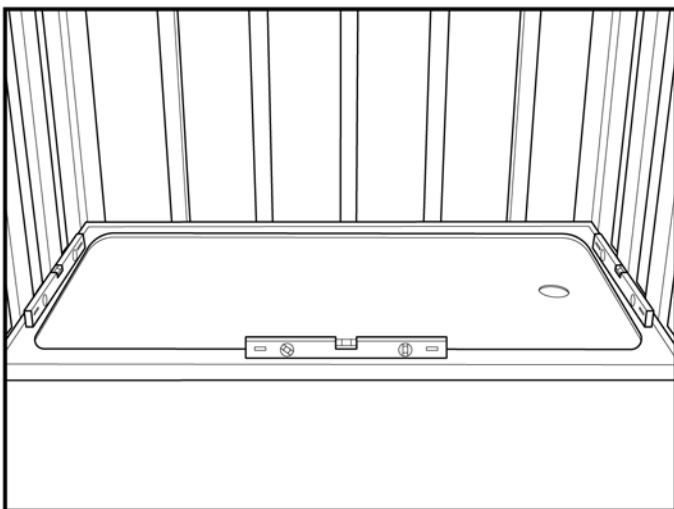

STEP 04: Dry fit the shower base and check to see if the subfloor is level.

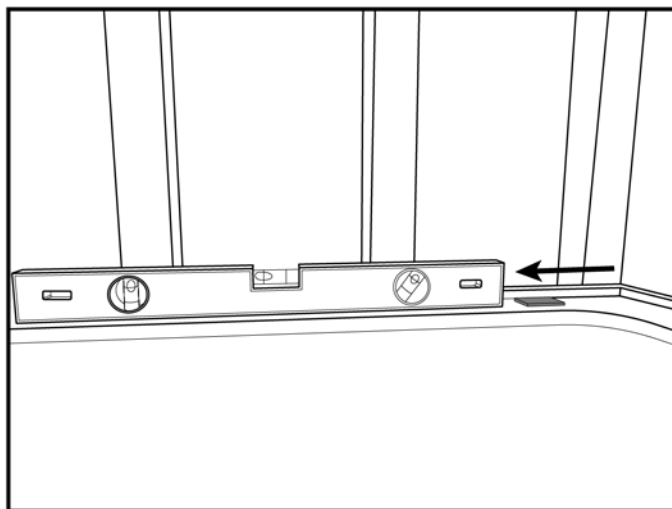

STEP 05: Use the level to determine the thickness of the shims required to level the shower base

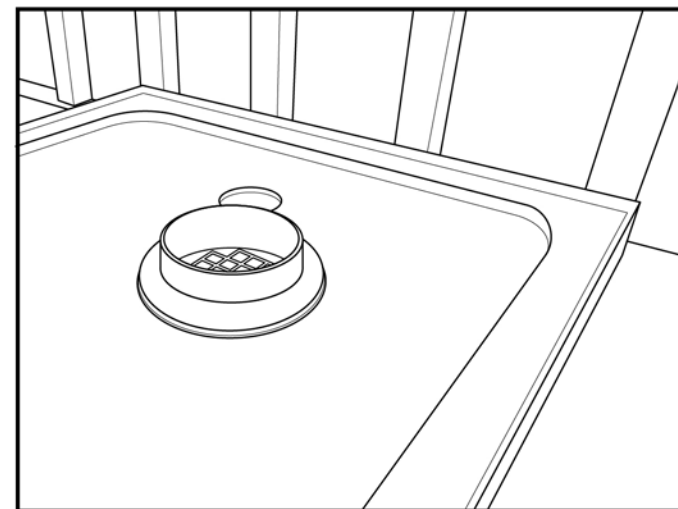

STEP 06: Apply silicone caulking to the underside of the drain flange.
Note drain not included with base.

Installation Process

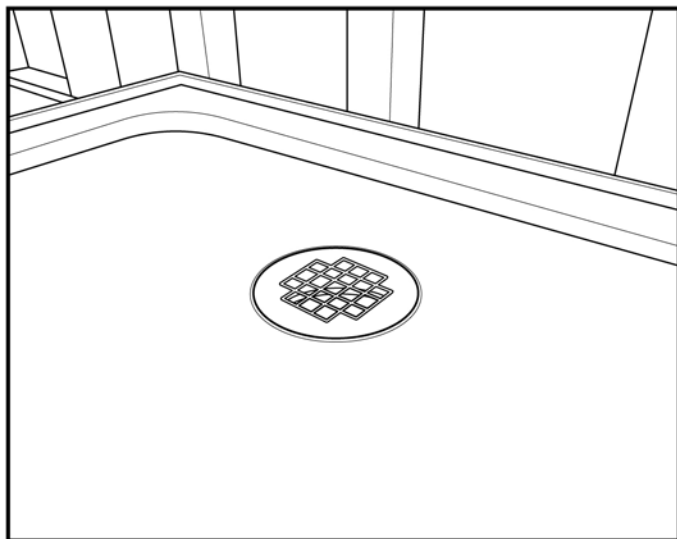

STEP 07: Insert the drain into the drain hole and remove any excess silicone.

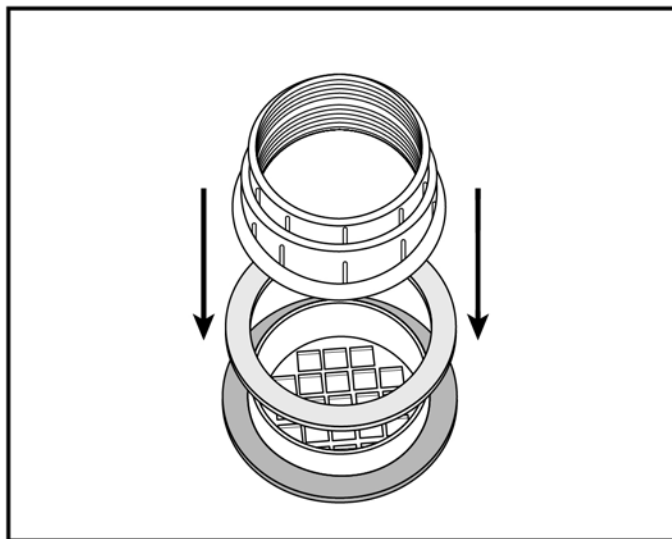

STEP 08: Install gaskets and tighten the nut on the bottom of the drain.

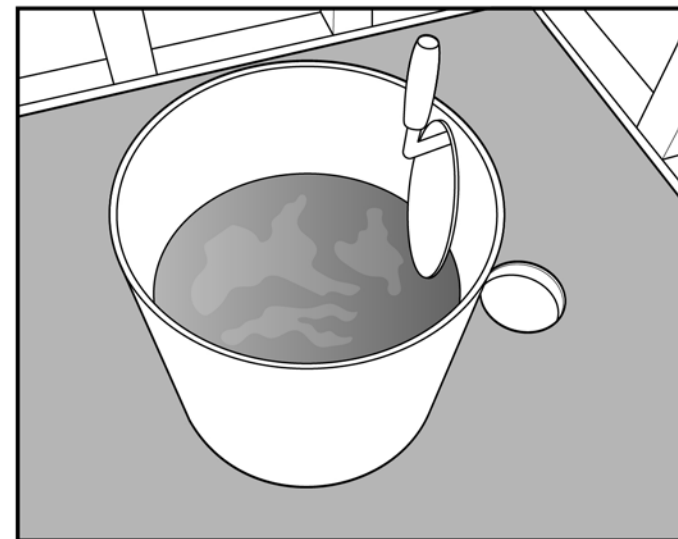

STEP 09: Mix a batch of stiff mortar.

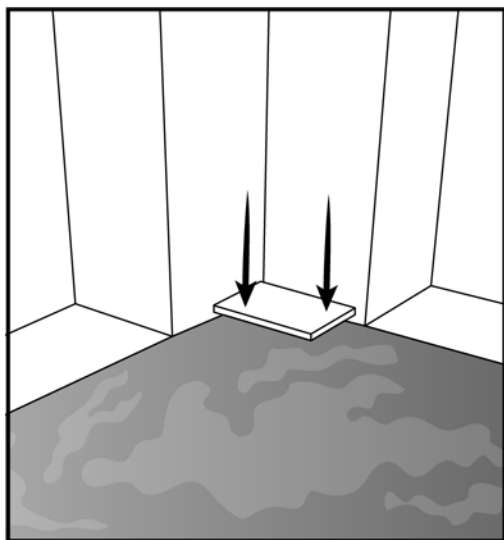

STEP 10: If needed place shims then spread mortar to a $\frac{1}{8}$ " thick sloping down to $\frac{1}{2}$ " on the drain side.

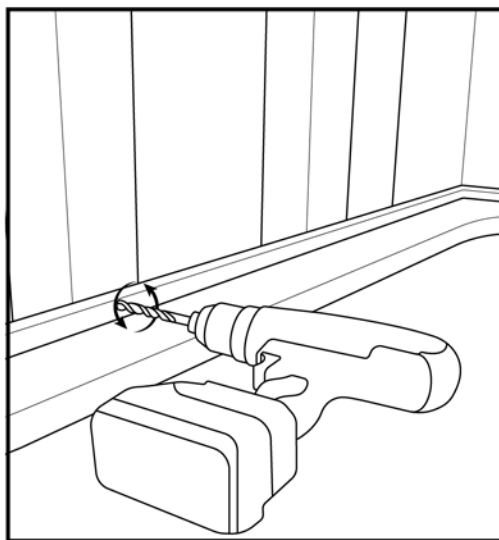

STEP 11: Drill pilot holes through the shower base flange into the studs.

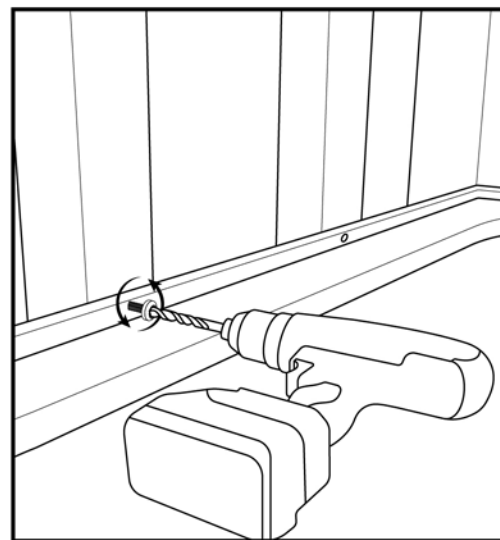

STEP 12: Insert screw and attach the shower base directly to the studs.

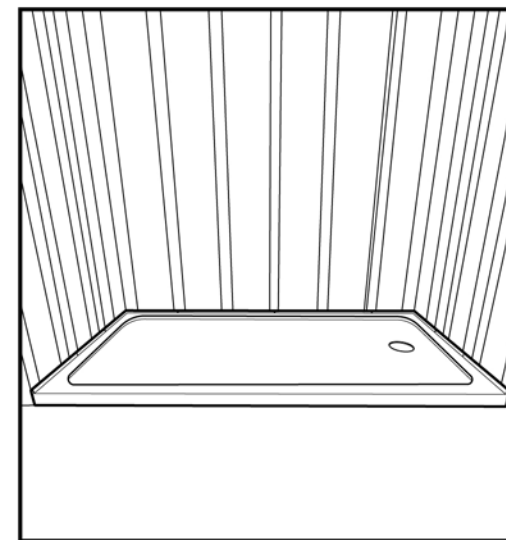

STEP 13: Allow 24 hours to set and dry.