

# Victaulic Balancing Valves

## TA Series 786H/787H/788/789 and Series 78KH



08.16



TA Series 786H



TA Series 787H



TA Series 78KH



TA Series 788



TA Series 789

### 1.0 PRODUCT DESCRIPTION

#### Available Sizes

- ½ – 16"/DN15 – DN400

#### Maximum Working Pressure

- Series 786H, 787H and 78KH: 400 psi/2758 kPa/27.6 bar
- Series 788: 250 psi/1724 kPa/17.2 bar
- Series 789: 350 psi/2413 kPa/24 bar

#### Operating Temperature

- -4°F to +248°F/-20°C to +120°C for 786H/787H/78KH
- +14°F to 248°F/-12°C to +120°C for 788/789 Valves

#### Application

- Heating (not including steam) and cooling systems

#### Function

- Balancing
- Pre-Setting
- Measuring
- Shut-Off
- Draining (when ordered with optional drain connection ½" through 2" sizes only)

### 2.0 CERTIFICATIONS/LISTINGS

Product manufactured by Victaulic and/or certified suppliers in accordance with ISO-9001.

ALWAYS REFER TO ANY NOTIFICATIONS AT THE END OF THIS DOCUMENT REGARDING PRODUCT INSTALLATION, MAINTENANCE OR SUPPORT.



### 3.0 SPECIFICATIONS – MATERIAL

---

#### TA Series 786H & 787H and Series 78KH

**Valve Body and Bonnet:** AMETAL® dezincification resistant (DZR) brass alloy

**Sealing (Body/Bonnet):** EPDM O-ring

**Valve Plug:** AMETAL®

**Seat Seal:** EPDM O-ring

**Spindle:** AMETAL®

**Slip Washer:** Polytetrafluoroethylene (PTFE)

**Spindle Seal:** EPDM O-ring

**Spring:** Stainless steel

**Hand Wheel:** Polyamide and TPE

**Measuring Points:** AMETAL®

**Measuring Point Seals:** EPDM

**Measuring Point Caps:** Polyamide and TPE

**Drain Kit Body:** AMETAL®

**Drain Kit Seals:** EPDM

**Drain Kit Gasket:** Fiber-based aramid

#### TA Series 788 & 789

**Body:** Ductile iron conforming to ASTM A536 Grade 60-40-18 (BS Grade 400/15)

**Body Coating:** 2 ½ – 8" – Epoxy painted; 10 – 16" – Painted

**Trim (Bonnet, Stem and Restriction Cone)**

Bonnet: 2 ½ – 6" – AMETAL®; 8 – 16" – Ductile iron

2 ½ – 6" Stem & Restriction Cone: AMETAL®

8 – 16" Cone – Ductile iron; 8 – 16" Spindle – AMETAL®

**Seat:** Ductile iron

**Seat Seal:** EPDM

**Stem Seal:** EPDM

**Probe Seal:** EPDM

**Handwheel:** 2 ½ – 6" – Red polyamide plastic; 8 – 16" – Aluminum

#### NOTE

- AMETAL® is the dezincification-resistant brass alloy of IMI TA

## 4.0 DIMENSIONS

### TA Series 786H Solder End

### TA Series 787H Female NPT Threaded End

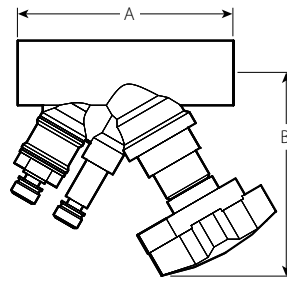

TA Series 786H  
½ – 2"/DN15 – DN50

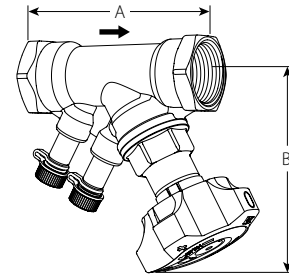

TA Series 787H  
½ – 2"/DN15 – DN50

Size		TA Series 786H Solder End (400 psi/2758 kPa)			TA Series 787H Female NPT Threaded End (400 psi/2758 kPa)			
Nominal inches DN	Actual Outside Diameter inches mm	A End to End Sweat X Sweat inches mm	B Center to Top inches mm	Approx. Weight (Each) lb kg	A End to End Female x Female inches mm	A End to End Female x Copper Press inches mm	B Center to Top inches mm	Approx. Weight (Each) lb kg
½ DN15	0.840 21.3	3.54 90	3.94 100	1.4 0.6	3.31 84	4.49 114	3.94 100	1.5 0.7
¾ DN20	1.050 26.9	3.82 98	3.94 100	1.4 0.6	3.70 94	5.08 130	3.94 100	1.6 0.7
1 DN25	1.315 33.7	4.33 110	4.13 104	1.9 0.9	4.13 104	5.62 142	4.13 104	2.0 0.9
1 ¼ DN32	1.660 42.4	4.88 124	4.13 104	2.4 1.1	4.76 120	6.41 162	4.13 104	2.6 1.2
1 ½ DN40	1.900 48.3	5.12 130	4.72 120	3.1 1.4	4.96 126	6.94 176	4.72 120	3.3 1.5
2 DN50	2.375 60.3	6.08 154	4.72 120	4.5 2.0	6.10 154	8.41 214	4.72 120	5.0 2.3

#### NOTES

- In softwares (HySelect, HyTools) and balancing instrument (TA-SCOPE) the TA Series 786H ½ – 2" is named STAS\*.
- In softwares (HySelect, HyTools) and balancing instrument (TA-SCOPE) the TA Series 787H ½ – 2" is named STAD\*.

## 4.1 DIMENSIONS

### Series 78KH Male NPT Union x Female NPT

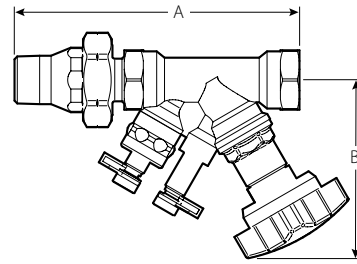

Series 78KH  
½ – 2"/DN15 – DN50

Size					Series 78KH Male NPT Union x Female NPT (400 psi/2758 kPa)				
Nominal inches mm		Actual Outside Diameter inches mm			A End to End Male x Female inches mm	A End to End Male x Copper Press inches mm	B Center to Top inches mm	Approx. Weight (Each) lb kg	
MPT Union	FPT Valve	MPT Union	FPT Valve						
½ DN15	x ½ DN15	0.840 21.3	x 0.840 21.3		5.28 134	6.45 164	3.94 100	1.7 0.8	
				¾ DN20	5.90 150	7.29 186	3.94 100	1.8 0.8	
				1 DN25	6.33 160	7.82 198	4.13 104	2.7 1.2	
				1 ¼ DN32	7.25 184	8.91 226	4.13 104	4.1 1.9	
¾ DN20	x ¾ DN20	1.050 26.9	x 1.050 26.9		5.90 150	7.29 186	3.94 100	2.3 1.0	
				1 DN25	6.34 162	7.82 198	4.13 104	2.2 1.0	
				1 ¼ DN32	7.25 184	8.90 226	4.13 104	4.3 2.0	
				1 ½ DN40	7.49 190	9.46 240	4.72 120	5.0 2.3	
1 DN25	x 1 DN25	1.315 33.7	x 1.315 33.7		6.45 164	7.93 202	4.13 104	4.0 1.8	
				1 ¼ DN32	7.25 184	8.91 226	4.13 104	2.8 1.3	
				1 ½ DN40	7.49 190	9.46 240	4.72 120	5.2 2.4	
				2 DN50	8.88 226	11.20 284	4.72 120	7.3 3.3	
1 ¼ DN32	x 1 ¼ DN32	1.660 42.4	x 1.660 42.4		7.25 184	8.91 226	4.13 104	5.5 2.5	
				1 ½ DN40	7.49 190	9.46 240	4.72 120	3.6 1.6	
				2 DN50	8.88 226	11.20 284	4.72 120	7.5 3.4	
1 ½ DN40	x 1 ½ DN40	1.900 48.3	x 1.900 48.3		7.70 196	9.67 246	4.72 120	7.2 3.3	
				2 DN50	8.88 226	11.20 284	4.72 120	5.3 2.4	
2 DN50	x 2 DN50	2.375 60.3	x 2.375 60.3		8.88 226	11.20 284	4.72 120	7.2 3.3	

#### NOTES

- Optional tailpiece options are available. See accessory table on pg. 5 for more information.
- In softwares (HySelect, HyTools) and balancing instrument (TA-SCOPE) the TA Series 78KH ½ – 2" is named STAD\*.

## 4.2 OPTIONAL PARTS

### Series 78KH Union Tailpieces (Optional)



Female Tailpiece

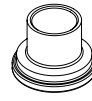

Sweat Tailpiece

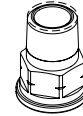

Male Tailpiece

Size		Victaulic Part Code		
Nominal <sup>1</sup> inches		Female Tailpiece	Sweat Tailpiece	Male Tailpiece
1/2	x 1/2	P00478Y304	P00478Y504	P00478U404
3/4	x 1/2	P00678Y304	P00678Y504	P00678U404
		P00678Y306	P00678Y506	P00678U406
1	x 1/2	P00678Y304	P00678Y504	P00678U404
		P00678Y306	P00678Y506	P00678U406
		P00678Y310	P00678Y510	P00678U410
1 1/4	x 1/2	–	–	P01278U404
		P01278Y306	P01278Y506	P01278U406
		P01278Y310	P01278Y510	P01278U410
		P01278Y312	P01278Y512	P01278U412
1 1/2	x 1/2	–	–	P01278U404
		P01278Y306	P01278Y506	P01278U406
		P01278Y310	P01278Y510	P01278U410
		P01278Y312	P01278Y512	P01278U412
		P01278Y314	P01278Y514	P01278U414
2	x 1	–	–	P02078U410
		P02078Y312	P01278Y512	P02078U412
		P02078Y314	P01278Y514	P02078U414
		P02078Y320	P02078Y520	P02078U420

<sup>1</sup> This table is for nominal valve size by outlet or inlet union size. For example: A 3/4 x 1/2" tailpiece is used to enlarge from 1/2" pipe to a 3/4" valve or to reduce an outlet from a 3/4" valve to 1/2". They are common components with other Victaulic valve families.

### 4.3 DIMENSIONS

#### TA Series 788 Flanged and 789 Grooved Ends (Class 150 RF, ASME/ANSI B16.42)

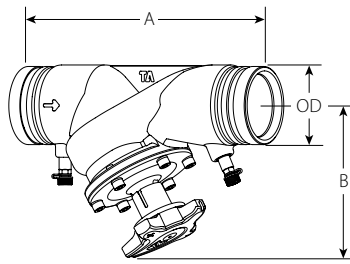

TA Series 789 Grooved  
2 ½ – 3"/DN65 – DN80

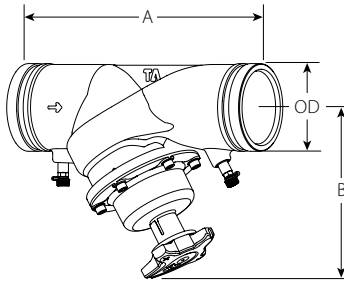

TA Series 789 Grooved  
4 – 6"/DN100 – DN150

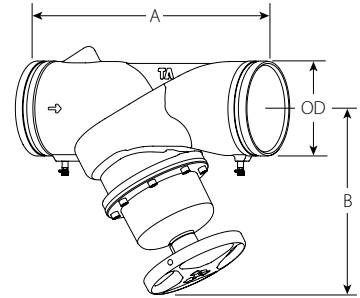

TA Series 789 Grooved  
8 – 12"/DN200 – DN300

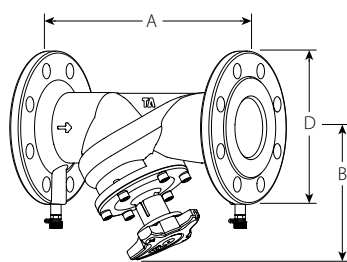

TA Series 788 Flanged  
2 ½ – 3"/DN65 – DN80

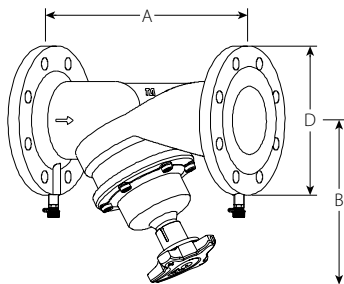

TA Series 788 Flanged  
4 – 6"/DN100 – DN150

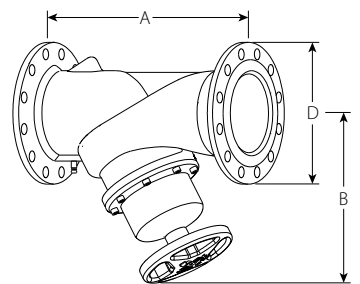

TA Series 788 Flanged  
8 – 12"/DN200 – DN300

Size		TA Series 788 Flanged End (250 psi/1724 kPa)				TA Series 789 Grooved End (350 psi/2413 kPa)		
Nominal inches DN	Actual Outside Diameter inches mm	A End to End inches mm	B Center Top inches mm	D inches mm	Approx. Weight (Each) lb kg	A End to End inches mm	B Center Top inches mm	Approx. Weight (Each) lb kg
2 ½	2.875 73.0	11.42 290	8.07 204	7.09 180	24.3 11.0	11.42 290	8.07 204	14.1 6.4
3 DN80	3.500 88.9	12.20 310	8.66 220	7.48 190	30.9 14.0	12.20 310	8.66 220	20.1 9.1
4 DN100	4.500 114.3	13.78 350	9.45 240	9.06 230	43.2 19.6	13.78 350	9.45 240	30.9 14.0
5	5.563 141.3	15.75 400	10.83 276	10.04 256	61.9 28.1	15.75 400	10.83 276	50.0 22.7
6 DN150	6.625 168.3	18.90 480	11.22 284	11.02 280	81.8 37.1	18.90 480	11.22 284	69.0 31.3
8 DN200	8.625 219.1	23.62 600	16.93 430	13.58 344	167.5 76.0	23.62 600	16.93 430	140.0 63.5
10 DN250	10.750 273.0	28.74 730	16.54 420	15.98 406	269.0 122.0	28.74 730	16.54 420	203.0 92.1
12 DN300	12.750 323.9	33.46 850	18.90 480	19.02 484	359.4 163.0	33.45 850	18.90 480	280.0 127.0
14 DN350	14.000 355.6	38.58 980	23.03 584	20.98 532	654.8 297.0	-	-	-
16 DN400	16.000 406.4	43.31 1100	25.20 640	23.50 596	895.1 406.0	-	-	-

**NOTES**

- In softwares (HySelect, HyTools) and balancing instrument (TA-SCOPE) the TA Series 789 2 ½ – 6" is named STAG.
- In softwares (HySelect, HyTools) and balancing instrument (TA-SCOPE) the TA Series 788 2 ½ – 6" is named STAF-SG.

## 5.0 PERFORMANCE

### Valve Selection Guide – TA Series 786H & 787H and Series 78KH

Size		Flow Data for TA Series 786H & 787H and Series 78KH		
Nominal inches DN	Actual Outside Diameter inches mm	Absolute Min. Flow GPM LPM	Nominal Range of Flow GPM LPM	Absolute Max. Flow GPM LPM
½ DN15	0.840 21.3	0.1 0.5	0.6 – 2.8 2.3 – 10.6	8.6 32.6
¾ DN20	1.050 26.9	0.4 1.5	2.0 – 6.0 7.6 – 22.7	20.0 76.0
1 DN25	1.315 33.7	0.5 1.7	3.9 – 10.0 14.8 – 37.9	30.0 114.0
1 ¼ DN32	1.660 42.4	0.9 3.3	5.0 – 15.0 18.9 – 56.8	48.0 182.0
1 ½ DN40	1.900 48.3	1.3 4.9	6.6 – 20.0 25.0 – 75.7	66.0 250.0
2 DN50	2.375 60.3	2.0 7.6	12.6 – 36.0 47.7 – 136.0	110.0 416.0

#### Important Notes

Balancing valves should be sized in accordance with the GPM/LPM flows (and not in relation to pipeline size). Sizing balancing valves based on the minimum or maximum flow rates is not recommended. Valves should be sized using the nominal flow rate only. The Minimum Flow is calculated from the minimum open setting of the valve and a minimum pressure drop 1 Ft. WG (= 3 kPa). The Nominal Flow is calculated from the maximum open setting of the valve and the minimum recommended pressure drop, 2 Ft. WG (= 6 kPa). The Maximum Flow is calculated from the maximum open setting of the valve and the maximum pressure drop, 20 Ft. WG (= 60 kPa). A computer program, TA-Select, is available for calculation of valve handwheel pre-set position and other applications.

#### Measuring Accuracy

The hand wheel zero position is calibrated and must not be changed. Valves have an accuracy of flow measurement of 2% to 3% when used within their recommended flow range and installed in accordance with the figure below.

#### NOTE

- For the most accurate results, a Series 734 TA SCOPE should be used. However, any differential pressure meter may be used.

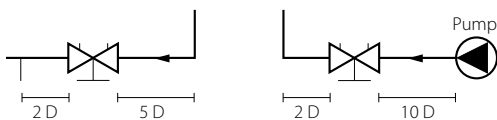

The illustration relates to the accuracy of differential pressure measurement and is not an installation requirement.

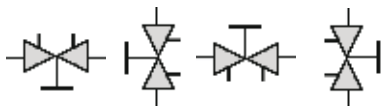

Valve may be installed in any orientation. For optimal flow accuracy, the valve should be installed with the handle towards the downstream end. Please note when used as a partner valve with 793 differential pressure control valve, flow direction should be reversed.

## 5.1 PERFORMANCE

### C<sub>v</sub> Values for Various Handle Settings

#### TA Series 786H

The values below may be used when calculating and sizing a piping system.

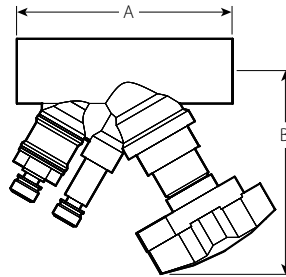

TA Series 786H

C <sub>v</sub> Values for Sizes listed below <sup>1</sup>							
No. of Turns	½"	¾"	1"	1 ¼"	1 ½"	2"	
0.50	0.157	0.616	0.693	1.38	2.19	3.03	
1.00	0.261	0.903	1.19	2.42	3.93	4.74	
1.50	0.401	1.41	2.46	3.88	5.48	7.82	
2.00	0.714	2.25	4.21	6.03	7.23	13.2	
2.50	1.08	3.13	6.08	8.98	10.6	18.3	
3.00	1.69	4.29	7.69	11.4	14.8	24.9	
3.50	2.39	5.21	9.01	13.8	18.7	31.2	
4.00 <sup>2</sup>	2.96	6.23	9.93	16.4	22.3	37.3	

<sup>1</sup> C<sub>v</sub> = GPM at a ΔP of 1 psi/7 kPa through the valve at any given setting.  
1 psi = 2.31 ft. of H<sub>2</sub>O

<sup>2</sup> Full open valve.

#### TA Series 787H and Series 78KH

The values below may be used when calculating and sizing a piping system.

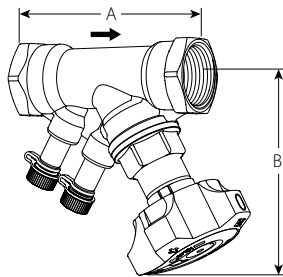

TA Series 787H

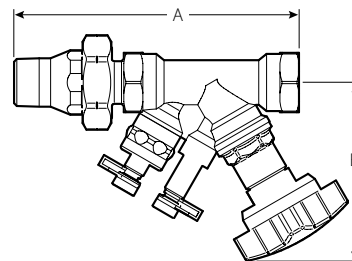

TA Series 78KH

C <sub>v</sub> Values for Sizes listed below <sup>1</sup>							
No. of Turns	½"	¾"	1"	1 ¼"	1 ½"	2"	
0.50	0.157	0.616	0.693	1.38	2.19	3.03	
1.00	0.261	0.903	1.19	2.42	3.93	4.74	
1.50	0.401	1.41	2.46	3.88	5.48	7.82	
2.00	0.714	2.25	4.21	6.03	7.23	13.2	
2.50	1.08	3.13	6.08	8.98	10.6	18.3	
3.00	1.69	4.29	7.69	11.4	14.8	24.9	
3.50	2.39	5.21	9.01	13.8	18.7	31.2	
4.00 <sup>2</sup>	2.96	6.23	9.93	16.4	22.3	37.3	

<sup>1</sup> C<sub>v</sub> = GPM at a ΔP of 1 psi/7 kPa through the valve at any given setting.  
1 psi = 2.31 ft. of H<sub>2</sub>O

<sup>2</sup> Full open valve.

## 5.2 PERFORMANCE

### Valve Selection Guide – TA Series 788 & 789

Size		Flow Data for TA Series 788 & 789		
Nominal inches DN	Actual Outside Diameter inches mm	Absolute Min. Flow GPM LPM	Nominal Range of Flow GPM LPM	Absolute Max. Flow GPM LPM
2 ½	2.875 73.0	1.4 5.3	21.0 – 91.0 78.0 – 345.0	290.0 1097.7
3 DN80	3.500 88.9	1.5 5.7	32.0 – 133.0 121.0 – 504.0	410.0 1551.9
4 DN100	4.500 114.3	1.9 7.2	68.0 – 200.0 257.0 – 757.0	650.0 2460.3
5 DN125	5.563 141.3	4.2 15.9	90.0 – 320.0 341.0 – 1211.0	1020.0 3860.7
6 DN150	6.625 168.3	5.0 18.9	182.0 – 450.0 689.0 – 1703.0	1430.0 5412.6
8 DN200	8.625 219.1	30.0 113.6	367.0 – 820.0 1389.0 – 3104.0	2600.0 9841.0
10 DN250	10.750 273.0	70.0 265.0	540.0 – 1300.0 2044.0 – 4921.0	4040.0 15291.4
12 DN300	12.750 323.9	115.0 435.3	960.0 – 1500.0 3634.0 – 5678.0	4950.0 18735.8
14 <sup>3</sup> DN350	14.000 355.6	83.0 314.0	1020.0 – 2700.0 3861.0 – 10220.0	7414.0 28062.0
16 <sup>3</sup> DN400	16.000 406.4	95.0 360.0	1330.0 – 3400.0 5034.0 – 12869.0	9371.0 35469.0

<sup>3</sup> Only the TA Series 788 Flanged End Balancing Valves is available in 14 – 16"/DN350 – DN400 sizes.

#### Important Notes

Balancing valves should be sized in accordance with the GPM/LPM flows (and not in relation to pipeline size). Sizing balancing valves based on the minimum or maximum flow rates is not recommended. Valves should be sized using the nominal flow rate only. The Minimum Flow is calculated from the minimum open setting of the valve and a minimum pressure drop 1 Ft. WG (= 3 kPa). The Nominal Flow is calculated from the maximum open setting of the valve and the minimum recommended pressure drop, 2 Ft. WG (= 6 kPa). The Maximum Flow is calculated from the maximum open setting of the valve and the maximum pressure drop, 20 Ft. WG (= 60 kPa). A computer program, TA-Select, is available for calculation of valve handwheel pre-set position and other applications.

#### NOTE

- For the most accurate results, a Series 734 TA SCOPE should be used. However, any differential pressure meter may be used.

### 5.3 PERFORMANCE

#### C<sub>v</sub> Values for Various Handle Settings

#### TA Series 788 & 789

The values below may be used when calculating and sizing a piping system.

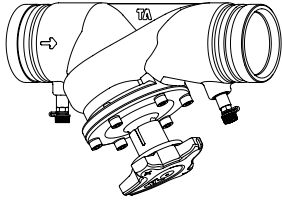

TA Series 789 Grooved  
2 ½ – 3"/DN65 – DN80

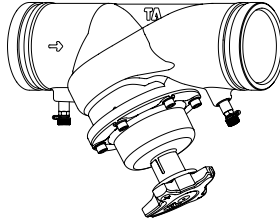

TA Series 789 Grooved  
4 – 6"/DN100 – DN150

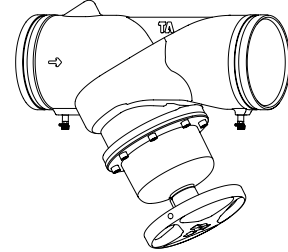

TA Series 789 Grooved  
8 – 12"/DN200 – DN300

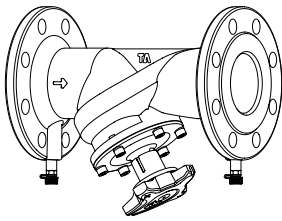

TA Series 788 Flanged  
2 ½ – 3"/DN65 – DN80

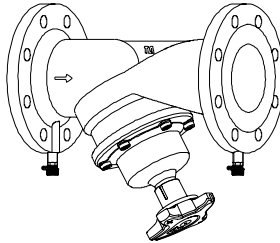

TA Series 788 Flanged  
4 – 6"/DN100 – DN150

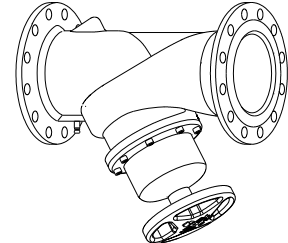

TA Series 788 Flanged  
8 – 12"/DN200 – DN300

C <sub>v</sub> Values for Sizes listed below <sup>4</sup>										
No. of Turns	2 ½"	3"	4"	5"	6"	8"	10"	12"	14" <sup>5</sup>	16" <sup>5</sup>
0.50	1.18	2.69	2.94	6.92	6.24	–	–	–	–	–
1.00	2.76	4.92	6.47	12.6	15.4	–	–	–	–	–
1.50	4.36	7.17	9.98	18.1	26.3	–	–	–	–	–
2.00	5.99	9.80	13.3	24.8	47.4	46.4	104	–	–	–
2.50	7.53	13.2	18.0	33.7	76.0	58.0	128	–	–	–
3.00	9.46	17.4	30.2	43.4	107	75.4	162	174	126	145
3.50	13.4	24.1	49.5	62.6	147	104	226	267	150	172
4.00	21.5	34.6	76.3	98.4	204	139	296	348	172	198
4.50	34.5	50.0	106	136	247	191	371	429	197	241
5.00	45.8	66.5	125	171	288	261	447	522	240	306
5.50	55.3	80.4	137	194	325	331	516	621	295	378
6.00	66.4	93.8	157	229	354	394	580	719	350	448
6.50	76.7	107	175	268	384	464	632	800	408	521
7.00	85.8	120	189	295	408	505	684	870	469	597
7.50	92.5	132	202	318	433	545	766	945	546	684
8.00	98.3	142	214	340	462	597	841	1032	645	789

Continued on Page 11

<sup>4</sup> C<sub>v</sub> = GPM at a ΔP of 1 psi/7 kPa through the valve at any given setting.  
1 psi = 2.31 ft. of H<sub>2</sub>O

<sup>5</sup> Only the TA Series 788 Flanged End Balancing Valve is available in 14 – 16"/DN350 – DN400 sizes.

<sup>6</sup> Full open valve.

5.3 PERFORMANCE (CONTINUED)

C<sub>v</sub> Values for Various Handle Settings

TA Series 788 & 789

The values below may be used when calculating and sizing a piping system.

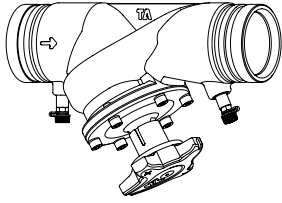

TA Series 789 Grooved  
2 ½ – 3"/DN65 – DN80

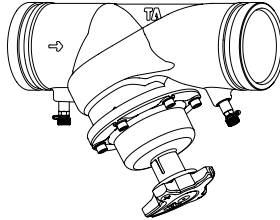

TA Series 789 Grooved  
4 – 6"/DN100 – DN150

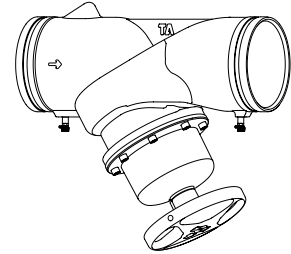

TA Series 789 Grooved  
8 – 12"/DN200 – DN300

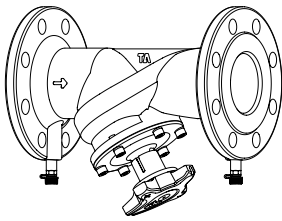

TA Series 788 Flanged  
2 ½ – 3"/DN65 – DN80

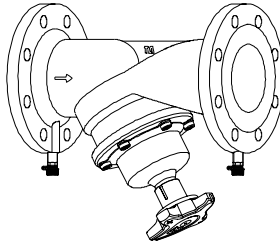

TA Series 788 Flanged  
4 – 6"/DN100 – DN150

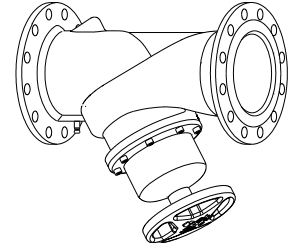

TA Series 788 Flanged  
8 – 12"/DN200 – DN300

C <sub>v</sub> Values for Sizes listed below <sup>4</sup>										
No. of Turns	2 ½"	3"	4"	5"	6"	8"	10"	12"	14" <sup>5</sup>	16" <sup>5</sup>
9.00	–	–	–	–	–	690	951	1125	909	1037
10.00	–	–	–	–	–	754	1090	1206	1110	1322
11.00	–	–	–	–	–	824	1218	1299	1276	1450
12.00	–	–	–	–	–	887 <sup>6</sup>	1375 <sup>6</sup>	1392	1462	1624
13.00	–	–	–	–	–	–	–	1531	1647	1810
14.00	–	–	–	–	–	–	–	1589	1868	2007
15.00	–	–	–	–	–	–	–	1624	2042	2250
16.00	–	–	–	–	–	–	–	1682 <sup>6</sup>	2169	2482
17.00	–	–	–	–	–	–	–	–	2274	2645
18.00	–	–	–	–	–	–	–	–	2366	2796
19.00	–	–	–	–	–	–	–	–	2471	2935
20.00	–	–	–	–	–	–	–	–	2552 <sup>6</sup>	3051
21.00	–	–	–	–	–	–	–	–	–	3144
22.00	–	–	–	–	–	–	–	–	–	3225 <sup>6</sup>
22.00	–	–	–	–	–	–	–	–	–	3225 <sup>6</sup>

<sup>4</sup> C<sub>v</sub> = GPM at a ΔP of 1 psi/7 kPa through the valve at any given setting.  
1 psi = 2.31 ft. of H<sub>2</sub>O

<sup>5</sup> Only the TA Series 788 Flanged End Balancing Valve is available in 14 – 16"/DN350 – DN400 sizes.

<sup>6</sup> Full open v

---

## 5.4 PERFORMANCE

---

### Correction Factors

For liquids other than water, the flow values from the balancing wheel can be adjusted as follows:  
Divide the flow rate (as indicated by the balancing wheel) by the square root of the specific gravity.

$$\text{Actual Flow} = \frac{q_{\text{Calculated}}}{\sqrt{SG}}$$

This applies to liquids having, on the whole, the same viscosity as water, i.e. most water/glycol mixtures and water/brine solutions at room temperature. At low temperatures, the viscosity increases and laminar flow may occur in certain valves. The risk increases with small valves, low settings and low differential pressures.

A computer program, HySelect, is available for calculation of pre-setting values and other applications. When the flow setting is verified or changed to the final setting, the memory stop should be set. Also, the TA Scope can automatically make this conversion by programming the properties of the fluid being used. Contact Victaulic for further information.

### Correction Factors

When  $\Delta p$  and the design flow rate are known, use the formula shown to calculate the CV value. The balancing wheel can also be used.

$$C_v = 1.52 \frac{q}{\sqrt{\Delta p}}$$

q in GPM,  $\Delta p$  in Ft. of H<sub>2</sub>O

$$C_v = \frac{q}{\sqrt{\Delta p}}$$

q in GPM,  $\Delta p$  in psi

A computer program, HySelect, is available from Victaulic for calculation of pre-setting values and other applications. When measuring pressure drop across the Series 788 or 789 valves installed in the vertical position, the measured value should be adjusted by the static head created by the distance between the PT ports.

**NOTE:**

- suitable for water-glycol mixtures to 57%

## 5.5 PERFORMANCE

### Accessories

#### Drain Kit Series 786-DK

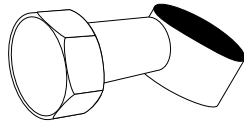

- A separate drain kit with a 3/4"/20 mm connection is available for Series 786H valves.
- Kit must be field mounted
- Kit comes complete with 2 gaskets and a hexnut.
- Partcode= K000786CBV

#### NOTE

- If a drain is needed for a Series 787H or a Series 78KH, be sure to choose the valve assembly with the factory installed option. Standard Series 787H or Series 78KH valves cannot be field retrofitted.

### Probe Port

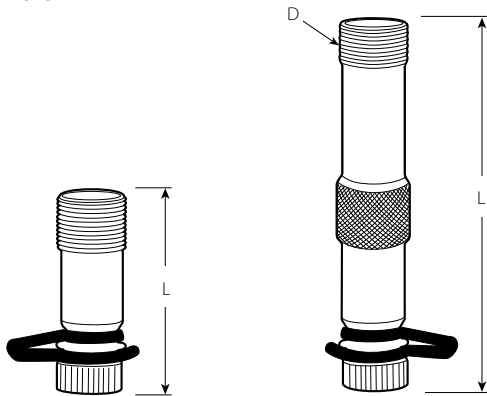

TA Series 786H/787H/788/789

TA Series 788/789

Series	Size inches mm	L inches mm	D	Part Code
786H/787H/78KH	1/2 – 2 15 – 50	1.75 45	M14x1	K000740003 <sup>7</sup>
788/789	2 1/2 – 16 65 – 400	1.19 30	R <sup>3/8</sup>	K000740002 <sup>8</sup>
788/789	2 1/2 – 16 65 – 400	3.50 89		K000740001 <sup>8</sup>

<sup>7</sup> When ordering, the partcode includes one probe port only. Each valve requires two probe ports.

<sup>8</sup> When ordering, the partcode includes a kit of two probe ports. Each valve requires a single kit only.

### PT Extension for 786H, 787H, and 78KH valves

Size inches mm	L inches mm	Part Code
1/2 – 2 15 – 50	2.8 71.1	P0007862PT

### Spindle Extension for 788 and 789

- The spindle can be extended on sizes 2 1/2 – 6" to make more room for insulation if needed. An extension kit is included with the 2 1/2 – 6" valves.
- Required to be installed on 2 1/2 – 6" sizes when using TA prefab insulation kits.

For Sizes	Part Code
2 1/2 – 6"	P024788EXT

## 5.5 PERFORMANCE (CONTINUED)

### Universal Gauge Meter Conversion Kit

- This kit is required to measure TA valves with third party differential pressure meters. It includes 2 probes, the necessary fittings, a flow wheel, and an instructions sheet.
- Partcode= K000738100

### Flow Setting Wheel

- For manual calculation of flow from hand wheel setting and differential pressure measurement
- ½" – 16"
- Partcode= K000740000

### Hand Wheels

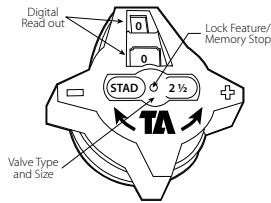

TA Series 786/787H/78KH  
Plastic  
½ – 2"

Part Code
P004784001

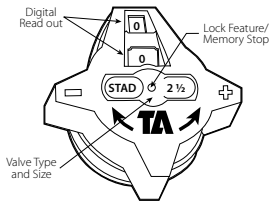

TA Series 788/789  
Plastic  
2 ½ – 6" (Legacy)

Part Code
P024784001

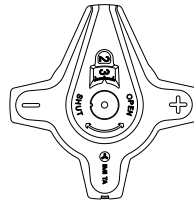

TA Series 788/789  
Plastic  
2 ½ – 6" (Current)

Part Code
P024788HDL

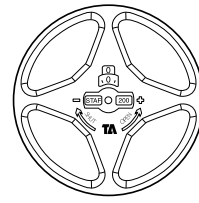

TA Series 788/789  
Aluminum  
8 – 16"

Part Code
P080784001

### Allen Wrench Sizes

½ – 2" Series 786, 787H and 78KH: 3 mm memory stop setting screw

2 ½ – 12" Series 788 & 2 ½ – 6" Series 789: 5 mm memory stop setting screw

8 – 16" Series 789: 8 mm memory stop setting screw

PT Ports: 5 mm

### Replacement O-Rings

Valve Size inches	Part Code*
½	P004799ORG
¾ – 1	P006799ORG
1 ¼ – 1 ½	P012799ORG
2"	P020799ORG

#### NOTE

\* The part codes listed in this column represent one (1) O-ring. However, O-rings are only sold in multiples of ten (10) and must be ordered in multiples of ten (10).

5.5 PERFORMANCE (CONTINUED)

Prefab Insulation

TA Series 786H & TA Series 787H

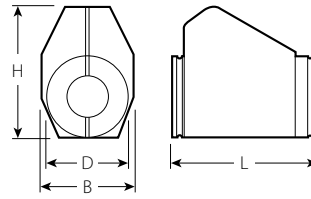

Valve Size inches mm	Part Code inches mm	Dimensions			
		H inches mm	D inches mm	B inches mm	L inches mm
½ & ¾ 15 & 20	K-004-784-INS	5.31 135	3.54 90	4.06 103	5.51 140
1 25	K-010-784-INS	5.59 142	3.70 94	4.06 103	6.30 160
1 ¼ 32	K-012-784-INS	6.14 156	4.17 106	4.06 103	7.09 180
1 ½ 40	K-014-784-INS	6.65 169	4.25 108	4.45 113	8.43 214
2 50	K-020-784-INS	7.01 178	4.25 108	4.49 114	9.65 245

Prefab Insulation

TA Series 788 & TA Series 789

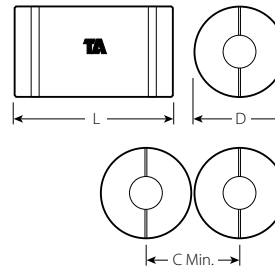

Valve Size inches mm	Part Code inches mm	Dimensions		
		L inches mm	D inches mm	C Min inches mm
2 ½ 65	K-024-784-INS	17.75 451	10.63 270	10.63 270
3 80	K-030-784-INS	19.00 483	11.44 291	11.44 291
4 100	K-040-784-INS	20.50 521	12.63 321	12.63 321
5 125	K-050-784-INS	22.50 572	13.75 349	13.75 349
6 150	K-060-784-INS	26.00 660	15.00 381	15.00 381

## 5.6 PERFORMANCE

---

### TA Series 734 Scope



The TA Series 734 SCOPE is a wireless, handheld device for the swift and accurate measurement of differential pressure, flow, temperature and power.

An independent sensor communicates with the TA SCOPE to deliver data quickly, thereby enabling contractors to balance a system, troubleshoot hydronic problems and log system performance.

The TA Series 734 SCOPE Premium is a more robust case compared to the TA Series 734 SCOPE. See page 15 of this publication for additional details on the TA SCOPE and TA SCOPE Premium.

#### Differential pressure

- TA SCOPE: 0-29 psi/0-200 kPa
- TA SCOPE (High Pressure): 0-145 psi/0-1000 kPa

### TA Series 736 Differential Pressure Sensor



Provides connection between a building's heating/cooling system and building monitoring system (BMS).

- Continuously measures differential pressure through and across the IMI TA balancing valves.
- Measurement probes provided for direct connection to the measurement points on all TA Series 786H, 787H, 788, and 789 balancing valves.

## 5.6 PERFORMANCE (CONTINUED)

### TA Series 734 Scope/Scope Premium

The TA Series 734 Scope contains a reduced set of accessories compared to the TA Series 734 Scope Premium. All parts marked with an asterisk (\*) in the list below are included in both the Scope and the Scope Premium kits. All other parts are only available in the Scope Premium kit.

1. \*Handheld unit (Hh)
2. \*Dp Sensor unit (DpS)
3. \*Digital Temperature Sensor (DTS)
4. \*Measuring hoses, 20 in. red/blue
5. Safety pressure and temperature probe (SPTP)
6. Safety pressure probes (SPP)
7. Measuring hoses with twin needle, 5.9 in
8. Flashlight
9. Mirror
10. Chucks for older valves, red/blue
11. \*Allen keys 3mm/5mm
12. Spanner for measuring points on older valves
13. \*Presetting tool TA Series TC/TCM/TCP
14. \*Spare filters (4 pcs)
15. Chain for mounting
16. Neckstrap
17. \*USB cables for connection: Hh - DpS and Hh - PC
18. \*Multi-charger for handheld, Dp sensor(s) and TA Series 734 Scope Relays
19. \*DC cable (2 PCS)
20. \*AC cable (EU, UK, US or AU.NZ)
21. Cable wrapping
22. \*Case
23. HySelect Software
24. User manual
25. \*Calibration certificates for DpS, DTS, and SPTP
26. \*Quick Guide
27. SPTP/SPP instruction
28. SPTP/SPP stickers

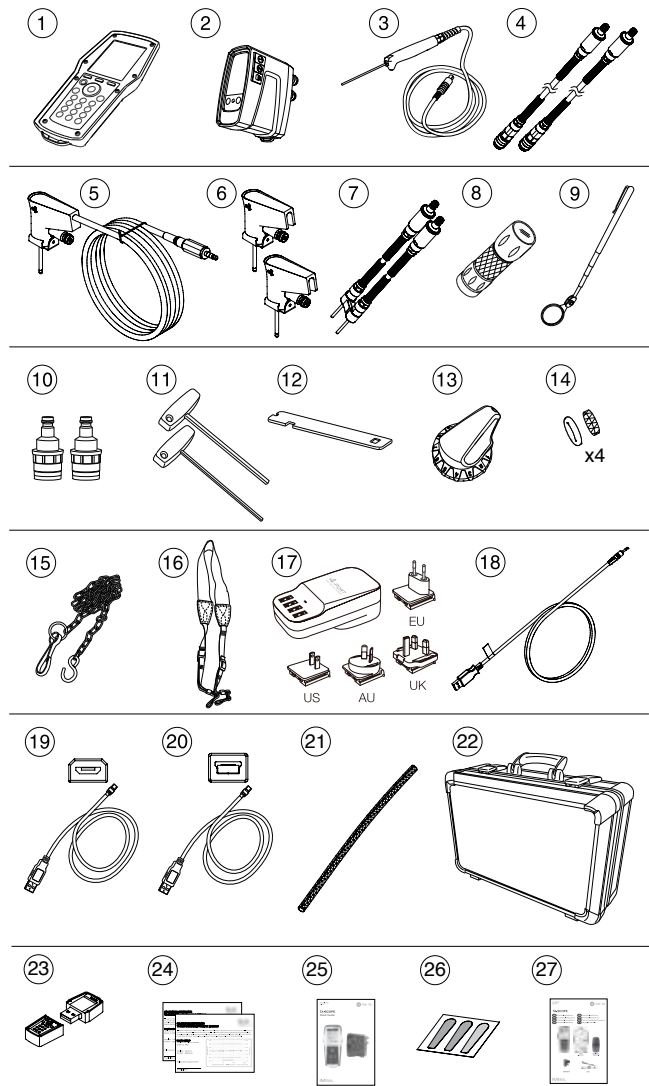

## 6.0 NOTIFICATIONS

### ⚠ WARNING



- Read and understand all instructions before attempting to install any Victaulic products.
- Always verify that the piping system has been completely depressurized and drained immediately prior to installation, removal, adjustment, or maintenance of any Victaulic products.
- Confirm that any equipment, branch lines, or sections of piping that may have been isolated for/during testing or due to valve closures/positioning are identified, depressurized, and drained immediately prior to installation, removal, adjustment, or maintenance of any Victaulic products.
- Wear safety glasses, hardhat, foot protection, and hearing protection.

Failure to follow these instructions could result in death or serious personal injury and property damage.

## 7.0 REFERENCE MATERIALS

[08.29: Victaulic Differential Pressure Controller - TA Series 793/794](#)

[08.30: Victaulic KOIL-KIT Coil Pack](#)

[08.34: Victaulic Automatic Balancing Valves - Series 76T, 76B, 76K, 76V & 76G](#)

[08.37: Victaulic Compact Pressure Independent Balancing and Control Valve \(Compact P\) - TA Series 7CP](#)

[08.38: Victaulic TBV Terminal Balancing and Control Valves - Series TC & Series TCM](#)

[08.46: Victaulic Differential pressure Controller - TA Series 7PR](#)

[08.47 Victaulic Compact Differential Pressure Control TA Series 7DA](#)

[08.55: Victaulic Pressure Independent Balancing and Modulating Control Valve - TA Series 7MP](#)

[08.57 Victaulic Differential Pressure Relief Valve TA Series 782](#)

### User Responsibility for Product Selection and Suitability

Each user bears final responsibility for determining the suitability of Victaulic products for their end-use application, in accordance with industry standards, project specifications, and Victaulic's published performance, maintenance, and safety data, as well as all warnings and installation instructions. Nothing in this or any other document, nor any verbal recommendation, advice, or opinion from any Victaulic employee, shall be deemed to alter, vary, supersede, or waive any provision of Victaulic Company's standard conditions of sale, warranty, installation instructions, or this disclaimer.

### Installation

Always refer to and follow the [Victaulic Installation Handbook](#) or installation instructions for the product you are installing. Handbooks are included with each shipment of Victaulic products, providing complete installation and assembly data, and are available in PDF format on our website at [victaulic.com](#).

### Warranty

Refer to the Warranty section of the current Price List or contact Victaulic for details.

### Intellectual Property Rights

No statement concerning the use of any material, product, service, or design is intended, or should be construed, to grant any license under any patent or other intellectual property right of Victaulic or any of its affiliates, or as a recommendation for the use of such material, product, service, or design in the infringement of any patent or other intellectual property right. The terms "Patented" or "Patent Pending" refer to design or utility patents or patent applications for articles and/or methods of use in the United States and/or other countries. Victaulic and all other Victaulic marks are the trademarks or registered trademarks of Victaulic Company, and/or its affiliated entities, in the U.S. and/or other countries.

### Note

All products bearing a Victaulic trademark are manufactured by Victaulic or to Victaulic specifications. All products are to be installed only in accordance with the applicable Victaulic installation instructions. Victaulic reserves the right to change product specifications, designs and standard equipment without notice and without incurring obligations.