

Optically Isolated USB CW Keying Interface, using a CH-340G USB-to-Serial converter module.

(N5IB -- 25 Sept 2020)

Operating with N3FJP logging software and an Elecraft K2 transceiver.

Connected to a PC's USB port, the CH-340G module appears as a serial communications (COM) port. The N3FJP software uses the Request-to-Send (RTS) line to key the CW characters. An optical isolator (4N25) provides DC isolation between the radio and PC.

The CH340G type USB interface was selected because I have had no problems with drivers for this chip on Windows 7, 8, or 10 PCs. This particular module was chosen because it was very inexpensive, can operate at either 5V or 3.3V logic levels (jumper selected), and it breaks out the RTS and CTS lines in a convenient manner. URLs for Amazon and eBay vendors are shown below

The output key lines can be connected in parallel with a straight key, bug, or cootie. In the case of the K2, diode connections to the radio's dit and dah paddle inputs allows seamless transition between straight key, iambic keyer, or computer keying without the need to access the radio's menu.

The PC board mounts on top of the CH-340 G module by means of mating header connectors, and the combination is nested into a 3D printed enclosure.

<https://www.ebay.com/itm/1PCS-USB-To-TTL-CH340G-Converter-Module-Serial-Port-Nine-Small-Brush-Board/164223637217?ssPageName=STRK%3AMEBIDX%3AIT&trksid=p2057872.m2749.12649>

https://www.amazon.com/Module-Instead-PL2303-CH340G-Upgrade/dp/B07SOJ844F/ref=sr_1_36?dchild=1&keywords=CH340G&qid=1601000771&sr=8-36

A few photos of the completed project are on the following page, and a zipped file of support information, including this document, Express SCH schematic, data sheets, and 3D printable STL files can be found at:

<https://qsl.net/n5ib/>

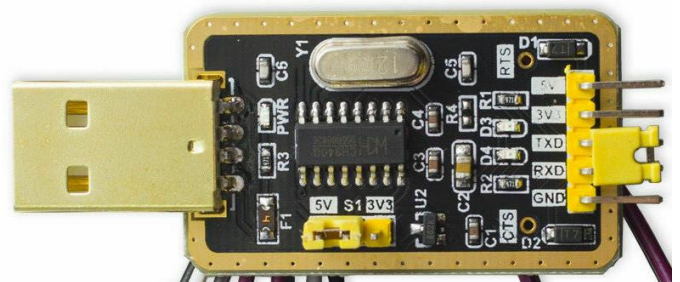
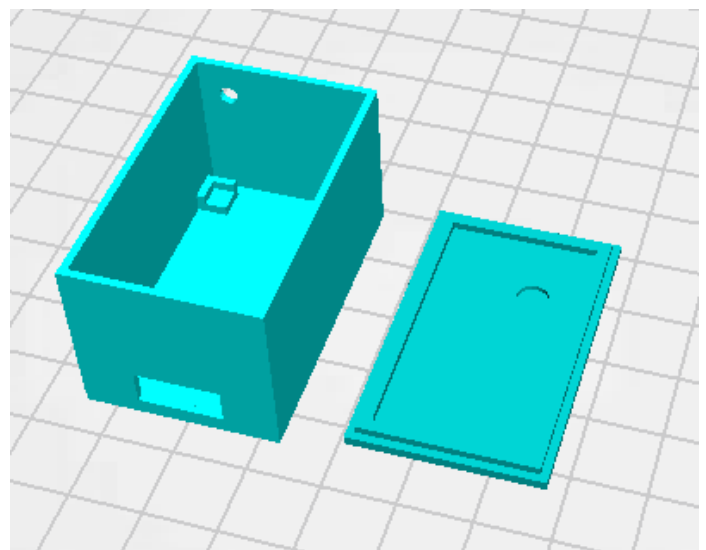
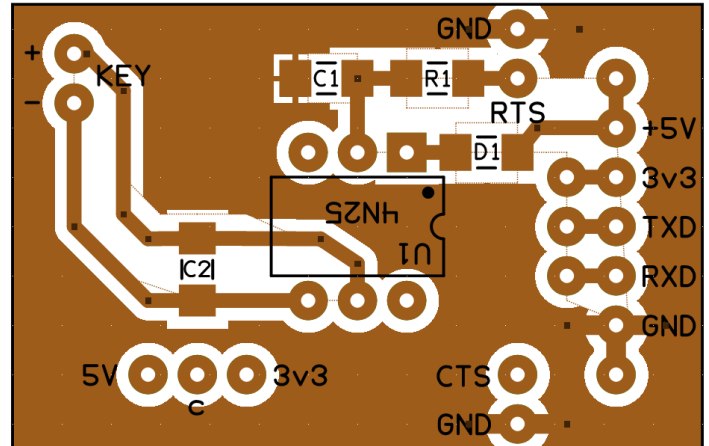
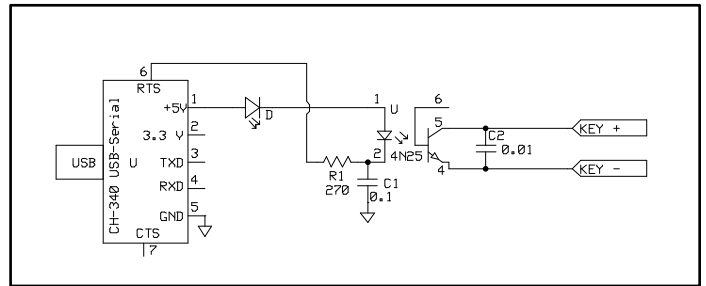

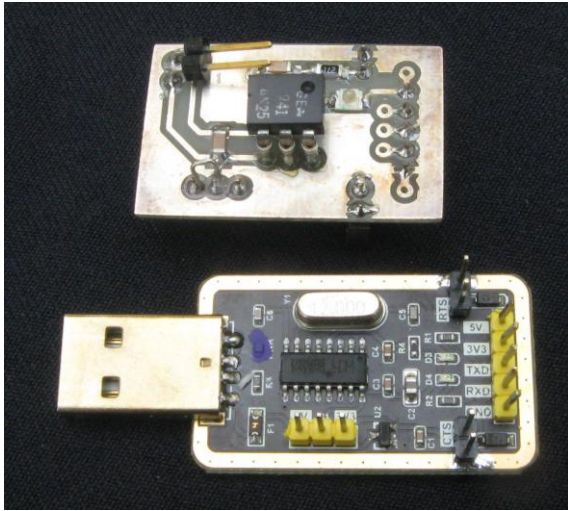

CH340 module and optically coupled interface board.

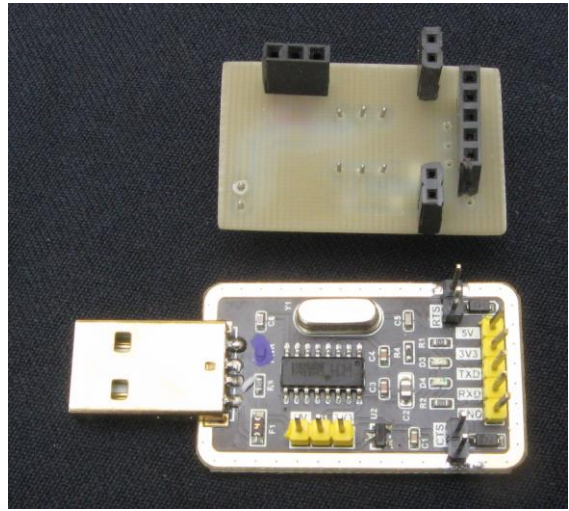

Bottom side of interface board showing header sockets. The header pins on the right side of the CH340 module were factory installed right angled pins. They were bent into a vertical position to mate with the header socket strip on the interface PCB.

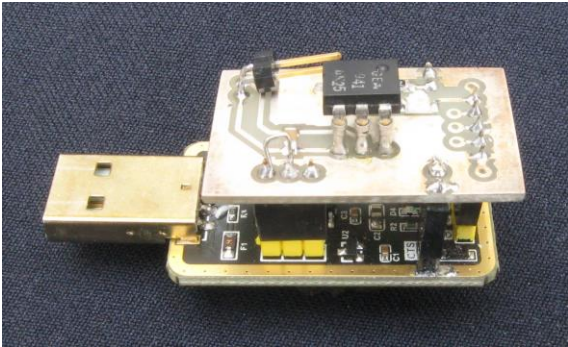

Interface PCB attached to CH340 modules, ready for installation into enclosure.

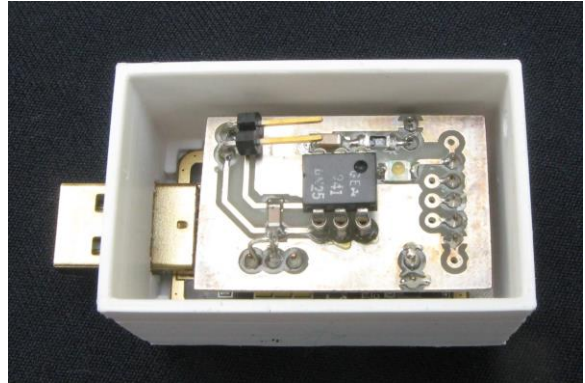

CH340 module and attached interface board installed into 3D printed enclosure.



Completed optically isolated keying interface connected to PC's USB port. The SMD LED keying monitor is visible through a thinned out region of the 3D printed top cover.

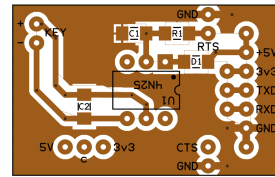

Actual size (0.9" x 1.4" PCB layout.

Materials:

C1 and C2 are 50V size 1206 SMD ceramic capacitors

R1 is a 5% 1206 size SMD resistor

D1 is a 1206 size LED