



Kylie Cooney

PRODUCT DESIGNER

I am a sophomore product design student at  
Otis College of Art and Design.



---

**Project**

George Nelson

---

**Description**

Exploring the modern designs of the iconic designer George Nelson, through studying his work and mimicking his style.

---

**Design Objectives**

To understand the impact of George Nelson on the design world

---

**User**

Modern art and design enthusiasts.

---

**Dimensions**

24" x 48"

---

**Materials**

Matte card stock

---

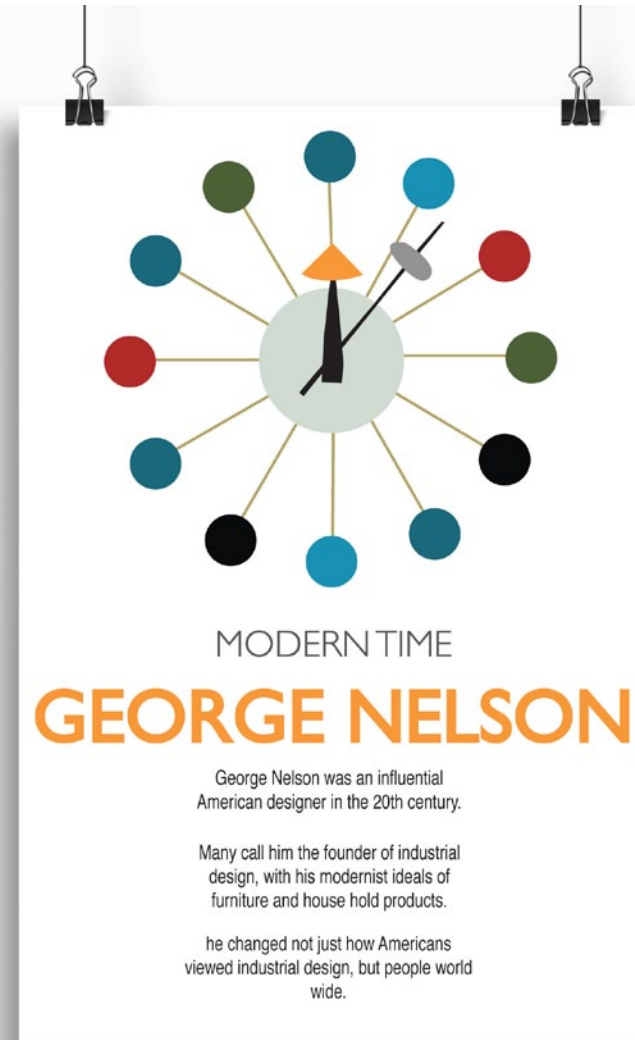

---

George Nelson  
Designer Poster

Modern Times

Kylie Cooney  
Designer  
Kcooney@student.otis.  
edu

“Design is a response to social change”

George Nelson lived from 1908-1986. He was an architect, writer, designer, teacher, author, and a general provocateur.

He was a designer for the Herman Miller furniture company. He was a pivotal role in 20th century designs of furniture, it is iconic in American design.

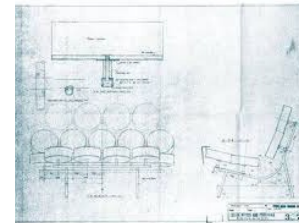

George Nelson

Pioneer in modern furniture

Research

Kylie Cooney  
Product designer  
Kcooney@student.otis.edu



---

**Project**  
Rumpus Rester Dog Bed

---

**Description**  
A handmade, customizable dog bed that changed with the users everyday life.

---

**Design Objectives**  
To design to not just one user, but making it customizable for every user to enjoy it.

---

**User**  
With the customization the user becomes everybody.

---

**Dimensions**  
18 X 10 X 18

---

**Materials**  
Bent Plywood  
Plywood  
Foam  
Wool  
Canvas  
Steel Legs

---

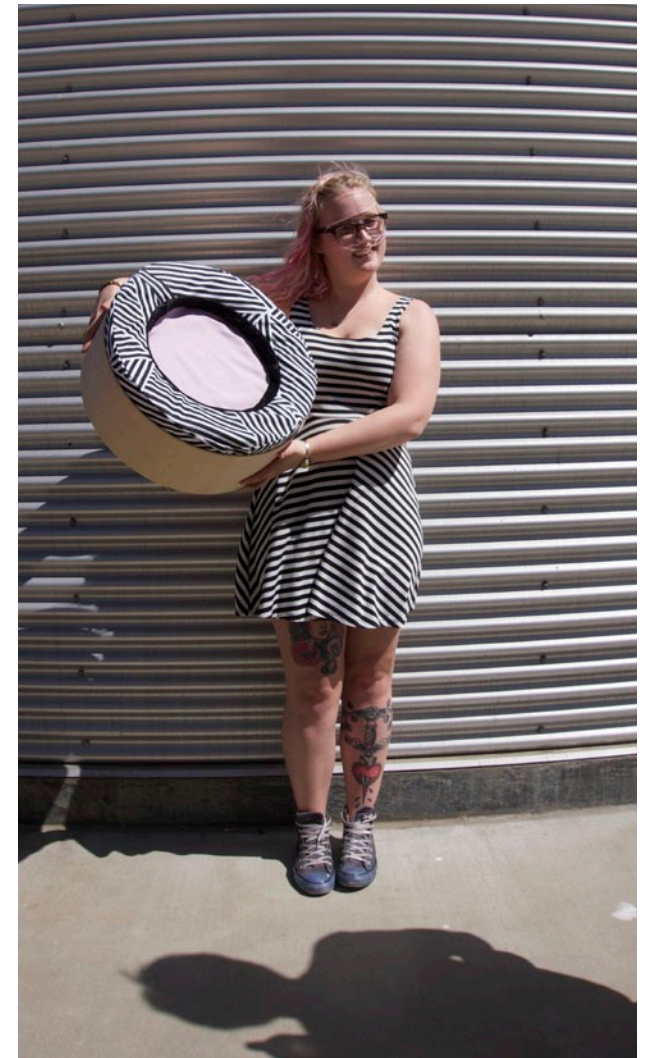

---

Rumpus Rester

The ever changing pet bed

Kylie Cooney  
Product designer  
Kcooney@student.otis.  
edu

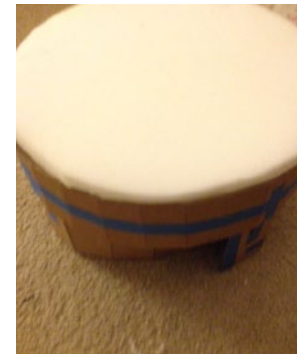

## Material Research

Steel angle iron or steel channel for a base or for support



Soft fabric, in light blue tones to bring out and compliment the orange/yellow tones in the wood



Round thick foam for the inside of the cushion.



The soft cushiony fabric and bed contrast with the harsh steel base, making it look more interesting.



Crafting a wooden bed, similar to these bowls, to put on top of the metal frame and set the cushion in it.

PET LIFESTYLE PROJECT  
EAT, PLAY, LOUNGE

DOGS!

ANALYSIS

\*BASIC QUESTIONS + CLEVER PAK RAT METHOD

- WHAT SIZE DOG? 10-20 LBS. SMALL-MEDIUM
- HOW TALL CAN THE BED BE? 1' AT MOST
- HOW WIDE DOES IT NEED TO BE? 2'
- CAN IT BE MULTIFUNCTIONAL FOR THE DOG + HUMAN? HOLD TOYS?
- WHAT MATERIALS CAN WITHSTAND THE ANIMAL? WOOD, THICK FABRIC

\*SMALL/MEDIUM DOGS

- \*MOST PET STORE BEDS ALL LOOK THE SAME.
- ROUND OR RECTANGLE, CHEAP, FURRY
- \*MOST DONT USE MULTIPLE MATERIALS

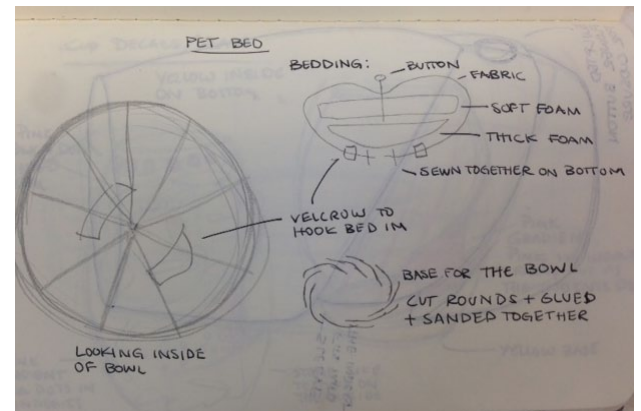
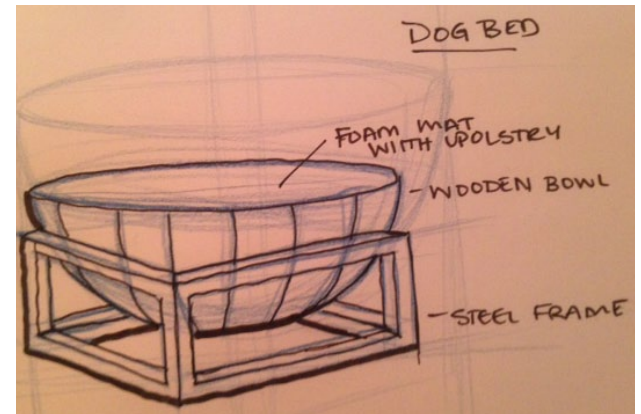

Rumpus Rester

The ever changing pet bed

Ideation

Kylie Cooney  
Product designer  
Kcooney@student.otis.edu

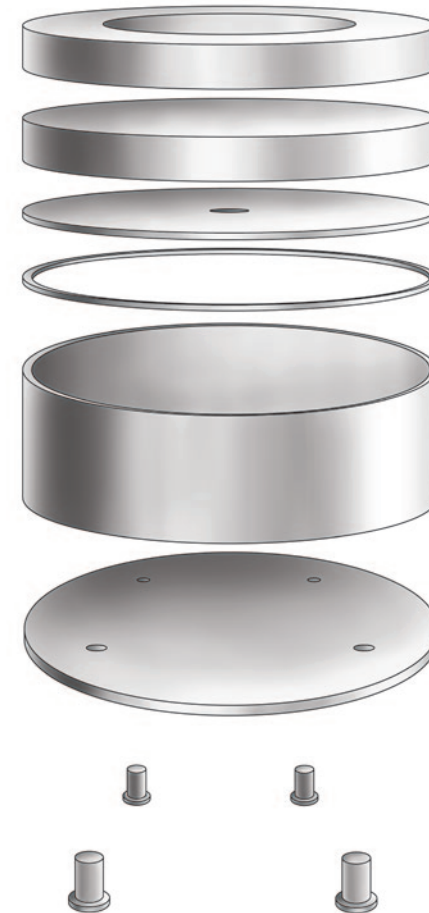
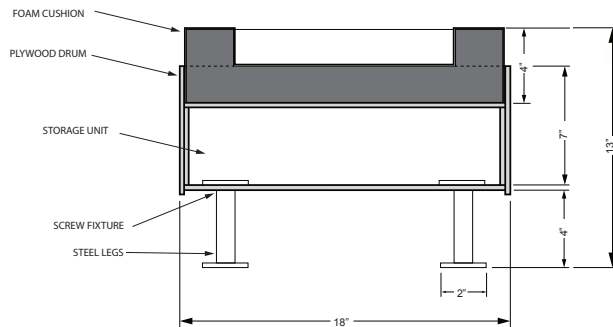
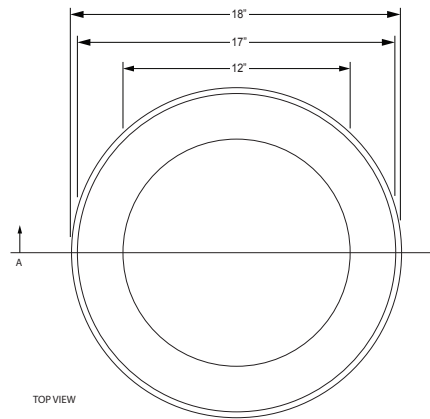
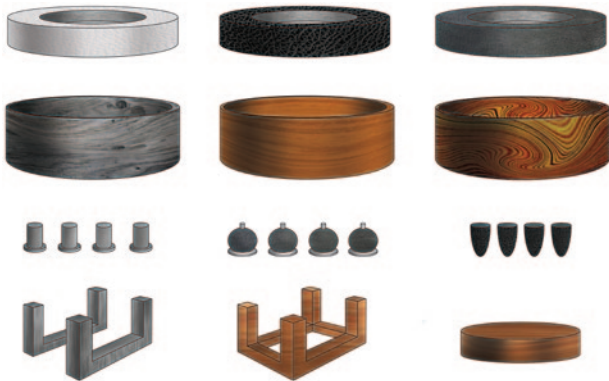

# Rumpus Rester

The ever changing pet bed

Development

Kylie Cooney  
Designer  
Kcooney@student.otis.edu



## Rumpus Rester

The ever changing pet bed

Implement

Kylie Cooney  
Product designer  
Kcooney@student.otis.  
edu



---

**Project**

Crystal Ikebana

---

**Description**

Designing a traditional Japanese ikebana flower vase with a modern twist.

---

**Design Objectives**

To learn to design with a client in mind. To be able to take a classical idea and design and transform it into something new, and modern.

---

**User**

Ikebana flower arrangers at the Huntington Gardens and Library

---

**Dimensions**

12 x 8 x 7

---

**Materials**

Steves white clay  
Glaze



---

## Crystal Ikebana

The solidified growth

Kylie Cooney  
Product designer  
Kcooney@student.otis.  
edu

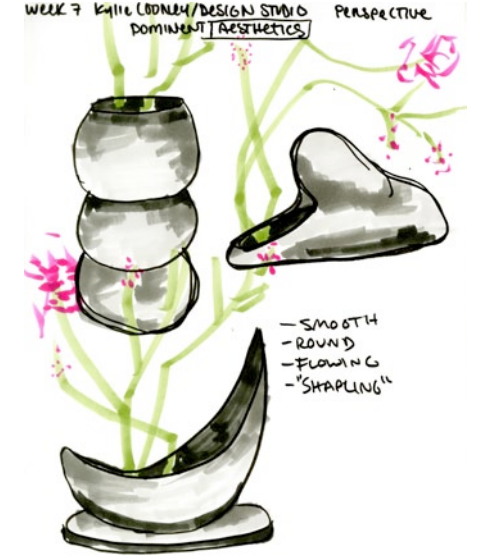
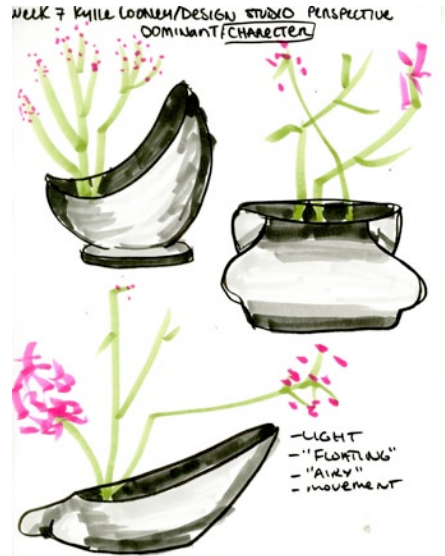
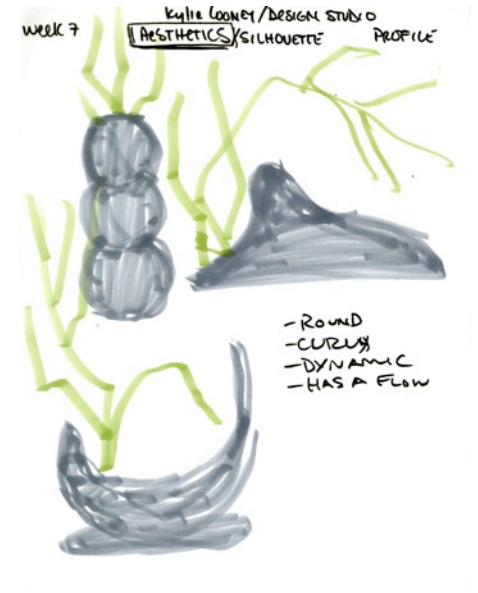
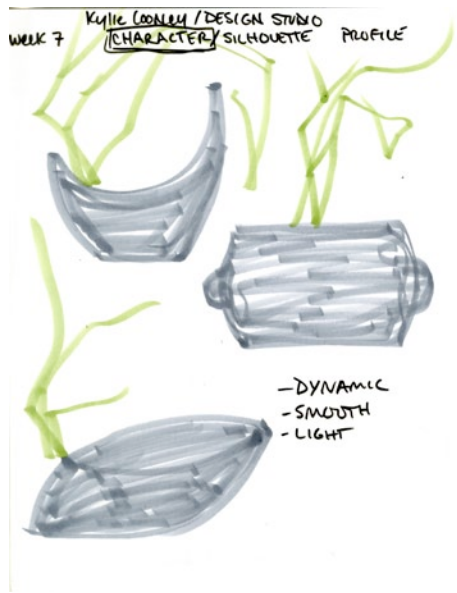

# Crystal Ikebana

The eternal growth

Ideation

Kylie Cooney  
 Product designer  
 Kcooney@student.otis.edu

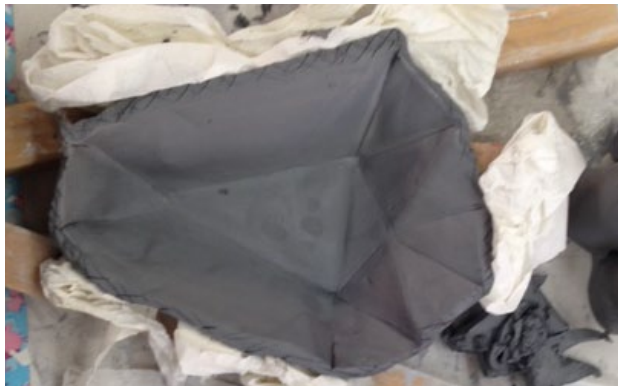
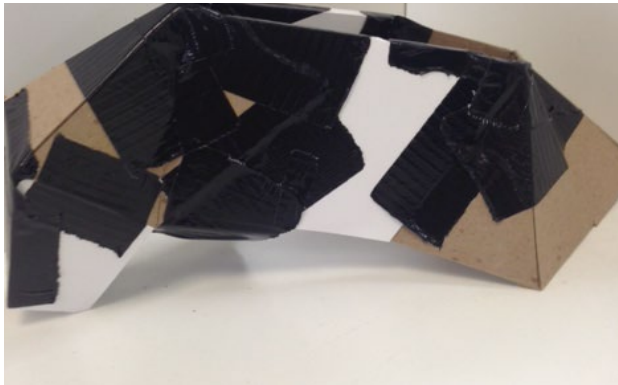
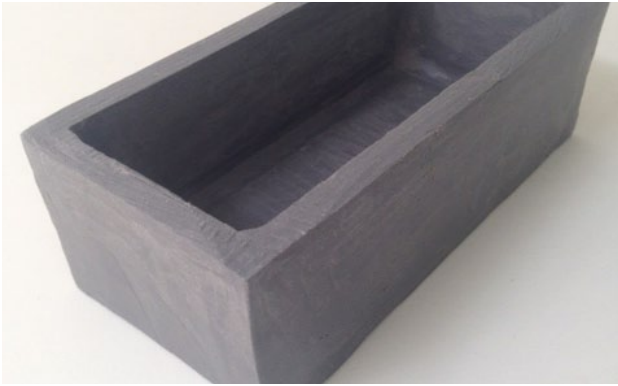

## Crystal Ikebana

The eternal growth

Material Research  
and Development

Kylie Cooney  
Product designer  
Kcooney@student.otis.  
edu



---

**Project**

Infused Nature Shoe

---

**Description**

Creating a life around a stranger that we encounter in public. Then purchasing a product from a thrift store that they would own, and proceeding to design a shoe that they would own, based off of the story and the thrift store object.

---

**Design Objectives**

To integrate creativity into the world of design.  
To use your imagination to make up your client and design to that client.

---

**User**

The stranger that I created a fictional life for.

---

**Dimensions**

6 x 2.5 x 7

---

**Materials**

Sculpy clay  
Gold enamel paint  
Gold guitar screws  
Petg plastic  
Resin epoxy  
Hot glue  
MAC cosmetic pigment



---

All That Glitters

Finding nature in man made

Kylie Cooney  
Product designer  
Kcooney@student.otis.  
edu

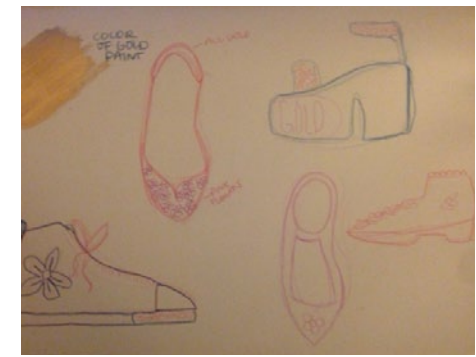

## All That Glitters

Finding nature in man made.

Ideation

Kylie Cooney  
Product designer  
Kcooney@student.otis.edu



## Infused Nature Shoe

Finding nature in man made

Development

Kylie Cooney  
Product designer  
Kcooney@student.otis.  
edu

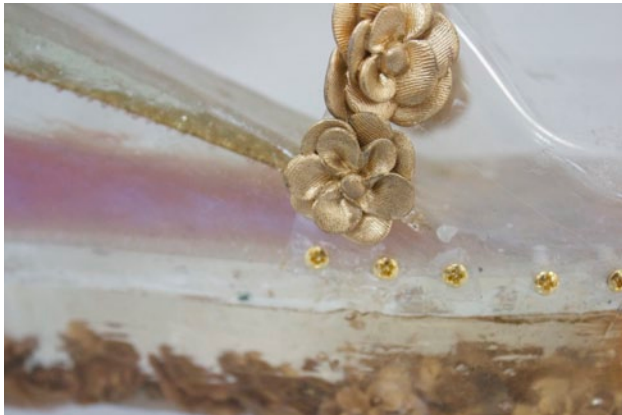

All That Glitters

Finding nature in man made.

Implement

Kylie Cooney  
Designer  
Kcooney@student.otis.  
edu



---

**Project**

Camellia Garden Cup

---

**Description**

Designing a cup, sleeve, and packaging with a partner that correlates to the Camellia Garden at the Huntington Library and Gardens.

---

**Design Objectives**

To design with a client in mind. To learn the process of mass production, to learn how to design with another person, and to learn to package, and design with the full concept in mind.

---

**User**

Visitors shopping at the Huntington Gardens gift shop.

---

**Dimensions**

3.5 x 6 x 3

---

**Materials**

Liquid slip  
Glaze  
Ceramic decals  
Wool  
Bristol Board  
Elastic

---



---

Camellia Garden Cup

Growing through stone, weaving through cultures

Kylie Cooney  
Product designer  
Kcooney@student.otis.  
edu

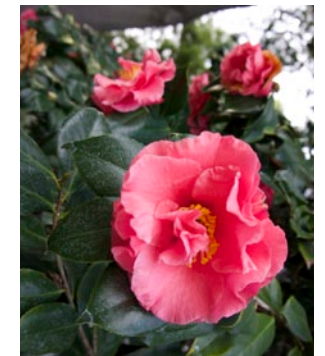
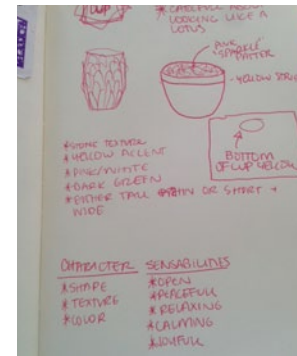
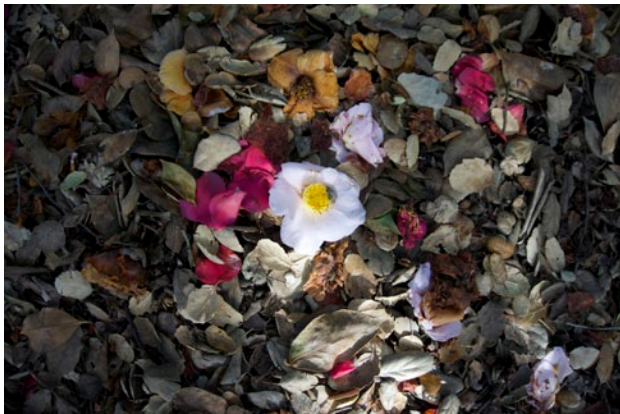
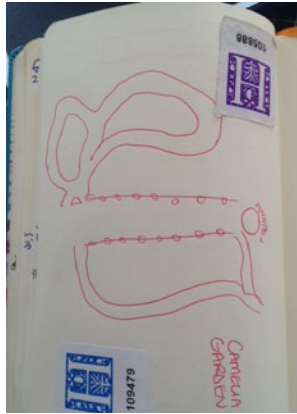

## Camellia Garden Cup

Growing through stone, weaving through cultures

Garden Research

Kylie Cooney  
Product designer  
Kcooney@student.otis.edu

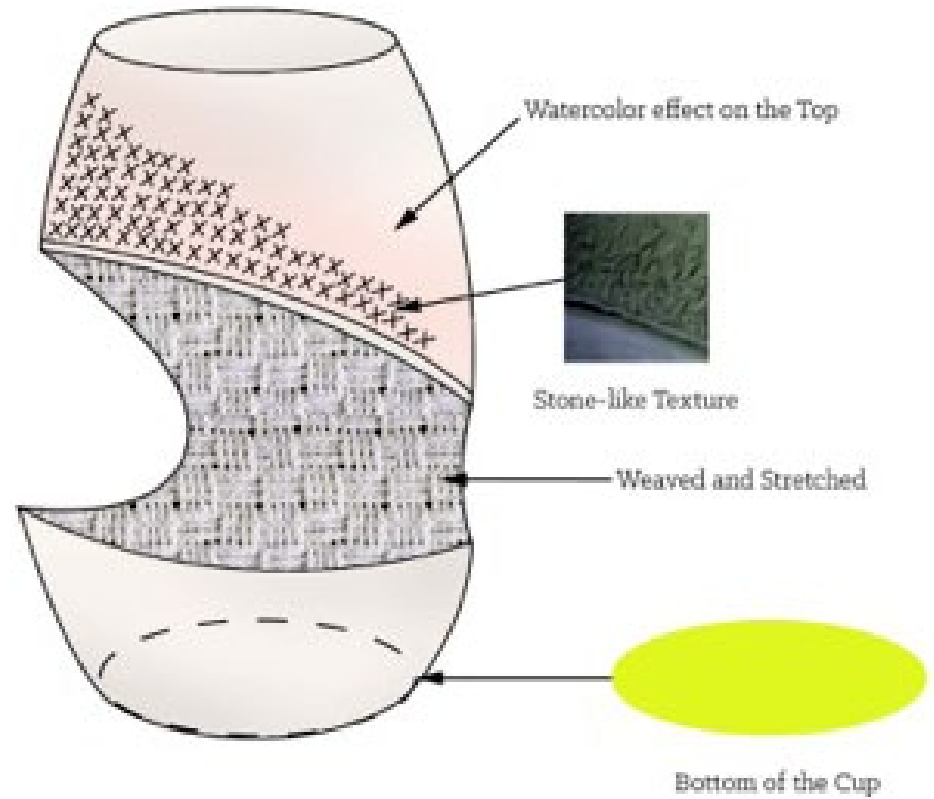
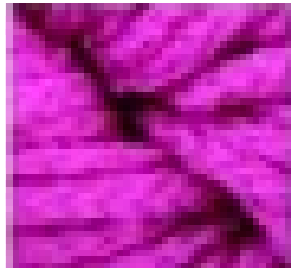
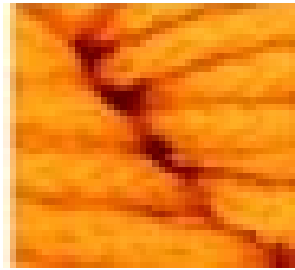
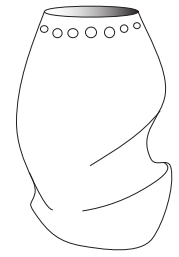
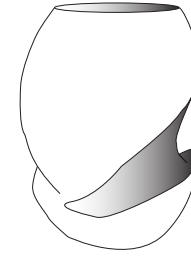
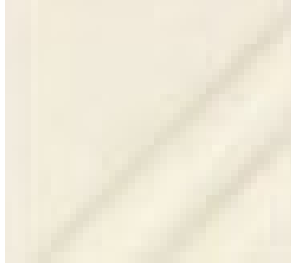

# Camellia Garden Cup

Growing through stone, weaving through cultures

Ideation

Kylie Cooney  
Product designer  
Kcooney@student.otis.edu

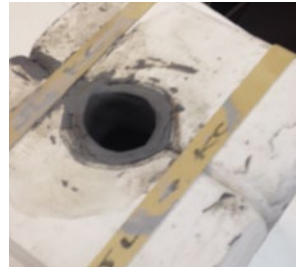
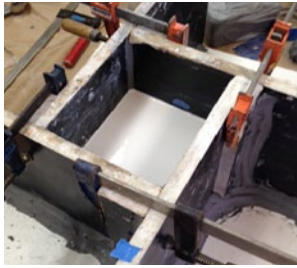

# Camellia Garden Cup

Growing through stone, weaving through cultures

Mold making

Kylie Cooney  
Designer  
Kcooney@student.otis.edu



# Camellia Garden Cup

Growing through stone, weaving through cultures

Implement

Kylie Cooney  
Product designer  
Kcooney@student.otis.edu



---

**Project**

Fresh Ales Brewery

---

**Description**

Designing a brewery and beer based off an area in Los Angeles, Bel Air. Playing off of the older TV show *The Fresh Prince of Bel Air*.

---

**Design Objectives**

Learning to design to something rather than just designing. Increasing abilities in Adobe Photoshop and Adobe Illustrator.

---

**User**

21-39 year old in pursuit of a novelty beer.

---

**Dimensions**

8 x 11

---

**Materials**

Virtual rendering

---



---

Fresh Ales Brewery

The Prince Pale Ale

Kylie Cooney  
Product designer  
Kcooney@student.otis.  
edu



*The*  
**FRESH ALES**  
*of Bel-Air*

ENJOY RESPONSIBLY

**Prince Pale Ale**

16 OZ

8% ALCOHOL

**“GOVERNMENT WARNING: (1) According to the Surgeon General, women should not drink alcoholic beverages during pregnancy because of the risk of birth defects. (2) Consumption of alcoholic beverages impairs your ability to drive a car or operate machinery, and may cause health problems.”**

Fresh Ales Brewery

The Prince Pale Ale

Development

Kylie Cooney  
Product designer  
Kcooney@student.otis.edu



Fresh Ales Brewery

The Prince Pale Ale

Implement

Kylie Cooney  
Designer  
Kcooney@student.otis.  
edu



---

**Project**

Light Project

---

**Description**

Redesigning a lamp to be more interesting, and re creating the classic idea of a lamp.

---

**Design Objectives**

To integrate creativity into the world of design.  
To begin to question basic objects around you,  
and to teach yourself to see design in everything  
around you.

---

**User**

The everyday female, ages 10-100.

---

**Dimensions**

12 x 6 x 6

---

**Materials**

Sculpy clay  
Lamp electrical kit  
Lamp shade  
Lace  
Spray Paint  
Light bulb



---

Baby Faced

Young light

Kylie Cooney  
Product designer  
Kcooney@student.otis.  
edu

## Lights

### Electric powered light source:

- Electron-simulated
  - Cathodoluminescence
  - Cathode ray tube
  - Electron stimulated luminescence
  - Crookes tube
- Incandescent lamps
  - Carbon button lamp
  - Conventional incandescent light bulbs
    - Flashlight
  - Halogen lamps
  - Globar
  - Nerst lamp
- Electroluminescent lamps
  - Light-emitting diodes
    - Organic light-emitting diodes
    - Polymer light-emitting diodes
    - Solid-state lighting
    - LED lamp
    - OLED
    - AMOLED
  - Light-emitting electrochemical cells
  - Electroluminescent sheets
  - Electroluminescent wires
  - Field-induced polymer electroluminescent
- Gas discharge lamp
  - Induction lighting
  - Fluorescent lamp
    - Compact fluorescent lamp
    - Tanning lamp
    - Black lights
    - Geissler tube
    - Moore tube
    - "Ruhmkorrd" lamp
  - hollow-cathode lamp
  - excimer lamp
  - neon and argon lamps
    - dekatron
    - nixie tube
  - plasma lamp
  - xenon flash lamp
- high-intensity discharge lamps
  - carbon arc lamps
  - ceramic discharge metal-halide lamp
  - hydrargyrm medium-arc iodide lamp
  - mercury-vapor lamp
  - metal-halide lamp
  - sodium-vapor lamp
  - sulfur lamp
  - xenon arc lamp

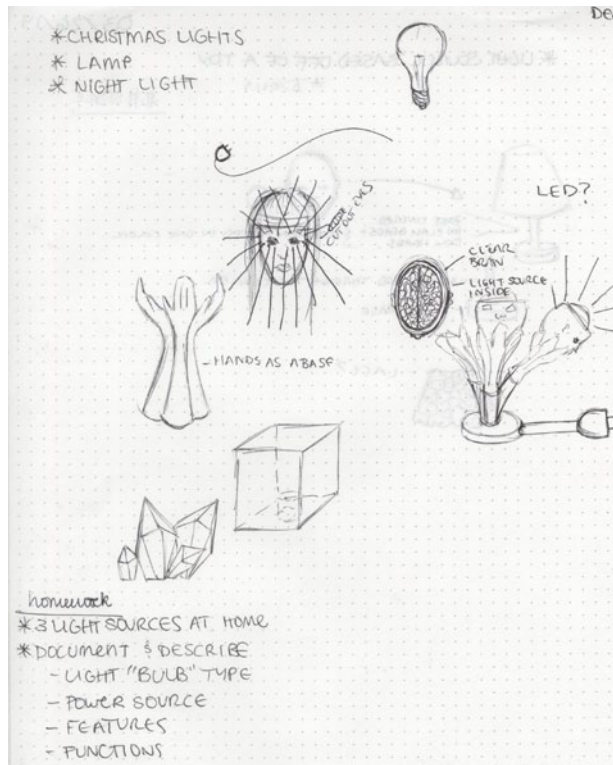
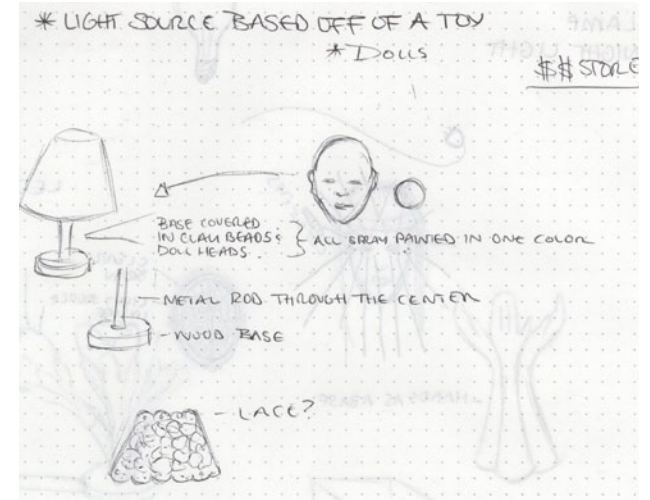

Baby Faced

Research, ideation, and inspiration

Kylie Cooney  
Product designer  
Kcooney@student.otis.edu



Baby Faced

Young light

Implement

Kylie Cooney  
Designer  
Kcooney@student.otis.  
edu



---

**Project**  
Slug Wear

---

**Description**  
A project correlating to food. Designing an item that somehow has to do with the preparing, serving, or eating food.

---

**Design Objectives**  
Recycling old objects to create a new and innovative design. Mixing typical notions of what is grotesque with what is not. Blurring these lines to make the user question their beliefs.

---

**User**  
Everyone, all ages.

---

**Dimensions**  
12 X 3 X 2

---

**Materials**  
Sculpy clay  
Recycled bamboo spoon  
Aluminum tubing  
Gauche  
Acrylic paint



---

Slug Wear

Kylie Cooney  
Product designer  
Kcooney@student.otis.  
edu

SLUGS

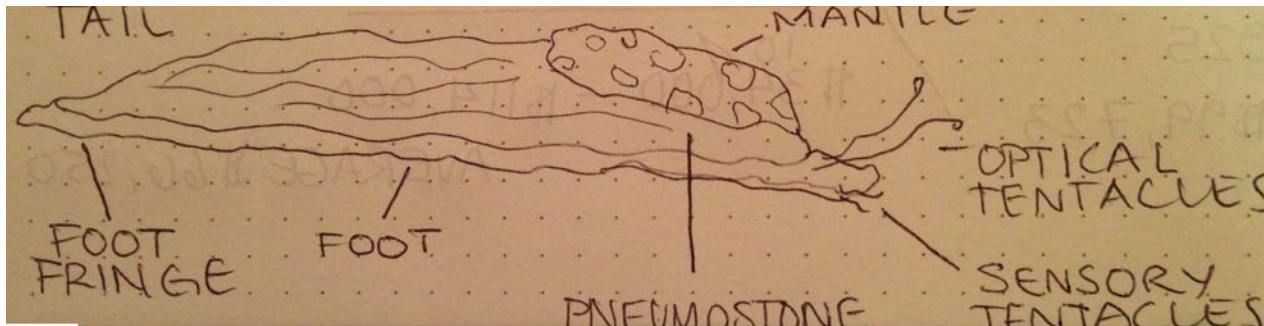

Slug Wear

Ideation

Kylie Cooney  
Product designer  
Kcooney@student.otis.edu

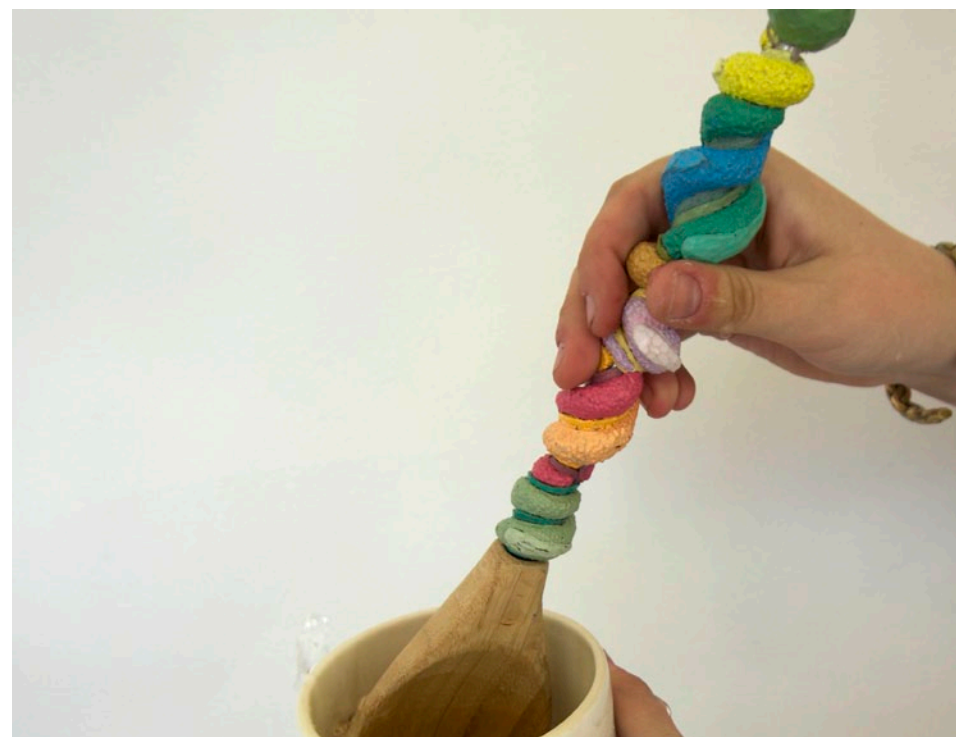

Slug Wear

Implement

Kylie Cooney  
Designer  
Kcooney@student.otis.  
edu



---

**Project**

Air Guitar

---

**Description**

Hybrid Electric Gutar Combining Ideas gushers, madonna, + polaroid camera

---

**Design Objectives**

Extract form, materials, and messaging from Era Specific Research to design “artifacts”—soft good accessories, lighting, etc, to be used in an Air Guitar Performance.

---

**Dimensions**

12 x 3 x 2

---

**Materials**

Sculpy, Spray Paint, Chain, Resin, Wire, Hot Glue, Telephone cord



---

gushing claws + the pick

Hybrid Electric Gutar Combining Ideas Anarchy,  
Animal rights + TV education  
Music: Call Me - Blondie  
Era: 1980

Kylie Cooney  
product designer  
kcooney@student.otis.

Call Me:  
Blondie (1980)

Color me your color, baby  
Color me your car  
Color me your color, darling  
I know who you are  
Come up off your color chart  
I know where you're comin' from

Call me (call me) on the line  
Call me, call me any, anytime  
Call me (call me) my love  
You can call me any day or night  
Call me

Cover me with kisses, baby  
Cover me with love  
Roll me in designer sheets  
I'll never get enough  
Emotions come, I don't know why  
Cover up love's alibi

Call me (call me) on the line  
Call me, call me any, anytime  
Call me (call me) oh love  
When you're ready we can share the wine  
Call me

Oh, oh, oh, oh, oh, he speaks the languages of love  
Oh, oh, oh, oh, oh, amore, chiamami, chiamami  
Oh, oh, oh, oh, oh, appelle-moi mon cherie, appelle-moi  
Anytime, anyplace, anywhere, any way  
Anytime, anyplace, anywhere, any day-ay

Call me (call me) my love

Call me, call me any, anytime  
Call me (call me) for a ride  
Call me, call me for some overtime  
Call me (call me) my love  
Call me, call me in a sweet design  
Call me (call me), call me for your lover's lover's alibi  
Call me (call me) on the line  
Call me, call me any, anytime  
Call me (call me)  
Oh, call me, oh, oh, ah  
Call me (call me) my love  
Call me, call me any, anytime



gushing claws + the pick

Music as emotional pathway and social change  
agent: Music: Call Me - Blondie  
Era: 1980

Un-packing the  
song

Kylie Cooney  
product designer  
kcooney@student.otis.  
edu

# 1980

## FASHION



POLITICS

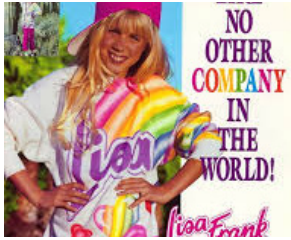

TV



CARS

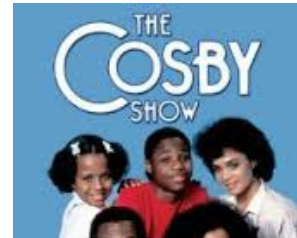

gushing claws + the pick

Music as emotional pathway and social change  
agent: Music: Call Me - Blondie  
Era: 1980

research

Kylie Cooney  
product designer  
kcooney@student.otis.edu

# 1980

## ELECTRONIC



## HAIR



## MUSIC

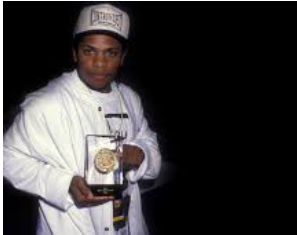

## DESIGN

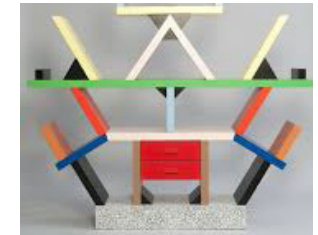
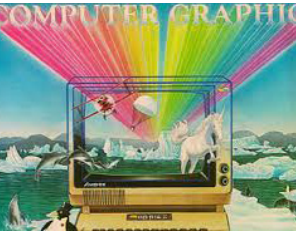

gushing claws + the pick

Music as emotional pathway and social change  
agent: Music: Call Me - Blondie  
Era: 1980

research

Kylie Cooney  
product designer  
kcooney@student.otis.edu

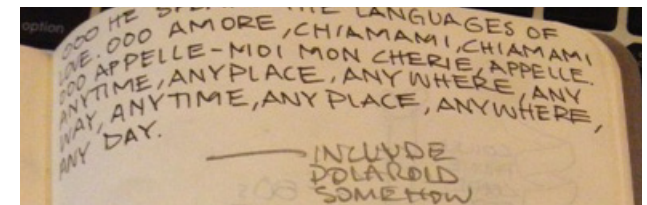
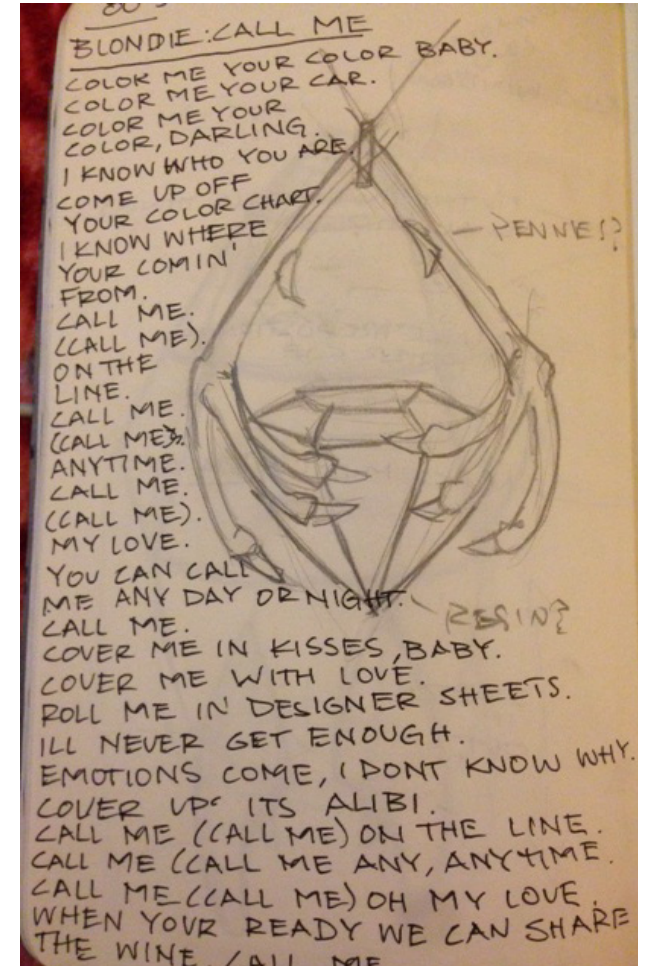
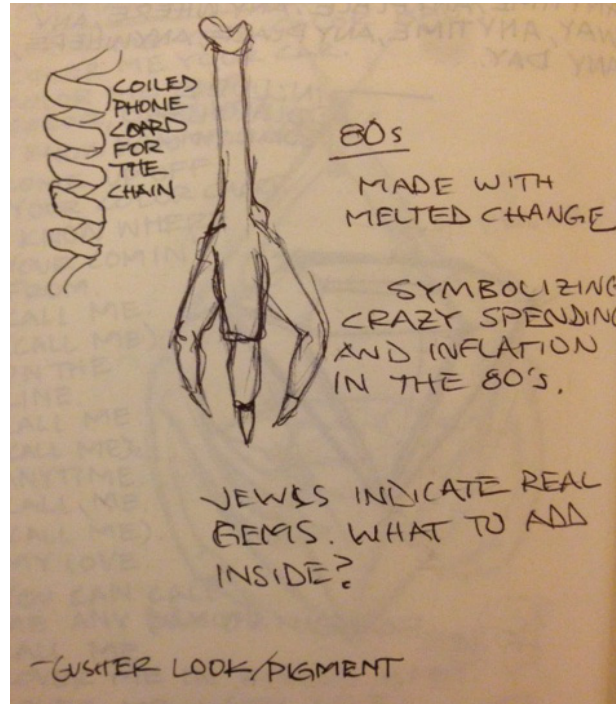
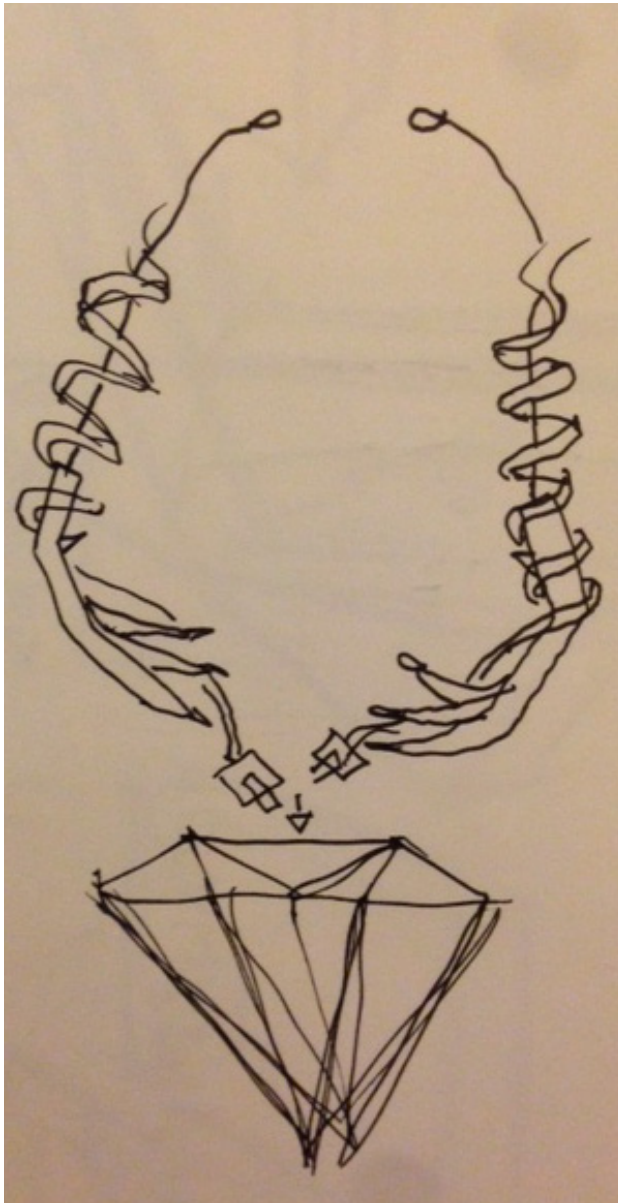

## gushing claws + the pick

Music as emotional pathway and social change agent: Music: Call Me - Blondie  
Era: 1980

ideation

Kylie Cooney  
product designer  
kcooney@student.otis.edu

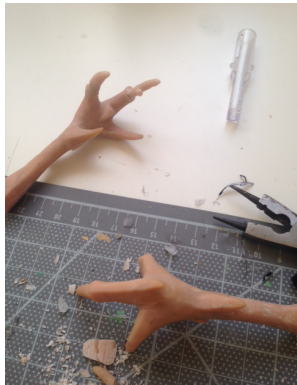

## gushing claws + the pick

Music as emotional pathway and social change  
agent: Music: Call Me - Blondie  
Era: 1980

development

Kylie Cooney  
product designer  
kcooney@student.otis.  
edu

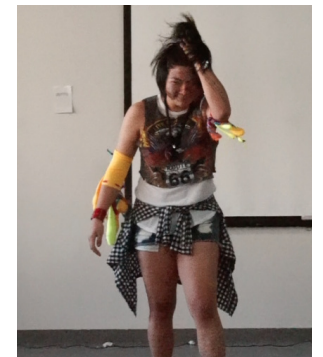
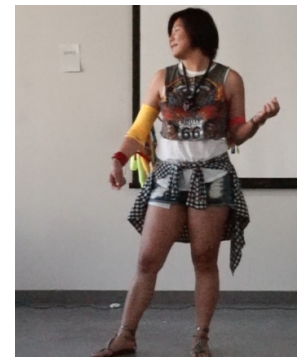
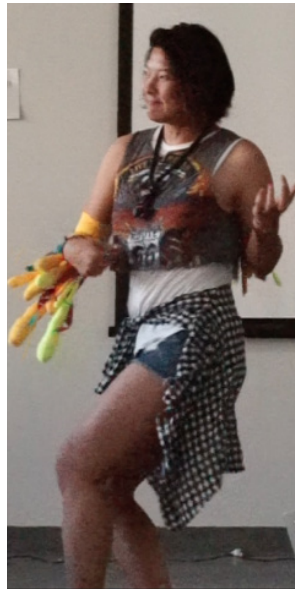
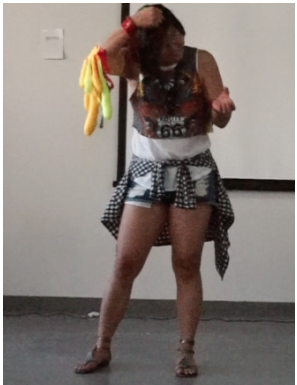
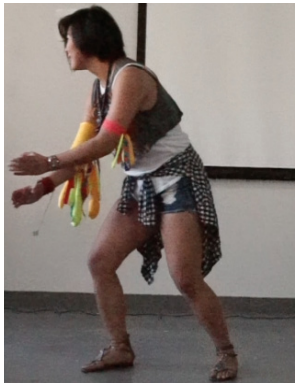

## Gushing claws + the pick

Music as emotional pathway and social change  
agent: Music: Call Me - Blondie  
Era: 1980

performance  
documentation

Kylie Cooney  
product designer  
kcooney@student.otis.  
edu