

## 1 Cold Water Connect

- Find the cold water supply under sink
- Turn the **main valve (angle stop)** off
- Remove the cold water line from the **main valve** by using a wrench

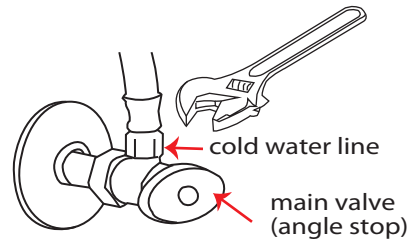

- Totally disconnect the **cold water line**

- Add Teflon tape to the male threads on both the **cold water connect** and **main valve**
- Connect the **cold water connect** to the **main valve**
- Then connect the cold water line to the **cold water connect**
- Tighten both with a wrench

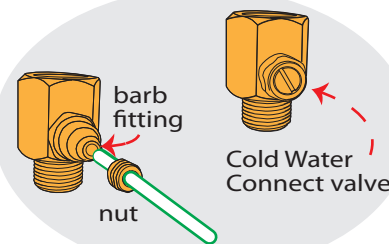
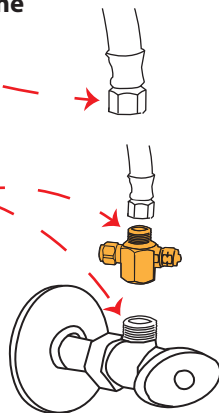

\*Use a flat head screw driver to turn on the **Cold Water Connect**

- Remove the small nut from the **cold water connect**
- Slide the tubing through it
- Connect the 1/4" tubing on to the barb fitting on the **cold water connect**
- Tighten the nut back on with a wrench

## 2

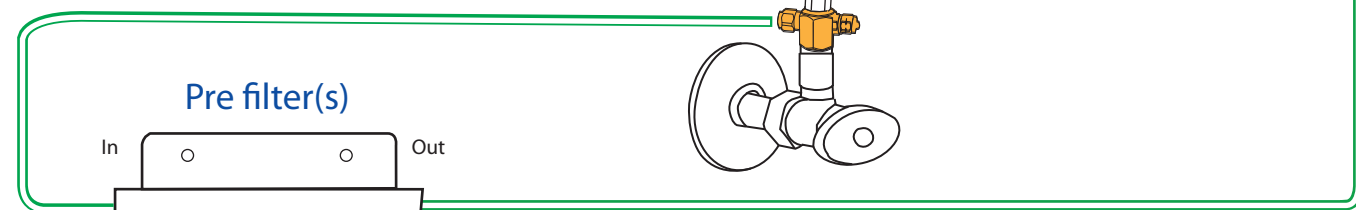

(Flush out pre filters)

**NOTE:**  
Run 2-3 gallons of water through the pre-filters before you connect them to the ionizer.

- Run the other end of the 1/4" tubing that you attached to the **cold water connect** to the (IN) on the **Pre filter**.
- Attach another piece of 1/4" tubing to the (OUT) on the **Pre filter** and connect it to the **Sink Hole Cover Union**.

## 4

Bottom

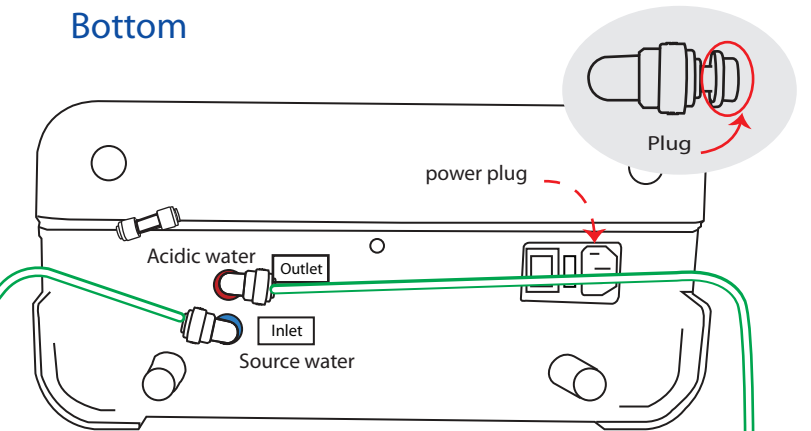

(See page 18 in the manual for **Quick Connect Fitting instructions**).

- After removing the plugs from the inlet and outlet elbows, connect the 1/4" tubing coming from the top of the **sink hole cover**
- Insert another piece of 1/4" tubing in the Acidic water "outlet" and run the other end into the sink securing it with the suction cup provided.
- Connect the power cable to a dedicated outlet.

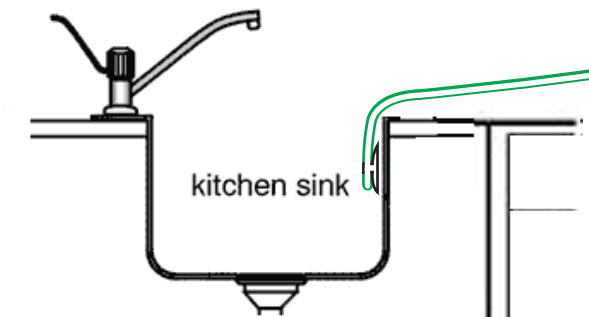

## 5

- Screw the **flexible hose** into the turret until they butt up flush. This should only be hand tightened.\*

\* No Teflon or tools are needed

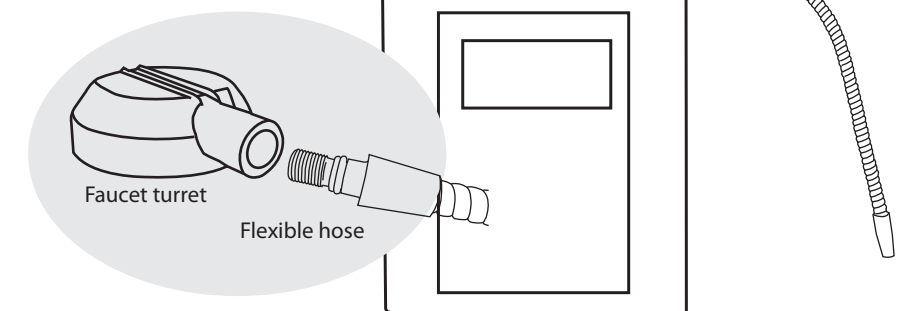

**Last Step:** Turn on the **main valve (angle stop)** and check for leaks.