

UNITED STATES PATENT AND TRADEMARK OFFICE

BEFORE THE PATENT TRIAL AND APPEAL BOARD

APPLE INC., SNAP INC., FACEBOOK, INC.,
and WHATSAPP, INC.,¹
Petitioner,

v.

UNILOC LUXEMBOURG S.A.,²
Patent Owner.

Case IPR2017-00225
Patent 8,995,433 B2

Before JENNIFER S. BISK, MIRIAM L. QUINN, and
CHARLES J. BOUDREAU, *Administrative Patent Judges*.

QUINN, *Administrative Patent Judge*.

FINAL WRITTEN DECISION
35 U.S.C. § 318(a) and 37 C.F.R. § 42.73

¹ Snap Inc. filed a petition and motion for joinder in IPR2017-01611, which we granted. Paper 12. Facebook, Inc. and WhatsApp, Inc., filed a petition and motion for joinder in IPR2017-01634, which we granted. Paper 13. Thus, these entities, as captioned, are joined, as Petitioner, to this proceeding.

² An updated Mandatory Notice filed by Patent Owner pursuant to 37 C.F.R. § 42.8(a)(2) states that Uniloc Luxembourg S.A. is the Patent Owner. Paper 25.

I. INTRODUCTION

In this *inter partes* review, instituted pursuant to 35 U.S.C. § 314, Petitioner, as listed in the caption above, challenges the patentability of claims 1–6 and 8 of U.S. Patent No. 8,995,433 B2 (Ex. 1001, “the ’433 patent”), owned by Uniloc Luxembourg S.A. We have jurisdiction under 35 U.S.C. § 6(c). This Final Written Decision is entered pursuant to 35 U.S.C. § 318(a) and 37 C.F.R. § 42.73. For the reasons discussed below, Petitioner has not shown by a preponderance of the evidence that claims 1–6 and 8 (“the challenged claims”) of the ’433 patent are unpatentable.

A. PROCEDURAL HISTORY

Apple Inc. filed a Petition to institute *inter partes* review of claims 1–6 and 8 of the ’433 patent. Paper 2 (“Pet.”). Patent Owner filed a Preliminary Response. Paper 6 (“Prelim. Resp.”). On May 25, 2017, we instituted *inter partes* review as to all challenged claims. Paper 7 (“Institution Decision” or “Dec”). Snap Inc., Facebook, Inc., and WhatsApp, Inc. are joined to this proceeding pursuant to our grant of petitions and motions for joinder filed in IPR2017-01611 and IPR2017-01634. Papers 12, 13.

After institution, Patent Owner filed a Patent Owner Response. Paper 11 (“PO Resp.”). And Petitioner filed a Reply. Paper 15 (“Reply”). We heard oral arguments on February 8, 2018. A transcript of the hearing has been entered into the record. Paper 26 (“Tr.”).

B. RELATED MATTERS

The parties indicate that the ’433 patent is involved in *Uniloc USA, Inc. v. Apple, Inc.*, Case No. 6-16-cv-00638 (E.D. Tex.), *Uniloc USA, Inc. v.*

IPR2017-00225
Patent 8,995,433 B2

Snap Inc., 2-16-cv-00696-JRG (E.D. Tex.), *Uniloc USA, Inc. v. Facebook, Inc.*, 2-16-cv-00728-JRG (E.D. Tex.), *Uniloc USA, Inc. v. WhatsApp, Inc.*, 2-16-cv-00645-JRG (E.D. Tex.), and other proceedings. Pet. 75–77; Paper 28.

The '433 patent also has been the subject of multiple petitions for *inter partes* review filed by various petitioners. Paper 28 at 3. We mention here that the '433 patent is also the subject matter of IPR2017-01427 and IPR2017-01428, filed by two Petitioner entities in this proceeding: Facebook, Inc., and WhatsApp, Inc.

C. REAL PARTIES-IN-INTEREST

Patent Owner asserts that Uniloc U.S.A., Inc. is the exclusive licensee and is a real party-in-interest. Paper 25.

D. THE '433 PATENT (EX. 1001)

The '433 patent relates to Internet telephony, and more particularly, to instant Voice over IP (“VoIP”) messaging over an IP network, such as the Internet. Ex. 1001, 1:19–23. The '433 patent acknowledges that “[i]nstant text messaging is [] known” in the VoIP and public switched telephone network (“PSTN”) environments, with its server presenting the user with a “list of persons who are currently ‘online’ and ready to receive text messages on their own client terminals.” *Id.* at 2:35–42. In one embodiment, such as depicted in Figure 2 (reproduced below), the system of the '433 patent involves an instant voice message (IVM) server and IVM clients. *Id.* at 7:21–22.

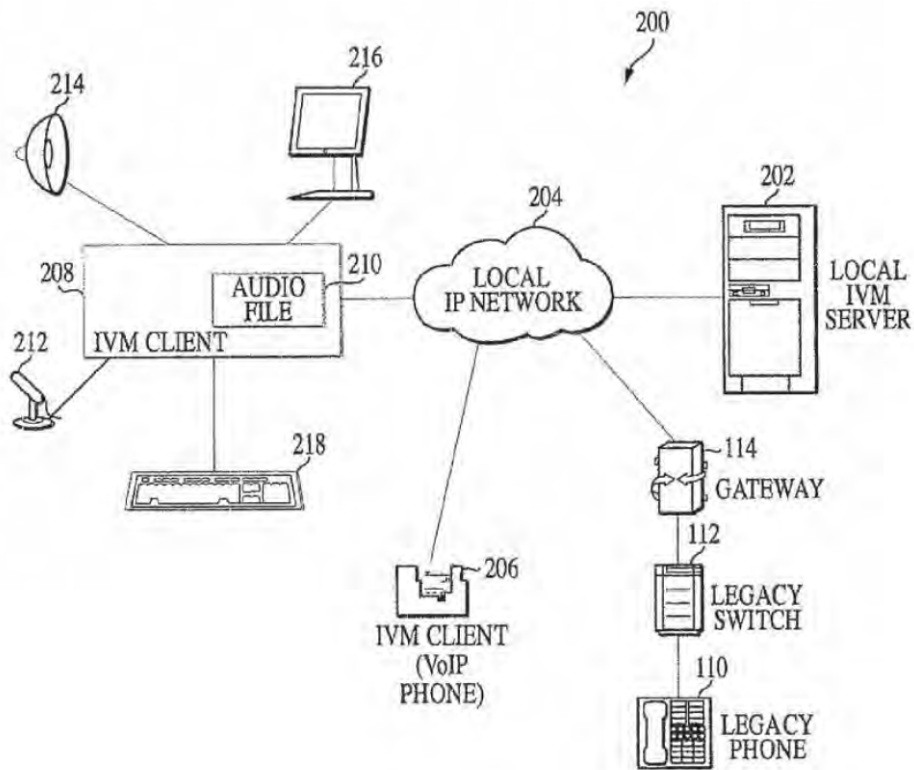

FIG. 2

Figure 2 illustrates IVM clients 206, 208 and legacy telephone 110 interconnected via network 204 to the local IVM server 202, where IVM client 206 is a VoIP telephone, and where legacy telephone 110 is connected to legacy switch 112 and further to media gateway 114. *Id.* at 6:65–7:6, 7:27–49. The media gateway converts the PSTN audio signal to packets for transmission over a packet-switched IP network, such as local network 204. *Id.* at 7:49–53. In one embodiment, when in “record mode,” the user of an IVM client selects one or more IVM recipients from a list. *Id.* at 8:2–5. The IVM client listens to the input audio device and records the user’s speech into a digitized audio file at the IVM client. *Id.* at 8:12–15. “Once the recording of the user’s speech is finalized, IVM client 208 generates a send signal indicating that the digitized audio file 210 (instant voice message) is

ready to be sent to the selected recipients.” *Id.* at 8:19–22. The IVM client transmits the digitized audio file to the local IVM server, which, thereafter, delivers that transmitted instant voice message to the selected recipients via the local IP network. *Id.* at 8:25–26. Only the available IVM recipients, currently connected to the IVM server, will receive the instant voice message. *Id.* at 8:36–38. If a recipient “is not currently connected to the local IVM server 202,” the IVM server temporarily saves the instant voice message and delivers it to the IVM client when the IVM client connects to the local IVM server (i.e., is available). *Id.* at 8:38–43.

The ’433 patent also describes an “intercom mode” of voice messaging. *Id.* at 11:34–37. The specification states that the “intercom mode” represents real-time instant voice messaging. *Id.* at 11:37–38. In this mode, instead of creating an audio file, one or more buffers of a predetermined size are generated in the IVM clients or local IVM servers. *Id.* at 11:38–41.

Successive portions of the instant voice message are written to the one or more buffers. *Id.* at 11:41–46. As the buffers fill, the content of each buffer is automatically transmitted to the IVM server for transmission to the one or more IVM recipients. *Id.* Buffering is repeated until the entire instant voice message has been transmitted to the IVM server. *Id.* at 11:46–59.

E. REPRESENTATIVE CLAIM

Of the challenged claims, claims 1 and 6 are independent. Each of claims 2–5 and 8 depends directly or indirectly from claim 1. Claim 1 is representative:

1. A system comprising:

an instant voice messaging application including a client platform system for generating an instant voice message and a messaging system for transmitting the instant voice message over a packet-switched network via a network interface;

wherein the instant voice messaging application displays a list of one or more potential recipients for the instant voice message;

wherein the instant voice messaging application includes a message database storing the instant voice message, wherein the instant voice message is represented by a database record including a unique identifier; and

wherein the instant voice messaging application includes a file manager system performing at least one of storing, deleting and retrieving the instant voice messages from the message database in response to a user request.

Ex. 1001, 23:65–24:15.

F. INSTITUTED GROUNDS OF UNPATENTABILITY

We instituted *inter partes* review based on the following prior art (Dec. 26–27):

- a) *Abhuri*: U.S. Patent Appl. Pub. No. US 2003/0147512 A1, published Aug. 7, 2003, filed in the record as Exhibit 1005;
- b) *Holtzberg*: U.S. Patent No. 6,625,261 B2, issued Sept. 23, 2003, filed in the record as Exhibit 1007;
- c) *Vuori*: U.S. Patent Appl. Pub. No. US 2002/0146097 A1, published Oct. 10, 2002, filed in the record as Exhibit 1009;

- d) *Logan*: U.S. Patent No. 5,732,216, issued Mar. 24, 1998, filed in the record as Exhibit 1008; and
- e) *Väänänen*: U.S. Patent No. 7,218,919 B2, issued May 15, 2007, filed in the record as Exhibit 1006.

The trial involves the following obviousness grounds:

Challenged Claim(s)	Reference(s)
1, 2, 4, and 8	Abburi and Holtzberg
3	Abburi, Holtzberg, and Vuori
5 and 6	Abburi, Holtzberg, and Logan
1, 2, 4–6, and 8	Väänänen and Holtzberg
3	Väänänen, Holtzberg, and Vuori

In addition to the supporting argument for these grounds in the Petition, Petitioner also presents expert testimony. Ex. 1003, Declaration of Leonard J. Forsy, Ph.D. (“First Forsy Declaration”); Ex. 1019, Supplemental Declaration of Leonard J. Forsy, Ph.D (“Reply Forsy Declaration”). Patent Owner supports its arguments of patentability with a Declaration of William Easttom II. Ex. 2001 (“Easttom Declaration”).

II. ANALYSIS

A. CLAIM INTERPRETATION

The Board interprets claims using the “broadest reasonable construction in light of the specification of the patent in which [they] appear[.]” 37 C.F.R. § 42.100(b). We presume a claim term carries its plain meaning, which is the meaning customarily used by those of skill in the relevant art at the time of the invention. *Trivascular, Inc. v. Samuels*, 812 F.3d 1056, 1062 (Fed. Cir. 2016).

In our Decision on Institution, we did not construe expressly any term. Dec. 7. During trial, Patent Owner argues for construction of the term “instant voice messaging application,” recited in claims 1 and 6. PO Resp. 8–9. In particular, Patent Owner proposes that the plain reading of the claim language yields an application that is located at the client. *Id.* at 9. Petitioner responds that the application is not restricted to a single device, among other arguments. Reply 3. The argument is not only directed to the location of the “instant voice messaging application.” Rather, the dispute arises because claim 1 recites a message database as follows: “the instant voice messaging application includes a message database.” *See, e.g.*, PO Resp. 10 (Patent Owner arguing that the “message database” is at the originating client); Reply 3–5 (Petitioner promoting a distributed application view of the invention to argue that the message database is not restricted to either a single device or the client).

First, we address whether the “instant voice messaging application” is restricted to any particular location. Then we address the “message database.”

1. Instant voice messaging application

Both challenged independent claims recite this term. Following the plain language, both claims require that the “instant voice messaging application”:

- i. Include a “client platform system for generating an instant voice message”;
- ii. Include a “messaging system” for transmitting the instant voice message over a packet-switched network via a network interface;

- iii. Display a “list of one or more potential recipients for the instant voice message”; and
- iv. Include a “file manager system.”

With regard to the “message database,” claim 1 requires that the “instant voice messaging application” include a message database storing the instant voice message. But claim 6 does not include the same limitation. Instead, claim 6 recites the “message database” only in connection with the storing, deleting, and retrieving functions of the “file manager system.”

Thus, from the plain language of these claims, we understand claim 1 to require expressly that the message database is included in the “instant voice messaging application,” while claim 6 does not recite this inclusion explicitly. A further point of distinction between the independent claims is claim 6’s language that the “instant voice messaging application” includes “a compression/decompression system for compressing the instant voice messages to be transmitted over the packet-switched network and decompressing the instant voice messages received over the packet-switched network.” Claim 1 omits this limitation. Therefore, claims 1 and 6 are not identical in scope, but have substantial overlap in what constitutes an “instant voice messaging application.”

From our review of the claim language alone, it is reasonable to conclude that all of the recited functions of the components of the “instant voice messaging application” appear to be performed at a client of the recited system (as opposed to a server or other network component). *See* Dec. 18 (noting at institution that under a plain reading of the claim language the “instant voice messaging application” is directed to the application at the client). To start with, the client platform system, the

messaging system, the displayed list, and the compression/decompression system all are involved in generating and transmitting the instant voice message, whereas the “message database” and the “file manager system” are involved post-transmission of the instant voice message, i.e., storing, deleting, and retrieving instant voice messages. Thus, although the *client* platform system is the only component expressly assigned to the client, the functions of the remaining components logically are included, at a minimum, where the instant voice messages are generated, transmitted, and managed in storage, namely, at the client. Without an express claim requirement of the application’s location, however, we look to the Specification to give context to our understanding of the claim language with regard to the location and operation of the “instant voice messaging application.”

We begin with recognizing that the Specification neither defines nor provides examples of the “instant voice messaging application.” The Specification provides two relevant embodiments, depicted in Figures 3 and 4.

In connection with the first of the embodiments, Figure 3 (reproduced below) and its corresponding description describe IVM client 208, its components, and its relationship to IP network 204 and local IVM server 202.

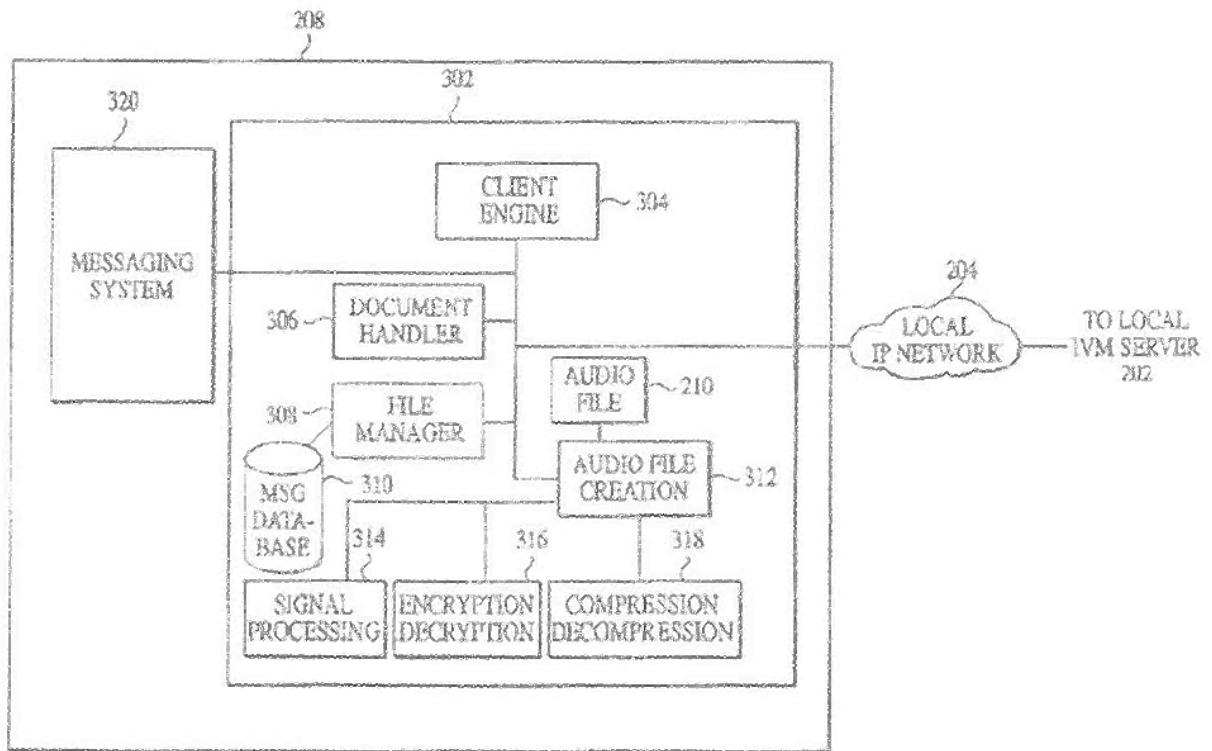

FIG. 3

Figure 3 depicts an example of the architecture in IVM client 208 for enabling instant voice messaging. Ex. 1001, 6:30–31; 12:6–8. The recited components of the “instant voice messaging application” are all included within the depicted IVM client 208: client platform 302 (for generating an instant voice message); messaging system 230 (for messaging between IVM client 208 and IVM server 202); file manager 308 (which services requests from the user to record, delete or retrieve messages to/from message database 310); compression/decompression 318 (for compressing/decompressing the outgoing/incoming audio files). *Id.* at 12:8–52. With regard to this embodiment, the Specification also describes IVM client 208 as a “general-purpose programmable computer.” *Id.* at 12:13–14. Thus, a person of ordinary skill in the art, according to the expert

testimony of record, would conclude that the “instant voice messaging application” is, at a minimum, a program operating at the general-purpose programmable computer of the IVM client depicted in Figure 3, where the functions of the program align with the recited components. *See* Ex. 1003 ¶ 94 (Dr. Forys stating that an “application” is a “set of coded instructions that enable a machine (e.g., a computer) to perform a sequence of operations”); Ex. 2001 ¶ 31 (Mr. Easttom stating that an “application” is a specialized program designed to permit an end user to interface with a computer to perform a coordinated group of tasks applicable to the purpose of the application). Beyond the understanding of an “application” to a person of ordinary skill in the art within the context of the ’433 patent, we do not rely further on the expert testimony.

With regard to the second embodiment, Figure 4 of the ’433 patent, reproduced below, depicts details of local IVM server 202, illustrated generally in Figure 3.

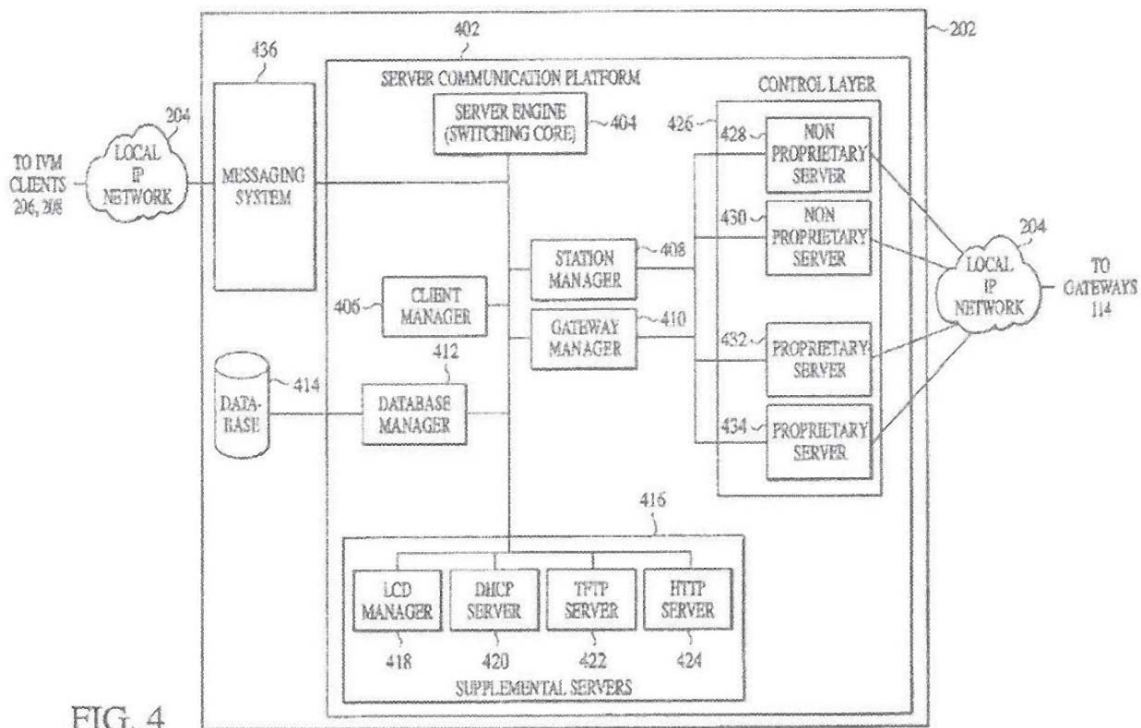

FIG. 4

Figure 4 illustrates local IVM server 202 that comprises server communication platform 402, messaging system 436, and database 414. Ex. 1001, 13:41–50. Client manager 406 controls IVM clients 206, 208, “providing contact presence (connection) information and message scheduling and delivery.” *Id.* at 15:2–5. Database manager 412 accesses database 414 and services requests to add, update, delete or retrieve database records from database 414. *Id.* at 13:53–54, 14:2–3. And database 414 “stores users (e.g., IVM clients as well as legacy telephone clients) that are known to the IVM server 202 via the database manager 412.” *Id.* at 13:62–64. Lastly, messaging system 436 communicates with IVM clients 206, 208 via the network and communicates with server engine 304 via message objects. *Id.* at 13:59–61, 14:5–7. The message objects communicate actions to the server engine, such as determining whether an IVM client is awake, disconnecting from the IVM client, processing an IVM

client message, and notifying IVM clients if the server goes down. *Id.* at 14:8–15.

From the above descriptions of Figures 3 and 4, we understand that the components of Figure 3 perform different functions from the components of Figure 4. Figure 4 addresses the server messaging functions and the management of client connections to the server. In contrast, Figure 3 focuses on the *client device functions* with regard to generating, transmitting, receiving, and storing instant voice messages, among others. Accordingly, the embodiment of Figure 3 is highly relevant to the scope of the independent claims 1 and 6 in that the embodiment provides the context for the operation of the recited components of the “instant voice messaging application.” Figure 3 also provides the context for the recited “application” as being located at the client device (as opposed to the server).

Petitioner has argued that the “instant voice messaging application” is not located at any particular location or device because the broadest reasonable interpretation of the claim language does not compel such an interpretation, and a “distributed” application resides in more than one physical location. Reply 2–3 (citing Ex. 1018, 32:16–18). Most notably, Petitioner argues that IVM client 208 is part of a larger global instant messaging system 500 (illustrated in Figure 5), where transport servers (604, 606) each includes a message database in which the instant voice message is saved. Reply 4–5 (citing Ex. 1001, Fig. 7, 22:53–58). Because the message database may be located in these transport servers, Petitioner contends the “instant voice messaging application,” which according to claim 1 includes a message database, cannot be located solely at the client device. *Id.* According to Petitioner, relying on Figure 3 to construe the scope of the

“instant voice messaging application” as being at the client device would be akin to importing that particular embodiment into the claims. *Id.*

We do not agree with Petitioner. Although the '433 patent Specification provides for a message database at the transport server, that database is for storing the messages of the one or more recipients that are not available, and, therefore, cannot receive instant voice messages. Ex. 1001, 22:53–63. When a user becomes available, database (storage) manager 710 retrieves the undelivered instant voice messages from the database, and client manager 706 delivers the messages to the designated, now available, recipients. *Id.* Thus, message database 710 at the transport server stores and retrieves instant voice messages upon command from the client manager 706, whereas message database 310, of Figure 3, stores and retrieves instant voice messages upon command of file manager 308. This distinction is significant because claims 1 and 6 directly link the recited “message database” to the “file manager,” and no other component of the disclosed system. Further, the recited “file manager” performs the “storing,” for example, “in response to a user request,” according to the claim language of claims 1 and 6. The '433 patent Specification lacks any description of the transport server’s message database or database manager storing instant voice messages in response to a user request. Indeed, the transport server does not store instant voice messages in the database in response to a user’s request, because it only stores messages in the database when the recipient is unavailable. In fact, the message database of the transport server stores messages at the request of client manager 706, and on condition that a recipient is not available. Ex. 1001, 22:53–63; *see also id.* at 8:38–43 (describing the local server in a similar manner, delivering messages to the

available recipients and temporarily storing the instant voice messages for unavailable recipients).

Further, the Specification contains no disclosure of “distributed” applications or programs or any other indication that the “instant voice messaging application” is a “distributed” application with components placed throughout the system (at clients and servers). Petitioner’s reliance on Figure 7 as supporting the contention of a “distributed” application, as discussed above, is unavailing. Other than having the same name, the message database of the transport servers (Figure 7) is a different message database from the one recited in claims 1 and 6 and described in Figure 3.

Finally, Dr. Forys’s testimony regarding the scope of the term “application,” as not restricted to the client device, is also unpersuasive. Dr. Forys opines that the ’433 patent does not describe any restriction of the application to be in any particular device, and that operations on multiple computer devices may fall within the context of the same overarching application. Ex. 1003 ¶ 94 (opining that the message database and the file management system may be on different devices than the client platform system). These explanations broaden the claim language to an unreasonable extent. The “broadest reasonable interpretation . . . is an interpretation that corresponds with what and how the inventor describes his invention in the specification.” *In re Smith Int’l, Inc.*, 871 F.3d 1375, 1382–83 (Fed. Cir. 2017); *see Microsoft Corp. v. Proxyconn, Inc.*, 789 F.3d 1292, 1298 (Fed. Cir. 2015). Even when giving claim terms their broadest reasonable interpretation, the Board cannot construe the claims “so broadly that its constructions are *unreasonable* under general claim construction principles.” *Microsoft*, 789 F.3d at 1298. “[T]he protocol of giving claims their broadest

reasonable interpretation . . . does not include giving claims a legally incorrect interpretation” “divorced from the specification and the record evidence.” *Id.* (citations and internal quotation marks omitted); *see PPC Broadband, Inc. v. Corning Optical Commc’ns RF, LLC*, 815 F.3d 747, 751–53 (Fed. Cir. 2016).

As explained above, the ’433 patent discloses the components of the instant voice messaging application as being client-based. Contrary to Petitioner’s argument and Dr. Forys’s testimony, none of the disclosed servers includes the components with the corresponding functions recited by the claims. Thus, from a reading of the claim language in the context of the Specification, it is unreasonable to broaden the “instant voice messaging application” as existing at a server or as having any of its recited components “distributed” throughout the system.

In reaching this conclusion, we are also mindful that,

[t]he correct inquiry in giving a claim term its broadest reasonable interpretation in light of the specification is not whether the specification proscribes or precludes some broad reading of the claim term adopted by the examiner. And it is not simply an interpretation that is not inconsistent with the specification. It is an interpretation that corresponds with what and how the inventor describes his invention in the specification, i.e., an interpretation that is consistent with the specification.

Smith Int’l, 871 F.3d at 1382–83 (citations and internal quotation marks omitted); *see also In re Suitco Surface, Inc.*, 603 F.3d 1255, 1259–60 (Fed. Cir. 2010). Under this guidance, we do not give Dr. Forys’s testimony (Ex. 1019 ¶ 94) any weight to the extent that it invites an interpretation that is inconsistent with the Specification. That testimony also urges reliance on the ’433 patent Specification as *not precluding* the broad, and factually

unsupported, reading of the claim proposed by Petitioner. Instead, we rely on the description of the invention as stated in the '433 patent Specification, especially with respect to Figure 3, and the plain reading of the claim language. *Suitco*, 603 F.3d at 1260 (“[C]laims should always be read in light of the specification and teachings in the underlying patent.”).

In sum, we determine that the “instant voice messaging application” is a client-based program. Our inquiry, however, does not end here, because Patent Owner argues that the claims are further directed to an *originating* client. PO Resp. 12–13; *see also id.* at 28 (arguing that Väänänen does not meet the claims because the cited disclosure focuses on the recipient not the sender). Patent Owner’s arguments in this regard focus on the claim language and the antecedent basis for the recited “instant voice message.” *Id.* at 12. In sum, Patent Owner contends that the claim recites “generating *an* instant voice message,” and, therefore, because the claim recites subsequently “*the* instant voice message,” the claim refers only to the “instant voice messaging application” that generates and transmits the instant voice message. *See id.* In other words, Patent Owner urges that we interpret the “instant voice messaging application” and its recited components as handling only instant voice messages that the client device sends, i.e. the “instant voice messaging application” is not met by pointing to a receiving device in the prior art.

The main problem with Patent Owner’s antecedent basis argument is that the claim is not internally consistent with the antecedents for the terms “instant voice message” and “instant voice messages.” For instance, the claims recite “an[/the] instant voice message” (singular) in referring to *generating, transmitting, and displaying*. Claim 1 then recites *storing* “the

instant voice message” (singular). However, claims 1 and 6 also recite *storing, deleting and retrieving* “the instant voice messages” (plural) from the message database in response to a user request. There is no indication that the plural “instant voice messages” refer only to generated and transmitted messages. Indeed, the claim language does not support this narrow interpretation. Although claim 6 recites compressing “the instant voice messages” (plural) to be transmitted, it recites decompressing “the instant voice messages [(plural)] *received* over the packet-switched network.”

Therefore, simply relying on antecedent basis is inconclusive because for some functions the claim refers to the singular (e.g., generated and transmitted) instant voice message, while for other functions (e.g., storing, deleting, and retrieving) the claim refers to plural instant voice messages. Another interpretation of the claim is more reasonable—that the “instant voice messaging application” of claims 1 and 6 are on a device that both originates *and* receives instant voice messages. While the “instant voice messaging application” *requires* certain functions characteristic of the originating device (e.g., generating and transmitting the instant voice message), the claim language does not limit the “instant voice messaging application,” *in all respects*, to the originating device. For example, the claims encompass a “file manager system” linked to *received* instant voice messages, in addition to *transmitted* instant voice messages. And claim 6 further recites decompressing *received* instant voice messages, in addition to compressing *transmitted* instant voice messages.

The Specification supports this interpretation of the claims. The ’433 patent describes the “message database” as storing *both* “the received

and recorded instant voice messages” and the “file manager” as accessing the message database and servicing requests from the user to “record, delete or retrieve messages to/from the message database.” Ex. 1001, 12:36–42. Thus, the recited “message database” (included in the “instant voice messaging application” in claim 1) stores the generated and transmitted instant voice message. However, the “file manager system” limitation, recited in claims 1 and 6, performs at least one of storing, deleting, and retrieving instant voice messages (plural) destined for or stored at the “message database,” regardless of whether the instant voice messages comprise messages transmitted from or received at the client device. The Specification broadly describes the “message database” in this manner—storing both types of messages: sent and received by the client. Ex. 1001, 12:36–42.

Accordingly, in the context of the Specification and following the natural reading of the claim language, giving the plural words their appropriate plain meaning, the “instant voice messaging application” is a client-based program, not limited to only an *originating* device, as discussed above.

2. *Messaging Database*

As stated above, claims 1 and 6 have differing recitations of a “messaging database.” Claim 1 recites the “instant voice messaging application” as including the “message database,” while claim 6 is silent in this regard. Neither party argues that the scope of these two claims is different, even though the claims include different language for this limitation. *See, e.g.*, Pet. 44 (Petitioner relying, for claim 6, on the same arguments and disclosures as for claim 1); *see also id.* at 58 (Petitioner

arguing for the Väänänen-based ground that it would have been obvious to store voice messages at the subscriber terminal); Tr. 28:8–17 (Petitioner arguing that all presented grounds allege that the functionality existed within the client device). Accordingly, we need not resolve whether the “message database” has different scope for claim 6.

B. ANALYSIS OF ASSERTED GROUNDS

All of Petitioner’s asserted grounds are based on obviousness. A patent claim is unpatentable as obvious under 35 U.S.C. § 103(a) if the differences between the claimed subject matter and the prior art are such that the subject matter, as a whole, would have been obvious at the time the invention was made to a person having ordinary skill in the art to which said subject matter pertains. *KSR Int’l Co. v. Teleflex Inc.*, 550 U.S. 398, 406 (2007). The question of obviousness is resolved on the basis of underlying factual determinations including: (1) the scope and content of the prior art; (2) any differences between the claimed subject matter and the prior art; (3) the level of ordinary skill in the art; and (4) when in evidence, objective evidence of nonobviousness. *Graham v. John Deere Co.*, 383 U.S. 1, 17–18 (1966).

As the Supreme Court explained in *KSR*, an invention “composed of several elements is not proved obvious merely by demonstrating that each of its elements was, independently, known in the prior art.” 550 U.S. at 418. Rather, “it can be important to identify a reason that would have prompted a person of ordinary skill in the relevant field to combine the elements in the way the claimed new invention does.” *Id.* In other words, “there must be some articulated reasoning with some rational underpinning to support the legal conclusion of obviousness.” *Id.* (quoting *In re Kahn*, 441 F.3d 977,

988 (Fed. Cir. 2006)). Accordingly, the U.S. Court of Appeals for the Federal Circuit has made clear that a petitioner in an *inter partes* review proceeding cannot “satisfy its burden of proving obviousness” by “employ[ing] mere conclusory statements” and “must instead articulate specific reasoning, based on evidence of record” to support an obviousness determination. *In re Magnum Oil Tools Int’l*, 829 F.3d 1364, 1380–81 (Fed. Cir. 2016).

1. *Level of Ordinary Skill in the Art*

In determining the level of ordinary skill in the art, various factors may be considered, including the “type of problems encountered in the art; prior art solutions to those problems; rapidity with which innovations are made; sophistication of the technology; and educational level of active workers in the field.” *In re GPAC Inc.*, 57 F.3d 1573, 1579 (Fed. Cir. 1995) (internal quotation and citation omitted). In that regard, Petitioner proffers, via its declarant, Dr. Forys, that a person having ordinary skill in the art would have “a B.S. degree in Electrical Engineering, Computer Science, or an equivalent field as well as at least 3–5 years of academic or industry experience in communications systems, particularly in messaging systems, data networks including VoIP and mobile telephony, or comparable industry experience.” Pet. 8 (citing Ex. 1003 ¶ 30). Patent Owner proffers that a person of ordinary skill in the art would have a B.S. degree related to computer technology and two years of experience with communications technology, or four years of experience without a degree. PO Resp. 6 (citing Ex. 2001 ¶ 12). Dr. Easttom disagrees with the level of ordinary skill proffered by Petitioner, to the extent it requires more than four years of academic or industry experience “exclusively” in the fields of VoIP and

mobile telephony. Ex. 2001 ¶ 13. Nevertheless, Dr. Easttom concludes that he qualifies as a person of ordinary skill in the art under Dr. Forsy's definition. *Id.*

Patent Owner's proffered level of ordinary skill in the art focuses too generally on experience in "communications technology." The enunciation of such experience is too generic to be useful in determining the level of ordinary skill in the art under any of the *GPAC* factors. For instance, experience with "communications technology" is untethered to addressing problems and solutions in facilitating short messaging services, such as in Vuori, or to whether active workers in the appropriate field would manifest such a general experience in "communications technology." Vuori, for instance, focuses on facilitating short messaging service in the context of a wireless telecommunication network. *See* Ex. 1005 ¶¶ 5–7. Therefore, we cannot ignore that the field of work would be more narrow than generally "communications technology."

We find that Petitioner's assessment is proper and consistent with the level of ordinary skill in the art at the time of the invention as reflected in the prior art in the instant proceeding. *See Okajima v. Bourdeau*, 261 F.3d 1350, 1355 (Fed. Cir. 2001). For example, Vuori (Ex. 1009) is directed to an instant messaging system in the context of telecommunication and computer networks, such as a Global System for Mobile Communications ("GSM"), General Packet Radio Service ("GPRS"), Universal Mobile Telecommunication Systems ("UMTS"), and the Internet. Ex. 1005 ¶¶ 35–39, Figs. 3, 6; *see also* Ex. 1005 ¶¶ 1–4 (addressing messaging systems that use the Internet as a telecommunication and/or computer network). Thus, it is evident from the prior art that Petitioner's assessment is

appropriate because, in addition to a certain degree, a person of ordinary skill in the art would have experience in communications systems, particularly in messaging systems, data networks including VoIP and mobile telephony, or comparable industry experience.

Consequently, we adopt Petitioner's assessment of the level of ordinary skill in the art.

2. *Overview of Asserted Prior Art*

a. *Abburi (Ex. 1005)*

Abburi is entitled "Audio Messaging System and Method," and is directed more particularly to audio (including voice) messaging between individuals through telecommunications and/or computer networks.

Ex. 1005, [54], ¶ 1. Abburi recognizes that "the ability to conveniently record and send voice and other audio messages via any desired type of communication device (e.g., from computer devices in addition to phone devices), and to promptly receive such messages in audio form via any desired type of communication device, is still lacking." *Id.* ¶ 5. Abburi solves this need by providing a system that upon receiving the audio message on behalf of a recipient, accesses a user profile to determine how the intended recipient should be contacted. *Id.* ¶ 6.

Figure 2 of Abburi, reproduced below, illustrates one embodiment of a system for implementing the method of supporting audio messaging between individuals. *Id.* ¶¶ 17, 23.

FIG. 2

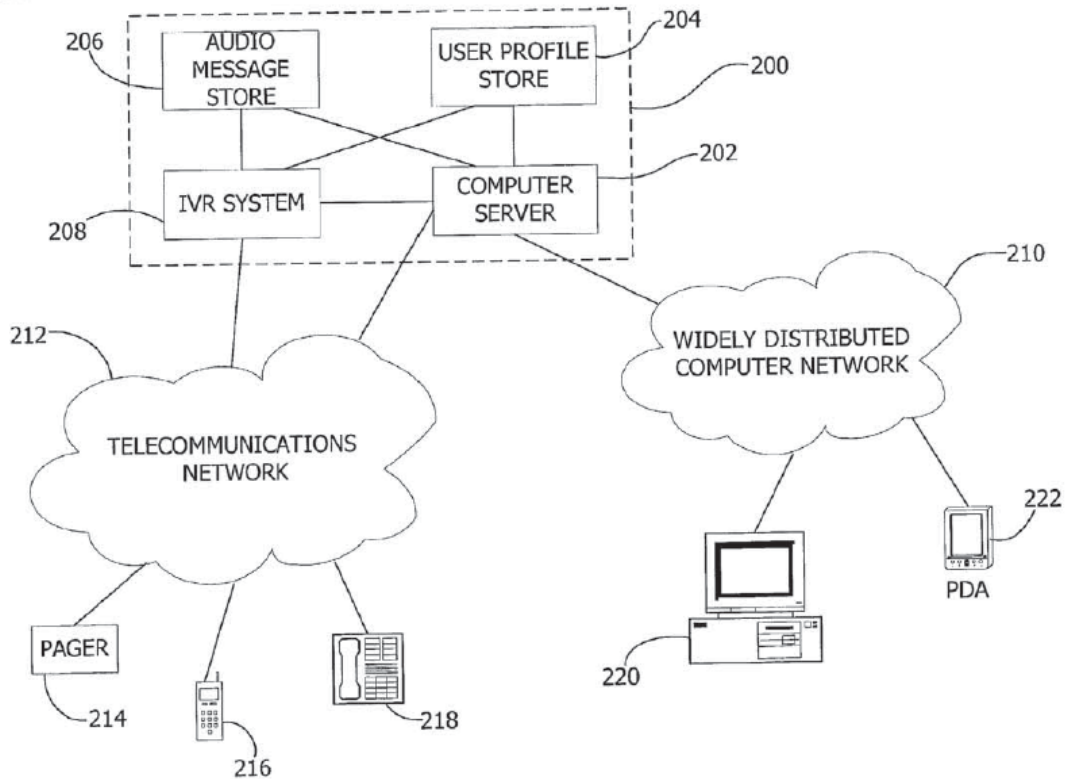

Figure 2 depicts system 200 including computer server 202, user profile store 204, audio message store 206, and interactive voice response (“IVR”) system 208. *Id.* ¶ 23, Fig. 2. As a result of the connections of IVR system 208 and computer server 202 with the depicted telecommunication network 212 and widely distributed computer network 210, system 200 can receive audio messages from and send audio messages to any device connected to computer network 210 or telecommunications network 212. *Id.*

The user profile store contains configuration settings for each user of system 200. *Id.* ¶ 25. A person interested in sending a voice or other audio message to a particular individual dials into the IVR system. *Id.* ¶ 30. Once the intended recipient is specified, the caller may speak to provide an audio message to the IVR system, which stores the message in audio message store

206. *Id.* ¶ 31. If the user profile indicates that the intended recipient should receive an email notification, the IVR system sends appropriate information to the computer server, which then produces and sends the email notification. *Id.* The audio messages are delivered via audio streaming or as an electronic audio file. *Id.* ¶ 32.

In one embodiment, Abburi describes the user device including a network presence application for maintaining a “subscription” with the system when the device is connected to the computer network. *Id.* ¶ 42. With this application, “system 200 may determine whether the intended recipient of the message has a presence on the computer network 210 . . . and, if so, send an electronic message (e.g., an email message) notifying the intended recipient of the received audio message.” *Id.* Alternatively, if several of the user devices include the application, each such device receives, when connected to computer network 210, information from system 200 indicating which of the corresponding user’s “buddies” or contacts have a presence on computer network 210 at that time. *Id.* ¶ 43. When a user accesses system 200 via IVR system 208, the IVR system advises the user as to which of his buddies or contacts are online.

b. Holtzberg (Ex. 1007)

Holtzberg is entitled “Method, System, and Article of Manufacture for Bookmarking Voicemail Messages.” Ex. 1007, [54]. Holtzberg relates to audio recording devices, and in particular, to voicemail systems that permit users to bookmark messages during message playback. *Id.* at 1:7–9, 1:61–63. The “[b]ookmarks can be set by entering appropriate touch-tone or voice commands.” *Id.* at 1:64–65. In operation, a user connects to the voicemail system to access the user’s voicemail box. *Id.* at 2:4–11. During

playback of a voicemail message, the user can enter a command to set a voicemail bookmark by using one or more touch-tone digits or voice commands at the user's telephone. *Id.* at 2:11–16. “The voicemail system responds to this command by setting a bookmark pointer corresponding to the message being played back.” *Id.* at 2:16–19.

Holtzberg discloses a telecommunication system, shown in Figure 2 (reproduced below) in connection with its voicemail bookmark operation. *Id.* at 2:40–42.

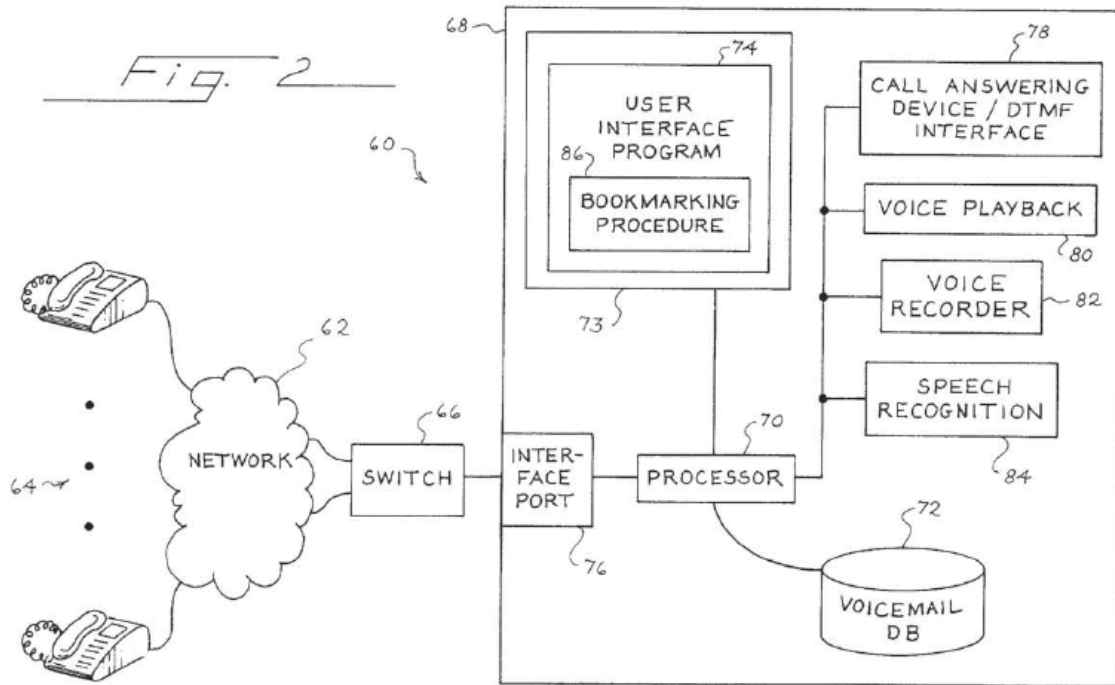

Figure 2 depicts telecommunication system 60 including terminal units 64 in communication with switch 66 over a commercially available telecommunication network 62. *Id.* at 2:42–47. Switch 66, which is located at a private branch exchange (“PBX”) or central office, allows terminal units 64 to access the voicemail services of voicemail system 68. *Id.* at 2:48–52. Voicemail system 68 can be a voicemail server that includes, among other features, a voicemail database. *Id.* at 2:53–61. For each user, a

voicemail box, associated with the user's User ID, is stored in voicemail database 72. *Id.* at 3:5–8. A message ID identifies the voicemail messages stored in the database for the user with the associated User ID. *Id.* at 3:8–10. In addition, one or more bookmark IDs are associated with the User ID for identifying voicemail bookmarks associated with the owner of the voicemail box. *Id.* at 3:10–12.

c. Vuori (Ex. 1009)

Vuori is entitled “Short Voice Message (SVM) Service Method, Apparatus and System.” Ex. 1009, [54]. According to Vuori,

Tiresome entry of numerous letters of the alphabet into a hand-held device for assembling a short text message for transmission via a short message service (SMS) to a second terminal is avoided by the sending of a short voice message (SVM). The SVM is recorded in the sending terminal and sent to a SVM service center (SVMSC). The SVMSC may notify the intended recipient of the arrival of the SVM and await acceptance before sending it. The second terminal may then commence a bidirectional communication so that an instant voice message session can be established. Alternatively, the problem can be overcome by converting the spoken SVM to text in the user terminal by means of voice recognition software and sending the converted text to the recipient by means of the traditional SMS infrastructure for display as text or for playback as text converted to voice.

Id. at Abstract.

Figure 2 of Vuori, reproduced below, illustrates the short voice messaging method. *Id.* ¶ 20.

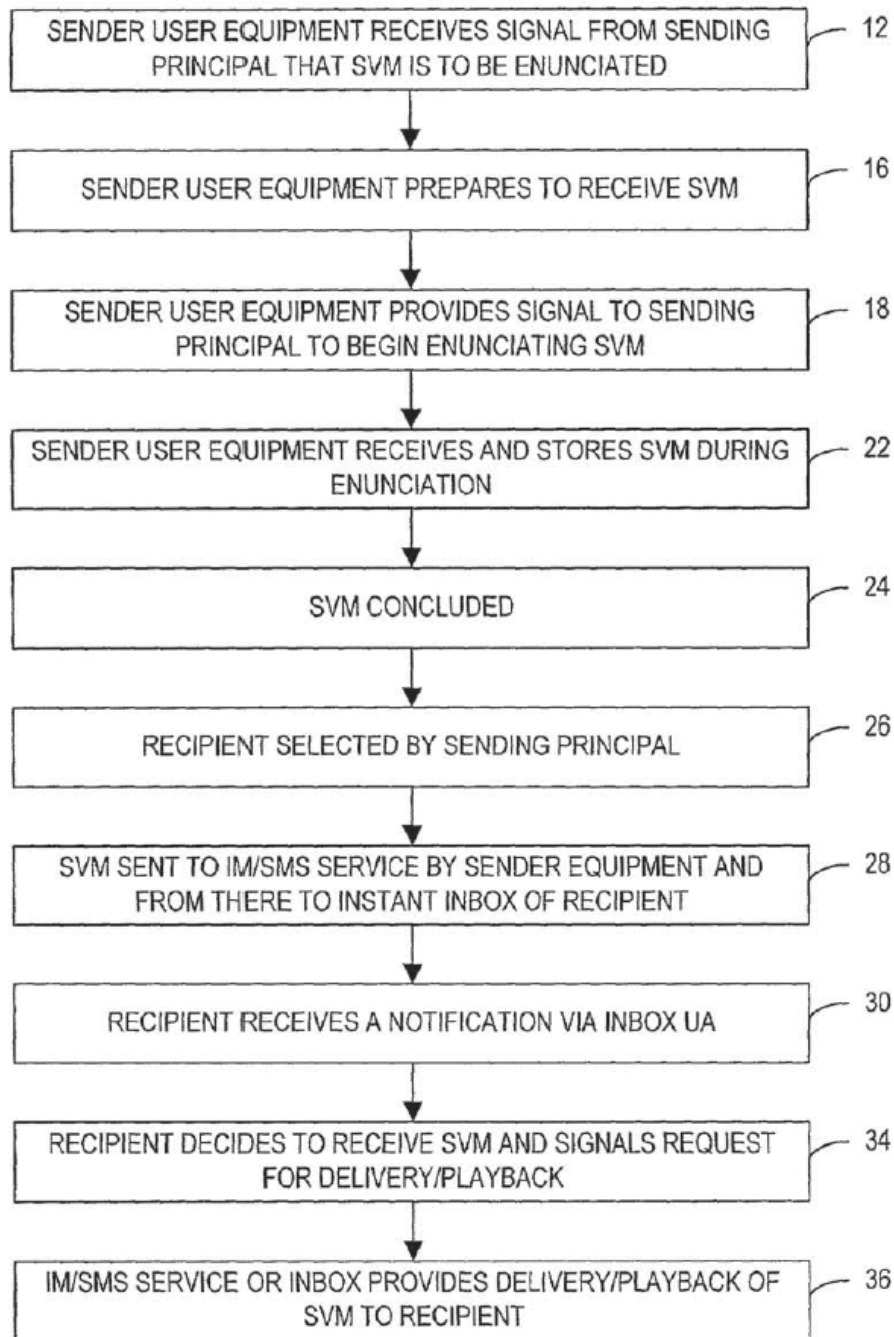

FIG. 2

According to Figure 2, a user initiates a SVM by pressing a menu key on a user equipment, which prepares to receive the SVM and emits a beep sound to alert the user he may commence speaking. *Id.* ¶ 32. The user

equipment receives and stores the SVM. *Id.* The user selects one or more intended recipients and initiates the transfer. *Id.* ¶ 33. The SVM is sent to the SVMSC, “which determines the availability of the one or more intended recipients.” *Id.* ¶ 34. The SVMSC sends the SVM immediately to the intended recipients who are available, and continues attempting to send it to those not available until they become available or until a time out occurs. *Id.* Alternatively, the SVMSC notifies the available recipients that an SVM has been received, and the recipient may decide to decline or accept the SVM received from the sender. *Id.* ¶ 35. In the embodiment where the SVMSC sends the SVM directly to the recipient, the intended recipient has acquiesced to availability by previously joining a “buddy list” or otherwise has subscribed to the service. *Id.*

d. Väänänen (Ex. 1006)

Väänänen is entitled “Voicemail Short Message Service Method and Means and a Subscriber Terminal.” Ex. 1006, [54]. More specifically, Väänänen concerns instantaneous voice mail between Internet compatible computers, personal digital assistants, telephones, and mobile stations. *Id.* at 1:8–11. Further, Väänänen notes that prior art subscriber terminals did not allow the use of audio features with an Internet connection and that for prior art voicemail systems, a specific voicemail central server was an essential requirement that introduced unnecessary network hardware. *Id.* at 1:34–42.

In one embodiment, the method of Väänänen is “arranged with a mobile station” or more specifically, for example, a computer program within a SIM card in the mobile station. *Id.* at 5:42–45, 10:3–8. A message recipient (or several recipients or group) may be chosen from the memory of the SIM card or the memory of the mobile station, or may be input into the

mobile station. *Id.* at 5:47–51, 10:8–12. When a user presses a button on the mobile station, a data file is recorded, using a media player/recorder, from the dictation, voice, or video. *Id.* at 10:12–17.

Figure 6, reproduced below, illustrates user interface 600 of a subscriber terminal, such as a mobile station. *Id.* at 9:38–41.

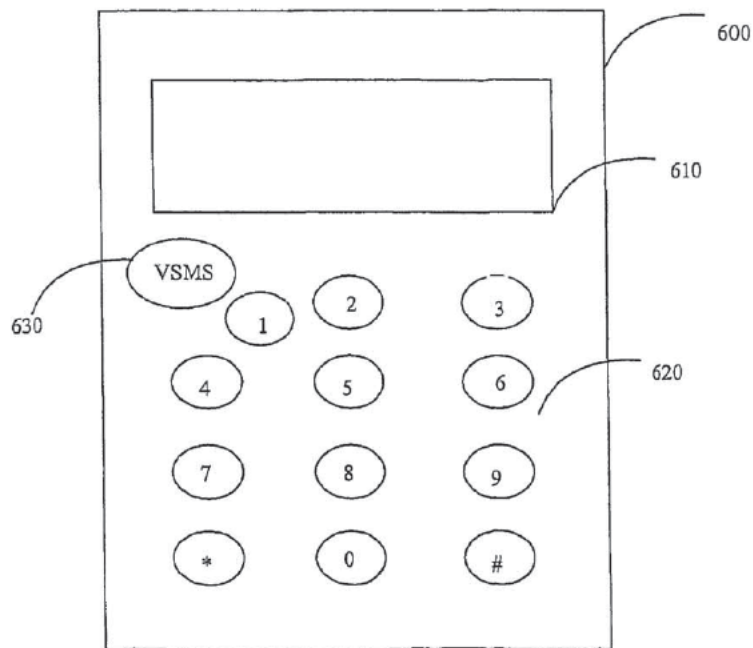

Figure 6 depicts user interface 600 including voicemail short message service (“VSMS”) button 630 and screen 610. *Id.* at 9:41–45, 9:62–65. The release of the VSMS button finishes the recording and sends the file with the message to the recipient or dials the telephone number of the recipient in order either to play the message back to the recipient or to leave a voicemail with the message for the recipient. *Id.* at 10:14–24. The recipient plays the packet stream in real time or reassembles the data file. *Id.* at 7:1–3.

3. Differences Between the Prior Art and Claimed Subject Matter—Abburi-Based Grounds

Three of Petitioner’s asserted grounds rely primarily on Abburi as teaching or suggesting the limitations of the challenged claims, except for, at least, the following recited limitations: “message database” and “database record” (claims 1, 2); “instant voice messaging application [that] displays at least one of the plurality of instant voice messages” (claim 3); “encryption/decryption system” (claim 5); and “compression/decompression system” (claim 6). Pet. 12–47. Petitioner relies on Holtzberg, Vuori, and Logan as disclosing the missing limitations.

Petitioner alleges that Abburi’s user device 300 is configured to record an audio message locally and transmit the message to the system. Pet. 20–24. Thus, Petitioner contends that Abburi’s user device 300 includes an “instant voice messaging application,” with a “client platform system” for generating an instant voice message and a “messaging system” for transmitting the instant voice message. *Id.* Petitioner’s allegation is consistent with our claim construction of the “instant voice messaging application,” because Abburi’s user device 300 is a client device.

Patent Owner, however, challenges Petitioner’s mappings of the “message database” at the client device. PO Resp. 19–28. In this regard, the Petition points to two instances of “storing audio messages” in Abburi in an attempt to show the required “message database” at the client device. Pet. 26. First, Petitioner argues that Abburi’s user device is able to send and receive audio messages because Abburi states that a “recipient can store and subsequently playback at his or her option” the audio file. *Id.* (citing Ex. 1005 ¶ 32). Second, Petitioner argues that Abburi teaches recording an

audio message in an audio file and transferring the audio file to the system. *Id.* at 26–27 (citing Ex. 1005 ¶¶ 8, 40). Petitioner does not allege, however, that either of these portions of Abburi discloses storing in a “message database.” Furthermore, testimony from Mr. Easttom explains that temporary storage and database storage are structurally different and function in different ways to achieve different results. Ex. 2001 ¶ 48. Therefore, we find that neither of Petitioner’s two “storing” examples in Abburi teaches the “message database” limitation of claims 1 and 6. *See* Dec. 17 n.2.

As an alternative, Petitioner asserts that “[t]o the extent Abburi does not explicitly teach that the audio message is stored *in a* database at user device 300, storing voice messages in a database was well-known in the prior art, e.g., as explicitly taught in Holtzberg.” Pet. 27 (citing Ex. 1003 ¶ 107). According to Petitioner, Holtzberg teaches a voicemail database. *Id.* at 28 (citing Ex. 1007, 3:5–8, Fig. 3). We agree with Petitioner that Holtzberg discloses a database for storing voicemail messages. *Id.* at 29 (citing Ex. 1003 ¶ 108). The remaining question is whether it would have been obvious “to *incorporate* Holtzberg’s database structure *into* Abburi.” *Id.* (emphasis added).

The rationale proffered in the Petition is that a person of ordinary skill in the art would have been motivated to combine storing messages in a database in Abburi’s user device “to improve the organization and retrieval of audio messages stored on a user’s device.” *Id.* (citing Ex. 1003 ¶ 109). At the outset we note that Petitioner’s contention of obviousness relies on *incorporation in Abburi’s user device* of a structural element taught in Holtzberg, a voicemail database. *Id.* The Holtzberg voicemail database,

however, is a centralized database, located within the central voicemail server, not at the terminal units. Ex. 1007 ¶ Fig. 2. As Patent Owner points out, and we agree, terminal units of Holtzberg access their voicemail by calling into the voicemail system, which is centralized. PO Resp. 24 (citing Ex. 1007, 2:7–8). According to Patent Owner, Petitioner’s rationale to incorporate these teachings fails for many reasons. See PO Resp. 21–28 (citing Ex. 2001 ¶¶ 47–56).

Patent Owner argues that neither Abburi nor Holtzberg teaches storing the audio/voicemail messages locally at the client device, and Petitioner’s argument that it would have been obvious to store locally at the client of Abburi has no merit. PO Resp. 24–25; Ex. 2001 ¶¶ 50, 53. We agree with Patent Owner. As stated above, Abburi teaches a centralized audio message store, and Holtzberg teaches a centralized voicemail database. Even though Abburi states that an audio message may be recorded locally, the *storage* of that message, nevertheless, is in the disclosed, centralized audio-message store. Ex. 1005 ¶¶ 8, 32, 40. Temporary storage, suggested by Abburi, as noted above, is not storing at a “message database” either. Our analysis of Petitioner’s rationale of obviousness searches for a *reason* a person of ordinary skill in the art would de-centralize Abburi’s storage of voice messages, and instead store voice messages in a database in user devices. Or, absent reasons to de-centralize storage in Abburi, we look for a *reason why* a person of ordinary skill in the art would relocate a centralized voicemail database, like the one in Holtzberg, to reside instead in user devices.

We find Petitioner’s rationale wanting. Petitioner proffers expert testimony of a reason to combine: “to improve the organization and

retrieval of audio messages stored on a user’s device.” Ex. 1003 ¶ 109. Dr. Forys also states that “it would have been obvious to incorporate Holtzberg’s database structure into Abburi because such incorporation amounts to nothing more than applying a known technique (e.g., storing voice messages in a database) to a known device (e.g. the message recipient’s device in Abburi) ready for improvement to yield predictable results (a user device storing audio messages in a database).” *Id.* None of the proffered testimony is persuasive, and because it is not supported by either explanation or supporting facts, we give it little to no weight. 37 C.F.R. § 42.65(a) (“Expert testimony that does not disclose the underlying facts or data on which the opinion is based is entitled to little or no weight.”).

First, there is no explanation as to *why* a person of ordinary skill in the art would either de-centralize Abburi or relocate the database in Holtzberg to achieve the “user device storing audio messages in a database.” Dr. Forys’s conclusion that the claimed message database would have been obvious is unexplained and belies the specific teachings in both Abburi and Holtzberg that rely on the architecture of their systems as having centralized storage. Without “a reasoned explanation that avoids conclusory generalizations,” Dr. Forys’s testimony is not sufficient. *See Arendi S.A.R.L. v. Apple Inc.*, 832 F.3d 1355, 1362 (Fed. Cir. 2016) (quoting *Perfect Web Techs., Inc. v. InfoUSA, Inc.*, 587 F.3d 1324, 1329 (Fed. Cir. 2009)).

Patent Owner instead correctly points out that Abburi expressly relies on the server-side audio message store, with no indication that a local audio message store is either warranted or desirable. PO Resp. 20–22 (citing Ex. 1005 ¶¶ 8, 24, 31, 33, 39, 40; Fig. 2). We agree with Patent Owner that Abburi as a whole teaches that the function of the disclosed system is to

centralize the storage of the audio messages. *See* Ex. 1005 ¶ 31 (“This audio message is stored by the IVR system 208 in the audio message store 206.”); ¶ 39 (“The audio message is routed through the network interface 310 and transmitted . . . to the [server-side] system 200 for recording, storage and delivery to the intended recipient(s).”). Although Abburi discloses an alternative embodiment where the audio, instead of being routed to the server-side system 200 for recording, is recorded locally into an audio file, that audio file is nevertheless stored at the server-side audio message store. Ex. 1005 ¶ 39. Abburi’s alternative embodiment suggests that some type of data storage may be used *during* the recording in order for an audio file to be assembled, compressed, and prepared for transmission. *See* Reply 11 (Petitioner arguing that Abburi’s audio file is stored for some period of time). However, we are not persuaded that the existence of a memory for recording an audio file suggests either de-centralizing the audio message store or that the audio file would be stored in a database. *See* Ex. 2001 ¶ 48 (Mr. Easttom explaining that the use of a RAM, temporary storage, is structurally and functionally different from a message database).

In the Reply, Petitioner states that “Abburi’s storage of audio messages at a server is irrelevant and is not mutually exclusive of storage at the client device.” Reply 10. We do not agree with this statement and find that Abburi contradicts this assertion. For example, Abburi is explicit that even the locally recorded audio message must be stored at the server-side audio message store. *See* Ex. 1005 ¶ 39 (describing that system 200 records, stores and delivers the audio message), ¶ 40 (describing that notwithstanding the local recording, the audio message is transmitted to the system 200, teaching thus that system 200 stores the audio file and delivers the message

as described in paragraph 39). Accordingly, we find no factual support for Petitioner’s rationale for Abburi to use a de-centralized audio message store or to include a local database, at the user device.

Petitioner also does not explain Holtzberg sufficiently to support the rationale proffered through Dr. Forys’s testimony. Petitioner does not allege, nor do we find support for the contention, that Holtzberg’s voicemail database would or could *be relocated and distributed* so that each user device would have its own message database. The Petition alleges a general “incorporation” of Holtzberg’s database into the user device of Abburi without explaining *how* this would be achieved, especially considering the structural requirement in Holtzberg, of a centralized voicemail database, as paramount to Holtzberg’s operation. For example, Patent Owner and Mr. Easttom, whose testimony we credit in this regard, proffer that the voicemail database services all the users of the system, and a redesign of the voicemail database would be needed in order to fracture the centralized voicemail database and to distribute certain functions to each user device. PO Resp. 25–26; Ex. 2001 ¶¶ 52–54. Thus, the asserted combination is not only an unexplained redesign of Abburi, but also an unexplained redesign of Holtzberg’s database. That is, Petitioner does not explain either of these modifications in *its Petition* or through the First Forys Declaration.

Here we note that Petitioner argues in its Reply that Dr. Forys provides “specifics of how and why” Holtzberg is integrated into the system of Abburi. Reply 15. The argument and citations are not persuasive. The Reply Forys Declaration (Ex. 1019 ¶¶ 12–14) provides *new* reasons for a motivation to combine (for example, motivation to provide storage at *both the client and server* for sent and received messages). This testimony does

not just explain the rationale provided in the Petition (focused on incorporation of Holtzberg’s database at the user device of Abburi). Rather, Dr. Forys’s reply explanation provides an expanded rationale that is *different* from the rationale stated in the Petition. For example, Dr. Forys opines that a person of ordinary skill in the art “would understand that the communication link between the user device and the server system may be down or disrupted from time to time, and the recorded audio messages to be sent to the system must be stored until communication is reestablished.”

Ex. 1019 ¶ 13. Dr. Forys’s opinion does not respond appropriately to the argument by Patent Owner that the teachings of Abburi and Holtzberg would have led away from incorporating a database at the client device. Rather, the reply opinion testimony diverges from the Petition’s rationale of improving organization and retrieval of audio at the client device. Put another way, the reasoning of redundancy of storage to account for communication failures between the server and the client is another rationale—different and distinct from the rationale asserted in the Petition.³ The Reply is not responsive to the teaching away argument, and it has come too late in the proceeding. *See* 37 C.F.R. § 42.23(b) (“A reply may only respond to arguments raised in the corresponding opposition or patent owner response”); Office Trial Practice

³ We find the further reasons in the Reply Forys Declaration similarly problematic. For instance, Dr. Forys opines that it would be convenient to playback older messages to recall their content, and would enable the user to track messages and avoid repeated queries to the audio message store. Ex. 1019 ¶ 13. Again, the Petition and the First Forys Declaration neither state nor explain a rationale based on convenience of local storage or of conservation of server resources. Indeed, the only reason or explanation timely provided addresses the generic benefit of organization and retrieval of data. Pet. 29.

Guide, 77 Fed. Reg. 48,756, 48,767 (Aug. 14, 2012) (“While replies can help crystalize issues for decision, a reply that raises a new issue or belatedly presents evidence will not be considered and may be returned.”).

Accordingly, we will not consider the new theories of obviousness in the Reply and Reply Fors Declaration. *See Ariosa Diagnostics v. Verinata Health, Inc.*, 805 F.3d 1359, 1367–68 (Fed. Cir. 2015) (finding reasonable the Board’s judgment about when a Reply contention crosses the line from the responsive to the new); *see also* Tr. 89:5–90:5 (counsel for Petitioner offering argument regarding whether Reply falls outside the permissible scope and responding that “you could eliminate our petitioner reply entirely and we still think that there is a complete showing that all claim elements are rendered obvious under all five grounds, both combinations”).

We further note our disagreement with Petitioner’s argument that Holtzberg’s database structure is not specific to centralized storage and that Patent Owner has not “explained why the structure would in any way be incompatible with a database located on a client device.” Reply 14. The burden is on Petitioner to explain and prove that a person of ordinary skill in the art would have recognized the benefit of using Holtzberg’s database, and how and why this would have been accomplished to yield the compatibility Petitioner alleges. *See* 35 U.S.C. § 316(e); *Magnum Oil*, 829 F.3d at 1380–81 (holding that because petitioner “bears the burden of proof,” the Board “must base its decision on arguments that were advanced by [petitioner]”); 35 U.S.C. § 312(a)(3); 37 C.F.R. §§ 42.22(a)(2), 42.104(b)(4)–(5). It is not Patent Owner’s burden to rebut a generic assertion of incorporation in more detail than that argued by Petitioner.

Second, Petitioner’s proffered reason of improvement in organization and retrieval of audio messages stored on a user’s device is not persuasive. Pet. 17–18; Reply 10. On its surface, we find that the allegation of improvement of organization and retrieval of messages at best shows a *generic* benefit of using a database. However, we find that this generic benefit does not outweigh, on balance, Abburi’s trade-offs concerning scalability, concentrated resources of a centralized storage, simplicity of design, and centralized functionality. *See* PO Resp. 26 (arguing the combination would result in relocating and multiplying the centralized storage design to each client which would complicate the design and vitiate scalability); Ex. 2001 ¶ 54; *see Winner Int’l Royalty Corp., v. Wang*, 202 F.3d 1340 (Fed. Cir. 2000) (stating that motivation to combine requires weighing the trade-offs of desirability: “the benefits, both lost and gained, should be weighed against one another”). That is, we agree with Patent Owner’s arguments and evidence to show that Abburi would have to be redesigned to account for additional functionality at the user device, where the trade-offs are the complexity of replication of data across the entire system. PO Resp. 26; Ex. 2001 ¶ 54. To avoid duplication, if functionality of the server-side message store is distributed throughout the devices, the scalability of design and the ease of centralized functionality would be compromised. In particular, we find that a person of ordinary skill in the art would find organizing voice mails at the user device mildly desirable, but not outweighing the particular benefit of centralized audio message use of Abburi (being able to centrally record, store, and deliver all the messages from all the users regardless of the type of device being used, including a *telephone*). *See* Ex. 1005 ¶¶ 5–7.

In sum, Patent Owner’s argument and evidence concerning the undesirability of modifying Abburi’s user device to include the Holtzberg voicemail database shows that Petitioner’s reasoning of improved organization of retrieval of messages is not persuasive.

As noted above, a petitioner in an *inter partes* review proceeding cannot “satisfy its burden of proving obviousness” by “employ[ing] mere conclusory statements” and “must instead articulate specific reasoning, based on evidence of record” to support an obviousness determination. *Magnum Oil*, 829 F.3d at 1380–81. The “factual inquiry” into the reasons for “combin[ing] references must be thorough and searching, and the need for specificity pervades” *In re Nuvasive, Inc.*, 842 F.3d 1376, 1381–82 (Fed. Cir. 2016) (internal quotations and citations omitted). A determination of obviousness cannot be reached where the record lacks “explanation as to *how* or *why* the references would be combined to produce the claimed invention.” *Trivascular*, 812 F.3d at 1066; *see Nuvasive*, 842 F.3d at 1382–85; *Magnum Oil*, 829 F.3d at 1380–81.

In this proceeding, we find that Petitioner’s reasons explaining why a person of ordinary skill in the art would have combined the portions of Holtzberg with Abburi are not persuasive in light of the teachings of those references and the testimonial evidence proffered through Mr. Easttom, as explained above. The lack of persuasive evidence on this issue warrants our determination that Petitioner has failed to prove by a preponderance of the evidence that independent claims 1 and 6 are unpatentable over the combination of Abburi and Holtzberg as asserted in the Petition.

None of the remaining references in the Abburi-based grounds are alleged to cure the deficiencies noted above. Consequently, we conclude

that Petitioner has failed to show obviousness of any of the challenged claims under the Abburi-based grounds.

4. *Differences Between the Prior Art and Claimed Subject Matter—Väänänen-Based Grounds*

The remaining unpatentability grounds rely on the combination of Väänänen with other references. Pet. 3, 47–73. We focus our analysis of these grounds on Petitioner’s contentions regarding the “message database” limitations because they are dispositive.

a. Claim 1 – “a message database storing the instant voice message”

As discussed above in our claim interpretation analysis, claim 1 expressly requires storing “the instant voice message” in the “message database” that is included in the “instant voice messaging application.” See *supra*, Section II.A. We determined that the “instant voice messaging application” is client-based. *Id.* We also determined that for claim 1, the “message database” stores the transmitted message. Thus, claim 1 requires a client-based “message database” that stores the generated and transmitted instant voice message.

Petitioner has not demonstrated that Väänänen alone or in combination with Holtzberg satisfies these claim requirements. Petitioner first points to Väänänen’s embodiment of a *receiving* subscriber terminal that reassembles the received packet stream into a data file, which can be stored to the memory of the *receiving* subscriber terminal. Pet. 58 (citing Ex. 1006, 6:28–42). Petitioner’s argument and evidence shows that Väänänen’s subscriber terminal stores the data file that contains the received voice message. But the *receiving* subscriber terminal (which includes the

recited “instant voice messaging application” (Pet. 52)) is not the same subscriber terminal that *generates and transmits* the instant voice message as required by claim 1. *See* PO Resp. 28–29 (Patent Owner arguing that storing only received messages does not disclose or suggest a “message database storing the instant voice message,” citing Ex. 2001 ¶¶ 57–58).

In Reply, Petitioner expands on its theory of obviousness by pointing to another disclosure of Väänänen where before the transmission of the data file, the recorded voice message is “written to a data file.” Reply 20 (citing Ex. 1006, 4:32–36 and the Reply Forsys Declaration ¶ 20, and further citing a summary of Väänänen at Pet. 48). This evidence thus appears to map the *sending* subscriber terminal to the “instant voice messaging application” whose “message database” stores the instant voice message. Petitioner argues that “Patent Owner ignores this teaching of Väänänen” when arguing that the Petition does not show how Väänänen discloses the “message database” of claim 1. But we fail to see how Patent Owner had reason to take the Reply argument into account when it was not presented previously, in the Petition. This Reply argument is not just a mere confirmatory disclosure or a further explanation of the Petition’s mapping of the claim to the prior art. This Reply argument belatedly maps the *sending* subscriber terminal, instead of the *recipient* terminal as referenced in the Petition, to the “instant voice messaging application.”

Nevertheless, even apart from its untimeliness, Petitioner’s reply argument fails because Väänänen’s sending subscriber terminal does not disclose storing the instant voice message as Petitioner argues. Väänänen’s subscriber terminal does include a random access memory (“RAM”) that may store the recorded voice message. *See, e.g.*, Ex. 1006, 10:8–19 (“[T]he

message itself is recorded to the RAM memory of the SIM card and/or the mobile station.”). We find, however, that the RAM holds the message temporarily, until the file containing the message is *transferred* to the recipient. *Id.* at 10:19–24. Indeed, at best, Väänänen explains that the subscriber terminal may keep in memory only a message that *has not been delivered*, stating that expiration conditions may be employed. *Id.* at 10:44–49. Thus, Väänänen contemplates that its subscriber terminals do not store the generated and *transmitted* instant voice messages. As stated above, claim 1 requires storing, in the “message database” of the client device, the *generated and transmitted* instant voice message. Consequently, even Petitioner’s reply argument does not show that Väänänen teaches or suggests the claim 1 “message database” limitation.

Furthermore, merely *storing* a data file in a memory of the subscriber terminal does not teach or suggest storing the instant voice message in a “message database.” *See* Pet. 58. The claim requires a “database” not just memory.

Accordingly, we determine that Petitioner has failed to show that Väänänen teaches or suggests the claim 1 limitation of a “message database storing the instant voice message.”

b. Claims 1 and 6 – motivation to combine
Väänänen’s and Holtzberg’s teachings

Petitioner argues that to the extent Väänänen does not teach or suggest the required database, “storing voice messages in a database was well-known in the prior art, e.g., as explicitly taught in Holtzberg.” *Id.* The reasons for the motivation to combine are the same as those proffered for the Abburi grounds discussed above. Pet. 50, 60. For instance, Petitioner

alleges that Väänänen would be improved by implementing the “database storage techniques of Holtzberg for audio messages.” *Id.* at 50. Petitioner also argues that incorporating Holtzberg’s database structure into Väänänen amounts to “nothing more than applying a known technique (e.g., storing voice messages in a database) to a known device (e.g., subscriber terminal 500) ready for improvement to yield predictable results (a subscriber terminal storing audio messages in a database).” *Id.* at 60 (citing Ex. 1003 ¶ 174). Finally, Petitioner asserts that a person of ordinary skill in the art would have been motivated to “improve the organization and retrieval of audio messages stored on a user’s device (e.g., subscriber terminal 500).” *Id.* (citing Ex. 1003 ¶ 175).

Patent Owner challenges the proffered reasons stating that the proposed modification based on Holtzberg fails for analogous reasons to those presented for the Abburi grounds. PO Resp. 29 (citing Ex. 2001 ¶¶ 57–58). We agree that the reasons Petitioner asserts for the combination of Väänänen and Holtzberg are deficient for similar reasons as stated above with regard to the Abburi grounds. For instance, the *KSR* statement of applying a known technique to a known device to yield predictable results offers insufficient explanation and factual support to be entitled to weight in the circumstances of this case. 37 C.F.R. § 42.65(a) (“Expert testimony that does not disclose the underlying facts or data on which the opinion is based is entitled to little or no weight.”).

Most notably, the record lacks persuasive explanation of *why* and *how* a person of ordinary skill in the art would incorporate the centralized voicemail database of Holtzberg into Väänänen’s subscriber terminal. As stated above, Väänänen does not contemplate a subscriber terminal that

stores *generated and transmitted* instant voice messages. At best, as Petitioner points out, Väänänen teaches that the received voice message may be stored in the memory of the subscriber terminal after reassembling the packet data stream into a data file. Ex. 1006, 6:28–42. Väänänen does not teach, however, the use of a database at the subscriber terminal. Rather, Väänänen is explicit in describing a database only at the server. Ex. 1006, 11:40–42. Nevertheless, without explaining the modification to Väänänen’s RAM or subscriber terminal storage to accommodate a database, which Väänänen only describes with respect to the server, Petitioner alleges an unexplained incorporation of Holtzberg’s voicemail database into the subscriber terminals of Väänänen. Petitioner does not explain *how* Väänänen’s subscriber terminals would have been modified to accommodate a voicemail database that, as explained above with respect to the Abburi grounds, is designed for centralized storage of voicemail for all of Holtzberg’s system users. Petitioner also does not explain *why* (or *how*) decentralizing Holtzberg’s voicemail database would be desirable in Väänänen’s system where the only disclosed database is located at the server. As already stated, the assertion of “improved organization and retrieval” is a *generic* benefit that may be derived from the general use of a database, but does not provide reason for modifying Väänänen’s subscriber terminals specifically to incorporate an otherwise centralized database into each subscriber terminal of the system.

As with the Abburi grounds, the record lacks the specificity of facts to support the asserted combination of Väänänen and Holtzberg as asserted in the Petition. *See Nuvasive*, 842 F.3d at 1381–82. A determination of obviousness cannot be reached where the record lacks “explanation as to

how or why the references would be combined to produce the claimed invention.” *Trivascular*, 812 F.3d at 1066; *see Nuvasive*, 842 F.3d at 1382–85; *Magnum Oil*, 829 F.3d at 1380–81. In Reply, Petitioner relies on the same arguments and evidence proffered with respect to the Abburi/Holtzberg combination, discussed above. Reply 20. Especially with respect to the additional rationales included in the Reply, we have previously addressed Petitioner’s reply arguments and need not repeat that analysis here.

Accordingly, we determine that Petitioner has failed to show obviousness of independent claims 1 and 6 based on Väänänen and Holtzberg. None of the remaining references in the Väänänen-based grounds is alleged to cure the deficiencies noted above. Consequently, we conclude that Petitioner has failed to show obviousness of all challenged claims under the Väänänen-based grounds.

III. CONCLUSION

We have reviewed the arguments and evidence of record presented by the parties. We conclude that Petitioner *has not shown* by a preponderance of the evidence that independent claims 1 and 6 would have been obvious over either the combination of Abburi and Holtzberg or the combination of Väänänen and Holtzberg. The remaining challenged claims depend directly or indirectly from claim 1. Consequently, we determine that Petitioner has failed to demonstrate by a preponderance of the evidence that any of the challenged claims are unpatentable.

IV. ORDER

In consideration of the foregoing, it is hereby:

ORDERED that claims 1–6 and 8 of the ’433 patent have not been

IPR2017-00225
Patent 8,995,433 B2

shown to be unpatentable; and

FURTHER ORDERED that, because this is a Final Written Decision, parties to the proceeding seeking judicial review of the decision must comply with the notice and service requirements of 37 C.F.R. § 90.2.

IPR2017-00225
Patent 8,995,433 B2

For PETITIONER:

Apple Inc.

Jason D. Eisenberg

Michael D. Specht

Steven Pappas

STERNE, KESSLER, GOLDSTEIN & FOX P.L.L.C.

jasone-ptab@skgf.com

mspecht-ptab@skgf.com

spappas-ptab@skgf.com

Snap Inc., Facebook, Inc. and WhatsApp, Inc.

Heidi L. Keefe

Phillip Morton

Lisa F. Schwier

COOLEY LLP

hkeefe@cooley.com

pmorton@cooley.com

lschwier@cooley.com

For PATENT OWNER:

Brett Mangrum

Ryan Loveless

ETHERIDGE LAW GROUP

brett@etheridgelaw.com

ryan@etheridgelaw.com

Sean D. Burdick

UNILOC USA, INC.

sean.burdick@unilocusa.com