

47157 U.S. PTO  
121103

Under the Paperwork Reduction Act of 1995, no persons are required to respond to a collection of information unless it displays a valid OMB control number.

<b>UTILITY PATENT APPLICATION TRANSMITTAL</b>		Attorney Docket No.	3358.2.1
		First Inventor	Lyman O. Nielson
		Title	LOW-VOLTAGE LIGHTING APPARATUS FOR SATISFYING AFTER-HOURS LIGHTING REQUIREMENTS, EMERGENCY LIGHTING REQUIREMENTS, AND LOW LIGHT REQUIREMENTS
(Only for new nonprovisional applications under 37 C.F.R. 1.53(b))		Express Mail Label No.	EV343632609US

<p style="text-align: center;"><b>APPLICATION ELEMENTS</b></p> <p>See MPEP chapter 600 concerning utility patent application contents.</p> <p>1. <input type="checkbox"/> Fee Transmittal Form (e.g., PTO/SB/17) <i>(Submit an original and a duplicate for fee processing)</i></p> <p>2. <input checked="" type="checkbox"/> Applicant claims small entity status. See 37 CFR 1.27.</p> <p>3. <input checked="" type="checkbox"/> Specification [Total Pages <input type="text" value="22"/> ] <i>(preferred arrangement set forth below)</i></p> <ul style="list-style-type: none"> <li>- Descriptive title of the Invention</li> <li>- Cross Reference to Related Applications</li> <li>- Statement Regarding Fed sponsored R &amp; D</li> <li>- Reference to sequence listing, a table, or a computer program listing appendix</li> <li>- Background of the Invention</li> <li>- Brief Summary of the Invention</li> <li>- Brief Description of the Drawings (if filed)</li> <li>- Detailed Description</li> <li>- Claim(s)</li> <li>- Abstract of the Disclosure</li> </ul> <p>4. <input checked="" type="checkbox"/> Drawing(s) (35 U.S.C. 113) [Total Sheets <input type="text" value="5"/> ]</p> <p>5. Oath or Declaration [Total Pages <input type="text"/> ]</p> <p>a. <input type="checkbox"/> Newly executed (original or copy)</p> <p>b. <input type="checkbox"/> Copy from a prior application (37 CFR 1.63 (d)) <i>(for a continuation/divisional with Box 18 completed)</i></p> <p>i. <input type="checkbox"/> <b>DELETION OF INVENTOR(S)</b> Signed statement attached deleting inventor(s) named in the prior application, see 37 CFR 1.63(d)(2) and 1.33(b).</p> <p>6. <input type="checkbox"/> Application Data Sheet. See 37 CFR 1.76</p>	<p style="text-align: center;"><b>ADDRESS TO:</b></p> <p>Mail Stop Patent Application Commissioner for Patents P.O. Box 1450 Alexandria, VA 22313-1450</p> <p>7. <input type="checkbox"/> CD-ROM or CD-R in duplicate, large table or Computer Program <i>(Appendix)</i></p> <p>8. Nucleotide and/or Amino Acid Sequence Submission <i>(if applicable, all necessary)</i></p> <p>a. <input type="checkbox"/> Computer Readable Form (CRF)</p> <p>b. Specification Sequence Listing on:</p> <p>i. <input type="checkbox"/> CD-ROM or CD-R (2 copies); or</p> <p>ii. <input type="checkbox"/> paper</p> <p>c. <input type="checkbox"/> Statements verifying identity of above copies</p> <p style="text-align: center;"><b>ACCOMPANYING APPLICATIONS PARTS</b></p> <p>9. <input type="checkbox"/> Assignment Papers (cover sheet &amp; document(s))</p> <p>10. <input type="checkbox"/> 37 C.F.R. §3.73(b) Statement <input type="checkbox"/> Power of Attorney <i>(when there is an assignee)</i></p> <p>11. <input type="checkbox"/> English Translation Document <i>(if applicable)</i></p> <p>12. <input type="checkbox"/> Information Disclosure Statement (IDS)/PTO-1449 <input type="checkbox"/> Copies of IDS Citations</p> <p>13. <input type="checkbox"/> Preliminary Amendment</p> <p>14. <input checked="" type="checkbox"/> Return Receipt Postcard (MPEP 503) <i>(Should be specifically itemized)</i></p> <p>15. <input type="checkbox"/> Certified Copy of Priority Document(s) <i>(if foreign priority is claimed)</i></p> <p>16. <input type="checkbox"/> Nonpublication Request under 35 U.S.C. 122 (b)(2)(B)(i). Applicant must attach form PTO/SB/35 or its equivalent.</p> <p>17. <input checked="" type="checkbox"/> Other: <u>Express Mail Certificate</u></p>
--	--

18. If a CONTINUING APPLICATION, check appropriate box, and supply the requisite information below and in a preliminary amendment, or in an Application Data Sheet under 37 CFR 1.76:

Continuation     Divisional     Continuation-in-part (CIP)    of prior application No: \_\_\_ /

Prior application information:    Examiner: \_\_\_    Group / Art Unit: \_\_\_

**For CONTINUATION or DIVISIONAL APPS only:** The entire disclosure of the prior application, from which an oath or declaration is supplied under Box 5b, is considered a part of the disclosure of the accompanying or divisional application and is hereby incorporated by reference. The incorporation can only be relied upon when a portion has been inadvertently omitted from the submitted application parts.

**19. CORRESPONDENCE ADDRESS**

Customer Number  or  Correspondence address below

Name			
Address			
City	State	Zip Code	
Country	Telephone	Fax	

Name (Print/Type)	Craig J. Madson	Registration No. (Attorney/Agent)	29,407
Signature		Date	12/11/2003

This collection of information is required by 37 CFR 1.53(b). The information is required to obtain or retain a benefit by the public which is to file (and by the USPTO to process) an application. Confidentiality is governed by 35 U.S.C. 122 and 37 CFR 1.14. This collection is estimated to take 12 minutes to complete, including gathering, preparing, and submitting the completed application form to the USPTO. Time will vary depending upon the individual case. Any comments on the amount of time you are required to complete this form and/or suggestions for reducing this burden, should be sent to the Chief Information Officer, U.S. Patent and Trademark Office, U.S. Department of Commerce, P.O. Box 1450, Alexandria, VA 22313-1450. DO NOT SEND FEES OR COMPLETED FORMS TO THIS ADDRESS. SEND TO: Mail Stop Patent Application, Commissioner for Patents, P.O. Box 1450, Alexandria, VA 22313-1450.

If you need assistance in completing this form, call 1-800-PTO-9199 and selection option 2.

CERTIFICATE OF MAILING BY "EXPRESS MAIL"

"Express Mail" Mailing Label No.: EV343632609US

Date of Deposit: December 11, 2003

I hereby certify that this patent application in the name of Lyman O. Nielson et al. for LOW-VOLTAGE LIGHTING APPARATUS FOR SATISFYING AFTER-HOURS LIGHTING REQUIREMENTS, EMERGENCY LIGHTING REQUIREMENTS, AND LOW LIGHT REQUIREMENTS, together with drawings are being deposited with the United States Postal Service "Express Mail Post Office to Addressee" service under 37 C.F.R. § 1.10 on the date indicated above in an envelope addressed to Mail Stop Patent Application, Commissioner for Patents, P.O. Box 1450, Alexandria, VA 22313-1450.

Respectfully submitted,

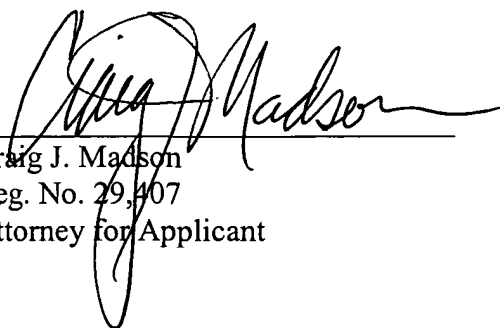

Craig J. Madson  
Reg. No. 29,407  
Attorney for Applicant

Date: December 11, 2003

MADSON & METCALF  
Gateway Tower West  
15 West South Temple, Suite 900  
Salt Lake City, Utah 84101  
Telephone: 801/537-1700

Express Mailing Label No. EV343632609US

PATENT APPLICATION  
Docket No. 3358.2.1

**UNITED STATES PATENT APPLICATION**

**of**

**LYMAN O. NIELSON**

**and**

**NORMAN B. HESS**

**for**

**LOW-VOLTAGE LIGHTING APPARATUS FOR SATISFYING AFTER-  
HOURS LIGHTING REQUIREMENTS, EMERGENCY LIGHTING  
REQUIREMENTS, AND LOW LIGHT REQUIREMENTS**

# LOW-VOLTAGE LIGHTING APPARATUS FOR SATISFYING AFTER-HOURS LIGHTING REQUIREMENTS, EMERGENCY LIGHTING REQUIREMENTS, AND LOW LIGHT REQUIREMENTS

## RELATED APPLICATIONS

[01] This application is related to and claims priority from U.S. Patent Application Serial No. 60/432,562, filed December 11, 2002, for "Low-Voltage Lighting Apparatus," with inventors Lyman O. Nielson and Norman B. Hess, which is incorporated herein by reference.

## TECHNICAL FIELD

[02] The present invention relates generally to lighting apparatus for use in buildings. More specifically, the present invention relates to lighting apparatus that provide sufficient illumination to satisfy after-hours lighting requirements, emergency lighting requirements, and low light requirements.

## BACKGROUND

[03] There are many types of light fixtures. Light fixtures may utilize incandescent lamps, fluorescent lamps, metal halide lamps, and others. One of the most widely used light fixtures for large buildings, stores, warehouses, manufacturing facilities, and the like is the fluorescent light fixture. Fluorescent light fixtures are efficient to operate and are capable of illuminating relatively large areas.

[04] A typical fluorescent light fixture has an elongated housing, usually made of metal or plastic with a downwardly opening elongated cavity in which is carried one or more tubular fluorescent lamps for emitting light below the fixture. The central element in a fluorescent lamp is a sealed glass tube. The tube contains a small amount of mercury and an inert gas, typically argon, kept under very low pressure. The tube also contains a phosphor powder. The phosphor powder is coated along the inside of the glass tube. The tube has two electrodes, one at each end, which are wired to an electrical circuit. The electrical circuit is connected to an alternating current (AC) source. When a fluorescent lamp is turned on, the current flows through the

electrical circuit to the electrodes. The current stimulates the mercury atoms, causing them to release ultraviolet photons. These photons in turn stimulate the phosphor, which emits visible light photons.

[05] In most commercial buildings, it is not necessary to keep all of the light fixtures illuminated after normal business hours. Indeed, it is generally desirable to keep after-hours lighting to the minimum necessary for maintenance and security personnel to be able to effectively perform their duties. Presently, this is accomplished by turning on only a few of the available light fixtures.

[06] Emergency lighting is utilized in most buildings to provide light for egress and to direct occupants toward the exits in case of a loss of main power to a building. This is generally accomplished by installing exit and emergency lighting fixtures at various locations, such as corridors, stairwells, ramps, escalators, aisles, exit passageways, and the like. The exit and emergency lighting fixtures are generally self-contained and may utilize small batteries which are kept charged in case of main power failure.

[07] In some situations, it is desirable to have only a minimal amount of light within a room. For example, when a person is giving a presentation that includes the display of pictures and/or video, it is typically desirable for the room to be somewhat dim but not completely dark. As another example, some individuals like to reduce the amount of light within their office when they are working on a computer, in order to maximize the contrast between their computer monitor and the surrounding area. There are numerous other examples of situations where it may be desirable for the light fixtures in a particular area to be able to satisfy low light requirements, i.e., to provide only a minimal amount of light.

[08] In view of the foregoing, benefits may be realized by improved light fixtures that are capable of satisfying after-hours lighting requirements more efficiently and conveniently than presently known light fixtures. Additional benefits may be realized if such improved light fixtures were also capable of providing emergency lighting in situations where power to a building has been lost. Yet additional benefits may be realized if such improved light fixtures were also capable of satisfying low light requirements.

### **SUMMARY OF THE INVENTION**

[09] An energy-efficient lighting apparatus is disclosed. The lighting apparatus includes a ballast cover. The ballast cover includes a plurality of ballast cover holes. The lighting apparatus also includes a circuit board comprising a plurality of light-emitting diodes. The circuit board is positioned adjacent the ballast cover so that the plurality of light-emitting diodes protrude through the plurality of ballast cover holes in the ballast cover. The lighting apparatus may also include a battery for supplying power to the plurality of light-emitting diodes.

[10] The lighting apparatus may also include a switching circuit for controlling illumination of the plurality of light-emitting diodes. The switching circuit may include a first portion for placing the switching circuit in communication with a wall switch. The switching circuit may also include a second portion for coupling the switching circuit to the battery. The switching circuit may also include a third portion for coupling the switching circuit to the plurality of light-emitting diodes.

[11] In some embodiments, the switching circuit couples the battery to the plurality of light-emitting diodes if the switching circuit is not receiving AC voltage from an AC voltage source that is coupled to the wall switch. The switching circuit does not couple the battery to the plurality of light-emitting diodes if the switching circuit is receiving the AC voltage from the AC voltage source.

[12] Alternatively, the switching circuit may additionally include a fourth portion for receiving an alarm signal from an alarm device. The switching circuit couples the battery to the plurality of light-emitting diodes if the switching circuit is receiving the alarm signal.

[13] The lighting apparatus may also include a battery charging circuit for charging the battery. The battery charging circuit may include a first portion for coupling the battery charging circuit to an AC voltage source. The battery charging circuit may also include a second portion for coupling the battery charging circuit to the battery.

[14] In some embodiments, the circuit board additionally includes a battery test light coupled to the battery. The battery test light may protrude through one of the plurality of ballast cover holes.

[15] An energy-efficient lighting apparatus for retrofit with an existing light fixture having a ballast cover is also disclosed. The lighting apparatus includes a housing having an attachment surface and an illumination surface. The illumination surface includes a plurality of illumination surface holes. The lighting apparatus also includes a circuit board comprising a plurality of light-emitting diodes. The circuit board is positioned adjacent the housing so that the plurality of light-emitting diodes protrude through the plurality of illumination surface holes in the illumination surface. The lighting apparatus also includes a fastening mechanism for securing the attachment surface of the lighting apparatus to the ballast cover.

[16] The lighting apparatus may also include a connector in the attachment surface of the housing that snaps into a ballast cover hole in the ballast cover. Wires may be provided for connecting the circuit board to the battery through the connector. In some embodiments, the fastening mechanism may include an adhesive strip having a protective cover.

[17] A method for providing illumination to an area in an energy-efficient manner is also disclosed. The method involves providing a ballast cover. The ballast cover is attachable to a light fixture. The ballast cover has a plurality of ballast cover holes. The method also involves providing a circuit board that includes a plurality of light-emitting diodes. The method additionally involves positioning the circuit board adjacent the ballast cover so that the plurality of light-emitting diodes protrude through the plurality of ballast cover holes in the ballast cover.

[18] In some embodiments, the method additionally involves illuminating the plurality of light-emitting diodes when a light bulb within the light fixture is not illuminated. Alternatively, the method may involve not illuminating the plurality of light-emitting diodes when the light bulb within the light fixture is illuminated. Alternatively still, the method may involve receiving an alarm signal from an alarm device, and, in response to receiving the alarm signal, illuminating the plurality of light-emitting diodes.

[19] A method for retrofitting a light fixture with an energy-efficient lighting apparatus is also disclosed. The light fixture includes a ballast cover. The method involves providing a housing having an attachment surface and an illumination surface. The illumination surface includes a plurality of illumination surface holes. The method also involves providing a circuit board comprising a plurality of light-emitting diodes. The method also involves positioning the circuit

board adjacent the housing so that the plurality of light-emitting diodes protrude through the plurality of illumination surface holes in the illumination surface. The method also involves securing the attachment surface of the housing to the ballast cover.



**BRIEF DESCRIPTION OF THE DRAWINGS**

[20] The present embodiments will become more fully apparent from the following description and appended claims, taken in conjunction with the accompanying drawings. Understanding that these drawings depict only typical embodiments and are, therefore, not to be considered limiting of the invention's scope, the embodiments will be described with additional specificity and detail through use of the accompanying drawings in which:

[21] Figure 1 is a top plan view of an embodiment of a lighting apparatus that provides sufficient illumination to satisfy after-hours lighting requirements, emergency lighting requirements, and low light requirements;

[22] Figure 2 is a side plan view of the plurality of light-emitting diodes in the lighting apparatus of Figure 1 coupled to a circuit board;

[23] Figure 3 is a block diagram illustrating various components in an embodiment of the lighting apparatus as well as several additional components that are used with the lighting apparatus in typical operation;

[24] Figure 4 is a block diagram illustrating various components in another embodiment of the lighting apparatus as well as several additional components that are used with the lighting apparatus in typical operation;

[25] Figure 5 is a side plan view of another embodiment of a lighting apparatus; and

[26] Figure 6 is a top plan view of the embodiment of the lighting apparatus shown in Figure 5.

## **DETAILED DESCRIPTION**

[27] Various embodiments of the invention are now described with reference to the Figures, where like reference numbers indicate identical or functionally similar elements. It will be readily understood that the components of the present invention, as generally described and illustrated in the Figures herein, could be arranged and designed in a wide variety of different configurations. Thus, the following more detailed description of several exemplary embodiments of the present invention, as represented in the Figures, is not intended to limit the scope of the invention, as claimed, but is merely representative of the embodiments of the invention.

[28] The word “exemplary” is used exclusively herein to mean “serving as an example, instance, or illustration.” Any embodiment described herein as “exemplary” is not necessarily to be construed as preferred or advantageous over other embodiments. While the various aspects of the embodiments are presented in drawings, the drawings are not necessarily drawn to scale unless specifically indicated.

[29] Figure 1 is a top plan view of an embodiment of a lighting apparatus 100 installed in a light fixture housing 101. In the illustrated embodiment, the lighting apparatus 110 includes a ballast cover 110. The ballast cover 110 includes a plurality of notches 115 that hold the ballast cover 110 in place within the light fixture housing 101. The lighting apparatus 100 also includes a plurality of light-emitting diodes (LEDs) 104, which protrude through holes in the ballast cover 110.

[30] In addition to the lighting apparatus 100, a pair of fluorescent lights 102 are also installed in the light fixture housing 101. As shown in Figure 1, when the lighting apparatus 100 and the fluorescent lights 102 are installed in the light fixture housing 101, the fluorescent lights 102 and the LEDs 104 are visible when looking at the finished side of the light fixture housing 101.

[31] The fluorescent lights 102 and the LEDs 104 may be turned on at different times to accomplish different purposes. For example, the fluorescent lights 102 may be turned on in a building during normal business hours. The LEDs 104 may be turned on at night to satisfy after-hours lighting requirements. The LEDs 104 may also be turned on to provide emergency lighting when power to a building has been lost. The LEDs 104 may also be turned on at various times to satisfy low light requirements.

[32] The use of LEDs 104 to satisfy after-hours lighting requirements, emergency lighting requirements, and/or low light requirements may result in significant power savings. Typically, LEDs 104 consume significantly less power than fluorescent lights 102. For example, the power consumption of an average fluorescent light bulb 102 is 77-96 watts. In contrast, the power consumption of 80 LEDs 104 is only approximately 8 watts.

[33] Power is supplied to the fluorescent lights 102 from an AC source by means of a ballast (not shown). The ballast cover 110 covers the primary wiring to the fixture 101, including the ballast. In some contexts, the ballast cover 110 may be referred to as a raceway cover. The ballast is coupled to an AC voltage source by means of a wall switch (not shown), i.e., a switch that is mounted to a wall within a room where the light fixture housing 101 is installed. The wall switch is accessible to individuals within the room, and allows individuals to turn the fluorescent lights 102 on and off. When the wall switch is in a closed position, the AC voltage source supplies AC voltage to the ballast. The ballast maintains a desired current through the fluorescent lights 102 so that the fluorescent lights 102 are illuminated. When the wall switch is in an open position, the AC voltage source does not supply AC voltage to the ballast. Consequently, the ballast does not maintain any current through the fluorescent lights 102, and the fluorescent lights 102 are not illuminated.

[34] Figure 2 is a side plan view of the plurality of light-emitting diodes 104 in the lighting apparatus 100 of Figure 1 coupled to a circuit board 211. The circuit board 211 holds the LEDs 104 in place. The circuit board 211 is shown without the ballast cover 110 in Figure 2. However, at some point during installation of the lighting apparatus 100, the circuit board 211 is positioned adjacent the ballast cover 110 so that the LEDs 104 protrude through holes in the ballast cover 110. In some embodiments, the circuit board 211 may be secured to the ballast cover 110. As used herein, the term “secured” includes but does not require direct contact. That is, the circuit board 211 may be directly touching the ballast cover 110. Alternatively, the circuit board 211 may not be directly touching the ballast cover 110. When the lighting apparatus 100 is installed in a light fixture housing 101, the circuit board 211 is part of the ballast compartment, or raceway.

[35] The lighting apparatus 100 includes a battery 212 for supplying DC voltage to the LEDs 104. The lighting apparatus 100 may also include circuitry 213 for accomplishing various functionality. The battery 212 and the circuitry 213 are coupled to the circuit board 211. Connectors may be used to couple the battery 212 and the circuitry 213 to the circuit board 211. In alternative embodiments, wires may be used.

[36] The circuitry 213 may include a switching circuit that controls when DC voltage from the battery 212 is supplied to the LEDs 104. The circuitry 213 may also include a battery charging circuit that charges the battery 212. The switching circuit and the battery charging circuit are not specifically shown in Figure 2. However, these circuits will be discussed below.

[37] The embodiment of the lighting apparatus 100 shown in Figures 1-2 and discussed in connection therewith may be used to replace existing ballast covers. Alternatively, or in addition, the lighting apparatus 100 may be used in new installations of light fixtures.

[38] Figure 3 is a block diagram illustrating various components in an embodiment of the lighting apparatus 300. Figure 3 also illustrates several components that are used with the lighting apparatus 300 in typical operation.

[39] The components that are used with the lighting apparatus 300 include a wall switch 316, an AC voltage source 318, and a ballast 320. The wall switch 316 couples the AC voltage source 318 to the ballast 320. As discussed above, when the wall switch 316 is in the closed position, the AC voltage source 318 supplies AC voltage to the ballast 320. The ballast 320 maintains a desired current through the fluorescent lights 102, so that the fluorescent lights 102 are illuminated. When the wall switch is in the open position, the AC voltage source does not supply AC voltage to the ballast 320, and the fluorescent lights 102 are not illuminated.

[40] The lighting apparatus 300 includes a switching circuit 322. In general terms, the switching circuit 322 performs the function of controlling the illumination of the LEDs 304. More specifically, the switching circuit 322 couples the battery 312 to the LEDs 304 under some circumstances. However, under other circumstances, the switching circuit 322 does not couple the battery 312 to the LEDs 304. If the battery 312 is coupled to the LEDs 304, DC voltage from the battery 312 is provided to the LEDs 304, and the LEDs 304 are illuminated. If the battery

312 is not coupled to the LEDs 304, DC voltage from the battery 312 is not provided to the LEDs 304, and the LEDs 304 are not illuminated.

[41] The switching circuit 322 is in communication with the wall switch 316. In some embodiments, the switching circuit 322 is directly coupled to the wall switch 316. In other embodiments, the switching circuit 322 is not directly coupled to the wall switch 316, but is in electronic communication with the wall switch 316. For example, the wall switch 316 and the switching circuit 322 may communicate via a wireless protocol. In typical operation, the wall switch 316 controls the behavior of the switching circuit 322. For example, in some embodiments if the wall switch 316 is in a first position, the switching circuit 322 couples the battery 312 to the LEDs 304. If the wall switch 316 is in a second position, the switching circuit 322 does not couple the battery 312 to the LEDs 304. As discussed above, the wall switch 316 is typically operated by individuals in the room where the lighting apparatus 300 is installed.

[42] In the illustrated embodiment, the switching circuit 322 couples the battery 312 to the LEDs 304 whenever the switching circuit 322 is not receiving AC voltage from the AC voltage source 318. Conversely, the switching circuit 322 does not couple the battery 312 to the LEDs 304 whenever the switching circuit 322 is receiving AC voltage from the AC voltage source 318. Those skilled in the art will recognize that there are numerous ways to implement a switching circuit 322 that performs the described functions. In some embodiments, the switching circuit 322 may include one or more relays.

[43] In the illustrated embodiment, the switching circuit 322 is coupled to the AC voltage source 318 via the wall switch 316. Consequently, the switching circuit 322 receives AC voltage from the AC voltage source 318 if two conditions are satisfied: first, the AC voltage source 318 is supplying AC voltage; and second, the wall switch 316 is in the closed position. Conversely, the switching circuit 322 does not receive AC voltage from the AC voltage source 318 if the wall switch 316 is in the open position. The switching circuit 322 also does not receive AC voltage from the AC voltage source 318 if the AC voltage source 318 is not supplying AC voltage (i.e., if power to the building has been lost).

[44] One implication of the switching circuit 322 configuration discussed above is that as long as the battery 312 is supplying DC voltage, the LEDs 304 are illuminated whenever the

fluorescent lights 102 are turned off. To see why, note that the fluorescent lights 102 are turned off when the wall switch 316 is in the open position. When the wall switch 316 is in the open position, AC voltage from the AC voltage source 318 is not supplied to the switching circuit 322. Because the switching circuit 322 is not receiving AC voltage, the switching circuit 322 couples the battery 312 to the LEDs 304. Consequently, DC voltage from the battery 312 is provided to the LEDs 304 and the LEDs 304 are illuminated.

[45] Another implication of the switching circuit 322 configuration discussed above is that the LEDs 304 are not illuminated when the fluorescent lights 102 are turned on. To see why, note that the fluorescent lights 102 are turned on when the wall switch 316 is in the closed position. When the wall switch 316 is in the closed position, AC voltage from the AC voltage source 318 is supplied to the switching circuit 322. Because the switching circuit 322 is receiving AC voltage, the switching circuit 322 does not couple the battery 312 to the LEDs 304. Consequently, the battery 312 is not coupled to the LEDs 304, and DC voltage from the battery 312 is not provided to the LEDs 304. The LEDs 304, therefore, are not illuminated.

[46] Yet another implication of the switching circuit 322 configuration discussed above is that as long as the battery 312 is supplying DC voltage, the LEDs 304 are illuminated whenever the AC voltage source 318 is not supplying AC voltage (i.e., when power is lost). To see why, note that if the AC voltage source 318 is not supplying AC voltage, the switching circuit 322 is not receiving AC voltage. Because the switching circuit 322 is not receiving AC voltage, the switching circuit 322 couples the battery 312 to the LEDs 304. Consequently, DC voltage from the battery 312 is provided to the LEDs 304 and the LEDs 304 are illuminated.

[47] Another component of the lighting apparatus 300 that is shown in Figure 3 is a battery charging circuit 324. The battery charging circuit 324 is coupled to the battery 312 and performs the function of charging the battery 312. In the illustrated embodiment, the battery charging circuit 324 is coupled to the AC voltage source 318. As long as the AC voltage source 318 is supplying AC voltage, the battery charging circuit 324 is charging the battery 312. Those skilled in the art will recognize that there are numerous ways to implement a battery charging circuit 324 that performs the described functions.

[48] Advantageously, the battery charging circuit 324 allows the battery 312 to be charging even while the battery 312 is supplying DC voltage to the LEDs 304. This is because the battery charging circuit 324 is coupled directly to the AC voltage source 318, not to the wall switch 316. Thus, even when the wall switch 316 is in the open position (which, as discussed above, causes the LEDs 304 to be illuminated), AC voltage is being supplied to the battery charging circuit 324. Consequently, illuminating the LEDs 304 generally does not drain the battery 312. Another advantage of the battery charging circuit 324 is that the battery 312 is ordinarily fully charged when an emergency situation occurs and power to a building is lost.

[49] In some embodiments, a separate battery 312 and battery charging circuit 324 may be provided for each lighting apparatus 300. In such embodiments, if something causes the battery 312 within a particular lighting apparatus 300 to stop supplying DC voltage, only that lighting apparatus 300 is affected. This might be advantageous where more than one lighting apparatus 300 is installed in the same building, particularly if the lighting apparatus 300 are used to provide emergency lighting. In contrast, in some known emergency lighting systems all of the emergency lights within the building are all dependent on the same battery. In those systems, if the battery stops functioning, this causes all of the emergency lights in the building to stop functioning.

[50] As described above, the LEDs 304 are generally coupled to and held in place by a circuit board (not shown) that is positioned adjacent the ballast cover 110. In some embodiments, the battery 312, the switching circuit 322, and the battery charging circuit 324 may be coupled to the circuit board by means of connectors. Advantageously, this eliminates the necessity of connecting the different components by means of wires. Of course, in some embodiments the different components may be connected by means of wires.

[51] The configuration shown in Figure 3 is exemplary only. In some embodiments, the battery 312 may be coupled to the LEDs 304 at all times. In this configuration, the LEDs 304 would always be on, regardless of whether the fluorescent lights 102 are turned on or not.

[52] In some embodiments, a strobe effect may be used to sequence light emitted from the LEDs 304 to direct people to an exit in an emergency situation. This may be done with the white LEDs 304. Alternatively, another color may be used, such as green lights.

[53] Figure 4 is a block diagram illustrating various components in another embodiment of the lighting apparatus 400. Figure 4 also illustrates several components that are used with the lighting apparatus 400 in typical operation. The embodiment of the lighting apparatus 400 shown in Figure 4 is similar in many respects to the embodiment of the lighting apparatus 300 shown in Figure 3 and described in connection therewith. Those components of the lighting apparatus 400 that are similar to components in the lighting apparatus 300 shown in Figure 3 are labeled with corresponding reference numbers. For example, the wall switch 416 corresponds to the wall switch 316 in Figure 3, the ballast 420 corresponds to the ballast 320 in Figure 3, and the battery charging circuit 424 corresponds to the battery charging circuit 324 in Figure 3. These components will not be discussed again in connection with Figure 4.

[54] In the illustrated embodiment, the switching circuit 422 is in electronic communication with an alarm device 426. Some examples of alarm devices 426 include a fire alarm, a smoke alarm, etc. The alarm device 426 generates an alarm signal under certain circumstances, typically in an emergency situation. The switching circuit 422 is configured to receive the alarm signal from the alarm device 426. In some embodiments, the electronic communication between the alarm device 426 and the switching circuit 422 is wireless. For example, the alarm signal may be a radio signal, and the switching circuit 422 may include an antenna for receiving the radio signal. In other embodiments, the switching circuit 422 may be electronically coupled to the alarm device 426 by means of wires or other physical connectors.

[55] The switching circuit 422 shown in Figure 4 couples the battery 412 to the LEDs 404 when either of two conditions occur. First, as before, the switching circuit 422 couples the battery 412 to the LEDs 404 when the switching circuit 422 is not receiving AC voltage from the AC voltage source 418. Second, the switching circuit 422 couples the battery 412 to the LEDs 404 when the switching circuit 422 receives an alarm signal from the alarm device 426. The switching circuit 422 does not couple the battery 412 to the LEDs 404 if the switching circuit 422 is receiving AC voltage from the AC voltage source 418, unless the switching circuit 422 receives an alarm signal from the alarm device 426.

[56] One implication of the switching circuit 422 configuration shown in Figure 4 is that the LEDs 404 may be illuminated when the fluorescent lights 102 are turned on. Specifically, if the



switching circuit 422 receives an alarm signal from the alarm device 426 when the fluorescent lights 102 are turned on, the switching circuit 422 couples the battery 412 to the LEDs 404 so that the LEDs 404 are also illuminated. Such a configuration may be advantageous if an emergency situation occurs (e.g., a fire) when the fluorescent lights 102 are illuminated. In such a situation, the LEDs 404 would also be illuminated to provide additional emergency lighting.

[57] Figure 5 is a side plan view of another embodiment of a lighting apparatus 500. As will be described in greater detail below, the lighting apparatus 500 illustrated in Figure 5 may easily and inexpensively be secured to existing light fixtures. Thus, existing light fixtures may be retrofit with the lighting apparatus 500 in order to achieve the energy savings described above without incurring significant expense. In the illustrated embodiment, the lighting apparatus 500 is configured to be secured to the ballast cover (not shown) within a light fixture.

[58] The lighting apparatus 500 includes a housing 528. In some embodiments, the housing 528 is made of plastic, although the housing 528 may be made of other materials. The housing 528 is dimensioned so that it may be installed to an existing ballast cover. The housing 528 includes an attachment surface 530 and an illumination surface 532. In typical operation, the attachment surface 530 is secured to the ballast cover. The illumination surface 532 is opposite the attachment surface 530. As used herein, the terms "securing" and "secured" do not require direct contact. In other words, the attachment surface 530 of the housing 528 may be directly touching the ballast cover. Alternatively, the attachment surface 530 of the housing 528 may not be directly touching the ballast cover.

[59] A section of the housing 528 is illustrated as being cut away from the housing 528 shown in Figure 5 in order to expose a circuit board 511. As before, the lighting apparatus 500 includes a plurality of LEDs 504. The LEDs 504 are coupled to the circuit board 511. The circuit board 511 holds the LEDs 504 in place. The circuit board 511 is positioned adjacent the housing 528 so that the LEDs 504 protrude through a plurality of holes in the illumination surface 532 of the housing 528. The circuit board 511 may be positioned either partially or wholly inside the housing 528.

[60] The attachment surface 530 of the housing 528 includes a fastening mechanism 534. The fastening mechanism 534 performs the function of securing the attachment surface 530 of the

housing 528 to the ballast cover. In the illustrated embodiment, the fastening mechanism 534 is an adhesive strip 534 having a protective cover. The protective cover may be easily removed to expose the adhesive strip 534. One side of the adhesive strip 534 may be attached to the attachment surface 530 of the housing 528. The other side of the adhesive strip 534 may be attached to the ballast cover (not shown) to which the lighting apparatus 500 is to be installed. Of course, in alternative embodiments many different types of fastening mechanisms 534 may be used. For example, in some embodiments the fastening mechanism 534 may use a magnet, clips, screws, etc.

[61] As before, a battery 512 is included for supplying DC voltage to the LEDs 504. A connector 536 is included in the attachment surface 530 of the housing 528 to facilitate connection of the LEDs 504 to the battery 512. One type of connector 536 that may be used is referred to as a chase nipple. Of course, other connectors 536 that may be used will be readily apparent to those skilled in the art in view of the teachings contained herein.

[62] Advantageously, the embodiments of the low-voltage lighting apparatus 500 described in connection with Figures 5 and 6 may easily and inexpensively be secured to existing light fixtures. To install the lighting apparatus 500 to a ballast cover within a light fixture, a hole is drilled into the ballast cover. The connector 536 snaps into the hole and locks into place. Wires 514 from the circuit board 511 may then be connected to the battery 512 through a hole in the connector 536. Accordingly, existing light fixtures may be easily and inexpensively retrofit with the lighting apparatus 500.

[63] As with the embodiments discussed previously, the lighting apparatus 500 shown in Figure 5 may be used to provide emergency lighting. In many cases, retrofitting existing light fixtures with the lighting apparatus 500 may be less expensive than installing a large backup system for providing emergency lighting.

[64] The lighting apparatus 500 shown in Figure 5 may include various additional components that are not shown in Figure 5. For example, the lighting apparatus 500 may also include a switching circuit and a battery charging circuit, as described above in connection with Figures 3 and 4.

[65] In the illustrated embodiment, one of the LEDs 504 coupled to the circuit board 511 is a battery test light 504a. The battery test light 504a indicates whether the battery 512 is charged, i.e., capable of supplying DC voltage. The battery test light 504a is directly coupled to the battery 512. Thus, the battery test light 504a is illuminated whenever the battery 512 is capable of supplying DC voltage, even if the other LEDs 504 are not illuminated.

[66] Figure 6 is a top plan view of the embodiment of the lighting apparatus 500 shown in Figure 5. The illumination surface 532 of the housing 528 is shown. The plurality of LEDs 504 protruding through the holes in the illumination surface 532 are also shown. The battery test light 504a is also shown.

[67] While specific embodiments and applications of the present invention have been illustrated and described, it is to be understood that the invention is not limited to the precise configuration and components disclosed herein. Various modifications, changes, and variations which will be apparent to those skilled in the art may be made in the arrangement, operation, and details of the methods and systems of the present invention disclosed herein without departing from the spirit and scope of the invention.

[68] What is claimed is:

1. An energy-efficient lighting apparatus, comprising:  
a ballast cover;  
a plurality of ballast cover holes in the ballast cover;  
a circuit board comprising a plurality of light-emitting diodes, wherein the circuit board is positioned adjacent the ballast cover so that the plurality of light-emitting diodes protrude through the plurality of ballast cover holes in the ballast cover.
2. The lighting apparatus of claim 1, further comprising a battery for supplying power to the plurality of light-emitting diodes.
3. The lighting apparatus of claim 2, further comprising a switching circuit for controlling illumination of the plurality of light-emitting diodes.
4. The lighting apparatus of claim 3, wherein the switching circuit comprises:  
a first portion for placing the switching circuit in communication with a wall switch;  
a second portion for coupling the switching circuit to the battery; and  
a third portion for coupling the switching circuit to the plurality of light-emitting diodes.
5. The lighting apparatus of claim 4, wherein the switching circuit couples the battery to the plurality of light-emitting diodes if the switching circuit is not receiving AC voltage from an AC voltage source that is coupled to the wall switch, and wherein the switching circuit does not couple the battery to the plurality of light-emitting diodes if the switching circuit is receiving the AC voltage from the AC voltage source.
6. The lighting apparatus of claim 4, wherein the switching circuit further comprises a fourth portion for receiving an alarm signal from an alarm device.
7. The lighting apparatus of claim 6, wherein the switching circuit couples the battery to the plurality of light-emitting diodes if the switching circuit is receiving the alarm signal.

8. The lighting apparatus of claim 2, further comprising a battery charging circuit for charging the battery.
9. The lighting apparatus of claim 8, wherein the battery charging circuit comprises:  
a first portion for coupling the battery charging circuit to an AC voltage source; and  
a second portion for coupling the battery charging circuit to the battery.
10. The lighting apparatus of claim 2, wherein the circuit board further comprises a battery test light coupled to the battery.
11. The lighting apparatus of claim 13, wherein the battery test light protrudes through one of the plurality of ballast cover holes.
12. An energy-efficient lighting apparatus for retrofit with an existing light fixture having a ballast cover, comprising:  
a housing having an attachment surface and an illumination surface;  
a plurality of illumination surface holes in the illumination surface;  
a circuit board comprising a plurality of light-emitting diodes, wherein the circuit board is positioned adjacent the housing so that the plurality of light-emitting diodes protrude through the plurality of illumination surface holes in the illumination surface; and  
a fastening mechanism for securing the attachment surface of the lighting apparatus to the ballast cover.
13. The lighting apparatus of claim 12, further comprising a battery for supplying power to the plurality of light-emitting diodes.
14. The lighting apparatus of claim 13, further comprising a switching circuit for controlling illumination of the plurality of light-emitting diodes.

15. The lighting apparatus of claim 14, wherein the switching circuit comprises:  
a first portion for placing the switching circuit in communication with a wall switch;  
a second portion for coupling the switching circuit to the battery; and  
a third portion for coupling the switching circuit to the plurality of light-emitting diodes.
16. The lighting apparatus of claim 15, wherein the switching circuit couples the battery to the plurality of light-emitting diodes if the switching circuit is not receiving AC voltage from an AC voltage source that is coupled to the wall switch, and wherein the switching circuit does not couple the battery to the plurality of light-emitting diodes if the switching circuit is receiving the AC voltage from the AC voltage source.
17. The lighting apparatus of claim 15, wherein the switching circuit further comprises a fourth portion for receiving an alarm signal from an alarm device.
18. The lighting apparatus of claim 17, wherein the switching circuit couples the battery to the plurality of light-emitting diodes if the switching circuit is receiving the alarm signal.
19. The lighting apparatus of claim 13, further comprising a battery charging circuit for charging the battery.
20. The lighting apparatus of claim 19, wherein the battery charging circuit comprises:  
a first portion for coupling the battery charging circuit to the AC voltage source; and  
a second portion for coupling the battery charging circuit to the battery.
21. The lighting apparatus of claim 13, wherein the circuit board further comprises a battery test light coupled to the battery.
22. The lighting apparatus of claim 21, wherein the battery test light protrudes through one of the plurality of illumination surface holes.
23. The lighting apparatus of claim 12, further comprising:

a connector in the attachment surface of the housing that snaps into a ballast cover hole in the ballast cover; and  
wires connecting the circuit board to the battery through the connector.

24. The lighting apparatus of claim 12, wherein the fastening mechanism comprises an adhesive strip having a protective cover.

25. A method for providing illumination to an area in an energy-efficient manner, comprising:

providing a ballast cover, the ballast cover having a plurality of ballast cover holes, the ballast cover being attachable to a light fixture;

providing a circuit board comprising a plurality of light-emitting diodes; and

positioning the circuit board adjacent the ballast cover so that the plurality of light-

emitting diodes protrude through the plurality of ballast cover holes in the ballast cover.

26. The method of claim 25, further comprising illuminating the plurality of light-emitting diodes when a light bulb within the light fixture is not illuminated.

27. The method of claim 25, further comprising not illuminating the plurality of light-emitting diodes when a light bulb within the light fixture is illuminated.

28. The method of claim 25, further comprising:

receiving an alarm signal from an alarm device; and

in response to receiving the alarm signal, illuminating the plurality of light-emitting diodes.

29. A method for retrofitting a light fixture with an energy-efficient lighting apparatus, the light fixture having a ballast cover, the method comprising:

providing a housing having an attachment surface and an illumination surface, wherein  
the illumination surface comprises a plurality of illumination surface holes;  
providing a circuit board comprising a plurality of light-emitting diodes;  
positioning the circuit board adjacent the housing so that the plurality of light-emitting  
diodes protrude through the plurality of illumination surface holes in the  
illumination surface; and  
securing the attachment surface of the housing to the ballast cover.

30. The method of claim 29, further comprising illuminating the plurality of light-emitting diodes when a light bulb within the light fixture is not illuminated.

31. The method of claim 29, further comprising not illuminating the plurality of light-emitting diodes when a light bulb within the light fixture is illuminated.

32. The method of claim 29, further comprising:  
receiving an alarm signal from an alarm device; and  
in response to receiving the alarm signal, illuminating the plurality of light-emitting diodes.



**LOW-VOLTAGE LIGHTING APPARATUS FOR SATISFYING AFTER-HOURS LIGHTING REQUIREMENTS, EMERGENCY LIGHTING REQUIREMENTS, AND LOW LIGHT REQUIREMENTS**

**ABSTRACT OF THE DISCLOSURE**

An energy-efficient lighting apparatus is disclosed. The lighting apparatus includes a ballast cover. The ballast cover includes a plurality of ballast cover holes. The lighting apparatus also includes a circuit board comprising a plurality of light-emitting diodes. The circuit board is positioned adjacent the ballast cover so that the plurality of light-emitting diodes protrude through the plurality of ballast cover holes in the ballast cover. The lighting apparatus may also include a battery for supplying power to the plurality of light-emitting diodes.

**Docket No.:** 3358.2.1

This Page Is Inserted by IFW Operations  
and is not a part of the Official Record

## **BEST AVAILABLE IMAGES**

Defective images within this document are accurate representations of the original documents submitted by the applicant.

Defects in the images may include (but are not limited to):

- BLACK BORDERS
- TEXT CUT OFF AT TOP, BOTTOM OR SIDES
- FADED TEXT
- ILLEGIBLE TEXT
- SKEWED/SLANTED IMAGES
- COLORED PHOTOS
- BLACK OR VERY BLACK AND WHITE DARK PHOTOS
- GRAY SCALE DOCUMENTS

**IMAGES ARE BEST AVAILABLE COPY.**

**As rescanning documents *will not* correct images,  
please do not report the images to the  
Image Problem Mailbox.**

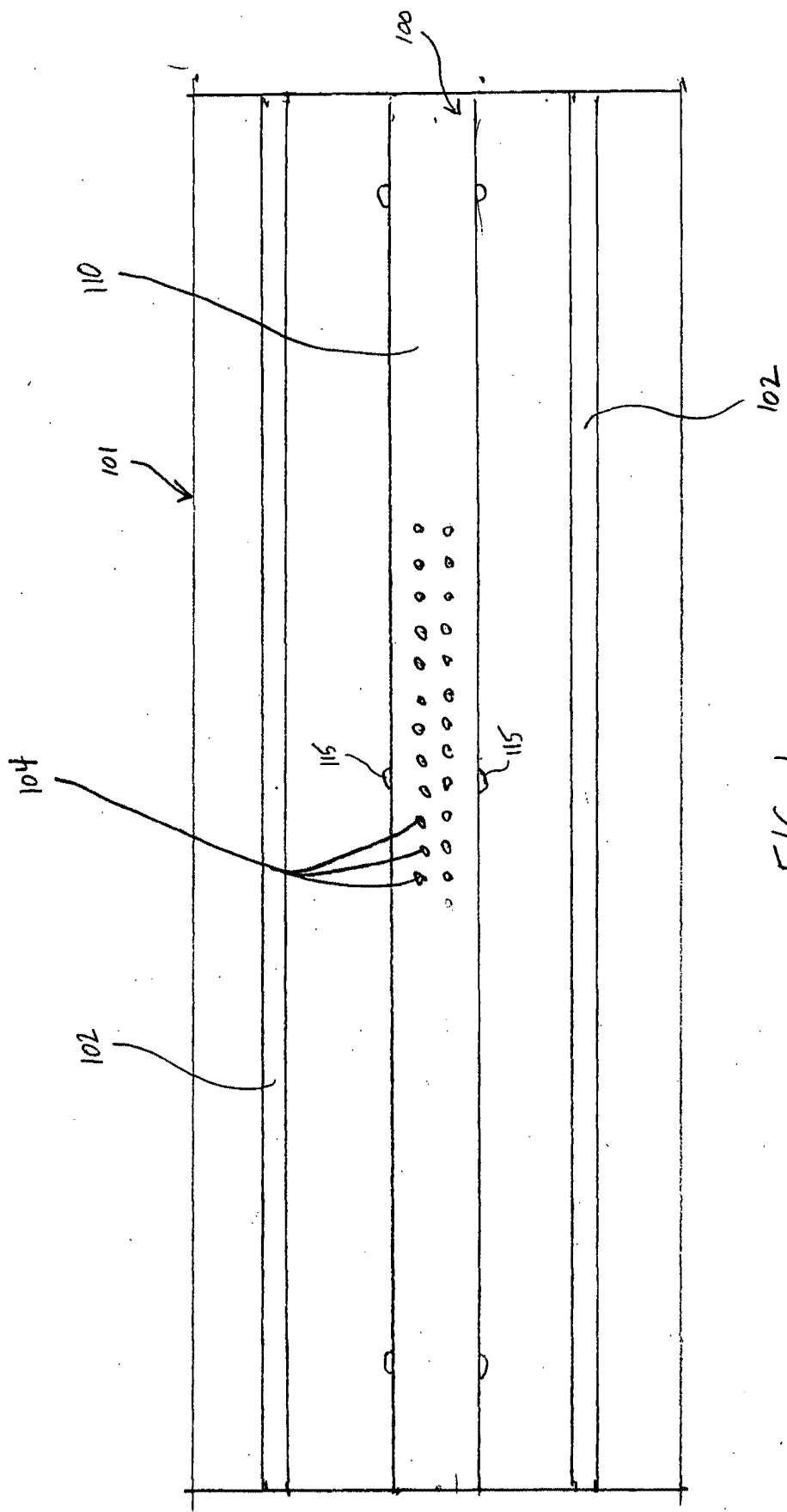

FIG. 1

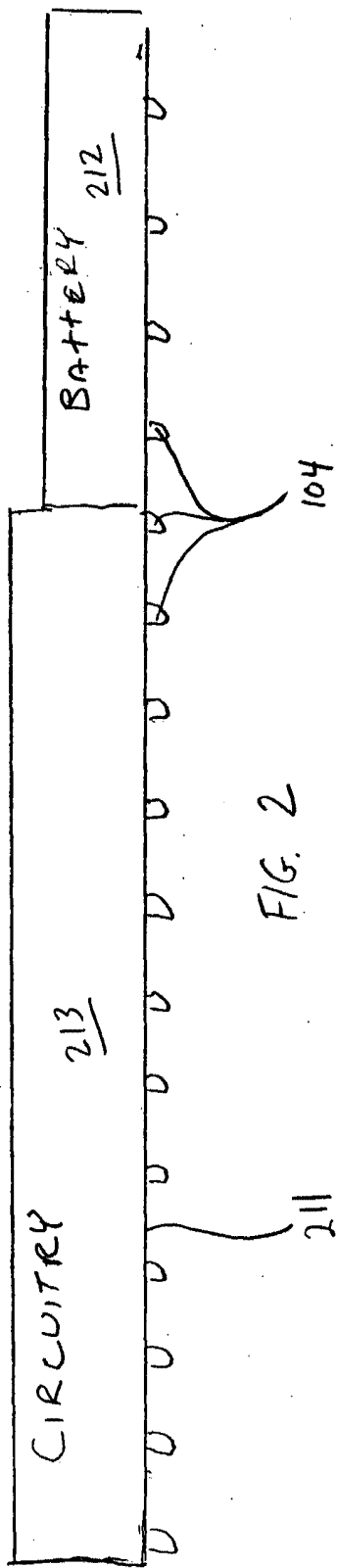

FIG. 2

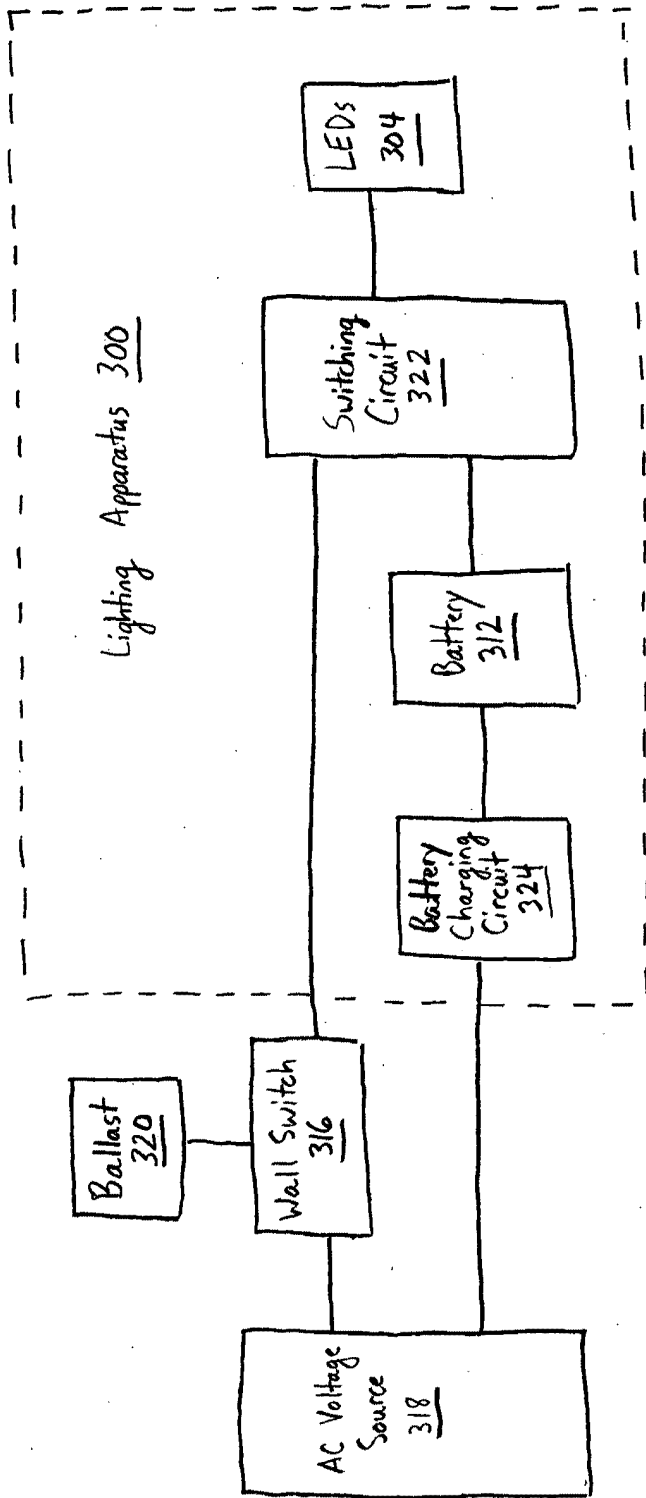

FIG. 3

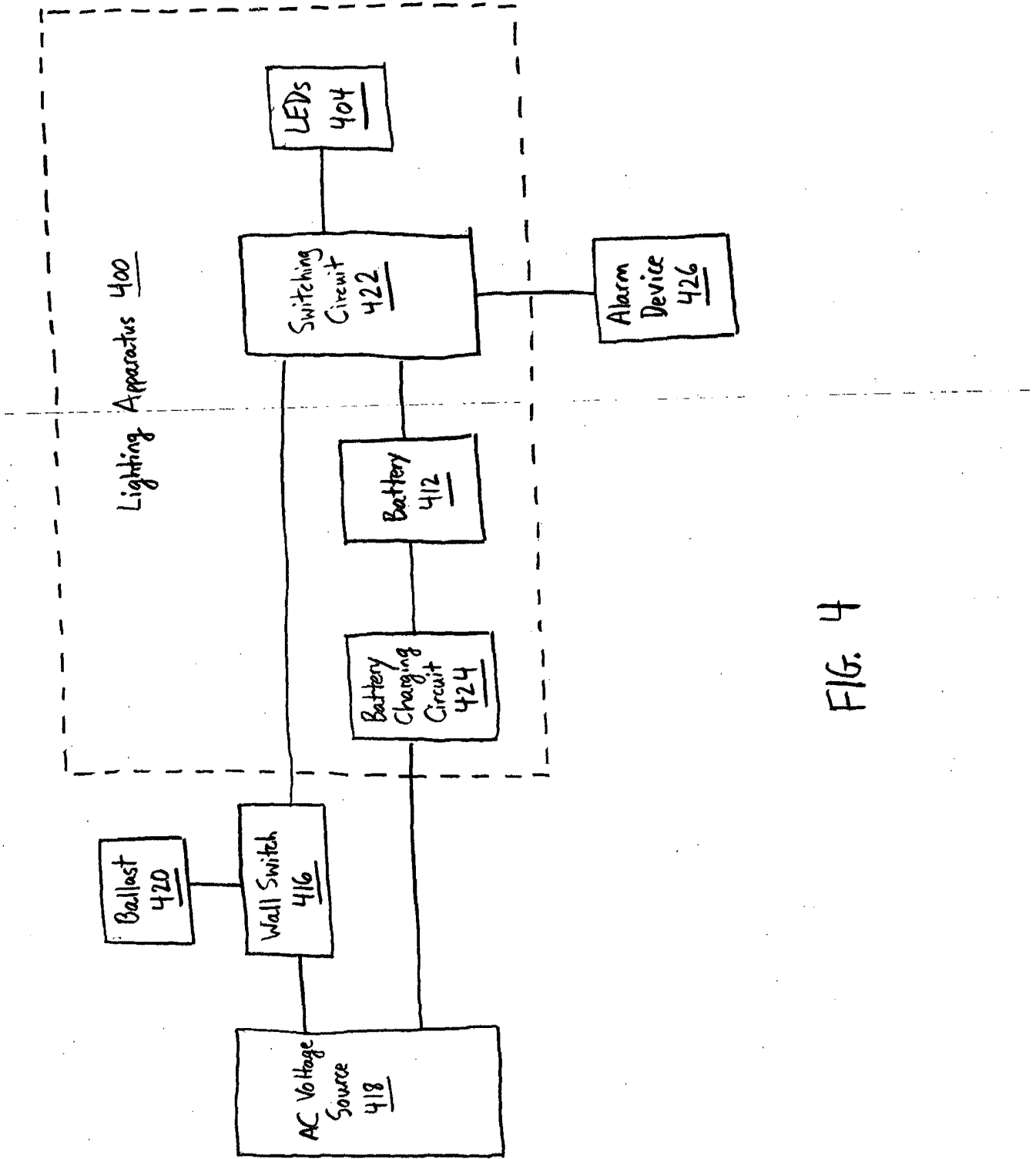

FIG. 4

BEST AVAILABLE COPY

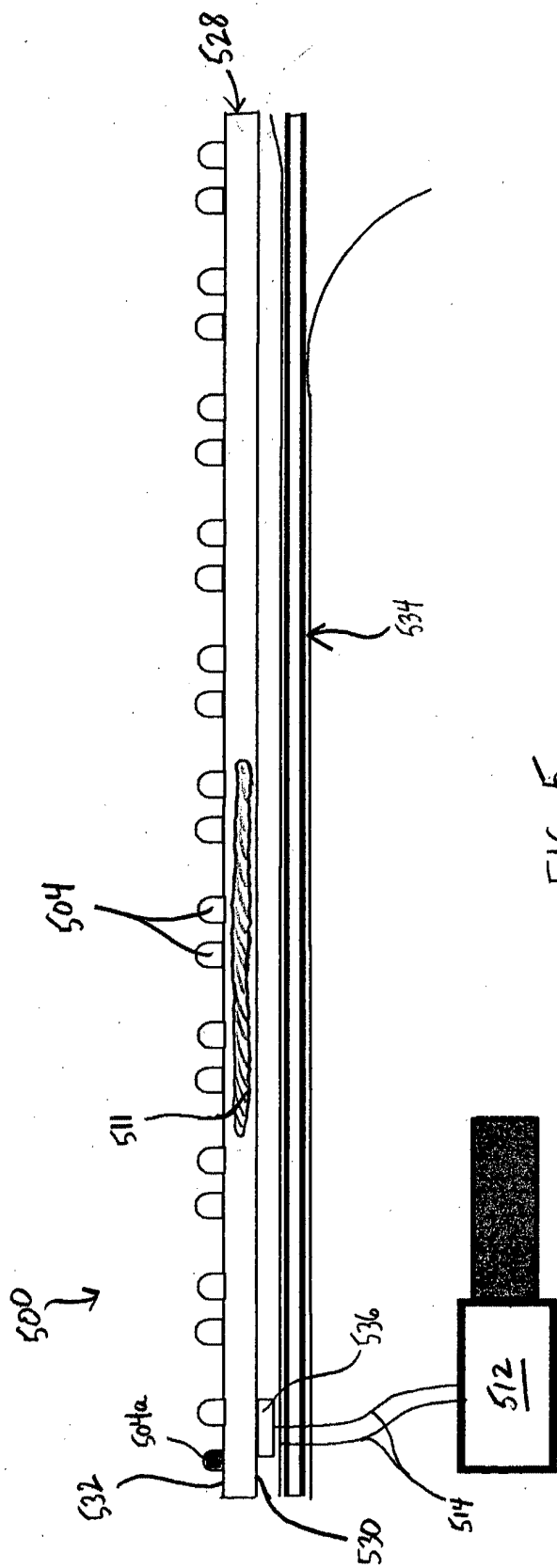

FIG. 5

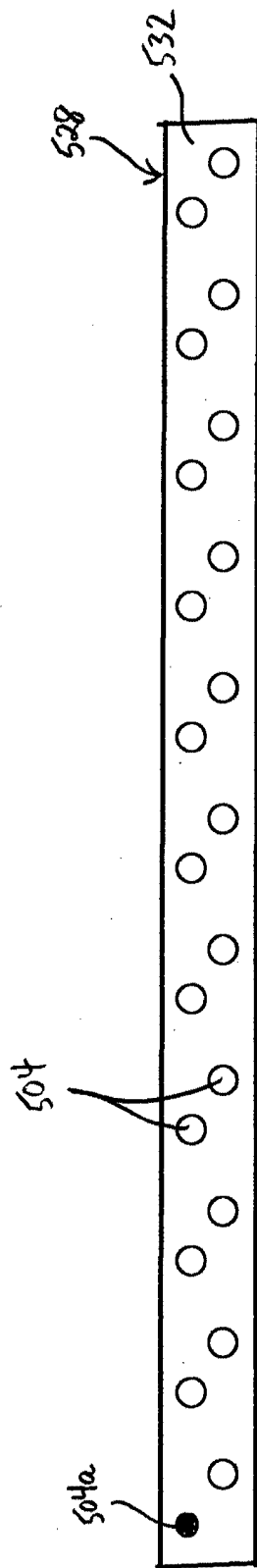

FIG. 6

# PATENT APPLICATION FEE DETERMINATION RECORD

Effective October 1, 2003

Application or Docket Number

10733853

## CLAIMS AS FILED - PART I

	(Column 1)	(Column 2)
TOTAL CLAIMS	32	
FOR	NUMBER FILED	NUMBER EXTRA
TOTAL CHARGEABLE CLAIMS	32 minus 20 =	* 12
INDEPENDENT CLAIMS	4 minus 3 =	* 1
MULTIPLE DEPENDENT CLAIM PRESENT <input type="checkbox"/>		

\* If the difference in column 1 is less than zero, enter "0" in column 2

SMALL ENTITY TYPE

OR OTHER THAN SMALL ENTITY

RATE	FEE
BASIC FEE	385.00
X\$ 9=	108
X43=	43
+145=	
TOTAL	536

RATE	FEE
BASIC FEE	770.00
X\$18=	
X86=	
+290=	
TOTAL	

## CLAIMS AS AMENDED - PART II

	(Column 1)	(Column 2)	(Column 3)
AMENDMENT A	CLAIMS REMAINING AFTER AMENDMENT		HIGHEST NUMBER PREVIOUSLY PAID FOR
	Total	*	Minus **
	Independent	*	Minus ***
FIRST PRESENTATION OF MULTIPLE DEPENDENT CLAIM <input type="checkbox"/>			

SMALL ENTITY OR

OTHER THAN SMALL ENTITY

RATE	ADDITIONAL FEE
X\$ 9=	
X43=	
+145=	
TOTAL ADDIT. FEE	

RATE	ADDITIONAL FEE
X\$18=	
X86=	
+290=	
TOTAL ADDIT. FEE	

	(Column 1)	(Column 2)	(Column 3)
AMENDMENT B	CLAIMS REMAINING AFTER AMENDMENT		HIGHEST NUMBER PREVIOUSLY PAID FOR
	Total	*	Minus **
	Independent	*	Minus ***
FIRST PRESENTATION OF MULTIPLE DEPENDENT CLAIM <input type="checkbox"/>			

RATE	ADDITIONAL FEE
X\$ 9=	
X43=	
+145=	
TOTAL ADDIT. FEE	

RATE	ADDITIONAL FEE
X\$18=	
X86=	
+290=	
TOTAL ADDIT. FEE	

	(Column 1)	(Column 2)	(Column 3)
AMENDMENT C	CLAIMS REMAINING AFTER AMENDMENT		HIGHEST NUMBER PREVIOUSLY PAID FOR
	Total	*	Minus **
	Independent	*	Minus ***
FIRST PRESENTATION OF MULTIPLE DEPENDENT CLAIM <input type="checkbox"/>			

RATE	ADDITIONAL FEE
X\$ 9=	
X43=	
+145=	
TOTAL ADDIT. FEE	

RATE	ADDITIONAL FEE
X\$18=	
X86=	
+290=	
TOTAL ADDIT. FEE	

\* If the entry in column 1 is less than the entry in column 2, write "0" in column 3.

\*\* If the "Highest Number Previously Paid For" IN THIS SPACE is less than 20, enter "20."

\*\*\* If the "Highest Number Previously Paid For" IN THIS SPACE is less than 3, enter "3."

The "Highest Number Previously Paid For" (Total or Independent) is the highest number found in the appropriate box in column 1.





CERTIFICATE OF MAILING

I hereby certify that this correspondence is being deposited with the United States Postal Service as first class mail in an envelope addressed to: Mail Stop Petition, Commissioner for Patents, P.O. Box 1450, Alexandria, VA 22313-1450, on December 11, 2003.

*Thomas M. Hardman*  
Attorney for Applicants

PATENT  
Docket No. 3358.2.1

IN THE UNITED STATES PATENT AND TRADEMARK OFFICE

Applicants:	Nielson et al.	10,733,853	)	
			)	
Serial No.:	not yet assigned		)	
			)	
Filed:	December 11, 2003		)	Group Art
			)	Unit: not yet
			)	assigned
For:	LOW-VOLTAGE LIGHTING APPARATUS FOR			)
	SATISFYING AFTER-HOURS LIGHTING			)
	REQUIREMENTS, EMERGENCY LIGHTING			)
	REQUIREMENTS, AND LOW LIGHT			)
	REQUIREMENTS			)
Examiner:	not yet assigned			

PETITION TO MAKE SPECIAL UNDER 37 C.F.R. § 1.102(c)

Mail Stop Petition  
Commissioner for Patents  
P.O. Box 1450  
Alexandria, VA 22313-1450

Dear Sir:

Applicants hereby petition to make the above-identified patent application special under the provisions of 37 C.F.R. § 1.102(c) and MPEP 708.02.

The invention in the above-identified patent application materially contributes to the more efficient utilization and conservation of energy resources. The invention relates to an energy-efficient lighting apparatus that provides sufficient illumination to satisfy after-hours lighting requirements, emergency lighting requirements, and/or low light requirements.

Embodiments of the lighting apparatus disclosed in the above-identified patent application utilize light-emitting diodes (LEDs). The use of LEDs to satisfy after-hours lighting requirements, emergency lighting requirements, and/or low light requirements may result in significant power savings as compared to presently available technology. For example, fluorescent lights are presently used to provide some or all of the aforementioned lighting. However, LEDs consume significantly less power than fluorescent lights. For example, the power consumption of an average fluorescent light bulb is 77-96 watts. In contrast, the power consumption of 80 LEDs is only approximately 8 watts. Accordingly, the LEDs in the disclosed lighting apparatus may be powered by a relatively small and inexpensive battery.

Some embodiments of the lighting apparatus disclosed in the above-identified application may easily and inexpensively be attached to existing light fixtures. Thus, existing light fixtures may be retrofit with the disclosed lighting apparatus in order to achieve the energy savings described above without incurring significant expense.

In view of the foregoing, Applicants submit that the requirements set forth in 37 C.F.R. § 1.102(c) and MPEP 708.02 have been satisfied. Applicants respectfully request that this application be granted special status for the purpose of accelerating examination.

Respectfully submitted,



Thomas M. Hardman  
Reg. No. 51,777  
Attorney for Applicant

Date: December 11, 2003

MADSON & METCALF  
Gateway Tower West  
15 West South Temple, Suite 900  
Salt Lake City, Utah 84101  
Telephone: 801/537-1700



**CERTIFICATE OF MAILING**

I hereby certify that this correspondence is being deposited with the United States Postal Service as first class mail in an envelope addressed to: Commissioner for Patents, P.O. Box 1450, Alexandria, VA 22313-1450, on March 22, 2004.

*Lyman O. Nielson*  
Attorney for Applicant(s)

IN THE UNITED STATES PATENT AND TRADEMARK OFFICE

Appl. No. : 10/733,853  
Applicant : Lyman O. Nielson et al.  
Title : LOW-VOLTAGE LIGHTING APPARATUS FOR SATISFYING AFTER-HOURS LIGHTING REQUIREMENTS, EMERGENCY LIGHTING REQUIREMENTS, AND LOW LIGHT REQUIREMENTS  
Filed : December 11, 2003  
TC/A.U. : (not yet assigned)  
Examiner : (not yet assigned)  
Docket No. : 3358.2.1  
Customer No. : 21552

Commissioner for Patents  
P.O. Box 1450  
Alexandria, VA 22313-1450

**TRANSMITTAL OF INFORMATION DISCLOSURE STATEMENT**

Dear Sir:

Transmitted herewith is an Information Disclosure Statement disclosing information which has come to the attention of applicants and/or their attorneys and is being submitted so as to comply with the duty of disclosure set forth in 37 C.F.R. § 1.56. In accordance with 37 C.F.R. § 1.97(b), the enclosed Statement is being filed within three (3) months of the filing date of the above-identified application or before the mailing date of a first Action on the merits.

Neither applicants nor their attorneys make any representation that any information disclosed herein may be "prior art" within the meaning of that term under 35 U.S.C. § 102 or § 103. Moreover, pursuant to 37 C.F.R. § 1.97, the filing of this Information Disclosure Statement

shall not be construed as a representation that a search has been made or as an admission that the information cited herein is, or is considered to be, material to patentability as defined in 37 C.F.R. § 1.56(b).

Accordingly, we are not enclosing copies of the references.

In accordance with 37 C.F.R. § 1.98, transmitted herewith are:

1. A completed copy of Forms PTO/SB/08a and PTO/SB08b "Information Disclosure Statement by Applicant" listing the patents, publications and other information being submitted for consideration; and
2. A legible copy of each patent, publication and other item of information in written form listed on the enclosed Forms PTO/SB/08a and PTO/SB/08b (for applications filed after June 30, 2003), except for copies of U.S. patents and published U.S. patent applications which are not required for applications filed after June 30, 2003.

As this application was filed after June 30, 2003, copies of the U.S. patents and published U.S. patent applications listed on the enclosed Form PTO/SB/08a are not required and, therefore, not included herewith.

Respectfully submitted,

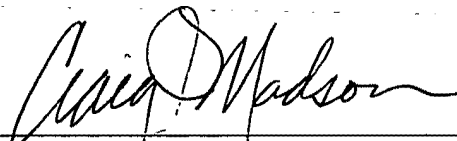

---

Craig J. Madson  
Reg. No. 29,407  
Attorney for Applicant(s)

Date: March 22, 2004

MADSON & METCALF  
Gateway Tower West  
15 West South Temple, Suite 900  
Salt Lake City, Utah 84101  
Telephone: 801/537-1700



PTO/SB/08a (08-03)

Approved for use through 06/30/2006. OMB 0651-0031  
U.S. Patent and Trademark Office: U.S. DEPARTMENT OF COMMERCE

Under the Paperwork Reduction Act of 1995, no persons are required to respond to a collection of information unless it contains a valid OMB control number.

Substitute for form 1449A/PTO		<b>Complete if Known</b>	
<b>INFORMATION DISCLOSURE STATEMENT BY APPLICANT</b>  <i>(use as many sheets as necessary)</i>		Application Number	10/733,853
		Filing Date	December 11, 2003
		First Named Inventor	Lyman O. Nielson
		Group Art Unit	
		Examiner Name	
		Attorney Docket Number	3358.2.1
Sheet	1	Of	1

U.S. PATENT DOCUMENTS					
Examiner Initials *	Cite No. <sup>1</sup>	Document Number	Publication Date MM-DD-YYYY	Name of Patentee or Applicant of Cited Document	Pages, Columns, Lines, Where Relevant Passages or Relevant Figures Appear
		Number - Kind Code <sup>2</sup> (if known)			
	U1	US-4,255,746	Mar. 10, 1981	Johnson et al.	
	U2	US-4,419,658	Dec. 6, 1983	Jarosz et al.	
	U3	US-4,454,452	Jun. 12, 1984	Feldstein	
	U4	US-4,617,561	Oct. 14, 1986	Brown	
	U5	US-D290,406	Jun. 16, 1987	Brown	
	U6	US-4,945,280	Jul. 31, 1990	Beghelli	
	U7	US-4,977,351	Dec. 11, 1990	Bavaro et al.	
	U8	US-5,130,909	Jul. 14, 1992	Gross	
	U9	US-5,146,209	Sep. 8, 1992	Beghelli	
	U10	US-5,145,247	Sep. 8, 1992	Mandy	
	U11	US-5,365,145	Nov. 15, 1994	Fields	
	U12	US-5,416,384	May 16, 1995	Bavaro	
	U13	US-5,587,705	Dec. 24, 1996	Morris	
	U14	US-5,731,759	Mar. 24, 1998	Finucan	
	U15	US-5,739,639	Apr. 14, 1998	Johnson	
	U16	US-5,786,767	Jul. 28, 1998	Severino	
	U17	US-5,936,532	Aug. 10, 1999	Peralta	
	U18	US-6,133,839	Oct. 17, 2000	Ellul, Jr. et al.	
	U19	US-6,249,221	Jun. 19, 2001	Reed	
	U20	US-6,384,724	May 7, 2002	Landais	
	U21	US-6,420,973	Jul. 16, 2002	Acevedo	
	U22	US-6,609,804	Aug. 26, 2003	Nolan et al.	
	U23	US-6,624,750	Sep. 23, 2003	Marman et al.	

Examiner Signature		Date Considered	
--------------------	--	-----------------	--

\* EXAMINER: Initial if reference considered, whether or not citation is in conformance with MPEP 609. Draw line through citation if not in conformance and not considered. Include copy of this form with next communication to applicant. <sup>1</sup> Applicant's unique citation designation number (optional). <sup>2</sup> See Kinds Codes of USPTO Patent Documents at [www.uspto.gov](http://www.uspto.gov) or MPEP 901.04. <sup>3</sup> Enter Office that issued the document, by the two-letter code (WIPO Standard ST.3). <sup>4</sup> For Japanese patent documents, the indication of the year of the reign of the Emperor must precede the serial number of the patent document. <sup>5</sup> Kind of document by the appropriate symbols as indicated on the document under WIPO Standard ST. 16 if possible. <sup>6</sup> Applicant is to place a check mark here if English language Translation is attached.

This collection of information is required by 37 CFR 1.97 and 1.98. The information is required to obtain or retain a benefit by the public which is to file (and by the USPTO to process) an application. Confidentiality is governed by 35 U.S.C. 122 and 37 CFR 1.14. This collection is estimated to take 2 hours to complete, including gathering, preparing, and submitting the completed application form to the USPTO. Time will vary depending upon the individual case. Any comments on the amount of time you are required to complete this form and/or suggestions for reducing this burden, should be sent to the Chief Information Officer, U.S. Patent and Trademark Office, U.S. Department of Commerce, P.O. Box 1450, Alexandria, VA 22313-1450. **DO NOT SEND FEES OR COMPLETED FORMS TO THIS ADDRESS. SEND TO: Commissioner for Patents, P.O. Box 1450, Alexandria, VA 22313-1450.**

If you need assistance in completing this form, call 1-800-PTO-9199 and selection option 2.

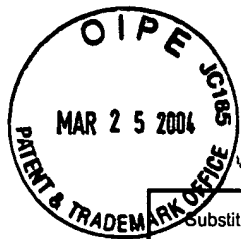

Under the Paperwork Reduction Act of 1995, no persons are required to respond to a collection of information unless it contains a valid OMB control number.

Substitute for form 1449B/PTO  <b>INFORMATION DISCLOSURE STATEMENT BY APPLICANT</b>  <i>(use as many sheets as necessary)</i>  Sheet        1        Of        1	<b>Complete if Known</b>	
	Application Number	10/733,853
	Filing Date	December 11, 2003
	First Named Inventor	Lyman O. Nielson
	Group Art Unit	
	Examiner Name	
	Attorney Docket Number	3358.2.1

NON PATENT LITERATURE DOCUMENTS			
Examiner Initials *	Cite No. <sup>1</sup>	Include name of the author (in CAPITAL LETTERS), title of the article (when appropriate), title of the item (book, magazine, journal, serial, symposium, catalog, etc.), date, page(s), volume-issue number(s), publisher, city and/or country where published.	T <sup>2</sup>
	O1	ARPAD A. BERGH, "A View on The Future of Solid State Lighting"	
	O2	"Egress Aisles – Exit Signs – Egress Lighting Requirements"	
	O3	"Down Light / Night Light Strip"	
	O4	"Super Energy Efficient Solid-State Egress/Night Lighting"	
	O5	"GTD Generator Transfer Device For Generator-Supplied Lighting"	
	O6	"LED Light Strip Illuminator Module"	
	O7	STEVE JOHNSON, "The Solid State Lighting Initiative: An Industry/DOE Collaborative Effort," Architectural Lighting, Nov./Dec. 2000, pp. 1-5	
	O8	"Surviv Lite Emergency Egress Lighting"	
	O9	MARK KENDALL and MICHAEL SCHOLAND, "Energy Savings Potential of Solid State Lighting in General Lighting Applications," April 2001	
	O10	"The LED Advantage"	
	O11	"Homeowners Insurance – Rising Cost of Homeowners Insurance"	
	O12	"School, college, and university dormitory, fraternity, and sorority house fires"	
	O13	"Light Emitting Diodes for Lighting Applications"	
	O14	"Super Energy Efficient Solid-State Egress/Night Lighting"	
	O15	"Kidde Ionization Smoke Alarm w/ Exit Light"	
	O16	"3 in 1 LED Emergency Light"	
	O17	"PowerFailure Night Light," User's Manual	
	O18	"Gas and Smoke Detector – ESM-768 Semiconductor / Ionisation Technology"	
	O19	"SA358: Smoke Alarm with Emergency Light"	
	O20	"Sage Lighting Ltd. LED Lighting Products"	

Examiner Signature		Date Considered	
--------------------	--	-----------------	--

\* EXAMINER: Initial if reference considered, whether or not citation is in conformance with MPEP 609. Draw line through citation if not in conformance and not considered. Include copy of this form with next communication to applicant.

<sup>1</sup> Applicant's unique citation designation number (optional). <sup>2</sup> Applicant is to place a check mark here if English language Translation is attached.

This collection of information is required by 37 CFR 1.97 and 1.98. The information is required to obtain or retain a benefit by the public which is to file (and by the USPTO to process) an application. Confidentiality is governed by 35 U.S.C. 122 and 37 CFR 1.14. This collection is estimated to take 2 hours to complete, including gathering, preparing, and submitting the completed application form to the USPTO. Time will vary depending upon the individual case. Any comments on the amount of time you are required to complete this form and/or suggestions for reducing this burden, should be sent to the Chief Information Officer, U.S. Patent and Trademark Office, U.S. Department of Commerce, P.O. Box 1450, Alexandria, VA 22313-1450. DO NOT SEND FEES OR COMPLETED FORMS TO THIS ADDRESS. SEND TO: Commissioner for Patents, P.O. Box 1450, Alexandria, VA 22313-1450.

If you need assistance in completing this form, call 1-800-PTO-9199 and selection option 2.

**UNITED STATES PATENT AND TRADEMARK OFFICE**

 UNITED STATES DEPARTMENT OF COMMERCE  
 United States Patent and Trademark Office  
 Address: COMMISSIONER FOR PATENTS  
 P.O. Box 1450  
 Alexandria, Virginia 22313-1450  
 www.uspto.gov

APPLICATION NUMBER	FILING OR 371 (c) DATE	FIRST NAMED APPLICANT	ATTORNEY DOCKET NUMBER
10/733,853	12/11/2003	Lyman O. Nielson	3358.2.1

 21552  
 MADSON & METCALF  
 GATEWAY TOWER WEST  
 SUITE 900  
 15 WEST SOUTH TEMPLE  
 SALT LAKE CITY, UT 84101

**CONFIRMATION NO. 9007**
**FORMALITIES LETTER**

\*OC000000012704995\*

Date Mailed: 05/18/2004

**NOTICE TO FILE MISSING PARTS OF NONPROVISIONAL APPLICATION**
**FILED UNDER 37 CFR 1.53(b)**
*Filing Date Granted*
**Items Required To Avoid Abandonment:**

An application number and filing date have been accorded to this application. The item(s) indicated below, however, are missing. Applicant is given **TWO MONTHS** from the date of this Notice within which to file all required items and pay any fees required below to avoid abandonment. Extensions of time may be obtained by filing a petition accompanied by the extension fee under the provisions of 37 CFR 1.136(a).

- The statutory basic filing fee is missing.  
*Applicant must submit \$ 385 to complete the basic filing fee for a small entity.*
- The oath or declaration is missing.  
*A properly signed oath or declaration in compliance with 37 CFR 1.63, identifying the application by the above Application Number and Filing Date, is required.*
- To avoid abandonment, a late filing fee or oath or declaration surcharge as set forth in 37 CFR 1.16(e) of \$65 for a small entity in compliance with 37 CFR 1.27, must be submitted with the missing items identified in this letter.

The application is informal since it does not comply with the regulations for the reason(s) indicated below.

The required item(s) identified below must be timely submitted to avoid abandonment:

- Replacement drawings in compliance with 37 CFR 1.84 and 37 CFR 1.121 are required. The drawings submitted are not acceptable because:
  - The drawings must be reasonably free from erasures and must be free from alterations, overwriting, interlineations, folds, and copy marks. See Figure(s) 4.

The applicant needs to satisfy supplemental fees problems indicated below.

The required item(s) identified below must be timely submitted to avoid abandonment:

- Additional claim fees of **\$151** as a small entity, including any required multiple dependent claim fee, are required. Applicant must submit the additional claim fees or cancel the additional claims for which fees are due.

**SUMMARY OF FEES DUE:**

Total additional fee(s) required for this application is **\$601** for a Small Entity

- **\$385** Statutory basic filing fee.
- **\$65** Late oath or declaration Surcharge.
- Total additional claim fee(s) for this application is **\$151**
  - **\$43** for **1** independent claims over 3.
  - **\$108** for **12** total claims over 20.

Replies should be mailed to: Mail Stop Missing Parts  
Commissioner for Patents  
P.O. Box 1450  
Alexandria VA 22313-1450

---

*A copy of this notice **MUST** be returned with the reply.*



---

Customer Service Center  
Initial Patent Examination Division (703) 308-1202

PART 3 - OFFICE COPY





## UNITED STATES PATENT AND TRADEMARK OFFICE

UNITED STATES DEPARTMENT OF COMMERCE  
 United States Patent and Trademark Office  
 Address: COMMISSIONER FOR PATENTS  
 P.O. Box 1450  
 Alexandria, Virginia 22313-1450  
 www.uspto.gov

APPLICATION NUMBER	FILING OR 371 (c) DATE	FIRST NAMED APPLICANT	ATTORNEY DOCKET NUMBER
10/733,853	12/11/2003	Lyman O. Nielson	3358.2.1

21552  
 MADSON & METCALF  
 GATEWAY TOWER WEST  
 SUITE 900  
 15 WEST SOUTH TEMPLE  
 SALT LAKE CITY, UT 84101

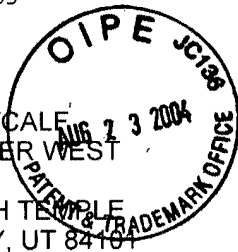

CONFIRMATION NO. 9007

## FORMALITIES LETTER



\*OC00000012704995\*

Date Mailed: 05/18/2004

## NOTICE TO FILE MISSING PARTS OF NONPROVISIONAL APPLICATION

08/24/2004 DTESSEM1 00000034 10733853

FILED UNDER 37 CFR 1.53(b)

01 FC:2001	385.00	OP
02 FC:2202	108.00	OP
03 FC:2201	43.00	OP
04 FC:2051	65.00	OP

*Filing Date Granted*Items Required To Avoid Abandonment:

An application number and filing date have been accorded to this application. The item(s) indicated below, however, are missing. Applicant is given **TWO MONTHS** from the date of this Notice within which to file all required items and pay any fees required below to avoid abandonment. Extensions of time may be obtained by filing a petition accompanied by the extension fee under the provisions of 37 CFR 1.136(a).

- The statutory basic filing fee is missing.  
*Applicant must submit \$ 385 to complete the basic filing fee for a small entity.*
- The oath or declaration is missing.  
*A properly signed oath or declaration in compliance with 37 CFR 1.63, identifying the application by the above Application Number and Filing Date, is required.*
- To avoid abandonment, a late filing fee or oath or declaration surcharge as set forth in 37 CFR 1.16(e) of \$65 for a small entity in compliance with 37 CFR 1.27, must be submitted with the missing items identified in this letter.

The application is informal since it does not comply with the regulations for the reason(s) indicated below.

The required item(s) identified below must be timely submitted to avoid abandonment:

- Replacement drawings in compliance with 37 CFR 1.84 and 37 CFR 1.121 are required. The drawings submitted are not acceptable because:
  - The drawings must be reasonably free from erasures and must be free from alterations, overwriting, interlineations, folds, and copy marks. See Figure(s) 4.

The applicant needs to satisfy supplemental fees problems indicated below.

The required item(s) identified below must be timely submitted to avoid abandonment:

- Additional claim fees of \$151 as a small entity, including any required multiple dependent claim fee, are required. Applicant must submit the additional claim fees or cancel the additional claims for which fees are due.

**SUMMARY OF FEES DUE:**

Total additional fee(s) required for this application is \$601 for a Small Entity

- \$385 Statutory basic filing fee.
- \$65 Late oath or declaration Surcharge.
- Total additional claim fee(s) for this application is \$151
  - \$43 for 1 independent claims over 3.
  - \$108 for 12 total claims over 20.

Replies should be mailed to: Mail Stop Missing Parts  
Commissioner for Patents  
P.O. Box 1450  
Alexandria VA 22313-1450

---

*A copy of this notice **MUST** be returned with the reply.*

*Tsegerach*

Customer Service Center

Initial Patent Examination Division (703) 308-1202

PART 2 - COPY TO BE RETURNED WITH RESPONSE

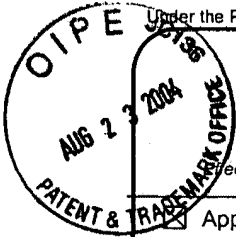

# FEE TRANSMITTAL for FY 2004

Effective 10/01/2003. Patent fees are subject to annual revision.

Applicant claims small entity status. See 37 CFR 1.27

**TOTAL AMOUNT OF PAYMENT (\$)** 656.00

Complete if Known

Application Number	10/733,853
Filing Date	December 11, 2003
First Named Inventor	Lyman O. Nielson
Examiner Name	
Group / Art Unit	2875
Attorney Docket No.	3358.2.1

METHOD OF PAYMENT (check all that apply)	FEE CALCULATION (continued)																																																																																																																																																																																																																																																																										
<input type="checkbox"/> Check <input checked="" type="checkbox"/> Credit card <input type="checkbox"/> Money <input type="checkbox"/> Other <input type="checkbox"/> None Order <input checked="" type="checkbox"/> Deposit Account: Deposit Account Number: <input type="text" value="13-0763"/> Deposit Account Name: <input type="text" value="Madson &amp; Metcalf"/> The Commissioner is authorized to: (check all that apply) <input checked="" type="checkbox"/> Charge fee(s) indicated below <input checked="" type="checkbox"/> Credit any overpayments <input type="checkbox"/> Charge any additional fee(s) during the pendency of this application <input type="checkbox"/> Charge fee(s) indicated below, except for the filing fee to the above-identified deposit account.	<b>3. ADDITIONAL FEES</b> <table border="1" style="width:100%"> <thead> <tr> <th colspan="2">Large Entity</th> <th colspan="2">Small Entity</th> <th rowspan="2">Fee Description</th> <th rowspan="2">Fee Paid</th> </tr> <tr> <th>Fee Code</th> <th>Fee (\$)</th> <th>Fee Code</th> <th>Fee (\$)</th> </tr> </thead> <tbody> <tr><td>1051</td><td>130</td><td>2051</td><td>65</td><td>Surcharge - late filing fee or oath</td><td>65</td></tr> <tr><td>1052</td><td>50</td><td>2052</td><td>25</td><td>Surcharge - late provisional filing fee or cover sheet.</td><td></td></tr> <tr><td>1053</td><td>130</td><td>1053</td><td>130</td><td>Non-English specification</td><td></td></tr> <tr><td>1812</td><td>2,520</td><td>1812</td><td>2,520</td><td>For filing a request for reexamination</td><td></td></tr> <tr><td>1804</td><td>920*</td><td>1804</td><td>920*</td><td>Requesting publication of SIR prior to Examiner action</td><td></td></tr> <tr><td>1805</td><td>1,840*</td><td>1805</td><td>1,840*</td><td>Requesting publication of SIR after Examiner action</td><td></td></tr> <tr><td>1251</td><td>110</td><td>2251</td><td>55</td><td>Extension for reply within first month</td><td>55</td></tr> <tr><td>1252</td><td>420</td><td>2252</td><td>210</td><td>Extension for reply within second month</td><td></td></tr> <tr><td>1253</td><td>950</td><td>2253</td><td>475</td><td>Extension for reply within third month</td><td></td></tr> <tr><td>1254</td><td>1,480</td><td>2254</td><td>740</td><td>Extension for reply within fourth month</td><td></td></tr> <tr><td>1255</td><td>2,010</td><td>2255</td><td>1,005</td><td>Extension for reply within fifth month</td><td></td></tr> <tr><td>1401</td><td>330</td><td>2401</td><td>165</td><td>Notice of Appeal</td><td></td></tr> <tr><td>1402</td><td>330</td><td>2402</td><td>165</td><td>Filing a brief in support of an appeal</td><td></td></tr> <tr><td>1403</td><td>290</td><td>2403</td><td>145</td><td>Request for oral hearing</td><td></td></tr> <tr><td>1451</td><td>1,510</td><td>1451</td><td>1,510</td><td>Petition to institute a public use proceeding</td><td></td></tr> <tr><td>1452</td><td>110</td><td>2452</td><td>55</td><td>Petition to revive - unavoidable</td><td></td></tr> <tr><td>1453</td><td>1,330</td><td>2453</td><td>665</td><td>Petition to revive - unintentional</td><td></td></tr> <tr><td>1501</td><td>1,330</td><td>2501</td><td>665</td><td>Utility issue fee (or reissue)</td><td></td></tr> <tr><td>1502</td><td>480</td><td>2502</td><td>240</td><td>Design issue fee</td><td></td></tr> <tr><td>1503</td><td>640</td><td>2503</td><td>320</td><td>Plant issue fee</td><td></td></tr> <tr><td>1460</td><td>130</td><td>1460</td><td>130</td><td>Petitions to the Commissioner</td><td></td></tr> <tr><td>1807</td><td>50</td><td>1807</td><td>50</td><td>Processing fee under 37 CFR 1.17 (q)</td><td></td></tr> <tr><td>1806</td><td>180</td><td>1806</td><td>180</td><td>Submission of Information Disclosure Stmt</td><td></td></tr> <tr><td>8021</td><td>40</td><td>8021</td><td>40</td><td>Recording each patent assignment per property (times number of properties)</td><td></td></tr> <tr><td>1809</td><td>770</td><td>2809</td><td>385</td><td>Filing a submission after final rejection (37 CFR § 1.129(a))</td><td></td></tr> <tr><td>1810</td><td>770</td><td>2810</td><td>385</td><td>For each additional invention to be examined (37 CFR § 1.129(b))</td><td></td></tr> <tr><td>1801</td><td>770</td><td>2801</td><td>385</td><td>Request for Continued Examination (RCE)</td><td></td></tr> <tr><td>1802</td><td>900</td><td>1802</td><td>900</td><td>Request for expedited examination of a design application</td><td></td></tr> <tr><td colspan="6">Other fee (specify) _____</td></tr> <tr> <td colspan="4"> <b>SUBTOTAL (1)</b>      \$ 385.00                     </td> <td colspan="2"> <b>SUBTOTAL (3)</b>      \$ 120.00                     </td> </tr> <tr> <td colspan="6"> <b>2. EXTRA CLAIM FEES</b>  <table border="1" style="width:100%"> <tr> <td>Total Claims</td> <td>32</td> <td>- 20 ** =</td> <td>12</td> <td>X</td> <td>9</td> <td>=</td> <td>108</td> </tr> <tr> <td>Independent Claims</td> <td>4</td> <td>- 3 ** =</td> <td>1</td> <td>X</td> <td>43</td> <td>=</td> <td>43</td> </tr> <tr> <td>Multiple Dependent</td> <td></td> <td></td> <td></td> <td>X</td> <td>145</td> <td>=</td> <td>0</td> </tr> </table>   <table border="1" style="width:100%"> <thead> <tr> <th colspan="2">Large Entity</th> <th colspan="2">Small Entity</th> <th rowspan="2">Fee Description</th> <th rowspan="2">Fee Paid</th> </tr> <tr> <th>Fee Code</th> <th>Fee (\$)</th> <th>Fee Code</th> <th>Fee (\$)</th> </tr> </thead> <tbody> <tr><td>1202</td><td>18</td><td>2202</td><td>9</td><td>Claims in excess of 20</td><td></td></tr> <tr><td>1201</td><td>86</td><td>2201</td><td>43</td><td>Independent claims in excess of 3</td><td></td></tr> <tr><td>1203</td><td>290</td><td>2203</td><td>145</td><td>Multiple dependent claim, if not paid</td><td></td></tr> <tr><td>1204</td><td>86</td><td>2204</td><td>43</td><td>** Reissue independent claims over original patent</td><td></td></tr> <tr><td>1205</td><td>18</td><td>2205</td><td>9</td><td>** Reissue claims in excess of 20 and over original patent</td><td></td></tr> </tbody> </table>   <b>SUBTOTAL (2)</b>      \$ 151.00                 </td> </tr> <tr> <td colspan="6">                     **or number previously paid, if greater; For Reissues, see above                 </td> </tr> </tbody> </table>	Large Entity		Small Entity		Fee Description	Fee Paid	Fee Code	Fee (\$)	Fee Code	Fee (\$)	1051	130	2051	65	Surcharge - late filing fee or oath	65	1052	50	2052	25	Surcharge - late provisional filing fee or cover sheet.		1053	130	1053	130	Non-English specification		1812	2,520	1812	2,520	For filing a request for reexamination		1804	920*	1804	920*	Requesting publication of SIR prior to Examiner action		1805	1,840*	1805	1,840*	Requesting publication of SIR after Examiner action		1251	110	2251	55	Extension for reply within first month	55	1252	420	2252	210	Extension for reply within second month		1253	950	2253	475	Extension for reply within third month		1254	1,480	2254	740	Extension for reply within fourth month		1255	2,010	2255	1,005	Extension for reply within fifth month		1401	330	2401	165	Notice of Appeal		1402	330	2402	165	Filing a brief in support of an appeal		1403	290	2403	145	Request for oral hearing		1451	1,510	1451	1,510	Petition to institute a public use proceeding		1452	110	2452	55	Petition to revive - unavoidable		1453	1,330	2453	665	Petition to revive - unintentional		1501	1,330	2501	665	Utility issue fee (or reissue)		1502	480	2502	240	Design issue fee		1503	640	2503	320	Plant issue fee		1460	130	1460	130	Petitions to the Commissioner		1807	50	1807	50	Processing fee under 37 CFR 1.17 (q)		1806	180	1806	180	Submission of Information Disclosure Stmt		8021	40	8021	40	Recording each patent assignment per property (times number of properties)		1809	770	2809	385	Filing a submission after final rejection (37 CFR § 1.129(a))		1810	770	2810	385	For each additional invention to be examined (37 CFR § 1.129(b))		1801	770	2801	385	Request for Continued Examination (RCE)		1802	900	1802	900	Request for expedited examination of a design application		Other fee (specify) _____						<b>SUBTOTAL (1)</b> \$ 385.00				<b>SUBTOTAL (3)</b> \$ 120.00		<b>2. EXTRA CLAIM FEES</b> <table border="1" style="width:100%"> <tr> <td>Total Claims</td> <td>32</td> <td>- 20 ** =</td> <td>12</td> <td>X</td> <td>9</td> <td>=</td> <td>108</td> </tr> <tr> <td>Independent Claims</td> <td>4</td> <td>- 3 ** =</td> <td>1</td> <td>X</td> <td>43</td> <td>=</td> <td>43</td> </tr> <tr> <td>Multiple Dependent</td> <td></td> <td></td> <td></td> <td>X</td> <td>145</td> <td>=</td> <td>0</td> </tr> </table> <table border="1" style="width:100%"> <thead> <tr> <th colspan="2">Large Entity</th> <th colspan="2">Small Entity</th> <th rowspan="2">Fee Description</th> <th rowspan="2">Fee Paid</th> </tr> <tr> <th>Fee Code</th> <th>Fee (\$)</th> <th>Fee Code</th> <th>Fee (\$)</th> </tr> </thead> <tbody> <tr><td>1202</td><td>18</td><td>2202</td><td>9</td><td>Claims in excess of 20</td><td></td></tr> <tr><td>1201</td><td>86</td><td>2201</td><td>43</td><td>Independent claims in excess of 3</td><td></td></tr> <tr><td>1203</td><td>290</td><td>2203</td><td>145</td><td>Multiple dependent claim, if not paid</td><td></td></tr> <tr><td>1204</td><td>86</td><td>2204</td><td>43</td><td>** Reissue independent claims over original patent</td><td></td></tr> <tr><td>1205</td><td>18</td><td>2205</td><td>9</td><td>** Reissue claims in excess of 20 and over original patent</td><td></td></tr> </tbody> </table> <b>SUBTOTAL (2)</b> \$ 151.00						Total Claims	32	- 20 ** =	12	X	9	=	108	Independent Claims	4	- 3 ** =	1	X	43	=	43	Multiple Dependent				X	145	=	0	Large Entity		Small Entity		Fee Description	Fee Paid	Fee Code	Fee (\$)	Fee Code	Fee (\$)	1202	18	2202	9	Claims in excess of 20		1201	86	2201	43	Independent claims in excess of 3		1203	290	2203	145	Multiple dependent claim, if not paid		1204	86	2204	43	** Reissue independent claims over original patent		1205	18	2205	9	** Reissue claims in excess of 20 and over original patent		**or number previously paid, if greater; For Reissues, see above					
Large Entity		Small Entity		Fee Description	Fee Paid																																																																																																																																																																																																																																																																						
Fee Code	Fee (\$)	Fee Code	Fee (\$)																																																																																																																																																																																																																																																																								
1051	130	2051	65	Surcharge - late filing fee or oath	65																																																																																																																																																																																																																																																																						
1052	50	2052	25	Surcharge - late provisional filing fee or cover sheet.																																																																																																																																																																																																																																																																							
1053	130	1053	130	Non-English specification																																																																																																																																																																																																																																																																							
1812	2,520	1812	2,520	For filing a request for reexamination																																																																																																																																																																																																																																																																							
1804	920*	1804	920*	Requesting publication of SIR prior to Examiner action																																																																																																																																																																																																																																																																							
1805	1,840*	1805	1,840*	Requesting publication of SIR after Examiner action																																																																																																																																																																																																																																																																							
1251	110	2251	55	Extension for reply within first month	55																																																																																																																																																																																																																																																																						
1252	420	2252	210	Extension for reply within second month																																																																																																																																																																																																																																																																							
1253	950	2253	475	Extension for reply within third month																																																																																																																																																																																																																																																																							
1254	1,480	2254	740	Extension for reply within fourth month																																																																																																																																																																																																																																																																							
1255	2,010	2255	1,005	Extension for reply within fifth month																																																																																																																																																																																																																																																																							
1401	330	2401	165	Notice of Appeal																																																																																																																																																																																																																																																																							
1402	330	2402	165	Filing a brief in support of an appeal																																																																																																																																																																																																																																																																							
1403	290	2403	145	Request for oral hearing																																																																																																																																																																																																																																																																							
1451	1,510	1451	1,510	Petition to institute a public use proceeding																																																																																																																																																																																																																																																																							
1452	110	2452	55	Petition to revive - unavoidable																																																																																																																																																																																																																																																																							
1453	1,330	2453	665	Petition to revive - unintentional																																																																																																																																																																																																																																																																							
1501	1,330	2501	665	Utility issue fee (or reissue)																																																																																																																																																																																																																																																																							
1502	480	2502	240	Design issue fee																																																																																																																																																																																																																																																																							
1503	640	2503	320	Plant issue fee																																																																																																																																																																																																																																																																							
1460	130	1460	130	Petitions to the Commissioner																																																																																																																																																																																																																																																																							
1807	50	1807	50	Processing fee under 37 CFR 1.17 (q)																																																																																																																																																																																																																																																																							
1806	180	1806	180	Submission of Information Disclosure Stmt																																																																																																																																																																																																																																																																							
8021	40	8021	40	Recording each patent assignment per property (times number of properties)																																																																																																																																																																																																																																																																							
1809	770	2809	385	Filing a submission after final rejection (37 CFR § 1.129(a))																																																																																																																																																																																																																																																																							
1810	770	2810	385	For each additional invention to be examined (37 CFR § 1.129(b))																																																																																																																																																																																																																																																																							
1801	770	2801	385	Request for Continued Examination (RCE)																																																																																																																																																																																																																																																																							
1802	900	1802	900	Request for expedited examination of a design application																																																																																																																																																																																																																																																																							
Other fee (specify) _____																																																																																																																																																																																																																																																																											
<b>SUBTOTAL (1)</b> \$ 385.00				<b>SUBTOTAL (3)</b> \$ 120.00																																																																																																																																																																																																																																																																							
<b>2. EXTRA CLAIM FEES</b> <table border="1" style="width:100%"> <tr> <td>Total Claims</td> <td>32</td> <td>- 20 ** =</td> <td>12</td> <td>X</td> <td>9</td> <td>=</td> <td>108</td> </tr> <tr> <td>Independent Claims</td> <td>4</td> <td>- 3 ** =</td> <td>1</td> <td>X</td> <td>43</td> <td>=</td> <td>43</td> </tr> <tr> <td>Multiple Dependent</td> <td></td> <td></td> <td></td> <td>X</td> <td>145</td> <td>=</td> <td>0</td> </tr> </table> <table border="1" style="width:100%"> <thead> <tr> <th colspan="2">Large Entity</th> <th colspan="2">Small Entity</th> <th rowspan="2">Fee Description</th> <th rowspan="2">Fee Paid</th> </tr> <tr> <th>Fee Code</th> <th>Fee (\$)</th> <th>Fee Code</th> <th>Fee (\$)</th> </tr> </thead> <tbody> <tr><td>1202</td><td>18</td><td>2202</td><td>9</td><td>Claims in excess of 20</td><td></td></tr> <tr><td>1201</td><td>86</td><td>2201</td><td>43</td><td>Independent claims in excess of 3</td><td></td></tr> <tr><td>1203</td><td>290</td><td>2203</td><td>145</td><td>Multiple dependent claim, if not paid</td><td></td></tr> <tr><td>1204</td><td>86</td><td>2204</td><td>43</td><td>** Reissue independent claims over original patent</td><td></td></tr> <tr><td>1205</td><td>18</td><td>2205</td><td>9</td><td>** Reissue claims in excess of 20 and over original patent</td><td></td></tr> </tbody> </table> <b>SUBTOTAL (2)</b> \$ 151.00						Total Claims	32	- 20 ** =	12	X	9	=	108	Independent Claims	4	- 3 ** =	1	X	43	=	43	Multiple Dependent				X	145	=	0	Large Entity		Small Entity		Fee Description	Fee Paid	Fee Code	Fee (\$)	Fee Code	Fee (\$)	1202	18	2202	9	Claims in excess of 20		1201	86	2201	43	Independent claims in excess of 3		1203	290	2203	145	Multiple dependent claim, if not paid		1204	86	2204	43	** Reissue independent claims over original patent		1205	18	2205	9	** Reissue claims in excess of 20 and over original patent																																																																																																																																																																																																							
Total Claims	32	- 20 ** =	12	X	9	=	108																																																																																																																																																																																																																																																																				
Independent Claims	4	- 3 ** =	1	X	43	=	43																																																																																																																																																																																																																																																																				
Multiple Dependent				X	145	=	0																																																																																																																																																																																																																																																																				
Large Entity		Small Entity		Fee Description	Fee Paid																																																																																																																																																																																																																																																																						
Fee Code	Fee (\$)	Fee Code	Fee (\$)																																																																																																																																																																																																																																																																								
1202	18	2202	9	Claims in excess of 20																																																																																																																																																																																																																																																																							
1201	86	2201	43	Independent claims in excess of 3																																																																																																																																																																																																																																																																							
1203	290	2203	145	Multiple dependent claim, if not paid																																																																																																																																																																																																																																																																							
1204	86	2204	43	** Reissue independent claims over original patent																																																																																																																																																																																																																																																																							
1205	18	2205	9	** Reissue claims in excess of 20 and over original patent																																																																																																																																																																																																																																																																							
**or number previously paid, if greater; For Reissues, see above																																																																																																																																																																																																																																																																											

<b>SUBMITTED BY</b>			Complete (if applicable)		
Name (Print/Type)	Craig J. Madson	Registration No. Attorney/Agent)	29,407	Telephone	801-537-1700
Signature				Date	August 18, 2004

**WARNING: Information on this form may become public. Credit card information should not be included on this form. Provide credit card information and authorization on PTO-2038.**

This collection of information is required by 37 CFR 1.17 and 1.27. The information is required to obtain or retain a benefit by the public which is to file (and by the USPTO to process) an application. Confidentiality is governed by 35 U.S.C. 122 and 37 CFR 1.14. This collection is estimated to take 12 minutes to complete, including gathering, preparing, and submitting the completed application form to the USPTO. Time will vary depending upon the individual case. Any comments on the amount of time you are required to complete this form and/or suggestions for reducing this burden, should be sent to the Chief Information Officer, U.S. Patent and Trademark Office, U.S. Department of Commerce, P.O. Box 1450, Alexandria, VA 22313-1450. DO NOT SEND FEES OR COMPLETED FORMS TO THIS ADDRESS. SEND TO: Commissioner for Patents, P.O. Box 1450, Alexandria, VA 22313-1450.

If you need assistance in completing this form, call 1-800-PTO-9199 and selection option 2.



CERTIFICATE OF MAILING

I hereby certify that this correspondence is being deposited with the United States Postal Service as first class mail in an envelope addressed to: Mail Stop Missing Parts, Commissioner for Patents, P.O. Box 1450, Alexandria, VA 22313-1450, on August 18, 2004.

*Craig Madison*  
Attorney for Applicant(s)

IN THE UNITED STATES PATENT AND TRADEMARK OFFICE

Appl. No. : 10/733,853  
Applicant : Lyman O. Nielson et al.  
Title : LOW-VOLTAGE LIGHTING APPARATUS FOR SATISFYING AFTER-HOURS LIGHTING REQUIREMENTS, EMERGENCY LIGHTING REQUIREMENTS, AND LOW LIGHT REQUIREMENTS  
Filed : December 11, 2003  
TC/A.U. : 2875  
Examiner : (not yet assigned)  
Docket No. : 3358.2.1  
Customer No. : 21552

Mail Stop Missing Parts  
Commissioner for Patent  
P.O. Box 1450  
Alexandria, VA 22313-1450

**RESPONSE TO NOTICE TO FILE MISSING PARTS OF APPLICATION--FILING DATE GRANTED**

Dear Sir:

In response to the Notice to File Missing Parts of Nonprovisional Application mailed May 18, 2004, enclosed please find the following items for filing in the United States Patent and Trademark Office in connection with the above-identified patent application:

- (1) Declaration, and Petition;
- (2) Power of Attorney by Assignee
- (3) Letter to Official Draftsperson;



- (4) 5 Sheets of Drawings
- (5) Fee Transmittal Form;
- (6) Petition for Extension of Time, 1 month;
- (7) Credit Card Payment Form in the amount of \$601.00 to cover the utility application filing fee; the surcharge fee pursuant to 37 C.F.R. § 1.16(e);
- (8) Credit Card Payment Form in the amount of \$55.00 for 1 Month Extension Petition Fee; and
- (9) a copy of the Notice to File Missing Parts of Application - Filing Date Granted.

Please debit any additional fees, or credit any over payment, to Deposit Account No. 13-0763. A duplicate copy of this sheet is enclosed.

Please address all future correspondence in connection with this application to the attention of the undersigned.

Respectfully submitted,

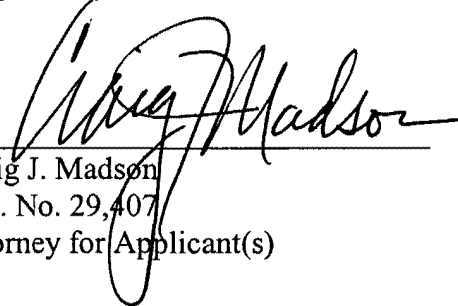
  
\_\_\_\_\_  
Craig J. Madson  
Reg. No. 29,407  
Attorney for Applicant(s)

Date: August 18, 2004

MADSON & METCALF  
Gateway Tower West  
15 West South Temple, Suite 900  
Salt Lake City, Utah 84101  
Telephone: 801/537-1700



CERTIFICATE OF MAILING

Hereby certify that this correspondence is being deposited with the United States Postal Service as first class mail in an envelope addressed to: Mail Stop Missing Parts, Commissioner for Patents, P.O. Box 1450, Alexandria, VA 22313-1450, on August 18, 2004.

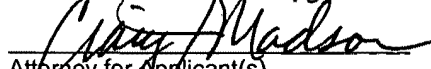
  
Attorney for Applicant(s)

IN THE UNITED STATES PATENT AND TRADEMARK OFFICE

Appl. No. : 10/733,853  
Applicant : Lyman O. Nielson et al.  
Title : LOW-VOLTAGE LIGHTING APPARATUS FOR SATISFYING AFTER-HOURS LIGHTING REQUIREMENTS, EMERGENCY LIGHTING REQUIREMENTS, AND LOW LIGHT REQUIREMENTS  
Filed : December 11, 2003  
TC/A.U. : 2875  
Examiner : (not yet assigned)  
Docket No. : 3358.2.1  
Customer No. : 21552

Mail Stop Missing Parts  
Commissioner for Patents  
P.O. Box 1450  
Alexandria, VA 22313-1450

**LETTER TO OFFICIAL DRAFTSPERSON**

Dear Sir:

In response to the Notice to File Missing Parts dated May 18, 2004, issued in connection with the above-referenced case, Applicant submits herewith substitute Figures 1-6 (5 sheets) making the changes required by the draftsman.

Respectfully submitted,

  
\_\_\_\_\_  
Craig J. Madson  
Reg. No. 29,407  
Attorney for Applicant(s)

Date: August 18, 2004  
MADSON & METCALF  
Gateway Tower West  
15 West South Temple, Suite 900  
Salt Lake City, Utah 84101  
Telephone: 801/537-1700

## PETITION FOR EXTENSION OF TIME UNDER 37 CFR 1.136(a)

Docket Number (Optional)  
3358.2.1

In re Application of Lyman O. Nielson

Application Number 10/733,853

Filed December 11, 2003

For LOW-VOLTAGE LIGHTING APPARATUS FOR SATISFYING AFTER-HOURS LIGHTING REQUIREMENTS, EMERGENCY LIGHTING REQUIREMENTS, AND LOW LIGHT REQUIREMENTS

Group Art Unit  
2875

Examiner

This is a request under the provisions of 37 CFR 1.136(a) to extend the period for filing a response in the above identified application.

The requested extension and appropriate non-small-entity fee are as follows (check time period desired):

- One month (37 CFR 1.17(a)(1)) \$ 110.00
- Two months (37 CFR 1.17(a)(2)) \$ 420.00
- Three months (37 CFR 1.17(a)(3)) \$ 950.00
- Four months (37 CFR 1.17(a)(4)) \$ 1480.00
- Five months (37 CFR 1.17(a)(5)) \$ 2010.00
- Applicant claims small entity status. See 37 CFR 1.27. Therefore, the fee amount shown above is reduced by one-half, and the resulting fee is: \$ 55.00.
- A check in the amount of the fee is enclosed.
- Payment by credit card. Form PTO-2038 is attached.
- The Commissioner has already been authorized to charge fees in this application to a Deposit Account.
- The Commissioner is hereby authorized to charge any underpayment of the above fees, or credit any overpayment, to Deposit Account Number 13-0763.

I have enclosed a duplicate copy of this sheet.

I am the  applicant/inventor.

assignee of record of the entire interest. See 37 CFR 3.71

Statement under 37 CFR 3.73(b) is enclosed. (Form PTO/SB/96).

attorney or agent of record.

08/24/2004 DTESSEM1 00000034 10733853

attorney or agent under 37 CFR 1.34(a).

05 FC:2251

55.00 OP

Registration number if acting under 37 CFR 1.34(a). \_\_\_\_\_

**WARNING: Information on this form may become public. Credit card information should not be included on this form. Provide credit card information and authorization on PTO-2038.**

August 18, 2004

Date

(801) 537-1700

Telephone Number

Signature

Craig J. Madson

Typed or printed name

NOTE: Signatures of all the inventors or assignees of record of the entire interest or their representative(s) are required. Submit multiple forms if more than one signature is required, see below\*.

\*Total of 1 forms are submitted.

This collection of information is required by 37 CFR 1.136(a). The information is required to obtain or retain a benefit by the public which is to file (and by the USPTO to process) an application. Confidentiality is governed by 35 U.S.C. 122 and 37 CFR 1.14. This collection is estimated to take 6 minutes to complete, including gathering, preparing, and submitting the completed application form to the USPTO. Time will vary depending upon the individual case. Any comments on the amount of time you are required to complete this form and/or suggestions for reducing this burden, should be sent to the Chief Information Officer, U.S. Patent and Trademark Office, U.S. Department of Commerce, P.O. Box 1450, Alexandria, VA 22313-1450. DO NOT SEND FEES OR COMPLETED FORMS TO THIS ADDRESS. SEND TO: Commissioner for Patents, P.O. Box 1450, Alexandria, VA 22313-1450.

If you need assistance in completing this form, call 1-800-PTO-9199 and selection option 2.



PATENT APPLICATION  
Docket No.: 3358.2.1

**DECLARATION AND PETITION**

We, Lyman O. Nielson and Norman B. Hess, whose residences, post office addresses, and citizenships are as stated below next to our names; verily believe we are the original, first, and joint inventors of the subject matter of the invention or discovery entitled LOW-VOLTAGE LIGHTING APPARATUS FOR SATISFYING AFTER-HOURS LIGHTING REQUIREMENTS, EMERGENCY LIGHTING REQUIREMENTS, AND LOW LIGHT REQUIREMENTS, the specification of which was filed on December 11, 2003 as United States Application Number 10/733,853; that we have reviewed and understand the contents of the above-identified specification, including the claims; and that we acknowledge the duty to disclose all information known to us to be material to patentability as defined in Section 1.56 of Title 37 of the Code of Federal Regulations.

We declare further that all statements made herein of our own knowledge are true and that all statements made on information and belief are believed to be true; and further that these statements were made with the knowledge that willful, false statements and the like so made are punishable by fine or imprisonment, or both, under Section 1001 of Title 18 of the United States Code, and that such willful, false statements may jeopardize the validity of the application or any patent issuing thereon.

Wherefore, we pray that Letters Patent be granted to us for the invention or discovery described and claimed in the foregoing specification and claims, declaration and this petition.

Signed at Bountiful, Utah, this 30th day of July, 2004.  
(City) (State)

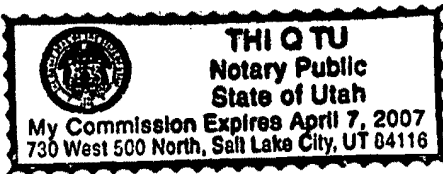

Inventor Lyman O. Nielson  
Lyman O. Nielson  
1241 East 960 South  
Fruit Heights, Utah 84037  
Nationality: United States



Signed at Fruit Heights, Utah, this 26 day of  
July (City) (State), 2004.

Inventor 

Norman B. Hess  
1073 East Pheasant View Drive  
Fruit Heights, Utah 84037  
Nationality: United States

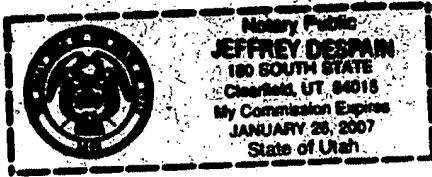

expires 1/26/07

Jeffrey Despain  
wells Fargo  
7/26/04



**IN THE UNITED STATES PATENT AND TRADEMARK OFFICE**

Application of: ) PATENT APPLICATION  
)  
Inventors: Nielson et al. )  
)  
Serial No.: 10/733,853 )  
) Attorney Docket No.  
Filed: December 11, 2003 ) 3358.2.1  
)  
For: LOW-VOLTAGE LIGHTING )  
APPARATUS FOR SATISFYING )  
AFTER-HOURS LIGHTING )  
REQUIREMENTS, EMERGENCY )  
LIGHTING REQUIREMENTS, AND )  
LOW LIGHT REQUIREMENTS )

---

**POWER OF ATTORNEY BY ASSIGNEE**

SAFEexits, Inc., a corporation of the State of Utah, Assignee of the entire right, title and interest in and to the above-identified patent application, hereby appoints those individuals associated with U.S. Patent and Trademark Office Customer No. 21552, with full power of substitution and revocation, to prosecute this application and to transact all business in the Patent and Trademark Office connected therewith. All correspondence and telephonic communications should be directed to Craig J. Madson at the address associated with Customer No. 21552.

Pursuant to 37 C.F.R. §3.73(b) the undersigned submits herewith a copy of an assignment document from the inventors to Assignee. The assignment document has previously been submitted to the Patent and Trademark Office for recordation. The assignment has been reviewed and, to the best of the undersigned's knowledge and belief,

title is in the Assignee. The undersigned, whose title is supplied below, is empowered to sign this Power of Attorney on behalf of the Assignee.

Assignee:

SAFEexits, Inc.

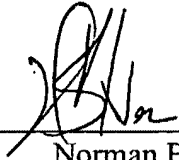

By: Norman B. Hess  
Title: President

Date: 26 July 04

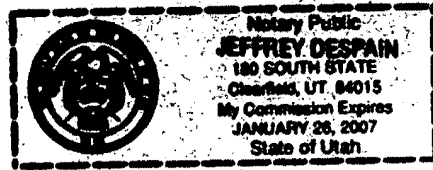

Jeffrey Despain  
Wells Fargo  
7/26/04

expires 1/26/07



Title: Low-Voltage Lighting Apparatus For Satisfying After-Hours Lighting Requirements, Emergency Lighting Requirements, and Low Light Requirements

Inventors: Lyman O. Nielson and Norman B. Hess

Docket No.: 3358.2.1

1/5

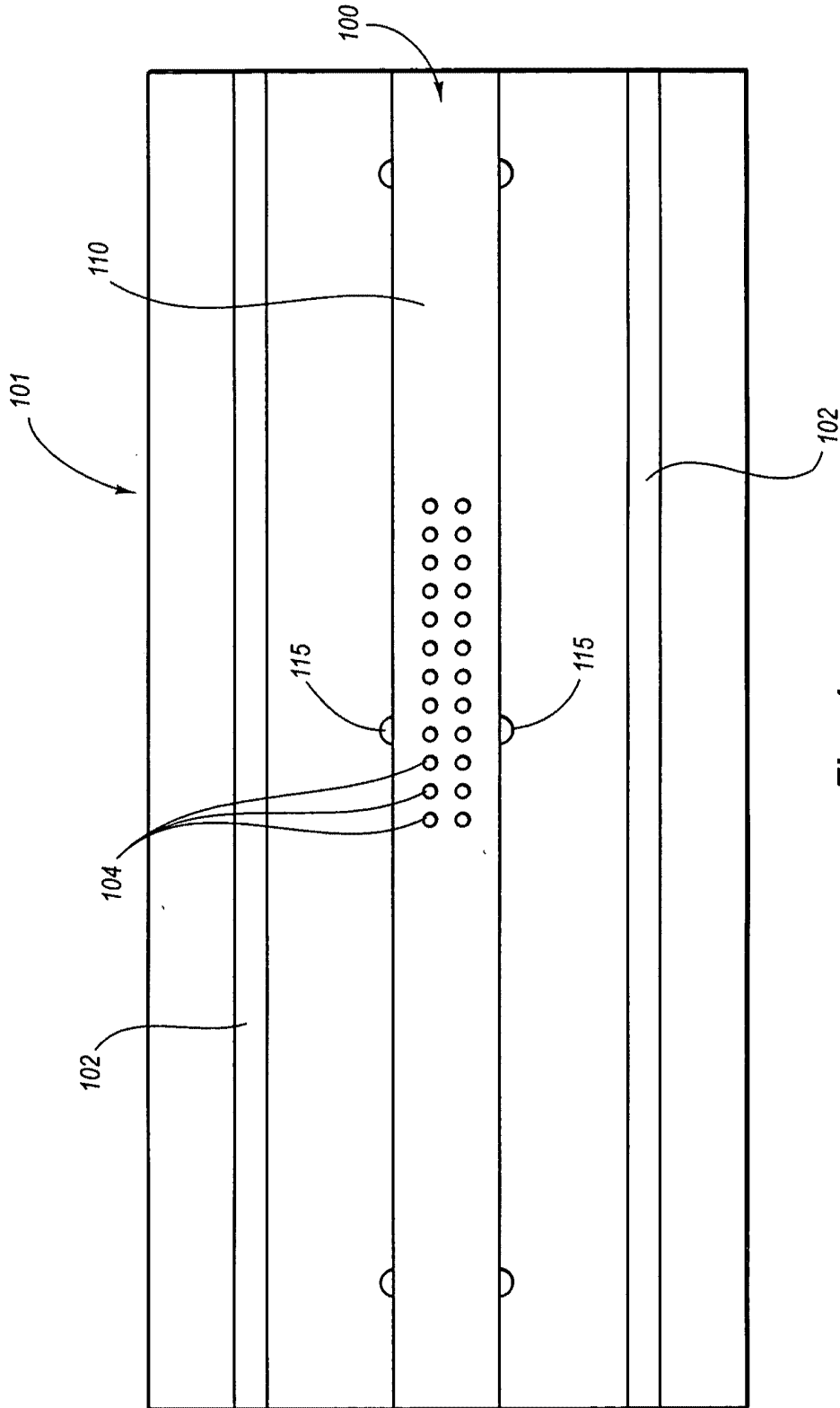

Fig. 1

Title: Low-Voltage Lighting Apparatus For Satisfying After-Hours Lighting Requirements, Emergency Lighting Requirements, and Low Light Requirements

Inventors: Lyman O. Nielson and Norman B. Hess

Docket No.: 3358.2.1

2 / 5

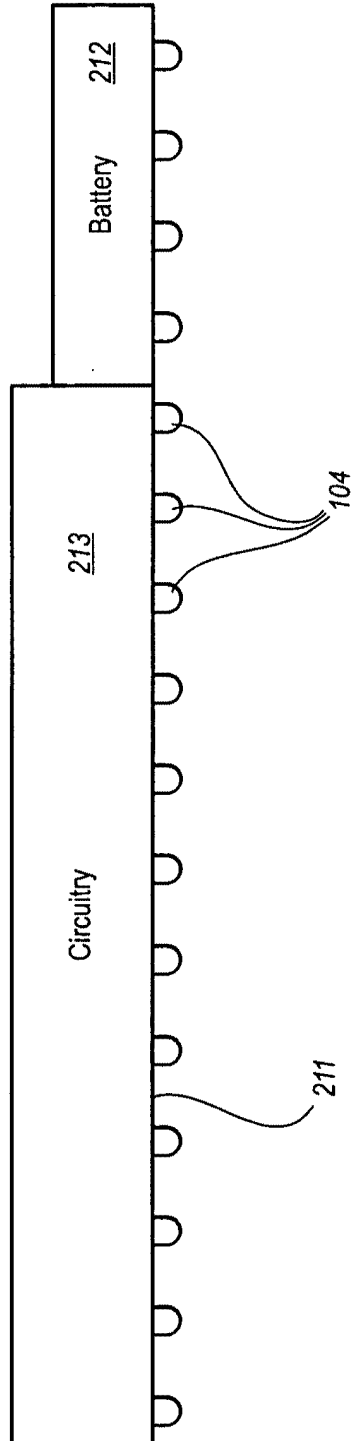

Fig. 2

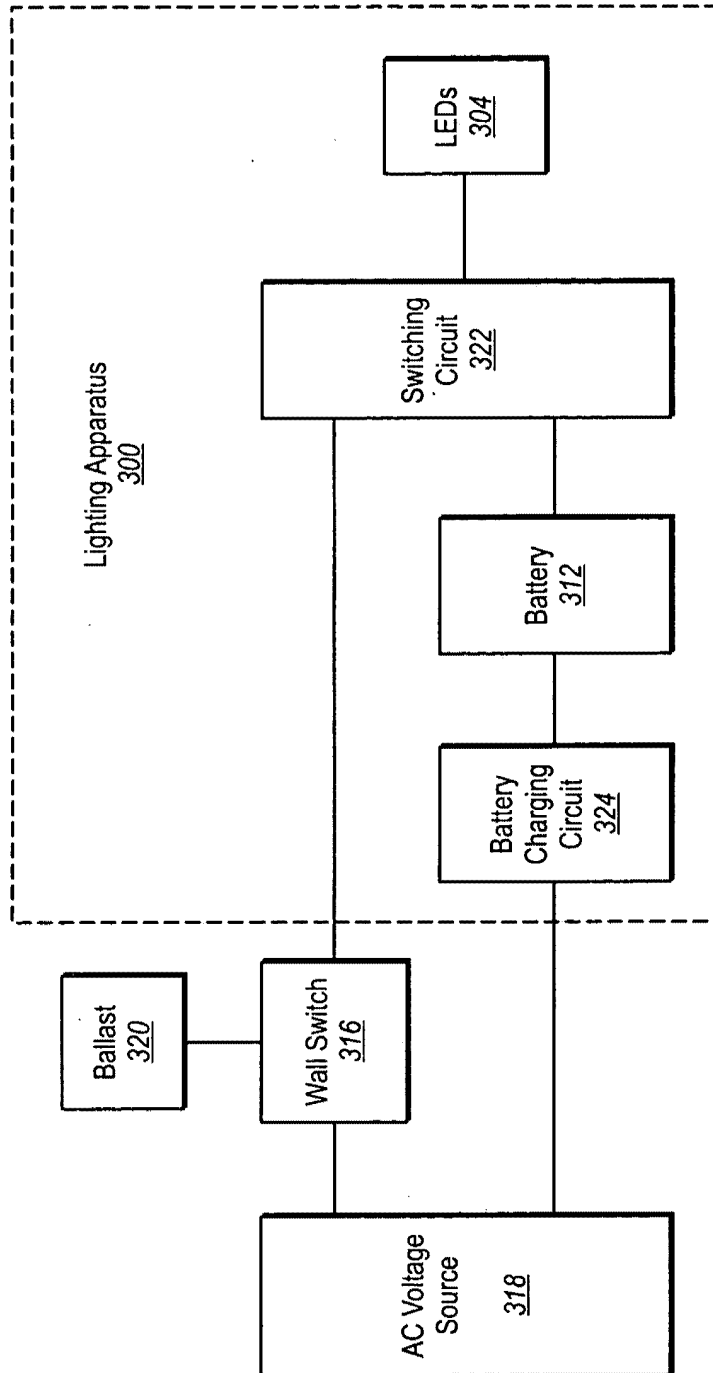

Fig. 3

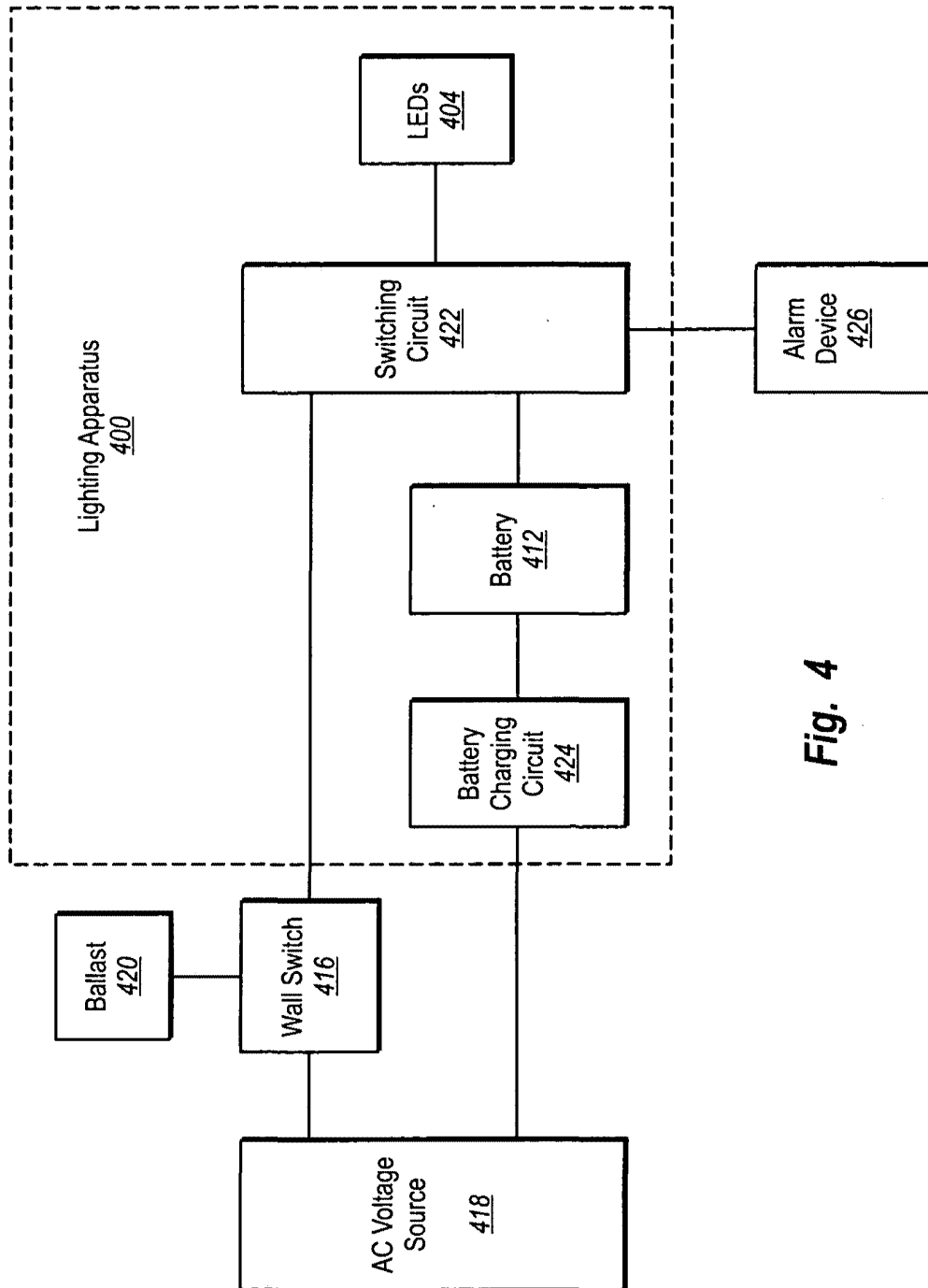

Fig. 4

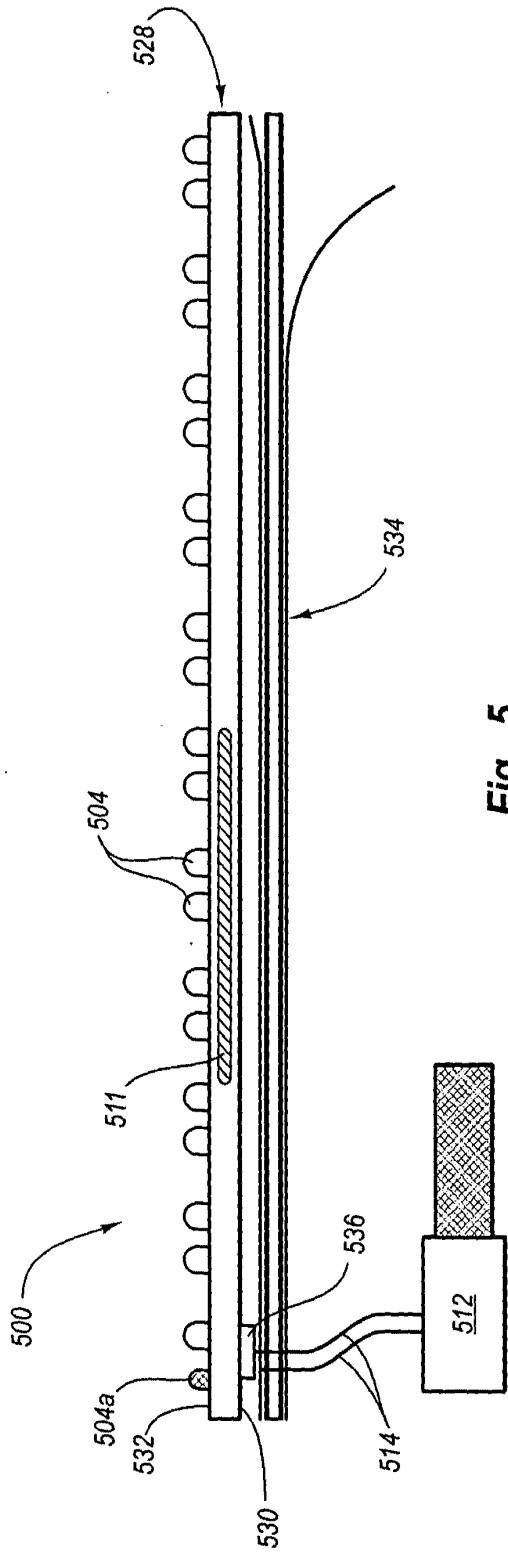

Fig. 5

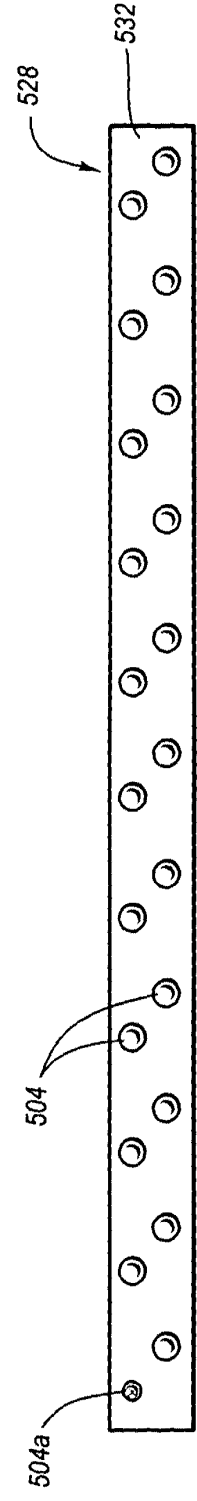

Fig. 6



Ref #	Hits	Search Query	DBs	Default Operator	Plurals	Time Stamp
S1	45	US-4255746-\$.DID. OR US-4419658-\$.DID. OR US-4454452-\$.DID. OR US-4617561-\$.DID. OR US-D290406-\$.DID. OR US-4945280-\$.DID. OR US-4977351-\$.DID. OR US-5130909-\$.DID. OR US-5146209-\$.DID. OR US-5145247-\$.DID. OR US-5365145-\$.DID. OR US-5416384-\$.DID. OR US-5587705-\$.DID. OR US-5731759-\$.DID. OR US-5739639-\$.DID. OR US-5786767-\$.DID. OR US-5936532-\$.DID. OR US-6133839-\$.DID. OR US-6249221-\$.DID. OR US-6384724-\$.DID. OR US-6420973-\$.DID. OR US-6609804-\$.DID. OR US-6624750-\$.DID.	US-PGPUB; USPAT; USOCR; EPO; JPO; DERWENT	OR	OFF	2005/04/17 18:17
S2	421	ballast and circuit adj board and (light adj emitting adj diode\$2 or led\$2)	US-PGPUB; USPAT; USOCR; EPO; JPO; DERWENT	OR	OFF	2005/04/05 11:32
S3	332	ballast and circuit adj board and (light adj emitting adj diode\$2 or led\$2) and @ad<"20021211"	US-PGPUB; USPAT; USOCR; EPO; JPO; DERWENT	OR	OFF	2005/04/05 11:49
S4	143	ballast and circuit adj board and (light adj emitting adj diode\$2 or led\$2) and cover and @ad<"20021211"	US-PGPUB; USPAT; USOCR; EPO; JPO; DERWENT	OR	OFF	2005/04/05 11:49
S5	24	("20020060526"   "2713629"   "3714414"   "3755663"   "4152618"   "4521835"   "4581687"   "4665470"   "4748545"   "4901207"   "4941072"   "4943900"   "5032960"   "5515253"   "5688042"   "5810463"   "6068383"   "6139174"   "6283612"   "6331915"   "6388393"   "6583550"   "6682205").PN.	US-PGPUB; USPAT; USOCR	OR	OFF	2005/04/05 13:27

S6	6	("6158882"   "6283612"   "6354714"   "6394623"   "6478449"   "6565251").PN.	US-PGPUB; USPAT; USOCR	OR	OFF	2005/04/05 13:28
S7	221	(light adj emitting adj diode\$2) and ballast and circuit adj board	US-PGPUB; USPAT; USOCR; EPO; JPO; DERWENT	OR	OFF	2005/04/05 13:31
S8	166	(light adj emitting adj diode\$2) and ballast and circuit adj board and @ad<"20021211"	US-PGPUB; USPAT; USOCR; EPO; JPO; DERWENT	OR	OFF	2005/04/05 13:31
S9	0	nielson-lyman.in.	US-PGPUB; USPAT; USOCR; EPO; JPO; DERWENT	OR	OFF	2005/04/05 13:32
S10	0	hess-norman.in.	US-PGPUB; USPAT; USOCR; EPO; JPO; DERWENT	OR	OFF	2005/04/05 13:31
S11	22	hess.in. and "362".clas.	US-PGPUB; USPAT; USOCR; EPO; JPO; DERWENT	OR	OFF	2005/04/05 13:32
S12	6	nielson.in. and "362".clas.	US-PGPUB; USPAT; USOCR; EPO; JPO; DERWENT	OR	OFF	2005/04/05 13:32
S13	33	("2476517"   "2715197"   "2946903"   "3032688"   "3422309"   "3500455"   "3659179"   "3935505"   "4349863"   "4727291"   "4733335"   "4985661"   "5655830"   "5734229"   "5752766"   "5848837"   "6016038"   "6149283"   "6163038"   "6203180"   "6218785"   "6220722"   "6227679"   "6250774"   "6268801"   "6367949"   "6431728").PN.	US-PGPUB; USPAT; USOCR	OR	OFF	2005/04/05 13:38
S14	5	("4673844"   "5023521"   "5111115"   "5854542"   "6043615").PN.	US-PGPUB; USPAT; USOCR	OR	OFF	2005/04/05 13:40

S15	30	362/20.ccls. and @ad<"20021211" and (light adj emitting adj diode\$2 or led\$2) and circuit adj board	US-PGPUB; USPAT; USOCR	OR	OFF	2005/04/05 13:51
S16	165	362/249.ccls. and @ad<"20021211" and (light adj emitting adj diode\$2 or led\$2) and circuit adj board	US-PGPUB; USPAT; USOCR	OR	OFF	2005/04/05 13:51
S17	3	362/249.ccls. and @ad<"20021211" and (light adj emitting adj diode\$2 or led\$2) and circuit adj board and ballast	US-PGPUB; USPAT; USOCR	OR	OFF	2005/04/05 13:52
S18	7	362/183.ccls. and @ad<"20021211" and (light adj emitting adj diode\$2 or led\$2) and circuit adj board and ballast	US-PGPUB; USPAT; USOCR	OR	OFF	2005/04/05 13:52
S19	8	362/276.ccls. and @ad<"20021211" and (light adj emitting adj diode\$2 or led\$2) and circuit adj board and ballast	US-PGPUB; USPAT; USOCR	OR	OFF	2005/04/05 13:54
S20	1	362/394.ccls. and @ad<"20021211" and (light adj emitting adj diode\$2 or led\$2) and circuit adj board and ballast	US-PGPUB; USPAT; USOCR	OR	OFF	2005/04/05 13:54
S21	1	362/147-148.ccls. and @ad<"20021211" and (light adj emitting adj diode\$2 or led\$2) and circuit adj board and ballast	US-PGPUB; USPAT; USOCR	OR	OFF	2005/04/05 13:54
S22	2	362/559.ccls. and @ad<"20021211" and (light adj emitting adj diode\$2 or led\$2) and circuit adj board and ballast	US-PGPUB; USPAT; USOCR	OR	OFF	2005/04/05 13:54

S23	117	("3701043"   "3863075"   "3889147"   "4149111"   "4189720"   "4243985"   "4283657"   "4298806"   "4301461"   "4319306"   "4342944"   "4390931"   "4417235"   "4422069"   "4450436"   "4489308"   "4524304"   "4531114"   "4598198"   "4612535"   "4615131"   "4617555"   "4630180"   "4630183"   "4633280"   "4649376"   "4654629"   "4703219"   "4716296"   "4720835"   "4763115"   "4799135"   "4801928"   "4918497"   "4929866"   "4935665"   "4954822"   "4965644"   "4966862"   "4990970"   "5027168"   "5045767"   "5050055"   "5093768"   "5097397"   "5097612"   "5101326"   "5122943"   "5136287"   "5177461"   "5187547"   "5220235"   "5233204"   "5235498"   "5283425"   "5313187"   "5321593"   "5357123"   "5357409"   "5359255"   "5362971"   "5403916"   "5406095"   "5419065"   "5420444"   "5475241"   "5482896"   "5491350"   "5498883"   "5514627"   "5516727"   "5519720"   "5526237"   "5528474"   "5567036"   "5569939"   "5575459"   "5580156"   "5585783"   "5593223"   "5612231"   "5625201"   "5627851"   "5631474"   "5632551"   "5634711"   "5636916"   "5656829"   "5661742"   "5674000"   "5694112"   "5697175"   "5705047"   "5707891"   "5739552"   "5739592"   "5758947"   "5760531"   "5785418"   "5789768"   "5793062"   "5804822"   "5806965"   "5838024"   "5838247"   "5848837"   "5929788"   "5931562"   "5975714"   "6009650"   "6018899"   "6028694"   "6095661"   "6102696"   "6159005"   "6179678"   "6324921"   ".PN."	US-PGPUB; USPAT; USOCR	OR	OFF	2005/04/05 13:56
Search History 4/18/05 6:43:49 PM Page 4 C:\Documents and Settings\jhan11\My Documents\EAST\Workspaces\10733853.wsp (324921).PN.						

S24	1380	ballast same cover same (hole\$2 or aperture\$2 or opening\$2)	US-PGPUB; USPAT; USOCR	OR	OFF	2005/04/05 13:56
S25	10	ballast same cover same (hole\$2 or aperture\$2 or opening\$2) and light adj emitting adj diode\$2	US-PGPUB; USPAT; USOCR	OR	OFF	2005/04/05 13:57
S26	2	("6167648").URPN.	USPAT	OR	OFF	2005/04/05 13:58
S27	11	("1761120"   "2519302"   "3309806"   "3783542"   "5459955"   "5697175"   "5722760"   "6042248").PN.	US-PGPUB; USPAT; USOCR	OR	OFF	2005/04/05 13:58
S28	2	("6167648").URPN.	USPAT	OR	OFF	2005/04/05 13:59
S29	14	("1875956"   "3535506"   "4177500"   "4357648"   "4432043"   "4590543"   "4611264"   "4631649"   "4682078"   "4782432"   "4977489"   "5467258").PN.	US-PGPUB; USPAT; USOCR	OR	OFF	2005/04/05 13:59
S30	1	("RE36696").URPN.	USPAT	OR	OFF	2005/04/05 14:00
S31	54	("0844087"   "0859199"   "2915844"   "3309806"   "3324290"   "3560729"   "3864861"   "4139957"   "4211955"   "4234914"   "4254453"   "4259800"   "4271408"   "4298869"   "4345530"   "4383382"   "4425604"   "4435743"   "4443835"   "4630183"   "4682147"   "4720709"   "4724629"   "4727289"   "4768300"   "4782429"   "4849864"   "4884178"   "4929866"   "4951406"   "4965457"   "4967317"   "5012157"   "5014167"   "5018290"   "5020252"   "5036248"   "5105568"   "5136483"   "5160201"   "5186537"   "5253151"   "5268828"   "5276591"   "5299109"   "5303124"   "5365411"   "5416679"   "5448843").PN.	US-PGPUB; USPAT; USOCR	OR	OFF	2005/04/05 14:00
S32	19	("5526236").URPN.	USPAT	OR	OFF	2005/04/05 14:02

S33	49	("0844087"   "0859199"   "2915844"   "3309806"   "3324290"   "3560729"   "3864861"   "4139957"   "4211955"   "4234914"   "4254453"   "4259800"   "4271408"   "4298869"   "4345308"   "4383382"   "4435743"   "4443835"   "4630183"   "4682147"   "4720709"   "4724629"   "4727289"   "4768300"   "4782429"   "4849864"   "4884178"   "4929866"   "4951406"   "4965457"   "4967317"   "4991063"   "5012157"   "5018290"   "5020252"   "5036248"   "5105568"   "5136483"   "5160201"   "5268828"   "5276591"   "5299109"   "5303124"   "5410453").PN.	US-PGPUB; USPAT; USOCR	OR	OFF	2005/04/05 14:03
S34	10	("0739845"   "0849574"   "4953067"   "4965457"   "5018290"   "5160201"   "5268828"   "5303124").PN.	US-PGPUB; USPAT; USOCR	OR	OFF	2005/04/05 14:05
S35	25	("5416679").URPN.	USPAT	OR	OFF	2005/04/05 14:05
S36	19	("20020191386"   "2089226"   "2597680"   "3604916"   "4092528"   "4386391"   "4654629"   "4814667"   "4943900"   "5057985"   "5103382"   "5416679"   "5642934"   "5934798"   "6158882"   "6347880"   "6582103").PN.	US-PGPUB; USPAT; USOCR	OR	OFF	2005/04/05 14:06
S37	52	("4254453").URPN.	USPAT	OR	OFF	2005/04/05 14:08
S38	221	fluorescent and (light adj emitting diode\$2) and ballast and circuit adj board	USPAT	OR	OFF	2005/04/05 14:08
S39	3	"2001184933"	US-PGPUB; USPAT; USOCR; EPO; JPO; DERWENT	OR	OFF	2005/04/17 18:18
S40	1276	ballast and light adj emitting adj diode\$2	US-PGPUB; USPAT; USOCR; EPO; JPO; DERWENT	OR	OFF	2005/04/17 18:25

S42	82	ballast and light adj emitting adj diode\$2 and @ad<"20021211" and "362".clas.	US-PGPUB; USPAT; USOCR; EPO; JPO; DERWENT	OR	OFF	2005/04/17 18:25
S43	166	ballast and light adj emitting adj diode\$2 and @ad<"20021211" and circuit adj board	US-PGPUB; USPAT; USOCR; EPO; JPO; DERWENT	OR	OFF	2005/04/17 18:25
S44	148	ballast same light adj emitting adj diode\$2 and @ad<"20021211"	US-PGPUB; USPAT; USOCR; EPO; JPO; DERWENT	OR	OFF	2005/04/17 18:26
S45	1071	ballast and light adj emitting adj diode\$2 and @ad<"20021211"	US-PGPUB; USPAT; USOCR; EPO; JPO; DERWENT	OR	OFF	2005/04/18 12:49
S46	308	ballast and light adj emitting adj diode\$2 and @ad<"20021211" and ("313".clas. or "315".clas. or "362".clas. or "259".clas.)	US-PGPUB; USPAT; USOCR; EPO; JPO; DERWENT	OR	OFF	2005/04/18 12:50
S47	319	ballast and light adj emitting adj diode\$2 and @ad<"20021211" and ("313".clas. or "315".clas. or "362".clas. or "257".clas.)	US-PGPUB; USPAT; USOCR; EPO; JPO; DERWENT	OR	OFF	2005/04/18 12:50
S48	30	("3156841"   "3772559"   "4229780"   "4271621"   "4554619"   "4650265"   "4924368"   "4991070"   "5020252"   "5063486"   "5105568"   "5291379"   "5349508"   "5388357"   "5394314"   "5410454"   "5459955"   "5469347"   "5485145"   "5510965"   "5539623"   "5585694"   "5588738"   "5608288"   "5649759"   "5742497"   "5814938"   "5847550"   "6135620").PN.	US-PGPUB; USPAT; USOCR	OR	OFF	2005/04/18 13:01
S49	255	362/227-229.ccls. and @ad<"20021211"	US-PGPUB; USPAT; USOCR	OR	OFF	2005/04/18 13:02
S50	92	362/227-229.ccls. and @ad<"20021211" and (light adj emitting adj diode\$2 or led\$2)	US-PGPUB; USPAT; USOCR	OR	OFF	2005/04/18 14:07

S51	60	362/20.ccls. and @ad<"20021211" and (light adj emitting adj diode\$2 or led\$2)	US-PGPUB; USPAT; USOCR	OR	OFF	2005/04/18 14:08
S52	4	US-5548494-\$.DID. OR US-6158868-\$.DID. OR US-5573328-\$.DID. OR US-5043855-\$.DID.	US-PGPUB; USPAT; USOCR	OR	OFF	2005/04/18 14:10
S53	2	US-6045232-\$.DID. OR US-6158868-\$.DID.	US-PGPUB; USPAT; USOCR	OR	OFF	2005/04/18 14:10
S54	11	("2863038"   "3739226"   "4177500"   "4461974"   "4514789"   "4631649"   "4977351"   "5132596"   "5336977"   "5473517").PN.	US-PGPUB; USPAT; USOCR	OR	OFF	2005/04/18 14:13
S55	6	("6000807").URPN.	USPAT	OR	OFF	2005/04/18 14:13
S56	47	(US-20040100787-\$.did. or (US-4216410-\$ or US-4254453-\$ or US-4255746-\$ or US-4419658-\$ or US-4454452-\$ or US-4617561-\$ or US-4945280-\$ or US-4977351-\$ or US-5130909-\$ or US-5145247-\$ or US-5146209-\$ or US-5365145-\$ or US-5410453-\$ or US-5416384-\$ or US-5416679-\$ or US-5459955-\$ or US-5526236-\$ or US-5539623-\$ or US-5587705-\$ or US-5731759-\$ or US-5739639-\$ or US-5786767-\$ or US-5936532-\$ or US-6133839-\$ or US-6167648-\$ or US-6249221-\$.did. or (US-6367949-\$ or US-6384724-\$ or US-6420973-\$ or US-6570346-\$ or US-6609804-\$ or US-6624750-\$ or US-6682205-\$ or US-6726348-\$ or US-6762562-\$ or US-6860628-\$ or US-D290406-\$ or US-RE36696-\$ or US-5276591-\$ or US-5594433-\$ or US-6367179-\$ or US-6106126-\$ or US-6000807-\$ or US-5833350-\$ or US-5574423-\$.did. or (EP-1215735-\$.did.	US-PGPUB; USPAT; EPO	OR	OFF	2005/04/18 14:20
S57	36	S56 and switch\$4	US-PGPUB; USPAT; USOCR; EPO; JPO; DERWENT	OR	OFF	2005/04/18 14:23
S58	34	S56 and switch\$4 and batter\$4	US-PGPUB; USPAT; USOCR; EPO; JPO; DERWENT	OR	OFF	2005/04/18 14:25



S59	21	S56 and switch\$4 and batter\$4 and light adj emitting adj diode\$2	US-PGPUB; USPAT; USOCR; EPO; JPO; DERWENT	OR	OFF	2005/04/18 14:25
S60	12	362/800.ccls. and 362/260.ccls.	US-PGPUB; USPAT; USOCR; EPO; JPO; DERWENT	OR	OFF	2005/04/18 14:26
S62	215	(362/240.ccls. or 362/545.ccls.) and (light adj emitting adj diode\$2) and @ad<"20021211" and circuit adj board	US-PGPUB; USPAT; USOCR; EPO; JPO; DERWENT	OR	OFF	2005/04/18 14:28
S63	48	(US-20040100787-\$).did. or (US-4216410-\$ or US-4254453-\$ or US-4255746-\$ or US-4419658-\$ or US-4454452-\$ or US-4617561-\$ or US-4945280-\$ or US-4977351-\$ or US-5130909-\$ or US-5145247-\$ or US-5146209-\$ or US-5365145-\$ or US-5410453-\$ or US-5416384-\$ or US-5416679-\$ or US-5459955-\$ or US-5526236-\$ or US-5539623-\$ or US-5587705-\$ or US-5731759-\$ or US-5739639-\$ or US-5786767-\$ or US-5936532-\$ or US-6133839-\$ or US-6167648-\$ or US-6249221-\$).did. or (US-6367949-\$ or US-6384724-\$ or US-6420973-\$ or US-6570346-\$ or US-6609804-\$ or US-6624750-\$ or US-6682205-\$ or US-6726348-\$ or US-6762562-\$ or US-6860628-\$ or US-D290406-\$ or US-RE36696-\$ or US-5276591-\$ or US-5594433-\$ or US-6367179-\$ or US-6106126-\$ or US-6000807-\$ or US-5833350-\$ or US-5574423-\$ or US-4206493-\$).did. or (EP-1215735-\$).did.	US-PGPUB; USPAT; EPO	OR	OFF	2005/04/18 14:32
S64	11	S63 and switch\$4 and batter\$4 and light adj emitting adj diode\$2 and circuit adj board	US-PGPUB; USPAT; USOCR; EPO; JPO; DERWENT	OR	OFF	2005/04/18 14:35
S65	10	S63 and switch\$4 and batter\$4 and light adj emitting adj diode\$2 and circuit adj board and wall	US-PGPUB; USPAT; USOCR; EPO; JPO; DERWENT	OR	OFF	2005/04/18 14:36

S66	0	S63 and switch\$4 and batter\$4 and light adj emitting adj diode\$2 and circuit adj board and wall and alarm	US-PGPUB; USPAT; USOCR; EPO; JPO; DERWENT	OR	OFF	2005/04/18 14:36
S67	10	S63 and switch\$4 and batter\$4 and light adj emitting adj diode\$2 and circuit adj board and wall	US-PGPUB; USPAT; USOCR; EPO; JPO; DERWENT	OR	OFF	2005/04/18 16:18
S68	13	S63 and switch\$4 and (noise or sound or alarm or audible) and (test or indicator)	US-PGPUB; USPAT; USOCR; EPO; JPO; DERWENT	OR	OFF	2005/04/18 16:23
S69	3	S63 and switch\$4 and (noise or sound or alarm or audible) and (test or indicator) adj light	US-PGPUB; USPAT; USOCR; EPO; JPO; DERWENT	OR	OFF	2005/04/18 16:25
S71	3	S63 and switch\$4 and (noise or sound or alarm or audible) and (test or indicator) adj light and batter\$4	US-PGPUB; USPAT; USOCR; EPO; JPO; DERWENT	OR	OFF	2005/04/18 16:29
S72	1	S63 and switch\$4 and (test or indicator) adj light same batter\$4	US-PGPUB; USPAT; USOCR; EPO; JPO; DERWENT	OR	OFF	2005/04/18 16:29
S73	14	("1875956"   "3535506"   "4177500"   "4357648"   "4432043"   "4590543"   "4611264"   "4631649"   "4682078"   "4782432"   "4977489"   "5467258").PN.	US-PGPUB; USPAT; USOCR	OR	OFF	2005/04/18 17:12
S74	4	"362".clas. and wire with circuit adj board with battery with connector	US-PGPUB; USPAT; USOCR	OR	OFF	2005/04/18 17:22
S75	19	"362".clas. and adhesive adj (strip or tape) same protect\$4 adj (cover or film or layer)	US-PGPUB; USPAT; USOCR	OR	OFF	2005/04/18 17:23



UNITED STATES PATENT AND TRADEMARK OFFICE

*lh*

UNITED STATES DEPARTMENT OF COMMERCE  
United States Patent and Trademark Office  
Address: COMMISSIONER FOR PATENTS  
P.O. Box 1450  
Alexandria, Virginia 22313-1450  
www.uspto.gov

APPLICATION NO.	FILING DATE	FIRST NAMED INVENTOR	ATTORNEY DOCKET NO.	CONFIRMATION NO.
10/733,853	12/11/2003	Lyman O. Nielson	3358.2.1	9007

21552      7590      04/27/2005

MADSON & METCALF  
GATEWAY TOWER WEST  
SUITE 900  
15 WEST SOUTH TEMPLE  
SALT LAKE CITY, UT 84101

EXAMINER

HAN, JASON

ART UNIT      PAPER NUMBER

2875

DATE MAILED: 04/27/2005

Please find below and/or attached an Office communication concerning this application or proceeding.

<b>Office Action Summary</b>	Application No. 10/733,853	Applicant(s) NIELSON ET AL.	
	Examiner Jason M. Han	Art Unit 2875	

-- The MAILING DATE of this communication appears on the cover sheet with the correspondence address --

**Period for Reply**

A SHORTENED STATUTORY PERIOD FOR REPLY IS SET TO EXPIRE 3 MONTH(S) FROM THE MAILING DATE OF THIS COMMUNICATION.

- Extensions of time may be available under the provisions of 37 CFR 1.136(a). In no event, however, may a reply be timely filed after SIX (6) MONTHS from the mailing date of this communication.
- If the period for reply specified above is less than thirty (30) days, a reply within the statutory minimum of thirty (30) days will be considered timely.
- If NO period for reply is specified above, the maximum statutory period will apply and will expire SIX (6) MONTHS from the mailing date of this communication.
- Failure to reply within the set or extended period for reply will, by statute, cause the application to become ABANDONED (35 U.S.C. § 133). Any reply received by the Office later than three months after the mailing date of this communication, even if timely filed, may reduce any earned patent term adjustment. See 37 CFR 1.704(b).

**Status**

- 1)  Responsive to communication(s) filed on 11 December 2003.
- 2a)  This action is FINAL.                      2b)  This action is non-final.
- 3)  Since this application is in condition for allowance except for formal matters, prosecution as to the merits is closed in accordance with the practice under *Ex parte Quayle*, 1935 C.D. 11, 453 O.G. 213.

**Disposition of Claims**

- 4)  Claim(s) 1-32 is/are pending in the application.  
4a) Of the above claim(s) \_\_\_\_\_ is/are withdrawn from consideration.
- 5)  Claim(s) \_\_\_\_\_ is/are allowed.
- 6)  Claim(s) 1-32 is/are rejected.
- 7)  Claim(s) \_\_\_\_\_ is/are objected to.
- 8)  Claim(s) \_\_\_\_\_ are subject to restriction and/or election requirement.

**Application Papers**

- 9)  The specification is objected to by the Examiner.
- 10)  The drawing(s) filed on 11 December 2003 is/are: a)  accepted or b)  objected to by the Examiner.  
Applicant may not request that any objection to the drawing(s) be held in abeyance. See 37 CFR 1.85(a).  
Replacement drawing sheet(s) including the correction is required if the drawing(s) is objected to. See 37 CFR 1.121(d).
- 11)  The oath or declaration is objected to by the Examiner. Note the attached Office Action or form PTO-152.

**Priority under 35 U.S.C. § 119**

- 12)  Acknowledgment is made of a claim for foreign priority under 35 U.S.C. § 119(a)-(d) or (f).  
a)  All    b)  Some \*    c)  None of:
1.  Certified copies of the priority documents have been received.
2.  Certified copies of the priority documents have been received in Application No. \_\_\_\_\_.
3.  Copies of the certified copies of the priority documents have been received in this National Stage application from the International Bureau (PCT Rule 17.2(a)).

\* See the attached detailed Office action for a list of the certified copies not received.

**Attachment(s)**

- |  |   |
|--|---|
| 1) <input checked="" type="checkbox"/> Notice of References Cited (PTO-892)  | 4) <input type="checkbox"/> Interview Summary (PTO-413)<br>Paper No(s)/Mail Date. _____ |
| 2) <input type="checkbox"/> Notice of Draftsperson's Patent Drawing Review (PTO-948)   | 5) <input type="checkbox"/> Notice of Informal Patent Application (PTO-152)             |
| 3) <input checked="" type="checkbox"/> Information Disclosure Statement(s) (PTO-1449 or PTO/SB/08)<br>Paper No(s)/Mail Date <u>3/25/2004</u> . | 6) <input type="checkbox"/> Other: _____  |

## DETAILED ACTION

---

The following claims have been rejected in light of the specification, but rendered the broadest interpretation as construed by the examiner [MPEP 2111].

---

### *Claim Objections*

1. Claim 11 is objected to because of the following informalities: Claim dependency is incorrect and should be depended upon Claim 10. Appropriate correction is required.

### *Claim Rejections - 35 USC § 102*

The following is a quotation of the appropriate paragraphs of 35 U.S.C. 102 that form the basis for the rejections under this section made in this Office action:

A person shall be entitled to a patent unless –

(b) the invention was patented or described in a printed publication in this or a foreign country or in public use or on sale in this country, more than one year prior to the date of application for patent in the United States.

2. Claims 1-5 and 8-9 are rejected under 35 U.S.C. 102(b) as being anticipated by Ruskouski (U.S. Patent 5410453).
3. With regards to Claim 1, Ruskouski discloses a lighting apparatus including:
  - A ballast cover [Figure 10: (38A)];
  - A plurality of ballast cover holes [Figure 10: (40A)] in the ballast cover;
  - A circuit board [Figure 10: (42A)] having a plurality of light emitting diodes [Figure 10: (44A)], wherein the circuit board is positioned adjacent the ballast cover so that the plurality of light emitting diodes protrude through the plurality of ballast cover holes in the ballast cover [Figure 10].

Art Unit: 2875

4. With regards to Claim 2, Ruskouski discloses a battery [Figure 10: (62A)] for supplying power to the plurality of light emitting diodes.
5. With regards to Claim 3, Ruskouski discloses a switching circuit [Figure 10: (60A); Column 4, Lines 53-59] for controlling illumination of the plurality of light emitting diodes.
6. With regards to Claim 4, Ruskouski discloses the switching circuit including:
  - A first portion for placing the switching circuit in communication with a wall switch/electrical junction box [Column 4, Lines 42-47];
  - A second portion for coupling the switching portion to the battery [Column 4, Lines 48-50]; and
  - A third portion for coupling the switching circuit to the plurality of light emitting diodes [Column 4, Lines 42-47].
7. With regards to Claim 5, Ruskouski discloses the switching circuit coupling the battery to the plurality of light emitting diodes if the switching circuit is not receiving AC voltage from an AC voltage source that is coupled to the wall switch, and wherein the switching circuit does not couple the battery to the plurality of light emitting diodes if the switching circuit is receiving the AC voltage from the AC voltage source [Column 4, Lines 60-65].
8. With regards to Claim 8, Ruskouski discloses a battery charging circuit for charging the battery [Column 4, Lines 48-50].
9. With regards to Claim 9, Ruskouski discloses the battery charging circuit including a first portion for coupling the battery charging circuit to an AC voltage source,

Art Unit: 2875

and a second portion for coupling the battery charging circuit to the battery [Column 4, Lines 48-53].

10. Claims 12-16 and 19-20 are rejected under 35 U.S.C. 102(b) as being anticipated by Ruskouski (U.S. Patent 5410453).

11. With regards to Claim 12, Ruskouski discloses a lighting apparatus with a ballast cover including:

- A housing having an attachment surface [Figure 10: (72)] and an illumination surface [Figure 10: (66)];
- A plurality of illumination surface holes [Figure 10: (40A)] in the illumination surface;
- A circuit board [Figure 10: (42A)] having a plurality of light emitting diodes [Figure 10: (44A)], wherein the circuit board is positioned adjacent the housing so that the plurality of light emitting diodes protrude through the plurality of illumination surface holes in the illumination surface [Figure 10]; and
- A fastening mechanism [Figure 10: (70, 72)] for securing the attachment surface of the lighting apparatus to the ballast cover [Figure 10: (66, 68)].

12. With regards to Claim 13, Ruskouski discloses a battery [Figure 10: (62A)] for supplying power to the plurality of light emitting diodes.

13. With regards to Claim 14, Ruskouski discloses a switching circuit [Figure 10: (60A); Column 4, Lines 53-59] for controlling illumination of the plurality of light emitting diodes.

Art Unit: 2875

14. With regards to Claim 15, Ruskouski discloses the switching circuit including:

- A first portion for placing the switching circuit in communication with a wall switch/electrical junction box [Column 4, Lines 42-47];
- A second portion for coupling the switching portion to the battery [Column 4, Lines 48-50]; and
- A third portion for coupling the switching circuit to the plurality of light emitting diodes [Column 4, Lines 42-47].

15. With regards to Claim 16, Ruskouski discloses the switching circuit coupling the battery to the plurality of light emitting diodes if the switching circuit is not receiving AC voltage from an AC voltage source that is coupled to the wall switch, and wherein the switching circuit does not couple the battery to the plurality of light emitting diodes if the switching circuit is receiving the AC voltage from the AC voltage source [Column 4, Lines 60-65].

16. With regards to Claim 19, Ruskouski discloses a battery charging circuit for charging the battery [Column 4, Lines 48-50].

17. With regards to Claim 20, Ruskouski discloses the battery charging circuit including a first portion for coupling the battery charging circuit to an AC voltage source, and a second portion for coupling the battery charging circuit to the battery [Column 4, Lines 48-53].

***Claim Rejections - 35 USC § 103***

The following is a quotation of 35 U.S.C. 103(a) which forms the basis for all obviousness rejections set forth in this Office action:



Art Unit: 2875

(a) A patent may not be obtained though the invention is not identically disclosed or described as set forth in section 102 of this title, if the differences between the subject matter sought to be patented and the prior art are such that the subject matter as a whole would have been obvious at the time the invention was made to a person having ordinary skill in the art to which said subject matter pertains. Patentability shall not be negated by the manner in which the invention was made.

18. Claims 6-7 are rejected under 35 U.S.C. 103(a) as being unpatentable over Ruskouski (U.S. Patent 5410453) as applied to Claim 4 above, and further in view of Johnson et al. (U.S. Patent 4255746).

Ruskouski discloses the claimed invention as cited above, but does not specifically teach the switching circuit including a fourth portion for receiving an alarm signal from an alarm device (re: Claim 6), nor teaches the switching circuit coupling the battery to the plurality of light emitting diodes in response to receiving the alarm signal (re: Claim 7).

Johnson teaches, "Fire detector system 47 is connected across the terminals of battery 46. Upon detection of a fire condition, it provides a signal to alarm switch 48 which activates audible alarm 49. At the same time, a signal is provided to emergency light switch 45, causing auxiliary light 12 to be illuminated [Column 4, Lines 17-22]."

It would have been obvious to one ordinarily skilled in the art at the time the invention was made to modify the lighting apparatus of Ruskouski to incorporate the alarm device of Johnson so as to ensure greater safety to a user during emergency situations [e.g., fire].

19. Claims 10-11 are rejected under 35 U.S.C. 103(a) as being unpatentable over Ruskouski (U.S. Patent 5410453) as applied to Claim 2 above, and further in view of Blackman (U.S. Patent Re. 36696).

Art Unit: 2875

Ruskouski discloses the claimed invention as cited above, but does not specifically teach the circuit board including a battery test light coupled to the battery (re: Claim 10), nor teaches said battery test light protruding through one of the plurality of ballast cover holes (re: Claim 11).

Blackman teaches a circuit board [Figures 11-12: (310)] including a battery test light [Figures 11-12: (320)] coupled to the battery, and that protrudes through a hole [Figures 11-12: (308a, 308b)] in a cover.

It would have been obvious to one ordinarily skilled in the art at the time the invention was made to modify the lighting apparatus of Ruskouski to incorporate the battery test light of Blackman to help indicate to a user that the device is charging. Such indicator lights are commonly known in the art in warning a user of certain statuses of a device.

20. Claims 17-18 are rejected under 35 U.S.C. 103(a) as being unpatentable over Ruskouski (U.S. Patent 5410453) as applied to Claim 15 above, and further in view of Johnson et al. (U.S. Patent 4255746).

Ruskouski discloses the claimed invention as cited above, but does not specifically teach the switching circuit including a fourth portion for receiving an alarm signal from an alarm device (re: Claim 17), nor teaches the switching circuit coupling the battery to the plurality of light emitting diodes in response to receiving the alarm signal (re: Claim 18).

Johnson teaches, "Fire detector system 47 is connected across the terminals of battery 46. Upon detection of a fire condition, it provides a signal to alarm switch 48

Art Unit: 2875

which activates audible alarm 49. At the same time, a signal is provided to emergency light switch 45, causing auxiliary light 12 to be illuminated [Column 4, Lines 17-22].”

It would have been obvious to one ordinarily skilled in the art at the time the invention was made to modify the lighting apparatus of Ruskouski to incorporate the alarm device of Johnson so as to ensure greater safety to a user during emergency situations [e.g., fire].

21. Claims 21-22 are rejected under 35 U.S.C. 103(a) as being unpatentable over Ruskouski (U.S. Patent 5410453) as applied to Claim 13 above, and further in view of Blackman (U.S. Patent Re. 36696):

Ruskouski discloses the claimed invention as cited above, but does not specifically teach the circuit board including a battery test light coupled to the battery (re: Claim 10), nor teaches said battery test light protruding through one of the plurality of illumination surface holes (re: Claim 11).

Blackman teaches a circuit board [Figures 11-12: (310)] including a battery test light [Figures 11-12: (320)] coupled to the battery, and that protrudes through a hole [Figures 11-12: (308a, 308b)] in a cover.

It would have been obvious to one ordinarily skilled in the art at the time the invention was made to modify the lighting apparatus of Ruskouski to incorporate the battery test light of Blackman to help indicate to a user that the device is charging. Such indicator lights are commonly known in the art in warning a user of certain statuses of a device.

Art Unit: 2875

22. Claim 23 is rejected under 35 U.S.C. 103(a) as being unpatentable over Ruskouski (U.S. Patent 5410453) as applied to Claim 12 above, and further in view of Leveraus (U.S. Patent 4216524).

Ruskouski discloses the claimed invention as cited above, but does not specifically teach a connector in the attachment surface of the housing that snaps into a ballast cover hole in the ballast cover, wherein wires connect the circuit board to the battery through the connector. The examiner makes note that Ruskouski teaches both the circuit board and battery within the ballast cover, and that it would have been obvious to one ordinarily skilled in the art to separate the two components.

Leveraus teaches, "System battery 9 is connected to circuit board through external wire to terminal pin 20 of integral connector 110 [Column 5, Lines 27-29]."

It would have been obvious to one ordinarily skilled in the art at the time the invention was made to modify the lighting apparatus of Ruskouski to incorporate the remote connection of the battery and circuit board, as taught by Leveraus, in order to facilitate easier replacement/services to the separated components.

23. Claim 24 is rejected under 35 U.S.C. 103(a) as being unpatentable over Ruskouski (U.S. Patent 5410453) as applied to Claim 12 above, and further in view of Kim (U.S. Patent 4204272).

Ruskouski discloses the claimed invention as cited above, but does not specifically teach the fastening mechanism being an adhesive strip with a protective cover.

Kim teaches a fastening mechanism [Figure 2: (66)] being an adhesive strip with a protective cover [Figure 2: (68)].

It would have been obvious to one ordinarily skilled in the art at the time the invention was made to modify the lighting apparatus of Ruskouski to incorporate the adhesive strip with protective cover of Kim in order to provide strong, inexpensive attachment means between the attachment surface and the ballast cover.

24. Claims 25-27 are rejected under 35 U.S.C. 103(a) as being unpatentable over Ruskouski (U.S. Patent 5410453).

25. With regards to Claim 25, Ruskouski discloses an illuminating apparatus providing:

- A ballast cover [Figure 10: (66, 68)], wherein the cover has a plurality of ballast cover holes [Figure 10: (40A)] and is attachable to a light fixture [Figure 10: (48A)]; and
- A circuit board [Figure 10: (42A)] including a plurality of light emitting diodes [Figure 10: (44A)], whereby the circuit board is positioned adjacent the ballast cover so that the plurality of light emitting diodes protrude through the plurality of ballast cover holes in the ballast cover [Figure 10].

Though Ruskouski does not specifically teach the method for providing illumination, it has been held that a method claim would have been obvious to one ordinarily skilled in the art provided the prior art teaches all cited structural limitations.

Art Unit: 2875

26. With regards to Claim 26, Ruskouski discloses an apparatus illuminating a plurality of light emitting diodes when a light bulb within the light fixture is not illuminated [Column 1, Lines 17-43].

27. With regards to Claim 27, Ruskouski discloses an apparatus not illuminating a plurality of light emitting diodes when a light bulb within the light fixture is illuminated [Column 1, Lines 17-43].

28. Claim 28 is rejected under 35 U.S.C. 103(a) as being unpatentable over Ruskouski (U.S. Patent 5410453) as applied to Claim 25 above, and further in view of Johnson et al. (U.S. Patent 4255746).

Ruskouski discloses the claimed invention as cited above, but does not specifically teach providing reception of an alarm signal from an alarm device, and in response to receiving said signal, illuminating the plurality of light emitting diodes.

Johnson teaches, "Fire detector system 47 is connected across the terminals of battery 46. Upon detection of a fire condition, it provides a signal to alarm switch 48 which activates audible alarm 49. At the same time, a signal is provided to emergency light switch 45, causing auxiliary light 12 to be illuminated [Column 4, Lines 17-22]."

It would have been obvious to one ordinarily skilled in the art at the time the invention was made to modify the lighting apparatus of Ruskouski to incorporate the alarm device of Johnson so as to ensure greater safety to a user during emergency situations [e.g., fire].

29. Claims 29-31 are rejected under 35 U.S.C. 103(a) as being unpatentable over Ruskouski (U.S. Patent 5410453).

Art Unit: 2875

30. With regards to Claim 29, Ruskouski discloses an illuminating apparatus providing:

- A ballast cover [Figure 10: (66, 68)];
- A housing having an attachment surface [Figure 10: (72)] and an illumination surface [Figure 10: (66)], wherein the illumination surface has a plurality of illumination surface holes [Figure 10: (40A)]; and
- A circuit board [Figure 10: (42A)] including a plurality of light emitting diodes [Figure 10: (44A)], whereby the circuit board is positioned adjacent the housing so that the plurality of light emitting diodes protrude through the illumination surface holes in the illumination surface [Figure 10], and where the attachment surface of the housing is secured [Figure 10: (70, 72)] to the ballast cover.

Though Ruskouski does not specifically teach the method for providing illumination, it has been held that a method claim would have been obvious to one ordinarily skilled in the art provided the prior art teaches all cited structural limitations.

31. With regards to Claim 30, Ruskouski discloses an apparatus illuminating a plurality of light emitting diodes when a light bulb within the light fixture is not illuminated [Column 1, Lines 17-43].

32. With regards to Claim 31, Ruskouski discloses an apparatus not illuminating a plurality of light emitting diodes when a light bulb within the light fixture is illuminated [Column 1, Lines 17-43].

Art Unit: 2875

33. Claim 32 is rejected under 35 U.S.C. 103(a) as being unpatentable over Ruskouski (U.S. Patent 5410453) as applied to Claim 29 above, and further in view of Johnson et al. (U.S. Patent 4255746).

Ruskouski discloses the claimed invention as cited above, but does not specifically teach providing reception of an alarm signal from an alarm device, and in response to receiving said signal, illuminating the plurality of light emitting diodes.

Johnson teaches, "Fire detector system 47 is connected across the terminals of battery 46. Upon detection of a fire condition, it provides a signal to alarm switch 48 which activates audible alarm 49. At the same time, a signal is provided to emergency light switch 45, causing auxiliary light 12 to be illuminated [Column 4, Lines 17-22]."

It would have been obvious to one ordinarily skilled in the art at the time the invention was made to modify the lighting apparatus of Ruskouski to incorporate the alarm device of Johnson so as to ensure greater safety to a user during emergency situations [e.g., fire].

### ***Conclusion***

The prior art made of record and not relied upon is considered pertinent to applicant's disclosure.

The following references are cited to further show the state of art pertinent to the current application, but are not considered exhaustive:

US Patent 4206493 to Towne et al;

US Patent 5406724 to Lin;

US Patent 5574423 to Vosika et al;

US Patent 5833350 to Moreland;

US Patent 6726348 to Gloisten;

US Publication 2004/0100787 to Harris;



US Publication 2004/0100787 to Harris;

US Patent 6784357 to Wang.

Any inquiry concerning this communication or earlier communications from the examiner should be directed to Jason M. Han whose telephone number is (571) 272-2207. The examiner can normally be reached on 8:00am-5:00pm.

If attempts to reach the examiner by telephone are unsuccessful, the examiner's supervisor, Sandra O'Shea can be reached on (571) 272-2378. The fax phone number for the organization where this application or proceeding is assigned is 703-872-9306.

Information regarding the status of an application may be obtained from the Patent Application Information Retrieval (PAIR) system. Status information for published applications may be obtained from either Private PAIR or Public PAIR. Status information for unpublished applications is available through Private PAIR only. For more information about the PAIR system, see <http://pair-direct.uspto.gov>. Should you have questions on access to the Private PAIR system, contact the Electronic Business Center (EBC) at 866-217-9197 (toll-free).

JMH (4/18/2005)

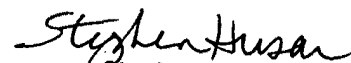
  
Stephen Husar  
Primary Examiner

***Information Disclosure Statement***

The information disclosure statement filed March 25, 2004 fails to comply with the provisions of 37 CFR 1.97, 1.98 and MPEP § 609 because the Non Patent Literature was not in appropriate format (please note the highlighted area). It has been placed in the application file, but the information referred to therein has not been considered as to the merits. Applicant is advised that the date of any re-submission of any item of information contained in this information disclosure statement or the submission of any missing element(s) will be the date of submission for purposes of determining compliance with the requirements based on the time of filing the statement, including all certification requirements for statements under 37 CFR 1.97(e). See MPEP § 609 ¶ C(1).



PTO/SB/08a (08-03)

Approved for use through 06/30/2006. OMB 0651-0031

U.S. Patent and Trademark Office: U.S. DEPARTMENT OF COMMERCE

Under the Paperwork Reduction Act of 1995, no persons are required to respond to a collection of information unless it contains a valid OMB control number.

Substitute for form 1449A/PTO		<b>Complete if Known</b>	
<b>INFORMATION DISCLOSURE STATEMENT BY APPLICANT</b>		Application Number	107733,853
		Filing Date	December 11, 2003
		First Named Inventor	Lyman O. Nielson
		Group Art Unit	
		Examiner Name	
		Attorney Docket Number	3358.2.1
		(use as many sheets as necessary)	
Sheet	1	Of	1

U.S. PATENT DOCUMENTS					
Examiner Initials *	Cite No. <sup>1</sup>	Document Number	Publication Date MM-DD-YYYY	Name of Patentee or Applicant of Cited Document	Pages, Columns, Lines, Where Relevant Passages or Relevant Figures Appear
		Number - Kind Code <sup>2</sup> (if known)			
JMH	U1	US-4,255,746	Mar. 10, 1981	Johnson et al.	/
JMH	U2	US-4,419,658	Dec. 6, 1983	Jarosz et al.	
JMH	U3	US-4,454,452	Jun. 12, 1984	Feldstein	
JMH	U4	US-4,617,561	Oct. 14, 1986	Brown	
JMH	U5	US-D290,406	Jun. 16, 1987	Brown	
JMH	U6	US-4,945,280	Jul. 31, 1990	Beghelli	
JMH	U7	US-4,977,351	Dec. 11, 1990	Bavaro et al.	
JMH	U8	US-5,130,909	Jul. 14, 1992	Gross	
JMH	U9	US-5,146,209	Sep. 8, 1992	Beghelli	
JMH	U10	US-5,145,247	Sep. 8, 1992	Mandy	
JMH	U11	US-5,365,145	Nov. 15, 1994	Fields	
JMH	U12	US-5,416,384	May 16, 1995	Bavaro	
JMH	U13	US-5,587,705	Dec. 24, 1996	Morris	
JMH	U14	US-5,731,759	Mar. 24, 1998	Finucan	
JMH	U15	US-5,739,639	Apr. 14, 1998	Johnson	
JMH	U16	US-5,786,767	Jul. 28, 1998	Severino	
JMH	U17	US-5,936,532	Aug. 10, 1999	Peralta	
JMH	U18	US-6,133,839	Oct. 17, 2000	Ellul, Jr. et al.	
JMH	U19	US-6,249,221	Jun. 19, 2001	Reed	
JMH	U20	US-6,384,724	May 7, 2002	Landais	
JMH	U21	US-6,420,973	Jul. 16, 2002	Acevedo	
JMH	U22	US-6,609,804	Aug. 26, 2003	Nolan et al.	
JMH	U23	US-6,624,750	Sep. 23, 2003	Marman et al.	

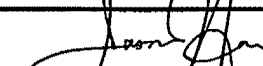
Examiner Signature		Date Considered	April 5, 2005
--------------------	---	-----------------	---------------

**EXAMINER:** Initial if reference considered, whether or not citation is in conformance with MPEP 609. Draw line through citation if not in conformance and not considered. Include copy of this form with next communication to applicant. <sup>1</sup> Applicant's unique citation designation number (optional). <sup>2</sup> See Kinds Codes of USPTO Patent Documents at [www.uspto.gov](http://www.uspto.gov) or MPEP 901.04. <sup>3</sup> Enter Office that issued the document, by the two-letter code (WIPO Standard ST.3). <sup>4</sup> For Japanese patent documents, the indication of the year of the reign of the Emperor must precede the serial number of the patent document. <sup>5</sup> Kind of document by the appropriate symbols as indicated on the document under WIPO Standard ST. 16 if possible. <sup>6</sup> Applicant is to place a check mark here if English language Translation is attached.

This collection of information is required by 37 CFR 1.97 and 1.98. The information is required to obtain or retain a benefit by the public which is to file (and by the USPTO to process) an application. Confidentiality is governed by 35 U.S.C. 122 and 37 CFR 1.14. This collection is estimated to take 2 hours to complete, including gathering, preparing, and submitting the completed application form to the USPTO. Time will vary depending upon the individual case. Any comments on the amount of time you are required to complete this form and/or suggestions for reducing this burden, should be sent to the Chief Information Officer, U.S. Patent and Trademark Office, U.S. Department of Commerce, P.O. Box 1450, Alexandria, VA 22313-1450. DO NOT SEND FEES OR COMPLETED FORMS TO THIS ADDRESS. SEND TO: Commissioner for Patents, P.O. Box 1450, Alexandria, VA 22313-1450.

If you need assistance in completing this form, call 1-800-PTO-9199 and selection option 2.



PTO/SB/08b (08-03)

Approved for use through 08/30/2006. OMB 0851-0031

U.S. Patent and Trademark Office: U.S. DEPARTMENT OF COMMERCE

Under the Paperwork Reduction Act of 1995, no persons are required to respond to a collection of information unless it contains a valid OMB control number.

Substitute for form 1449B/PTO		<b>Complete if Known</b>	
<b>INFORMATION DISCLOSURE STATEMENT BY APPLICANT</b>  <i>(use as many sheets as necessary)</i>		Application Number	10/733,853
		Filing Date	December 11, 2003
		First Named Inventor	Lyman O. Nielson
		Group Art Unit	
		Examiner Name	
		Attorney Docket Number	3358.2.1
Sheet	1	Of	1

NON PATENT LITERATURE DOCUMENTS			
Examiner Initials *	Cite No. <sup>1</sup>	Include name of the author (in CAPITAL LETTERS), title of the article (when appropriate), title of the item (book, magazine, journal, serial, symposium, catalog, etc.), date, page(s), volume-issue number(s), publisher, city and/or country where published.	T <sup>2</sup>
	O1	ARPAD A. BERGH, "A View on The Future of Solid State Lighting"	
	O2	"Egress Aisles - Exit Signs - Egress Lighting Requirements"	
	O3	"Down Light / Night Light Strip"	
	O4	"Super Energy Efficient Solid-State Egress/Night Lighting"	
	O5	"GTD Generator Transfer Device For Generator-Supplied Lighting"	
	O6	"LED Light Strip Illuminator Module"	
	O7	STEVE JOHNSON, "The Solid State Lighting Initiative: An Industry/DOE Collaborative Effort," Architectural Lighting, Nov./Dec. 2000, pp. 1-5	
	O8	"Surviv Lite Emergency Egress Lighting"	
	O9	MARK KENDALL and MICHAEL SCHOLAND, "Energy Savings Potential of Solid State Lighting in General Lighting Applications," April 2001	
	O10	"The LED Advantage"	
	O11	"Homeowners Insurance - Rising Cost of Homeowners Insurance"	
	O12	"School, college, and university dormitory, fraternity, and sorority house fires"	
	O13	"Light Emitting Diodes for Lighting Applications"	
	O14	"Super Energy Efficient Solid-State Egress/Night Lighting"	
	O15	"Kidde Ionization Smoke Alarm w/ Exit Light"	
	O16	"3 in 1 LED Emergency Light"	
	O17	"PowerFailure Night Light," User's Manual	
	O18	"Gas and Smoke Detector - ESM-768 Semiconductor / Ionisation Technology"	
	O19	"SA358: Smoke Alarm with Emergency Light"	
	O20	"Sage Lighting Ltd. LED Lighting Products"	

Examiner Signature		Date Considered	April 5, 2005
--------------------	--	-----------------	---------------

\*EXAMINER: Initial if reference considered, whether or not citation is in conformance with MPEP 609. Draw line through citation if not in conformance and not considered. Include copy of this form with next communication to applicant.

<sup>1</sup> Applicant's unique citation designation number (optional). <sup>2</sup> Applicant is to place a check mark here if English language Translation is attached.

This collection of information is required by 37 CFR 1.97 and 1.98. The information is required to obtain or retain a benefit by the public which is to file (and by the USPTO to process) an application. Confidentiality is governed by 35 U.S.C. 122 and 37 CFR 1.14. This collection is estimated to take 2 hours to complete, including gathering, preparing, and submitting the completed application form to the USPTO. Time will vary depending upon the individual case. Any comments on the amount of time you are required to complete this form and/or suggestions for reducing this burden, should be sent to the Chief Information Officer, U.S. Patent and Trademark Office, U.S. Department of Commerce, P.O. Box 1450, Alexandria, VA 22313-1450. DO NOT SEND FEES OR COMPLETED FORMS TO THIS ADDRESS. SEND TO: Commissioner for Patents, P.O. Box 1450, Alexandria, VA 22313-1450.

If you need assistance in completing this form, call 1-800-PTO-9199 and selection option 2.

<b>Notice of References Cited</b>	Application/Control No. 10/733,853	Applicant(s)/Patent Under Reexamination NIELSON ET AL.	
	Examiner Jason M. Han	Art Unit 2875	Page 1 of 1

**U.S. PATENT DOCUMENTS**

*	Document Number Country Code-Number-Kind Code	Date MM-YYYY	Name	Classification
A	US-5,410,453	04-1995	Ruskouski, Charles R.	362/20
B	US-RE36,696	05-2000	Blackman, Stephen E.	362/20
C	US-4,216,524	08-1980	Leveraus, James E.	362/464
D	US-4,204,272	05-1980	Kim, Sunyong P.	362/200
E	US-4,206,493	06-1980	Towne et al.	362/240
F	US-5,406,724	04-1995	Lin, Wen-Tsung	36/137
G	US-5,574,423	11-1996	Vosika et al.	340/333
H	US-5,833,350	11-1998	Moreland, Gregory B.	362/95
I	US-6,726,348	04-2004	Gloisten, Jennifer L.	362/372
J	US-2004/0100787	05-2004	Harris, William F.	362/020
K	US-6,784,357	08-2004	Wang, Chao Hsiang	136/244
L	US-			
M	US-			

**FOREIGN PATENT DOCUMENTS**

*	Document Number Country Code-Number-Kind Code	Date MM-YYYY	Country	Name	Classification
N					
O					
P					
Q					
R					
S					
T					

**NON-PATENT DOCUMENTS**

*	Include as applicable: Author, Title, Date, Publisher, Edition or Volume, Pertinent Pages)
U	
V	
W	
X	

\*A copy of this reference is not being furnished with this Office action. (See MPEP § 707.05(a).)  
 Dates in MM-YYYY format are publication dates. Classifications may be US or foreign.



UNITED STATES PATENT AND TRADEMARK OFFICE

UNITED STATES DEPARTMENT OF COMMERCE  
 United States Patent and Trademark Office  
 Address: COMMISSIONER FOR PATENTS  
 P.O. Box 1450  
 Alexandria, Virginia 22313-1450  
 www.uspto.gov



Bib Data Sheet

CONFIRMATION NO. 9007

SERIAL NUMBER 10/733,853	FILING DATE 12/11/2003  RULE	CLASS 362	GROUP ART UNIT 2875	ATTORNEY DOCKET NO. 3358.2.1
-----------------------------	---------------------------------------	--------------	------------------------	------------------------------------

APPLICANTS

Lyman O. Nielson, Fruit Heights, UT;  
 Norman B. Hess, Fruit Heights, UT; JMH

\*\* CONTINUING DATA \*\*\*\*\*  
 This appln claims benefit of 60/432,562 12/11/2002 JMH

\*\* FOREIGN APPLICATIONS \*\*\*\*\*

IF REQUIRED, FOREIGN FILING LICENSE GRANTED \*\* SMALL ENTITY \*\*  
 \*\* 05/18/2004

Foreign Priority claimed <input type="checkbox"/> yes <input checked="" type="checkbox"/> no	STATE OR	SHEETS	TOTAL	INDEPENDENT
35 USC 119 (a-d) conditions met <input type="checkbox"/> yes <input checked="" type="checkbox"/> no <input type="checkbox"/> Met after Allowance	COUNTRY	DRAWING	CLAIMS	CLAIMS
Verified and Acknowledged <i>Lyman O. Nielson</i> Examiner's Signature	UT	5	32	4
<i>JMH</i> Initials				

ADDRESS  
 21552  
 MADSON & METCALF  
 GATEWAY TOWER WEST  
 SUITE 900  
 15 WEST SOUTH TEMPLE  
 SALT LAKE CITY , UT  
 84101

TITLE  
 Low-voltage lighting apparatus for satisfying after-hours lighting requirements, emergency lighting requirements, and low light requirements

FILING FEE	FEES: Authority has been given in Paper	<input type="checkbox"/> All Fees <input type="checkbox"/> 1.16 Fees ( Filing ) <input type="checkbox"/> 1.17 Fees ( Processing Ext. of
------------	---	---

**Index of Claims**

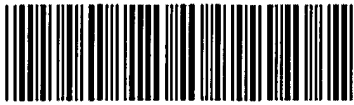

Application/Control No.

10/733,853

Examiner

Jason M. Han

Applicant(s)/Patent under Reexamination

NIELSON ET AL.

Art Unit

2875

√	Rejected
=	Allowed

-	(Through numeral) Cancelled
+	Restricted

N	Non-Elected
I	Interference

A	Appeal
O	Objected

Claim		Date									
Final	Original	4/18/05									
	1	√									
	2	√									
	3	√									
	4	√									
	5	√									
	6	√									
	7	√									
	8	√									
	9	√									
	10	√									
	11	√									
	12	√									
	13	√									
	14	√									
	15	√									
	16	√									
	17	√									
	18	√									
	19	√									
	20	√									
	21	√									
	22	√									
	23	√									
	24	√									
	25	√									
	26	√									
	27	√									
	28	√									
	29	√									
	30	√									
	31	√									
	32	√									
	33										
	34										
	35										
	36										
	37										
	38										
	39										
	40										
	41										
	42										
	43										
	44										
	45										
	46										
	47										
	48										
	49										
	50										

Claim		Date									
Final	Original										
	51										
	52										
	53										
	54										
	55										
	56										
	57										
	58										
	59										
	60										
	61										
	62										
	63										
	64										
	65										
	66										
	67										
	68										
	69										
	70										
	71										
	72										
	73										
	74										
	75										
	76										
	77										
	78										
	79										
	80										
	81										
	82										
	83										
	84										
	85										
	86										
	87										
	88										
	89										
	90										
	91										
	92										
	93										
	94										
	95										
	96										
	97										
	98										
	99										
	100										

Claim		Date									
Final	Original										
	101										
	102										
	103										
	104										
	105										
	106										
	107										
	108										
	109										
	110										
	111										
	112										
	113										
	114										
	115										
	116										
	117										
	118										
	119										
	120										
	121										
	122										
	123										
	124										
	125										
	126										
	127										
	128										
	129										
	130										
	131										
	132										
	133										
	134										
	135										
	136										
	137										
	138										
	139										
	140										
	141										
	142										
	143										
	144										
	145										
	146										
	147										
	148										
	149										
	150										

**Search Notes**

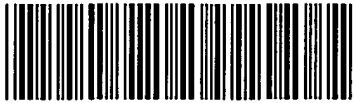

Application/Control No.

10/733,853

Examiner

Jason M. Han

Applicant(s)/Patent under Reexamination

NIELSON ET AL.

Art Unit

2875

**SEARCHED**

Class	Subclass	Date	Examiner
362	20	4/18/2005	JMH
362	228	4/18/2005	JMH
362	240	4/18/2005	JMH
362	260	4/18/2005	JMH
362	545	4/18/2005	JMH
362	555	4/18/2005	JMH
362	800	4/18/2005	JMH

**INTERFERENCE SEARCHED**

Class	Subclass	Date	Examiner

**SEARCH NOTES  
(INCLUDING SEARCH STRATEGY)**

	DATE	EXMR
Search History	4/18/2005	JMH
P.E. Stephen Husar	4/18/2005	JMH
STIC Search provided by Michael Obinna	4/13/2005	JMH



IFW ✓

CERTIFICATE OF MAILING

I hereby certify that this correspondence is being deposited with the United States Postal Service as first class mail in an envelope addressed to: Mail Stop Amendment, Commissioner for Patents, P.O. Box 1450, Alexandria, VA 22313-1450, on October 6, 2005.

*Lyman O. Nielson*  
Attorney for Applicants

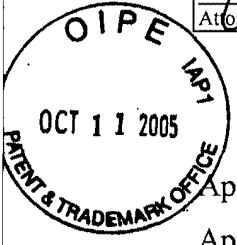

IN THE UNITED STATES PATENT AND TRADEMARK OFFICE

Appl. No.: 10/733,853  
 Applicant: Lyman O. Nielson, *et al.*  
 Title: LOW-VOLTAGE LIGHTING APPARATUS FOR SATISFYING AFTER-HOURS LIGHTING REQUIREMENTS, EMERGENCY LIGHTING REQUIREMENTS, AND LOW LIGHT REQUIREMENTS  
 Filed: December 11, 2003  
 TC/A.U.: 2875  
 Examiner: Jason Han  
 Docket No.: 3358.2.1  
 Customer No.: 21552

Mail Stop Amendment  
Commissioner for Patents  
P.O. Box 1450  
Alexandria, VA 22313-1450

**AMENDMENT AND RESPONSE TO OFFICE ACTION**

Dear Sir:

In response to the Office action mailed April 27, 2005, please amend the above-identified application as follows:

**Amendments to the Claims** are reflected in the listing of claims which begins on page 2 of this paper.

**Remarks/Arguments** begin on page 8 of this paper.

The appropriate "Petition for an Extension of Time" under 37 CFR 1.136(a) to extend the deadline for responding to this Office Action (including the corresponding fee) accompanies this paper.

This listing of claims will replace all prior versions, and listings, of claims in the application:

**Listing of Claims:**

Claim 1 (Currently Amended): An energy-efficient lighting apparatus, comprising:  
a ballast cover;

a plurality of ballast cover holes in the ballast cover;

a circuit board comprising a plurality of light-emitting diodes, wherein the circuit board is positioned adjacent the ballast cover so that the plurality of light-emitting diodes protrude through the plurality of ballast cover holes in the ballast cover, wherein the lighting apparatus is coupled to a wall switch and wherein the illumination of the light-emitting diodes is controllable based upon the position of the wall switch.

Claim 2 (Original): The lighting apparatus of claim 1, further comprising a battery for supplying power to the plurality of light-emitting diodes.

Claim 3 (Original): The lighting apparatus of claim 2, further comprising a switching circuit for controlling illumination of the plurality of light-emitting diodes.

Claim 4 (Original): The lighting apparatus of claim 3, wherein the switching circuit comprises:

a first portion for placing the switching circuit in communication with a wall switch;

a second portion for coupling the switching circuit to the battery; and

a third portion for coupling the switching circuit to the plurality of light-emitting diodes.

Claim 5 (Original): The lighting apparatus of claim 4, wherein the switching circuit couples the battery to the plurality of light-emitting diodes if the switching circuit is not receiving

AC voltage from an AC voltage source that is coupled to the wall switch, and wherein the switching circuit does not couple the battery to the plurality of light-emitting diodes if the switching circuit is receiving the AC voltage from the AC voltage source.

Claim 6 (Original): The lighting apparatus of claim 4, wherein the switching circuit further comprises a fourth portion for receiving an alarm signal from an alarm device.

Claim 7 (Original): The lighting apparatus of claim 6, wherein the switching circuit couples the battery to the plurality of light-emitting diodes if the switching circuit is receiving the alarm signal.

Claim 8 (Original): The lighting apparatus of claim 2, further comprising a battery charging circuit for charging the battery.

Claim 9 (Original): The lighting apparatus of claim 8, wherein the battery charging circuit comprises:

a first portion for coupling the battery charging circuit to an AC voltage source; and  
a second portion for coupling the battery charging circuit to the battery.

Claim 10 (Original): The lighting apparatus of claim 2, wherein the circuit board further comprises a battery test light coupled to the battery.

Claim 11 (Currently Amended): The lighting apparatus of claim 10 ~~13~~, wherein the battery test light protrudes through one of the plurality of ballast cover holes.

Claim 12 (Currently Amended): An energy-efficient lighting apparatus for retrofit with

an existing light fixture having a ballast cover, comprising:

- a housing having an attachment surface and an illumination surface;
- a plurality of illumination surface holes in the illumination surface;
- a circuit board comprising a plurality of light-emitting diodes, wherein the circuit board is positioned adjacent the housing so that the plurality of light-emitting diodes protrude through the plurality of illumination surface holes in the illumination surface; and
- a fastening mechanism for securing the attachment surface of the lighting apparatus to the ballast cover, wherein the lighting apparatus is coupled to a wall switch and wherein the illumination of the light-emitting diodes is controllable based upon the position of the wall switch.

Claim 13 (Original): The lighting apparatus of claim 12, further comprising a battery for supplying power to the plurality of light-emitting diodes.

Claim 14 (Original): The lighting apparatus of claim 13, further comprising a switching circuit for controlling illumination of the plurality of light-emitting diodes.

Claim 15 (Original): The lighting apparatus of claim 14, wherein the switching circuit comprises:

- a first portion for placing the switching circuit in communication with a wall switch;
- a second portion for coupling the switching circuit to the battery; and
- a third portion for coupling the switching circuit to the plurality of light-emitting diodes.

Claim 16 (Original): The lighting apparatus of claim 15, wherein the switching circuit couples the battery to the plurality of light-emitting diodes if the switching circuit is not receiving

AC voltage from an AC voltage source that is coupled to the wall switch, and wherein the switching circuit does not couple the battery to the plurality of light-emitting diodes if the switching circuit is receiving the AC voltage from the AC voltage source.

Claim 17 (Original): The lighting apparatus of claim 15, wherein the switching circuit further comprises a fourth portion for receiving an alarm signal from an alarm device.

Claim 18 (Original): The lighting apparatus of claim 17, wherein the switching circuit couples the battery to the plurality of light-emitting diodes if the switching circuit is receiving the alarm signal.

Claim 19 (Original): The lighting apparatus of claim 13, further comprising a battery charging circuit for charging the battery.

Claim 20 (Original): The lighting apparatus of claim 19, wherein the battery charging circuit comprises:

a first portion for coupling the battery charging circuit to the AC voltage source; and  
a second portion for coupling the battery charging circuit to the battery.

Claim 21 (Original): The lighting apparatus of claim 13, wherein the circuit board further comprises a battery test light coupled to the battery.

Claim 22 (Original): The lighting apparatus of claim 21, wherein the battery test light protrudes through one of the plurality of illumination surface holes.

Claim 23 (Original): The lighting apparatus of claim 12, further comprising:

a connector in the attachment surface of the housing that snaps into a ballast cover hole in the ballast cover; and  
wires connecting the circuit board to the battery through the connector.

Claim 24 (Original): The lighting apparatus of claim 12, wherein the fastening mechanism comprises an adhesive strip having a protective cover.

Claim 25 (Currently Amended): A method for providing illumination to an area in an energy-efficient manner, comprising:

providing a ballast cover, the ballast cover having a plurality of ballast cover holes, the ballast cover being attachable to a light fixture;  
providing a circuit board comprising a plurality of light-emitting diodes; and  
positioning the circuit board adjacent the ballast cover so that the plurality of light-emitting diodes protrude through the plurality of ballast cover holes in the ballast cover, wherein the light fixture is coupled to a wall switch and wherein the illumination of the light-emitting diodes is controllable based upon the position of the wall switch.

Claim 26 (Original): The method of claim 25, further comprising illuminating the plurality of light-emitting diodes when a light bulb within the light fixture is not illuminated.

Claim 27 (Original): The method of claim 25, further comprising not illuminating the plurality of light-emitting diodes when a light bulb within the light fixture is illuminated.

Claim 28 (Original): The method of claim 25, further comprising:  
receiving an alarm signal from an alarm device; and

in response to receiving the alarm signal, illuminating the plurality of light-emitting diodes.

Claim 29 (Currently Amended): A method for retrofitting a light fixture with an energy-efficient lighting apparatus, the light fixture having a ballast cover, the method comprising: providing a housing having an attachment surface and an illumination surface, wherein the illumination surface comprises a plurality of illumination surface holes; providing a circuit board comprising a plurality of light-emitting diodes; positioning the circuit board adjacent the housing so that the plurality of light-emitting diodes protrude through the plurality of illumination surface holes in the illumination surface; and securing the attachment surface of the housing to the ballast cover, wherein the lighting apparatus is coupled to a wall switch and wherein the illumination of the light-emitting diodes is controllable based upon the position of the wall switch.

Claim 30 (original): The method of claim 29, further comprising illuminating the plurality of light-emitting diodes when a light bulb within the light fixture is not illuminated.

Claim 31 (Original): The method of claim 29, further comprising not illuminating the plurality of light-emitting diodes when a light bulb within the light fixture is illuminated.

Claim 32 (Original): The method of claim 29, further comprising: receiving an alarm signal from an alarm device; and in response to receiving the alarm signal, illuminating the plurality of light-emitting diodes.

### **REMARKS/ARGUMENTS**

Claims 1-32 are pending in the present application. In the Office Action mailed April 27, 2005, the Examiner rejected claims 1-32 under either 35 U.S.C. § 102(b) or 35 U.S.C. § 103(a). Claim 11 was also objected to as containing an informality.

As a result of this paper, claims 1, 11, 12, 25, and 29 have been amended. In light of these changes and the following remarks, reconsideration and allowance of the present claims is respectfully requested.

#### **I. Objection to Claim 11**

In the Office Action, the Examiner objected to claim 11 as containing an informality. More particularly, the Examiner objected to claim 11 as having incorrect claim dependency. The amendment to claim 11 in the present paper corrects this issue. Accordingly, withdrawal of this claim objection is respectfully requested.

#### **II. Rejection of Claims 1-5, 8-9, 12-16, and 19-20 Under 35 U.S.C. § 102(b)**

In the Office Action, the Examiner rejected claims 1-5, 8-9, 12-16, and 19-20 under 35 U.S.C. § 102(b) as being anticipated by U.S. Patent No. 5,410,453 issued to Ruskouski (hereinafter "Ruskouski"). These rejections are respectfully traversed.

As explained by the MPEP, "[a] claim is anticipated only if each and every element as set forth in the claim is found, either expressly or inherently described, in a single prior art reference." M.P.E.P. § 2131 (citing *Verdegal Bros. v. Union Oil Co. of California*, 2 USPQ2d 1051, 1053 (Fed. Cir. 1987)). "The identical invention must be shown in as complete detail as is contained in the ... claim." *Id.* (citing *Richardson v. Suzuki Motor Co.*, 9 USPQ2d 1913, 1920 (Fed. Cir. 1989)). In addition, "the reference must be enabling and describe the applicant's claimed invention sufficiently to have placed it in possession of a person of ordinary skill in the field of the invention." *In re Paulsen*, 31 USPQ2d 1671, 1673 (Fed. Cir. 1994).



Independent claims 1 and 12 have been amended to recite that the “the lighting apparatus is coupled to a wall switch and wherein the illumination of the light-emitting diodes is controllable based upon the position of the wall switch.” Support for this limitation is found in paragraphs 39-47, and more particularly in paragraphs 44-45, of Applicants’ specification.

Applicants submit that this limitation is not disclosed by Ruskouski. Specifically, Ruskouski teaches a lighting system that is used to illuminate an “EXIT” sign. “EXIT” signs are constantly-illuminated signs that are commonly found in theaters, office buildings, restaurants, commercial buildings, etc. as a means of indicating to building occupants how they may safely exit the building in the event of an emergency, in the event that the building loses power, etc. *See* Ruskouski, Col. 1, lines 8-16. To the extent that the illuminated “EXIT” signs taught by Ruskouski may be interpreted as comprising the “lighting apparatus” of claim 1 and 12, Ruskouski does not teach that that the illumination of light-emitting diodes within Ruskouski’s “EXIT” signs “is controllable based upon the position of the wall switch.” Rather, Ruskouski (like other types of “EXIT” signs known in the art) teaches a system in which the “EXIT” signs will be constantly illuminated and will not be controlled by a user turning a wall switch on or off.

Thus, because Ruskouski fails to disclose the above-recited claim elements outlined by independent claims 1 and 12, this reference does not operate to anticipate these claims under 35 U.S.C. § 102(b). Withdrawal of this rejection is respectfully requested.

With respect to dependent claims 2-5 and 8-9, these claims depend either directly or indirectly from independent claim 1. Likewise, claims 13-16 and 19-20 depend either directly or indirectly from independent claim 12. Accordingly, Applicants respectfully request that the rejection of dependent claims 2-5, 8-9, 13-16 and 19-20 be withdrawn for at least the same reasons as those presented above in connection with claims 1 and 12.

**III. Rejection of Claims 6-7, 17-18, 28, and 32 Under 35 U.S.C. § 103(a)**

In the Office Action, the Examiner rejected claims 6-7, 17-18, 28, and 32 under 35 U.S.C. § 103(a) as being unpatentable over Ruskouski in view of U.S. Patent No. 4,255,746 issued to Johnson *et al.* (hereinafter "Johnson"). This rejection is respectfully traversed.

The M.P.E.P. states that

To establish a *prima facie* case of obviousness, three basic criteria must be met. First, there must be some suggestion or motivation, either in the references themselves or in the knowledge generally available to one of ordinary skill in the art, to modify the reference or to combine reference teachings. Second, there must be a reasonable expectation of success. Finally, the prior art reference (or references when combined) must teach or suggest all the claim limitations. The teaching or suggestion to make the claimed combination and the reasonable expectation of success must both be found in the prior art, and not based on applicant's disclosure.

The initial burden is on the examiner to provide some suggestion of the desirability of doing what the inventor has done. To support the conclusion that the claimed invention is directed to obvious subject matter, either the references must expressly or impliedly suggest the claimed invention or the examiner must present a convincing line of reasoning as to why the artisan would have found the claimed invention to have been obvious in light of the teachings of the references.

M.P.E.P. § 2142.

Applicants respectfully submit that the claims at issue are patentably distinct from the cited references in that these claims contain limitations that are not taught or suggested by the prior art.

With respect to claims 6, 7, 17, 18, and 32, these dependent claims all include the limitation that the "lighting apparatus is coupled to a wall switch and wherein the illumination of the light-emitting diodes is controllable based upon the position of the wall switch." As explained above in greater detail, this limitation is not taught or suggested by Ruskouski. Likewise, Applicants can find no teaching or disclosure in Johnson (nor has the Examiner cited

to any such teaching) that would make up for the deficiencies of Ruskouski. Accordingly, because all of the limitations found in claims 6, 7, 17, 18, and 32 are not taught by either Ruskouski and Johnson, and as such, this combination of references does not operate to render claims 6, 7, 17, 18, and 32 *prima facie* obvious under 35 U.S.C. § 103(a). Withdrawal of this rejection is respectfully requested.

Further, dependent claim 28 depends from claim 25 and thus recites the limitation that “the light fixture is coupled to a wall switch and wherein the illumination of the light-emitting diodes is controllable based upon the position of the wall switch.” As with the limitations previously discussed, this limitation is likewise not taught or suggested by Ruskouski or Johnson. Accordingly, because Ruskouski and Johnson fail to teach or suggest this limitation, this claim may not be rejected as being obvious in light of these references. Withdrawal of this rejection is respectfully requested.

#### **IV. Rejection of Claims 10-11 and 21-22 Under 35 U.S.C. § 103(a)**

In the Office Action, the Examiner rejected claims 10-11 and 21-22 under 35 U.S.C. § 103(a) as being unpatentable over Ruskouski in view of U.S. Patent Reissue No. 36,696 issued to Blackman (hereinafter “Blackman”). This rejection is respectfully traversed.

As explained above, a claim cannot properly be rejected under 35 U.S.C. § 103(a) unless all of the claim limitations are taught or suggested by the cited references. *See e.g.*, M.P.E.P. § 2143.03. Applicants respectfully submit that all of the limitations of claims 10, 11, 21, 22 are not found in the prior art references. Specifically, dependent claims 10, 11, 21, and 22 all include the limitation that the “the lighting apparatus is coupled to a wall switch and wherein the illumination of the light-emitting diodes is controllable based upon the position of the wall switch.” As explained above in greater detail, this limitation is not taught or suggested by Ruskouski. Likewise, Applicants can find no teaching or disclosure in Blackman (nor has the Examiner cited to any such teaching) that would make up for the deficiencies of Ruskouski.

Accordingly, Applicants submit that all of the limitations found in claims 10, 11, 21, and 22 are not taught by Ruskouski and Blackman, and as such, this combination of references does not render these claims *prima facie* obvious under 35 U.S.C. § 103(a). Withdrawal of this rejection is respectfully requested.

**V. Rejection of Claim 23 Under 35 U.S.C. § 103(a)**

In the Office Action, the Examiner rejected claim 23 under 35 U.S.C. § 103(a) as being unpatentable over Ruskouski in view of U.S. Patent No. 4,216,524 issued to Leveraus (hereinafter “Leveraus”). This rejection is respectfully traversed.

As explained above, a claim cannot properly be rejected under 35 U.S.C. § 103(a) unless all of the claim limitations are taught or suggested by the cited references. *See* M.P.E.P. § 2143.03. Applicants respectfully submit that all of the limitations of claim 23 are not found in the prior art references. Specifically, claim 23 depends from claim 12 and thus includes the limitation that the “lighting apparatus is coupled to a wall switch and wherein the illumination of the light-emitting diodes is controllable based upon the position of the wall switch.” As explained above in greater detail, this limitation is not taught or suggested by Ruskouski. Likewise, Applicants can find no teaching or disclosure in Leveraus (nor has the Examiner cited to any such teaching) that would make up for the deficiencies of Ruskouski. Accordingly, because the combined teachings of Ruskouski and Leveraus do not teach or suggest all of the limitations found in claim 23, this claim cannot properly be rejected under 35 U.S.C. § 103(a). Withdrawal of this rejection is respectfully requested.

**VI. Rejection of Claim 24 Under 35 U.S.C. § 103(a)**

In the Office Action, the Examiner rejected claim 24 under 35 U.S.C. § 103(a) as being unpatentable over Ruskouski in view of U.S. Patent No. 4,204,272 issued to Kim (hereinafter “Kim”). This rejection is respectfully traversed.

As explained above, a claim cannot properly be rejected under 35 U.S.C. § 103(a) unless all of the claim limitations are taught or suggested by the cited references. *See* M.P.E.P. § 2143.03. Applicants respectfully submit that all of the limitations of claim 24 are not found in the prior art references. Specifically, claim 24 depends from claim 12 and thus includes the limitation that the “lighting apparatus is coupled to a wall switch and wherein the illumination of the light-emitting diodes is controllable based upon the position of the wall switch.” As explained above in greater detail, this limitation is not taught or suggested by Ruskouski. Likewise, Applicants can find no teaching or disclosure in Kim (nor has the Examiner cited to any such teaching) that would make up for the deficiencies of Ruskouski. Accordingly, because the combined teachings of Ruskouski and Kim do not teach or suggest all of the limitations found in claim 24, this claim cannot properly be rejected under 35 U.S.C. § 103(a). Withdrawal of this rejection is respectfully requested.

**VII. Rejection of Claims 25-27 and 29-31 Under 35 U.S.C. § 103(a)**

In the Office Action, the Examiner rejected claims 25-27 under 35 U.S.C. § 103(a) as being unpatentable over Ruskouski. This rejection is respectfully traversed.

As explained above, a claim cannot properly be rejected under 35 U.S.C. § 103(a) unless all of the claim limitations are taught or suggested by the cited references. *See* M.P.E.P. § 2143.03. With respect to claims 29-31, these claims all recite the limitation that the “lighting apparatus is coupled to a wall switch and wherein the illumination of the light-emitting diodes is controllable based upon the position of the wall switch.” As explained above, this limitation is not taught or suggested by Ruskouski, and thus, Ruskouski may not be used to reject these claims under 35 U.S.C. § 103(a). Withdrawal of this rejection is respectfully requested.

Claims 25-27 also have limitations that are not taught or suggested by Ruskouski. Specifically, claims 25-27 recite the limitation that the “light fixture is coupled to a wall switch” and that the “illumination of the light-emitting diodes is controllable based upon the position of

the wall switch.” As with the limitations previously discussed, this limitation is not taught or suggested by Ruskouski. Specifically, there is no teaching in Ruskouski that the light-emitting diodes will illuminate when the wall switch is turned to an open position. Accordingly, because this limitation is not taught or suggested by Ruskouski, this reference cannot render claims 25-27 *prima facie* obvious under 35 U.S.C. § 103(a). Withdrawal of this rejection is respectfully requested.

#### **VIII. Information Disclosure Statement**

The Examiner objected to the “Non-Patent Publications” section of the Information Disclosure Statement (“IDS”) that the Applicants filed on March 25, 2004. Applicants note that they have addressed the concerns raised by the Examiner with respect to this IDS and have resubmitted an IDS with the present submission. The appropriate fee as required by 37 C.F.R. 1.97(e) also accompanies this submission.

#### **IX. Conclusion**

Given the foregoing amendments and remarks, Applicants respectfully assert that all pending claims are patentably distinct from the cited references. As such, Applicants respectfully request that a timely Notice of Allowance be issued in this case. If there are any remaining issues preventing allowance of the pending claims that may be clarified by telephone, the Examiner is requested to call the undersigned. Likewise, with respect to any of the fees/charges associated with the present application, the Commissioner is instructed to credit any overpayments or charge any deficiencies to Deposit Account 13-0763.

Appl. No. 10/733,853  
Amdt. dated October 6, 2005  
Reply to Office Action of April 27, 2005

Respectfully submitted,

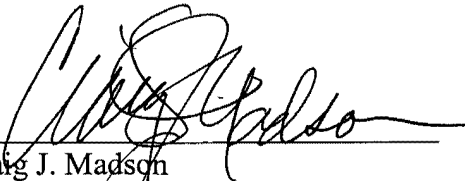

---

Craig J. Madson  
Reg. No. 29,407  
Attorney for Applicant

Date: October 6, 2005

MADSON & METCALF  
Gateway Tower West  
15 West South Temple, Suite 900  
Salt Lake City, Utah 84101  
Telephone: 801/537-1700

S:\ALLCLIENTS\3358 Hess & Nielson\3358.2.1\OA 4-27-05\Responseto27Apr05OfficeAction.doc

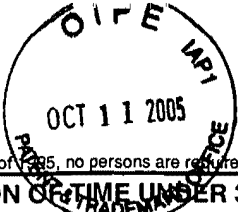

Under the Paperwork Reduction Act of 1995, no persons are required to respond to a collection of information unless it displays a valid OMB control number.

<b>PETITION FOR EXTENSION OF TIME UNDER 37 CFR 1.136(a)</b> FY 2005 (fees effective on or after October 1, 2004)	Docket Number (Optional) 3358.2.1
--	--------------------------------------

Application Number 10/733,853	Filed December 11, 2003
-------------------------------	-------------------------

For **LOW-VOLTAGE LIGHTING APPARATUS FOR SATISFYING AFTER-HOURS LIGHTING REQUIREMENTS, EMERGENCY LIGHTING REQUIREMENTS, AND LOW LIGHT REQUIREMENTS**

Group Art Unit 2875	Examiner Jason Han
---------------------	--------------------

This is a request under the provisions of 37 CFR 1.136(a) to extend the period for filing a response in the above identified application.

The requested extension and appropriate non-small-entity fee are as follows (check time period desired):

	Fee	Small Entity Fee	
<input type="checkbox"/> One month (37 CFR 1.17(a)(1))	\$120	\$60	\$ _____
<input type="checkbox"/> Two months (37 CFR 1.17(a)(2))	\$450	\$225	\$ _____
<input checked="" type="checkbox"/> Three months (37 CFR 1.17(a)(3))	\$1020	\$510	\$510.00
<input type="checkbox"/> Four months (37 CFR 1.17(a)(4))	\$1590	\$795	\$ _____
<input type="checkbox"/> Five months (37 CFR 1.17(a)(5))	\$2160	\$1080	\$ _____

- Applicant claims small entity status. See 37 CFR 1.27.
- A check in the amount of the fee is enclosed.
- Payment by credit card. Form PTO-2038 is attached.
- The Commissioner has already been authorized to charge fees in this application to a Deposit Account.
- The Commissioner is hereby authorized to charge any underpayment of the above fees, or credit any overpayment, to Deposit Account Number 13-0763. I have enclosed a duplicate copy of this sheet.

**WARNING: Information on this form may become public. Credit card information should not be included on this form. Provide credit card information and authorization on PTO-2038.**

- I am the  applicant/inventor.
- assignee of record of the entire interest. See 37 CFR 3.71  
Statement under 37 CFR 3.73(b) is enclosed. (Form PTO/SB/96).
  - attorney or agent of record. Registration Number: 29,407
  - attorney or agent under 37 CFR 1.34(a).

Registration number if acting under 37 CFR 1.34(a) \_\_\_\_\_

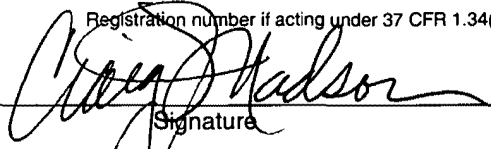
  
 \_\_\_\_\_  
 Signature  
 Craig J. Madson  
 \_\_\_\_\_  
 Name

October 6, 2005  
 \_\_\_\_\_  
 Date  
 (801) 537-1700  
 \_\_\_\_\_  
 Telephone Number

NOTE: Signatures of all the inventors or assignees of record of the entire interest or their representative(s) are required. Submit multiple forms if more than one signature is required, see below\*.

Total of 1 forms are submitted.

This collection of information is required by 37 CFR 1.136(a). The information is required to obtain or retain a benefit by the public which is to file (and the USPTO to process) an application. Confidentiality is governed by 35 U.S.C. 122 and 37 CFR 1.11 and 1.14. This collection is estimated to take minutes to complete, including gathering, preparing, and submitting the completed application form to the USPTO. Time will vary depending upon the individual case. Any comments on the amount of time you are required to complete this form and/or suggestions for reducing this burden, should be sent to the Chief Information Officer, U.S. Patent and Trademark Office, U.S. Department of Commerce, P.O. Box 1450, Alexandria, VA 22313-1450. DO NOT SEND FEES OR COMPLETED FORMS TO THIS ADDRESS. SEND TO: Commissioner for Patents, P.O. Box 1450, Alexandria, VA 22313-1450.

If you need assistance in completing this form, call 1-800-PTO-9199 and selection option 2.

10/12/2005 14:23:53 510.00 DP 01 FC:2253



**CERTIFICATE OF MAILING**

I hereby certify that this correspondence is being deposited with the United States Postal Service as first class mail in an envelope addressed to: Mail Stop Amendment, Commissioner for Patents, P.O. Box 1450, Alexandria, VA 22313-1450, on October 11, 2005.

Attorney for Applicants

**IN THE UNITED STATES PATENT AND TRADEMARK OFFICE**

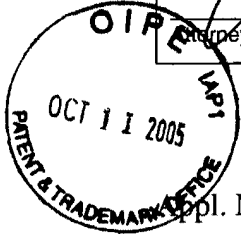

Appl. No. : 10/733,853  
Applicants : Lyman O. Nielson et al.  
Title : LOW-VOLTAGE LIGHTING APPARATUS  
FOR SATISFYING AFTER-HOURS  
LIGHTING REQUIREMENTS, EMERGENCY  
LIGHTING REQUIREMENTS, AND LOW  
LIGHT REQUIREMENTS  
Filed : December 11, 2003  
TC/A.U. : 2875  
Examiner : Jason Han  
Docket No. : 3358.2.1  
Customer No. : 21552

Mail Stop Amendment  
Commissioner for Patents  
P.O. Box 1450  
Alexandria, VA 22313-1450

**TRANSMITTAL OF SUPPLEMENTAL INFORMATION**  
**DISCLOSURE STATEMENT**

Dear Sir:

Transmitted herewith is an Information Disclosure Statement disclosing information which has come to the attention of applicants and/or their attorneys and is being submitted so as to comply with the duty of disclosure set forth in 37 C.F.R. § 1.56. In accordance with 37 C.F.R. § 1.97(c), the enclosed Statement is being filed before the mailing date of either a final action or a notice of allowance and is accompanied by credit card payment form in the amount of One Hundred Eighty Dollars (\$180.00) to cover the fee set forth in 37 C.F.R. § 1.17(p).

10/12/2005 WASFAW1 00000042 10733853

02 FC:1806

180.00 0P

Neither applicants nor their attorneys make any representation that any information disclosed herein may be "prior art" within the meaning of that term under 35 U.S.C. § 102 or § 103. Moreover, pursuant to 37 C.F.R. § 1.97, the filing of this Information Disclosure Statement shall not be construed as a representation that a search has been made or as an admission that the information cited herein is, or is considered to be, material to patentability as defined in 37 C.F.R. § 1.56(b).

In accordance with 37 C.F.R. § 1.98, transmitted herewith are:

1. A completed copy of Form PTO/SB08b "Information Disclosure Statement by Applicant" listing the patents, publications and other information being submitted for consideration; and
2. A legible copy of each patent, publication and other item of information in written form listed on the enclosed Form PTO/SB/08b, except for copies of U.S. patents and published U.S. patent applications which are not required for applications filed after June 30, 2003.

Respectfully submitted,

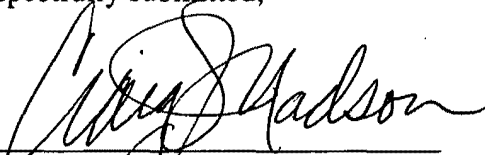

---

Craig J. Madson  
Reg. No. 29,407  
Attorney for Applicants

Date: October 6, 2005

MADSON & METCALF  
Gateway Tower West  
15 West South Temple, Suite 900  
Salt Lake City, Utah 84101  
Telephone: 801/537-1700

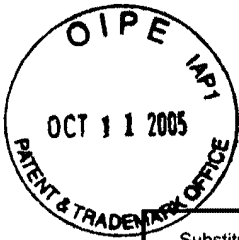

Under the Paperwork Reduction Act of 1995, no persons are required to respond to a collection of information unless it contains a valid OMB control number.

Substitute for form 1449B/PTO		<b>Complete if Known</b>	
<b>INFORMATION DISCLOSURE STATEMENT BY APPLICANT</b>		Application Number	10/733,853
		Filing Date	December 11, 2003
		First Named Inventor	Lyman O. Nielson
		Group Art Unit	2875
		Examiner Name	Jason Han
		Attorney Docket Number	3358.2.1
(use as many sheets as necessary)			
Sheet	1	Of	2

NON PATENT LITERATURE DOCUMENTS			
Examiner Initials *	Cite No. <sup>1</sup>	Include name of the author (in CAPITAL LETTERS), title of the article (when appropriate), title of the item (book, magazine, journal, serial, symposium, catalog, etc.), date, page(s), volume-issue number(s), publisher, city and/or country where published.	T <sup>2</sup>
	O1	DIMANGO, "Power Failure Night Light: Model HS9610", March 5, 2003, 2 pages, <a href="http://www.eztone.com/hs9610.htm">http://www.eztone.com/hs9610.htm</a> .	
	O2	FIRST ALERT, "Night Lights", March 5, 2003, 2 pages, <a href="http://www.firstalert.com/home_safety/night_lights/night_light_catalog.htm">http://www.firstalert.com/home_safety/night_lights/night_light_catalog.htm</a> .	
	O3	SAGE LIGHTING LTD., "LED Lighting Products", February 6, 2004, 3 pages.	
	O4	AUTHOR UNKNOWN, "SA358: Smoke Alarm with Emergency Light", February 6, 2004, 1 page.	
	O5	PRIMATECH SRL, "Gas and Smoke Detector: ESM-768 Semiconductor/Ionisation Technology", February 6, 2004, 2 pages, <a href="http://www.romgaz.com">http://www.romgaz.com</a> .	
	O6	STAR BATTERIES, "3 in 1 LED Emergency Light: Nexstar 3 in 1 Power Failure LED Emergency Light + LED Flashlight + Night Light", February 6, 2004, 3 pages.	
	O7	SAFE & SOUND, "Kiddie Ionization Smoke Alarm w/Exit Light", February 6, 2004, 1 page.	
	O8	GLOBAL INFORMATION, INC., "Light Emitting Diodes for Lighting Applications", February 6, 2004, 3 pages, <a href="http://www.the-infoshop.com">http://www.the-infoshop.com</a> .	
	O9	NATIONAL FIRE PROTECTION ASSOCIATION, "NFPA Fact Sheets: School, College, and University Dormitory, Fraternity and Sorority House Fires", February 6, 2004, 2 pages.	
	O10	AUTHOR UNKNOWN, "Homeowners Insurance: Rising Cost of Homeowners Insurance," February 6, 2004, 8 pages.	
	O11	NORLUX CORPORATION, "The LED Advantage", February 6, 2004, 2 pages.	
	O12	MARK KENDALL and MICHAEL SCHOLAND, "Energy Savings Potential of Solid State Lighting in General Lighting Applications" (Final Report), April 2001, 33 pages (Cover pages, pg. i-ii, pg. 3-31),	
	O13	STEVE JOHNSON, "The Solid State Lighting Initiative: An Industry/ DOE Collaborative Effort", October 2000, 6 pages (cover, pg.1-5), Nov./Dec. 2000 Issue, Architectural Lighting.	
	O14	LEDTRONICS, INC., "Energy Efficient, High Powered Accent & Area Lighting LED Light Strip Illuminator Module", October 2000, 1 page, <a href="http://www.ledtronics.com">http://www.ledtronics.com</a> .	
	O15	FIREFLY TECHNOLOGY CORPORATION, "World's First! Super Energy Efficient Solid-State Egress/Night Lighting", Copyright 2000, 2001, 2002 and 2003, 1 page, <a href="http://www.firefly-technology.com">http://www.firefly-technology.com</a> .	
	O16	OXLEY DEVELOPMENTS COMPANY, "Way Guidance Lighting Surviv Lite Emergency Egress Lighting", October 1999, 2 pages, <a href="http://www.oxleygroup.com">http://www.oxleygroup.com</a> .	
	O17	FIRST ALERT, "PowerFailure Night Light" (User Manual), Copyright 1997, 6 pages, <a href="http://www.firstalert.com">http://www.firstalert.com</a> .	
	O18	ARPAD A. BERGH, "A View on the Future of Solid State Lighting", IODA Optoelectronics Industry Development Association, Date Unknown, 6 pages.	
	O19	THE BODINE COMPANY, INC., "GTD™ Generator Transfer Device for Generator-Supplied Lighting", Date Unknown, 2 pages, <a href="http://www.bodine.com">http://www.bodine.com</a> .	

Examiner Signature	Date Considered
--------------------	-----------------

\* EXAMINER: Initial if reference considered, whether or not citation is in conformance with MPEP 609. Draw line through citation if not in conformance and not considered. Include copy of this form with next communication to applicant.

<sup>1</sup> Applicant's unique citation designation number (optional). <sup>2</sup> Applicant is to place a check mark here if English language Translation is attached.

This collection of information is required by 37 CFR 1.97 and 1.98. The information is required to obtain or retain a benefit by the public which is to file (and by the USPTO to process) an application. Confidentiality is governed by 35 U.S.C. 122 and 37 CFR 1.14. This collection is estimated to take 2 hours to complete, including gathering, preparing, and submitting the completed application form to the USPTO. Time will vary depending upon the individual case. Any comments on the amount of time you are required to complete this form and/or suggestions for reducing this burden, should be sent to the Chief Information Officer, U.S. Patent and Trademark Office, U.S. Department of Commerce, P.O. Box 1450, Alexandria, VA 22313-1450. DO NOT SEND FEES OR COMPLETED FORMS TO THIS ADDRESS. SEND TO: Commissioner for Patents, P.O. Box 1450, Alexandria, VA 22313-1450.

If you need assistance in completing this form, call 1-800-PTO-9199 and selection option 2.

Under the Paperwork Reduction Act of 1995, no persons are required to respond to a collection of information unless it contains a valid OMB control number.

Substitute for form 1449B/PTO  <b>INFORMATION DISCLOSURE STATEMENT BY APPLICANT</b>  <i>(use as many sheets as necessary)</i>  Sheet        2            Of            2	<b>Complete if Known</b>	
	Application Number	10/733,853
	Filing Date	December 11, 2003
	First Named Inventor	Lyman O. Nielson
	Group Art Unit	2875
	Examiner Name	Jason Han
	Attorney Docket Number	3358.2.1

	O20	FIREFLY TECHNOLOGY CORPORATION, "Down Light/ Night Light Strip", Date Unknown, 1 page.	
	O21	FIREFLY TECHNOLOGY CORPORATION, "Super Energy Efficient Solid-State Egress/ Night Lighting", Date Unknown, 1 page.	
	O22	AUTHOR UNKNOWN, "Egress Aisles-Exit Signs- Egress Lighting Requirements, Date Unknown, 2 pages.	

Examiner Signature		Date Considered	
--------------------	--	-----------------	--

<sup>1</sup> EXAMINER: Initial if reference considered, whether or not citation is in conformance with MPEP 609. Draw line through citation if not in conformance and not considered. Include copy of this form with next communication to applicant.

<sup>1</sup> Applicant's unique citation designation number (optional) . <sup>2</sup> Applicant is to place a check mark here if English language Translation is attached.

This collection of information is required by 37 CFR 1.97 and 1.98. The information is required to obtain or retain a benefit by the public which is to file (and by the USPTO to process) an application. Confidentiality is governed by 35 U.S.C. 122 and 37 CFR 1.14. This collection is estimated to take 2 hours to complete, including gathering, preparing, and submitting the completed application form to the USPTO. Time will vary depending upon the individual case. Any comments on the amount of time you are required to complete this form and/or suggestions for reducing this burden, should be sent to the Chief Information Officer, U.S. Patent and Trademark Office, U.S. Department of Commerce, P.O. Box 1450, Alexandria, VA 22313-1450. DO NOT SEND FEES OR COMPLETED FORMS TO THIS ADDRESS. SEND TO: Commissioner for Patents, P.O. Box 1450, Alexandria, VA 22313-1450.

If you need assistance in completing this form, call 1-800-PTO-9199 and selection option 2.

Under the Paperwork Reduction Act of 1995, no persons are required to respond to a collection of information unless it displays a valid OMB control number.

PATENT APPLICATION FEE DETERMINATION RECORD Substitute for Form PTO-875						Application or Docket Number <i>10/733853</i>				
APPLICATION AS FILED – PART I				SMALL ENTITY		OR OTHER THAN SMALL ENTITY				
(Column 1)		(Column 2)								
FOR	NUMBER FILED	NUMBER EXTRA		RATE (\$)	FEE (\$)		RATE (\$)			
BASIC FEE (37 CFR 1.16(a), (b), or (c))										
SEARCH FEE (37 CFR 1.16(k), (l), or (m))										
EXAMINATION FEE (37 CFR 1.16(o), (p), or (q))										
TOTAL CLAIMS (37 CFR 1.16(i))	minus 20 =	*		x <i>25</i> =			x <i>50</i> =			
INDEPENDENT CLAIMS (37 CFR 1.16(h))	minus 3 =	*		x <i>100</i> =			x <i>200</i> =			
APPLICATION SIZE FEE (37 CFR 1.16(s))	If the specification and drawings exceed 100 sheets of paper, the application size fee due is \$250 (\$125 for small entity) for each additional 50 sheets or fraction thereof. See 35 U.S.C. 41(a)(1)(G) and 37 CFR 1.16(s).									
MULTIPLE DEPENDENT CLAIM PRESENT (37 CFR 1.16(j))										
				+ <i>180</i>			+ <i>360</i>			
				TOTAL			TOTAL			
* If the difference in column 1 is less than zero, enter "0" in column 2.										
APPLICATION AS AMENDED – PART II										
(Column 1)		(Column 2)		(Column 3)		SMALL ENTITY		OR OTHER THAN SMALL ENTITY		
AMENDMENT A	<i>11/2/05</i>	CLAIMS REMAINING AFTER AMENDMENT		HIGHEST NUMBER PREVIOUSLY PAID FOR	PRESENT EXTRA	RATE (\$)	ADDITIONAL FEE (\$)	RATE (\$)	ADDITIONAL FEE (\$)	
	Total (37 CFR 1.16(i))	<i>32</i>	Minus	<i>32</i>	=	x <i>25</i> =		OR	x <del><i>50</i></del> =	
	Independent (37 CFR 1.16(h))	<i>3</i>	Minus	<i>4</i>	=	x <del><i>100</i></del> =		OR	x <del><i>200</i></del> =	
	Application Size Fee (37 CFR 1.16(s))									
	FIRST PRESENTATION OF MULTIPLE DEPENDENT CLAIM (37 CFR 1.16(j))						+ <i>180</i>		OR	+ <i>360</i>
				TOTAL				OR	TOTAL	
				ADD'L FEE				OR	ADD'L FEE	
AMENDMENT B		CLAIMS REMAINING AFTER AMENDMENT		HIGHEST NUMBER PREVIOUSLY PAID FOR	PRESENT EXTRA	RATE (\$)	ADDITIONAL FEE (\$)	RATE (\$)	ADDITIONAL FEE (\$)	
	Total (37 CFR 1.16(i))	*	Minus	**	=	x <i>25</i> =		OR	x <i>50</i> =	
	Independent (37 CFR 1.16(h))	*	Minus	***	=	x <del><i>100</i></del> =		OR	x <del><i>200</i></del> =	
	Application Size Fee (37 CFR 1.16(s))									
	FIRST PRESENTATION OF MULTIPLE DEPENDENT CLAIM (37 CFR 1.16(j))						+ <i>180</i>		OR	+ <i>360</i>
				TOTAL				OR	TOTAL	
				ADD'L FEE				OR	ADD'L FEE	
* If the entry in column 1 is less than the entry in column 2, write "0" in column 3. ** If the "Highest Number Previously Paid For" IN THIS SPACE is less than 20, enter "20". *** If the "Highest Number Previously Paid For" IN THIS SPACE is less than 3, enter "3". The "Highest Number Previously Paid For" (Total or Independent) is the highest number found in the appropriate box in column 1.										

This collection of information is required by 37 CFR 1.16. The information is required to obtain or retain a benefit by the public which is to file (and by the USPTO to process) an application. Confidentiality is governed by 35 U.S.C. 122 and 37 CFR 1.14. This collection is estimated to take 12 minutes to complete, including gathering, preparing, and submitting the completed application form to the USPTO. Time will vary depending upon the individual case. Any comments on the amount of time you require to complete this form and/or suggestions for reducing this burden, should be sent to the Chief Information Officer, U.S. Patent and Trademark Office, U.S. Department of Commerce, P.O. Box 1450, Alexandria, VA 22313-1450. DO NOT SEND FEES OR COMPLETED FORMS TO THIS ADDRESS. SEND TO: Commissioner for Patents, P.O. Box 1450, Alexandria, VA 22313-1450.

If you need assistance in completing the form, call 1-800-PTO-9199 and select option 2.

Claim		Date			
Final	Original				
1					
2					
3					
4					
5					
6					
7					
8					
9					
10					
11					
12					
13					
14					
15					
16					
17					
18					
19					
20					
21					
22					
23					
24					
25					
26					
27					
28					
29					
30					
31					
32					
33					
34					
35					
36					
37					
38					
39					
40					
41					
42					
43					
44					
45					
46					
47					
48					
49					
50					

Claim		Date			
Final	Original				
51					
52					
53					
54					
55					
56					
57					
58					
59					
60					
61					
62					
63					
64					
65					
66					
67					
68					
69					
70					
71					
72					
73					
74					
75					
76					
77					
78					
79					
80					
81					
82					
83					
84					
85					
86					
87					
88					
89					
90					
91					
92					
93					
94					
95					
96					
97					
98					
99					
100					

Claim		Date			
Final	Original				
101					
102					
103					
104					
105					
106					
107					
108					
109					
110					
111					
112					
113					
114					
115					
116					
117					
118					
119					
120					
121					
122					
123					
124					
125					
126					
127					
128					
129					
130					
131					
132					
133					
134					
135					
136					
137					
138					
139					
140					
141					
142					
143					
144					
145					
146					
147					
148					
149					
150					

If more than 160 claims or 10 actions  
staple additional sheet here

(LEFT INSIDE)

Ref #	Hits	Search Query	DBs	Default Operator	Plurals	Time Stamp
S76	1716	(circuit adj board or PCB) and (light adj emitting or LED) and wall with switch\$4	US-PGPUB; USPAT; USOCR; EPO; JPO; DERWENT	OR	ON	2006/01/12 18:41
S77	790	(circuit adj board or PCB) same (light adj emitting or LED) and wall with switch\$4	US-PGPUB; USPAT; USOCR; EPO; JPO; DERWENT	OR	ON	2006/01/12 19:18
S78	80	(circuit adj board or PCB) same (light adj emitting or LED) and wall adj switch\$4	US-PGPUB; USPAT; USOCR; EPO; JPO; DERWENT	OR	ON	2006/01/12 19:24
S81	110	("40".clas. or "362".clas.) and wall with switch\$4 and (circuit adj board or PCB) with (light adj emitting or LED)	US-PGPUB; USPAT; USOCR; EPO; JPO; DERWENT	OR	ON	2006/01/12 19:32
S80	1127	("40".clas. or "362".clas.) and switch\$4 and (circuit adj board or PCB) with (light adj emitting or LED)	US-PGPUB; USPAT; USOCR; EPO; JPO; DERWENT	OR	ON	2006/01/12 19:32
S79	349	(362/20.ccls. or 362/228.ccls. or 362/240.ccls. or 362/249.ccls. or 362/251.ccls. or 362/800.ccls.) and switch\$4 and (circuit adj board or PCB) with (light adj emitting or LED)	US-PGPUB; USPAT; USOCR; EPO; JPO; DERWENT	OR	ON	2006/01/12 19:32
L14	34	("2476517"   "2715197"   "2946903"   "3032688"   "3422309"   "3500455"   "3659179"   "3935505"   "4349863"   "4727291"   "4733335"   "4985661"   "5655830"   "5734229"   "5752766"   "5848837"   "6016038"   "6149283"   "6163038"   "6203180"   "6218785"   "6220722"   "6227679"   "6250774"   "6268801"   "6367949"   "6431728").PN. OR ("6609804").URPN.	US-PGPUB; USPAT; USOCR	OR	ON	2006/01/13 11:36

L18	19	("20020191386"   "2089226"   "2597680"   "3604916"   "4092528"   "4386391"   "4654629"   "4814667"   "4943900"   "5057985"   "5103382"   "5416679"   "5642934"   "5934798"   "6158882"   "6347880"   "6582103").PN. OR ("6726348"). URPN.	US-PGPUB; USPAT; USOCR	OR	ON	2006/01/13 11:38
-----	----	--	------------------------------	----	----	------------------



## Interference Search

Ref #	Hits	Search Query	DBs	Default Operator	Plurals	Time Stamp
L21	0	((PCB or circuit adj board) with (LED or light adj emitting) same wall adj switch).CLM.	US-PGPUB	OR	ON	2006/01/13 11:57
L22	80	((PCB or circuit adj board) with (LED or light adj emitting) same switch\$4).CLM.	US-PGPUB	OR	ON	2006/01/13 11:58



UNITED STATES DEPARTMENT OF COMMERCE
United States Patent and Trademark Office
Address: COMMISSIONER FOR PATENTS
P.O. Box 1450
Alexandria, Virginia 22313-1450
www.uspto.gov

NOTICE OF ALLOWANCE AND FEE(S) DUE

21552 7590 01/25/2006
MADSON & AUSTIN
GATEWAY TOWER WEST
SUITE 900
15 WEST SOUTH TEMPLE
SALT LAKE CITY, UT 84101

EXAMINER

HAN, JASON

ART UNIT PAPER NUMBER

2875

DATE MAILED: 01/25/2006

Table with 5 columns: APPLICATION NO., FILING DATE, FIRST NAMED INVENTOR, ATTORNEY DOCKET NO., CONFIRMATION NO.

10/733,853 12/11/2003 Lyman O. Nielson 3358.2.1 9007

TITLE OF INVENTION: LOW-VOLTAGE LIGHTING APPARATUS FOR SATISFYING AFTER-HOURS LIGHTING REQUIREMENTS, EMERGENCY LIGHTING REQUIREMENTS, AND LOW LIGHT REQUIREMENTS

Table with 6 columns: APPLN. TYPE, SMALL ENTITY, ISSUE FEE, PUBLICATION FEE, TOTAL FEE(S) DUE, DATE DUE

nonprovisional YES \$700 \$300 \$1000 04/25/2006

THE APPLICATION IDENTIFIED ABOVE HAS BEEN EXAMINED AND IS ALLOWED FOR ISSUANCE AS A PATENT. PROSECUTION ON THE MERITS IS CLOSED. THIS NOTICE OF ALLOWANCE IS NOT A GRANT OF PATENT RIGHTS. THIS APPLICATION IS SUBJECT TO WITHDRAWAL FROM ISSUE AT THE INITIATIVE OF THE OFFICE OR UPON PETITION BY THE APPLICANT. SEE 37 CFR 1.313 AND MPEP 1308.

THE ISSUE FEE AND PUBLICATION FEE (IF REQUIRED) MUST BE PAID WITHIN THREE MONTHS FROM THE MAILING DATE OF THIS NOTICE OR THIS APPLICATION SHALL BE REGARDED AS ABANDONED. THIS STATUTORY PERIOD CANNOT BE EXTENDED. SEE 35 U.S.C. 151. THE ISSUE FEE DUE INDICATED ABOVE REFLECTS A CREDIT FOR ANY PREVIOUSLY PAID ISSUE FEE APPLIED IN THIS APPLICATION. THE PTOL-85B (OR AN EQUIVALENT) MUST BE RETURNED WITHIN THIS PERIOD EVEN IF NO FEE IS DUE OR THE APPLICATION WILL BE REGARDED AS ABANDONED.

HOW TO REPLY TO THIS NOTICE:

I. Review the SMALL ENTITY status shown above.

If the SMALL ENTITY is shown as YES, verify your current SMALL ENTITY status:

A. If the status is the same, pay the TOTAL FEE(S) DUE shown above.

B. If the status above is to be removed, check box 5b on Part B - Fee(s) Transmittal and pay the PUBLICATION FEE (if required) and twice the amount of the ISSUE FEE shown above, or

If the SMALL ENTITY is shown as NO:

A. Pay TOTAL FEE(S) DUE shown above, or

B. If applicant claimed SMALL ENTITY status before, or is now claiming SMALL ENTITY status, check box 5a on Part B - Fee(s) Transmittal and pay the PUBLICATION FEE (if required) and 1/2 the ISSUE FEE shown above.

II. PART B - FEE(S) TRANSMITTAL should be completed and returned to the United States Patent and Trademark Office (USPTO) with your ISSUE FEE and PUBLICATION FEE (if required). Even if the fee(s) have already been paid, Part B - Fee(s) Transmittal should be completed and returned. If you are charging the fee(s) to your deposit account, section "4b" of Part B - Fee(s) Transmittal should be completed and an extra copy of the form should be submitted.

III. All communications regarding this application must give the application number. Please direct all communications prior to issuance to Mail Stop ISSUE FEE unless advised to the contrary.

IMPORTANT REMINDER: Utility patents issuing on applications filed on or after Dec. 12, 1980 may require payment of maintenance fees. It is patentee's responsibility to ensure timely payment of maintenance fees when due.

**PART B - FEE(S) TRANSMITTAL**

Complete and send this form, together with applicable fee(s), to: **Mail** **Mail Stop ISSUE FEE**  
**Commissioner for Patents**  
**P.O. Box 1450**  
**Alexandria, Virginia 22313-1450**  
 or **Fax** **(571) 273-2885**

**INSTRUCTIONS:** This form should be used for transmitting the ISSUE FEE and PUBLICATION FEE (if required). Blocks 1 through 5 should be completed where appropriate. All further correspondence including the Patent, advance orders and notification of maintenance fees will be mailed to the current correspondence address as indicated unless corrected below or directed otherwise in Block 1, by (a) specifying a new correspondence address; and/or (b) indicating a separate "FEE ADDRESS" for maintenance fee notifications.

CURRENT CORRESPONDENCE ADDRESS (Note: Use Block 1 for any change of address)

Note: A certificate of mailing can only be used for domestic mailings of the Fee(s) Transmittal. This certificate cannot be used for any other accompanying papers. Each additional paper, such as an assignment or formal drawing, must have its own certificate of mailing or transmission.

21552                      7590                      01/25/2006

**MADSON & AUSTIN**  
**GATEWAY TOWER WEST**  
**SUITE 900**  
**15 WEST SOUTH TEMPLE**  
**SALT LAKE CITY, UT 84101**

**Certificate of Mailing or Transmission**

I hereby certify that this Fee(s) Transmittal is being deposited with the United States Postal Service with sufficient postage for first class mail in an envelope addressed to the Mail Stop ISSUE FEE address above, or being facsimile transmitted to the USPTO (571) 273-2885, on the date indicated below.

(Depositor's name)
(Signature)
(Date)

APPLICATION NO.	FILING DATE	FIRST NAMED INVENTOR	ATTORNEY DOCKET NO.	CONFIRMATION NO.
10/733,853	12/11/2003	Lyman O. Nielson	3358.2.1	9007

**TITLE OF INVENTION: LOW-VOLTAGE LIGHTING APPARATUS FOR SATISFYING AFTER-HOURS LIGHTING REQUIREMENTS, EMERGENCY LIGHTING REQUIREMENTS, AND LOW LIGHT REQUIREMENTS**

APPLN. TYPE	SMALL ENTITY	ISSUE FEE	PUBLICATION FEE	TOTAL FEE(S) DUE	DATE DUE
nonprovisional	YES	\$700	\$300	\$1000	04/25/2006

EXAMINER	ART UNIT	CLASS-SUBCLASS
HAN, JASON	2875	362-020000

<p>1. Change of correspondence address or indication of "Fee Address" (37 CFR 1.363).</p> <p><input type="checkbox"/> Change of correspondence address (or Change of Correspondence Address form PTO/SB/122) attached.</p> <p><input type="checkbox"/> "Fee Address" indication (or "Fee Address" Indication form PTO/SB/47; Rev 03-02 or more recent) attached. Use of a Customer Number is required.</p>	<p>2. For printing on the patent front page, list</p> <p>(1) the names of up to 3 registered patent attorneys or agents OR, alternatively, _____ 1</p> <p>(2) the name of a single firm (having as a member a registered attorney or agent) and the names of up to 2 registered patent attorneys or agents. If no name is listed, no name will be printed. _____ 2</p> <p>_____ 3</p>
--	---

3. ASSIGNEE NAME AND RESIDENCE DATA TO BE PRINTED ON THE PATENT (print or type)

PLEASE NOTE: Unless an assignee is identified below, no assignee data will appear on the patent. If an assignee is identified below, the document has been filed for recordation as set forth in 37 CFR 3.11. Completion of this form is NOT a substitute for filing an assignment.

(A) NAME OF ASSIGNEE \_\_\_\_\_ (B) RESIDENCE: (CITY and STATE OR COUNTRY) \_\_\_\_\_

Please check the appropriate assignee category or categories (will not be printed on the patent):  Individual  Corporation or other private group entity  Government

<p>4a. The following fee(s) are enclosed:</p> <p><input type="checkbox"/> Issue Fee</p> <p><input type="checkbox"/> Publication Fee (No small entity discount permitted)</p> <p><input type="checkbox"/> Advance Order - # of Copies _____</p>	<p>4b. Payment of Fee(s):</p> <p><input type="checkbox"/> A check in the amount of the fee(s) is enclosed.</p> <p><input type="checkbox"/> Payment by credit card. Form PTO-2038 is attached.</p> <p><input type="checkbox"/> The Director is hereby authorized by charge the required fee(s), or credit any overpayment, to Deposit Account Number _____ (enclose an extra copy of this form).</p>
--	---

5. Change in Entity Status (from status indicated above)

a. Applicant claims SMALL ENTITY status. See 37 CFR 1.27.       b. Applicant is no longer claiming SMALL ENTITY status. See 37 CFR 1.27(g)(2).

The Director of the USPTO is requested to apply the Issue Fee and Publication Fee (if any) or to re-apply any previously paid issue fee to the application identified above. NOTE: The Issue Fee and Publication Fee (if required) will not be accepted from anyone other than the applicant; a registered attorney or agent; or the assignee or other party in interest as shown by the records of the United States Patent and Trademark Office.

Authorized Signature \_\_\_\_\_ Date \_\_\_\_\_

Typed or printed name \_\_\_\_\_ Registration No. \_\_\_\_\_

This collection of information is required by 37 CFR 1.311. The information is required to obtain or retain a benefit by the public which is to file (and by the USPTO to process) an application. Confidentiality is governed by 35 U.S.C. 122 and 37 CFR 1.14. This collection is estimated to take 12 minutes to complete, including gathering, preparing, and submitting the completed application form to the USPTO. Time will vary depending upon the individual case. Any comments on the amount of time you require to complete this form and/or suggestions for reducing this burden, should be sent to the Chief Information Officer, U.S. Patent and Trademark Office, U.S. Department of Commerce, P.O. Box 1450, Alexandria, Virginia 22313-1450. DO NOT SEND FEES OR COMPLETED FORMS TO THIS ADDRESS. SEND TO: Commissioner for Patents, P.O. Box 1450, Alexandria, Virginia 22313-1450.

Under the Paperwork Reduction Act of 1995, no persons are required to respond to a collection of information unless it displays a valid OMB control number.



UNITED STATES PATENT AND TRADEMARK OFFICE

UNITED STATES DEPARTMENT OF COMMERCE
United States Patent and Trademark Office
Address: COMMISSIONER FOR PATENTS
P.O. Box 1450
Alexandria, Virginia 22313-1450
www.uspto.gov

Table with 5 columns: APPLICATION NO., FILING DATE, FIRST NAMED INVENTOR, ATTORNEY DOCKET NO., CONFIRMATION NO.

21552 7590 01/25/2006
MADSON & AUSTIN
GATEWAY TOWER WEST
SUITE 900
15 WEST SOUTH TEMPLE
SALT LAKE CITY, UT 84101

EXAMINER
HAN, JASON

ART UNIT 2875
PAPER NUMBER

DATE MAILED: 01/25/2006

Determination of Patent Term Adjustment under 35 U.S.C. 154 (b)
(application filed on or after May 29, 2000)

The Patent Term Adjustment to date is 0 day(s). If the issue fee is paid on the date that is three months after the mailing date of this notice and the patent issues on the Tuesday before the date that is 28 weeks (six and a half months) after the mailing date of this notice, the Patent Term Adjustment will be 0 day(s).

If a Continued Prosecution Application (CPA) was filed in the above-identified application, the filing date that determines Patent Term Adjustment is the filing date of the most recent CPA.

Applicant will be able to obtain more detailed information by accessing the Patent Application Information Retrieval (PAIR) WEB site (http://pair.uspto.gov).

Any questions regarding the Patent Term Extension or Adjustment determination should be directed to the Office of Patent Legal Administration at (571) 272-7702. Questions relating to issue and publication fee payments should be directed to the Customer Service Center of the Office of Patent Publication at (703) 305-8283.

**Notice of Allowability**

Application No.	Applicant(s)	
10/733,853	NIELSON ET AL.	
Examiner	Art Unit	
Jason M. Han	2875	

-- The MAILING DATE of this communication appears on the cover sheet with the correspondence address--

All claims being allowable, PROSECUTION ON THE MERITS IS (OR REMAINS) CLOSED in this application. If not included herewith (or previously mailed), a Notice of Allowance (PTOL-85) or other appropriate communication will be mailed in due course. **THIS NOTICE OF ALLOWABILITY IS NOT A GRANT OF PATENT RIGHTS.** This application is subject to withdrawal from issue at the initiative of the Office or upon petition by the applicant. See 37 CFR 1.313 and MPEP 1308.

1.  This communication is responsive to amendment filed 11 October 2005 and telephone interview w/ amendment on 19 January 2006.

2.  The allowed claim(s) is/are 1-32.

3.  Acknowledgment is made of a claim for foreign priority under 35 U.S.C. § 119(a)-(d) or (f).

a)  All b)  Some\* c)  None of the:

1.  Certified copies of the priority documents have been received.

2.  Certified copies of the priority documents have been received in Application No. \_\_\_\_\_.

3.  Copies of the certified copies of the priority documents have been received in this national stage application from the International Bureau (PCT Rule 17.2(a)).

\* Certified copies not received: \_\_\_\_\_.

Applicant has THREE MONTHS FROM THE "MAILING DATE" of this communication to file a reply complying with the requirements noted below. Failure to timely comply will result in ABANDONMENT of this application.  
**THIS THREE-MONTH PERIOD IS NOT EXTENDABLE.**

4.  A SUBSTITUTE OATH OR DECLARATION must be submitted. Note the attached EXAMINER'S AMENDMENT or NOTICE OF INFORMAL PATENT APPLICATION (PTO-152) which gives reason(s) why the oath or declaration is deficient.

5.  CORRECTED DRAWINGS ( as "replacement sheets") must be submitted.

(a)  including changes required by the Notice of Draftsperson's Patent Drawing Review ( PTO-948) attached

1)  hereto or 2)  to Paper No./Mail Date \_\_\_\_\_.

(b)  including changes required by the attached Examiner's Amendment / Comment or in the Office action of Paper No./Mail Date \_\_\_\_\_.

Identifying indicia such as the application number (see 37 CFR 1.84(c)) should be written on the drawings in the front (not the back) of each sheet. Replacement sheet(s) should be labeled as such in the header according to 37 CFR 1.121(d).

6.  DEPOSIT OF and/or INFORMATION about the deposit of BIOLOGICAL MATERIAL must be submitted. Note the attached Examiner's comment regarding REQUIREMENT FOR THE DEPOSIT OF BIOLOGICAL MATERIAL.

**Attachment(s)**

1.  Notice of References Cited (PTO-892)

2.  Notice of Draftsperson's Patent Drawing Review (PTO-948)

3.  Information Disclosure Statements (PTO-1449 or PTO/SB/08),  
Paper No./Mail Date 20051011

4.  Examiner's Comment Regarding Requirement for Deposit  
of Biological Material

5.  Notice of Informal Patent Application (PTO-152)

6.  Interview Summary (PTO-413),  
Paper No./Mail Date 20060119.

7.  Examiner's Amendment/Comment

8.  Examiner's Statement of Reasons for Allowance

9.  Other \_\_\_\_\_.

**DETAILED ACTION**

**EXAMINER'S AMENDMENT**

1. An examiner's amendment to the record appears below. Should the changes and/or additions be unacceptable to applicant, an amendment may be filed as provided by 37 CFR 1.312. To ensure consideration of such an amendment, it **MUST** be submitted no later than the payment of the issue fee.

Authorization for this examiner's amendment was given in a telephone interview with Craig J. Madson on January 19, 2006.

The application has been amended as follows in order to resolve 112 issues:

- a. Claim 12, Line 10: Delete "ballast cover" and replace with -- illumination surface --
- b. Claim 23, Line 2: Delete "a ballast" and replace with -- an illumination --
- c. Claim 23, Line 3: Delete "ballast cover" and replace with -- illumination surface --
- d. Claim 29, Line 9: Delete "ballast cover" and replace with -- illumination surface --

*Allowable Subject Matter*

2. Claims 1-32 are allowed.

3. The following is an examiner's statement of reasons for allowance:

With regard to Independent Claims 1, 12, 25, and 29, the Applicant has sufficiently amended and narrowly defined a lighting apparatus or method therefor, wherein a circuit board with a plurality of light emitting diodes is positioned adjacent a ballast cover/housing so that the plurality of light emitting diodes protrude through a plurality of cover/surface holes in the ballast cover/housing, and whereby the lighting apparatus is coupled to a wall switch so that the illumination of the light emitting diodes is controllable based upon the position of said switch. The prior art of record fails to teach or suggest the combination of structural elements, specifically the ballast/housing with a plurality of LEDs protruding therethrough being controllable by a wall switch, claimed herein, and all subsequent dependent claims are allowed.

Art Unit: 2875

Any comments considered necessary by applicant must be submitted no later than the payment of the issue fee and, to avoid processing delays, should preferably accompany the issue fee. Such submissions should be clearly labeled "Comments on Statement of Reasons for Allowance."

*Conclusion*

Any inquiry concerning this communication or earlier communications from the examiner should be directed to Jason M. Han whose telephone number is (571) 272-2207. The examiner can normally be reached on 8:00am-5:00pm.

If attempts to reach the examiner by telephone are unsuccessful, the examiner's supervisor, Sandra O'Shea can be reached on (571) 272-2378. The fax phone number for the organization where this application or proceeding is assigned is 571-273-8300.

Information regarding the status of an application may be obtained from the Patent Application Information Retrieval (PAIR) system. Status information for published applications may be obtained from either Private PAIR or Public PAIR. Status information for unpublished applications is available through Private PAIR only. For more information about the PAIR system, see <http://pair-direct.uspto.gov>. Should you have questions on access to the Private PAIR system, contact the Electronic Business Center (EBC) at 866-217-9197 (toll-free).

JMH (1/13/2006)

  
ALAN CARIASO  
PRIMARY EXAMINER

<b>Examiner-Initiated Interview Summary</b>	Application No. 10/733,853	Applicant(s) NIELSON ET AL.
	Examiner Jason M. Han	Art Unit 2875

**All Participants:**

(1) Craig J. Madson.

(2) Jason M. Han.

**Status of Application: After Non-Final**

(3) \_\_\_\_\_.

(4) \_\_\_\_\_.

**Date of Interview: 19 January 2006**

**Time: 5pm EST**

**Type of Interview:**

- Telephonic  
 Video Conference  
 Personal (Copy given to:  Applicant  Applicant's representative)

Exhibit Shown or Demonstrated:  Yes  No

If Yes, provide a brief description:

**Part I.**

Rejection(s) discussed:

*None*

Claims discussed:

*12, 23, 29*

Prior art documents discussed:

*None*

**Part II.**

**SUBSTANCE OF INTERVIEW DESCRIBING THE GENERAL NATURE OF WHAT WAS DISCUSSED:**

*Applicant agreed to amend the abovementioned claims to resolve 112 issues.*

**Part III.**

- It is not necessary for applicant to provide a separate record of the substance of the interview, since the interview directly resulted in the allowance of the application. The examiner will provide a written summary of the substance of the interview in the Notice of Allowability.  
 It is not necessary for applicant to provide a separate record of the substance of the interview, since the interview did not result in resolution of all issues. A brief summary by the examiner appears in Part II above.

\_\_\_\_\_  
(Examiner/SPE Signature)

\_\_\_\_\_  
(Applicant/Applicant's Representative Signature – if appropriate)





PTO/SB/08b (08-03)

Approved for use through 06/30/2008. OMB 0651-0031  
U.S. Patent and Trademark Office: U.S. DEPARTMENT OF COMMERCE

Under the Paperwork Reduction Act of 1995, no persons are required to respond to a collection of information unless it contains a valid OMB control number.

Substitute for form 1449B/PTO		<b>Complete if Known</b>	
<b>INFORMATION DISCLOSURE STATEMENT BY APPLICANT</b>  (use as many sheets as necessary)		Application Number	10/733,853
		Filing Date	December 11, 2003
		First Named Inventor	Lyman O. Nielson
		Group Art Unit	2875
		Examiner Name	Jason Han
		Attorney Docket Number	3358.2.1
		Sheet 1 Of 2	

NON PATENT LITERATURE DOCUMENTS			
Examiner Initials *	Cite No. <sup>1</sup>	Include name of the author (in CAPITAL LETTERS), title of the article (when appropriate), title of the item (book, magazine, journal, serial, symposium, catalog, etc.), date, page(s), volume-issue number(s), publisher, city and/or country where published.	T <sup>2</sup>
JMH	O1	DIMANGO, "Power Failure Night Light: Model HS9610", March 5, 2003, 2 pages, <a href="http://www.eztone.com/hs9610.htm">http://www.eztone.com/hs9610.htm</a> .	
JMH	O2	FIRST ALERT, "Night Lights", March 5, 2003, 2 pages, <a href="http://www.firstalert.com/home_safety/night_lights/night_light_catalog.htm">http://www.firstalert.com/home_safety/night_lights/night_light_catalog.htm</a> .	
JMH	O3	SAGE LIGHTING LTD., "LED Lighting Products", February 6, 2004, 3 pages.	
JMH	O4	AUTHOR UNKNOWN, "SA358: Smoke Alarm with Emergency Light", February 6, 2004, 1 page.	
JMH	O5	PRIMATECH SRL, "Gas and Smoke Detector: ESM-768 Semiconductor/Ionisation Technology", February 6, 2004, 2 pages, <a href="http://www.romqaz.com">http://www.romqaz.com</a> .	
JMH	O6	STAR BATTERIES, "3 in 1 LED Emergency Light: Nexstar 3 in 1 Power Failure LED Emergency Light + LED Flashlight + Night Light", February 6, 2004, 3 pages.	
JMH	O7	SAFE & SOUND, "Kidde Ionization Smoke Alarm w/Exit Light", February 6, 2004, 1 page.	
JMH	O8	GLOBAL INFORMATION, INC., "Light Emitting Diodes for Lighting Applications", February 6, 2004, 3 pages; <a href="http://www.the-infoshop.com">http://www.the-infoshop.com</a> .	
JMH	O9	NATIONAL FIRE PROTECTION ASSOCIATION, "NFPA Fact Sheets: School, College, and University Dormitory, Fraternity and Sorority House Fires", February 6, 2004, 2 pages.	
JMH	O10	AUTHOR UNKNOWN, "Homeowners Insurance: Rising Cost of Homeowners Insurance," February 6, 2004, 8 pages.	
JMH	O11	NORLUX CORPORATION, "The LED Advantage", February 6, 2004, 2 pages.	
JMH	O12	MARK KENDALL and MICHAEL SCHOLAND, "Energy Savings Potential of Solid State Lighting in General Lighting Applications" (Final Report), April 2001, 33 pages (Cover pages, pg. i-ii, pg. 3-31).	
JMH	O13	STEVE JOHNSON, "The Solid State Lighting Initiative: An Industry/ DOE Collaborative Effort", October 2000, 6 pages (cover, pg. 1-5), Nov./Dec. 2000 Issue, Architectural Lighting.	
JMH	O14	LEDTRONICS, INC., "Energy Efficient, High Powered Accent & Area Lighting LED Light Strip Illuminator Module", October 2000, 1 page, <a href="http://www.ledtronics.com">http://www.ledtronics.com</a> .	
JMH	O15	FIREFLY TECHNOLOGY CORPORATION, "World's First! Super Energy Efficient Solid-State Egress/Night Lighting", Copyright 2000, 2001, 2002 and 2003, 1 page, <a href="http://www.firefly-technology.com">http://www.firefly-technology.com</a> .	
JMH	O16	OXLEY DEVELOPMENTS COMPANY, "Way Guidance Lighting Surviv Lite Emergency Egress Lighting", October 1999, 2 pages, <a href="http://www.oxleygroup.com">http://www.oxleygroup.com</a> .	
JMH	O17	FIRST ALERT, "PowerFailure Night Light" (User Manual), Copyright 1997, 6 pages, <a href="http://www.firstalert.com">http://www.firstalert.com</a> .	
JMH	O18	ARPAD A. BERGH, "A View on the Future of Solid State Lighting", IODA Optoelectronics Industry Development Association, Date Unknown, 6 pages.	
JMH	O19	THE BODINE COMPANY, INC., "GTD™ Generator Transfer Device for Generator-Supplied Lighting", Date Unknown, 2 pages, <a href="http://www.bodine.com">http://www.bodine.com</a> .	

Examiner Signature		Date Considered	January 13, 2006
--------------------	--	-----------------	------------------

EXAMINER: Initial if reference considered, whether or not citation is in conformance with MPEP 609. Draw line through citation if not in conformance and not considered. Include copy of this form with next communication to applicant.

<sup>1</sup> Applicant's unique citation designation number (optional). <sup>2</sup> Applicant is to place a check mark here if English language Translation is attached.

This collection of information is required by 37 CFR 1.97 and 1.98. The information is required to obtain or retain a benefit by the public which is to file (and by the USPTO to process) an application. Confidentiality is governed by 35 U.S.C. 122 and 37 CFR 1.14. This collection is estimated to take 2 hours to complete, including gathering, preparing, and submitting the completed application form to the USPTO. Time will vary depending upon the individual case. Any comments on the amount of time you are required to complete this form and/or suggestions for reducing this burden, should be sent to the Chief Information Officer, U.S. Patent and Trademark Office, U.S. Department of Commerce, P.O. Box 1450, Alexandria, VA 22313-1450. DO NOT SEND FEES OR COMPLETED FORMS TO THIS ADDRESS. SEND TO: Commissioner for Patents, P.O. Box 1450, Alexandria, VA 22313-1450.

If you need assistance in completing this form, call 1-800-PTO-9199 and selection option 2.

Under the Paperwork Reduction Act of 1995, no persons are required to respond to a collection of information unless it contains a valid OMB control number.

Substitute for form 1449B/PTO		<b>Complete If Known</b>	
<b>INFORMATION DISCLOSURE STATEMENT BY APPLICANT</b>  (use as many sheets as necessary)		Application Number	10/733,853
		Filing Date	December 11, 2003
		First Named Inventor	Lyman O. Nielson
		Group Art Unit	2875
		Examiner Name	Jason Han
		Attorney Docket Number	3358.2.1
Sheet	2	Of	2

JMH	O20	FIREFLY TECHNOLOGY CORPORATION, "Down Light/ Night Light Strip", Date Unknown, 1 page.	
JMH	O21	FIREFLY TECHNOLOGY CORPORATION, "Super Energy Efficient Solid-State Egress/ Night Lighting", Date Unknown, 1 page.	
JMH	O22	AUTHOR UNKNOWN, "Egress Aisles-Exit Signs- Egress Lighting Requirements, Date Unknown, 2 pages.	

Examiner Signature		Date Considered	January 13, 2006
-----------------------	---	--------------------	------------------

<sup>1</sup> EXAMINER: Initial reference considered, whether or not citation is in conformance with MPEP 609. Draw line through citation if not in conformance and not considered. Include copy of this form with next communication to applicant.

<sup>1</sup> Applicant's unique citation designation number (optional). <sup>2</sup> Applicant is to place a check mark here if English language Translation is attached.

This collection of information is required by 37 CFR 1.97 and 1.98. The information is required to obtain or retain a benefit by the public which is to file (and by the USPTO to process) an application. Confidentiality is governed by 35 U.S.C. 122 and 37 CFR 1.14. This collection is estimated to take 2 hours to complete, including gathering, preparing, and submitting the completed application form to the USPTO. Time will vary depending upon the individual case. Any comments on the amount of time you are required to complete this form and/or suggestions for reducing this burden, should be sent to the Chief Information Officer, U.S. Patent and Trademark Office, U.S. Department of Commerce, P.O. Box 1450, Alexandria, VA 22313-1450. DO NOT SEND FEES OR COMPLETED FORMS TO THIS ADDRESS. SEND TO: Commissioner for Patents, P.O. Box 1450, Alexandria, VA 22313-1450.

If you need assistance in completing this form, call 1-800-PTO-9199 and selection option 2.

<b>Issue Classification</b> 	Application/Control No.	Applicant(s)/Patent under Reexamination	
	10/733,853	NIELSON ET AL.	
	Examiner	Art Unit	
	Jason M. Han	2875	

ISSUE CLASSIFICATION											
ORIGINAL					CROSS REFERENCE(S)						
CLASS		SUBCLASS			CLASS	SUBCLASS (ONE SUBCLASS PER BLOCK)					
362		20			362	228	251				
INTERNATIONAL CLASSIFICATION											
F	2	1	V	23/04							
				/							
				/							
				/							
				/							
Jason Han 1/13/2006 (Assistant Examiner) (Date)					<b>ALAN CARIASO</b> <b>PRIMARY EXAMINER</b> (Primary Examiner) (Date) 1/21/2006					Total Claims Allowed: 32	
<i>Comabola</i> 1/23/06 (Legal Instruments Examiner) (Date)										O.G. Print Claim(s): 1	

<input checked="" type="checkbox"/> Claims renumbered in the same order as presented by applicant										<input type="checkbox"/> CPA		<input type="checkbox"/> T.D.		<input type="checkbox"/> R.1.47	
Final	Original	Final	Original	Final	Original	Final	Original	Final	Original	Final	Original	Final	Original	Final	Original
	1		31		61		91		121		151		181		211
	2		32		62		92		122		152		182		212
	3		33		63		93		123		153		183		213
	4		34		64		94		124		154		184		214
	5		35		65		95		125		155		185		215
	6		36		66		96		126		156		186		216
	7		37		67		97		127		157		187		217
	8		38		68		98		128		158		188		218
	9		39		69		99		129		159		189		219
	10		40		70		100		130		160		190		220
	11		41		71		101		131		161		191		221
	12		42		72		102		132		162		192		222
	13		43		73		103		133		163		193		223
	14		44		74		104		134		164		194		224
	15		45		75		105		135		165		195		225
	16		46		76		106		136		166		196		226
	17		47		77		107		137		167		197		227
	18		48		78		108		138		168		198		228
	19		49		79		109		139		169		199		229
	20		50		80		110		140		170		200		230
	21		51		81		111		141		171		201		231
	22		52		82		112		142		172		202		232
	23		53		83		113		143		173		203		233
	24		54		84		114		144		174		204		234
	25		55		85		115		145		175		205		235
	26		56		86		116		146		176		206		236
	27		57		87		117		147		177		207		237
	28		58		88		118		148		178		208		238
	29		59		89		119		149		179		209		239
	30		60		90		120		150		180		210		240

**Index of Claims**



Application/Control No.

10/733,853

Examiner

Jason M. Han

Applicant(s)/Patent under Reexamination

NIELSON ET AL.

Art Unit

2875

√	Rejected
=	Allowed

-	(Through numeral) Cancelled
+	Restricted

N	Non-Elected
I	Interference

A	Appeal
O	Objected

Claim		Date									
Final	Original	1/13/06									
1	1	=									
2	2	=									
3	3	=									
4	4	=									
5	5	=									
6	6	=									
7	7	=									
8	8	=									
9	9	=									
10	10	=									
11	11	=									
12	12	=									
13	13	=									
14	14	=									
15	15	=									
16	16	=									
17	17	=									
18	18	=									
19	19	=									
20	20	=									
21	21	=									
22	22	=									
23	23	=									
24	24	=									
25	25	=									
26	26	=									
27	27	=									
28	28	=									
29	29	=									
30	30	=									
31	31	=									
32	32	=									
	33										
	34										
	35										
	36										
	37										
	38										
	39										
	40										
	41										
	42										
	43										
	44										
	45										
	46										
	47										
	48										
	49										
	50										

Claim		Date									
Final	Original										
	51										
	52										
	53										
	54										
	55										
	56										
	57										
	58										
	59										
	60										
	61										
	62										
	63										
	64										
	65										
	66										
	67										
	68										
	69										
	70										
	71										
	72										
	73										
	74										
	75										
	76										
	77										
	78										
	79										
	80										
	81										
	82										
	83										
	84										
	85										
	86										
	87										
	88										
	89										
	90										
	91										
	92										
	93										
	94										
	95										
	96										
	97										
	98										
	99										
	100										

Claim		Date									
Final	Original										
	101										
	102										
	103										
	104										
	105										
	106										
	107										
	108										
	109										
	110										
	111										
	112										
	113										
	114										
	115										
	116										
	117										
	118										
	119										
	120										
	121										
	122										
	123										
	124										
	125										
	126										
	127										
	128										
	129										
	130										
	131										
	132										
	133										
	134										
	135										
	136										
	137										
	138										
	139										
	140										
	141										
	142										
	143										
	144										
	145										
	146										
	147										
	148										
	149										
	150										

**Search Notes**



Application/Control No.

10/733,853

Examiner

Jason M. Han

Applicant(s)/Patent under Reexamination

NIELSON ET AL.

Art Unit

2875

**SEARCHED**

Class	Subclass	Date	Examiner
362	20	1/13/2006	JMH
362	228	1/13/2006	JMH
362	240	1/13/2006	JMH
362	249	1/13/2006	JMH
362	251	1/13/2006	JMH
362	800	1/13/2006	JMH

**SEARCH NOTES  
(INCLUDING SEARCH STRATEGY)**

	DATE	EXMR
Search Update - EAST (US-PGPUB, USPAT, USOCR, EPO, JPO, DERWENT) - See Printout	1/13/2006	JMH
P.E. Alan Cariaso	1/13/2006	JMH
STIC Search - Michael Obinna	4/13/2005	JMH
Inventor Search	1/13/2006	JMH

**INTERFERENCE SEARCHED**

Class	Subclass	Date	Examiner
EAST (US-PGPUB) - See Interference Printout		1/13/2006	JMH

**PART B - FEE(S) TRANSMITTAL**

Complete and send this form, together with applicable fee(s), to: Mail

**Mail Stop Issue Fee  
Commissioner for Patents  
P.O. Box 1450  
Alexandria, Virginia 22313-1450  
(571) 273-2885**

or Fax

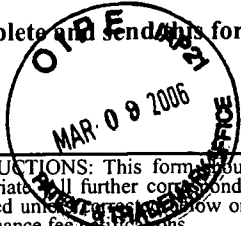

**INSTRUCTIONS:** This form should be used for transmitting the ISSUE FEE and PUBLICATION FEE (if required). Blocks 1 through 5 should be completed where appropriate. All further correspondence including the Patent, advance orders and notification of maintenance fees will be mailed to the current correspondence address as indicated under "Current Correspondence Address" or directed otherwise in Block 1, by (a) specifying a new correspondence address; and/or (b) indicating a separate "FEE ADDRESS" for maintenance fee notifications.

CURRENT CORRESPONDENCE ADDRESS (Note: Use Block 1 for any change of address)

21552 7590 01/25/2006

**MADSON & AUSTIN  
GATEWAY TOWER WEST  
SUITE 900  
15 WEST SOUTH TEMPLE  
SALT LAKE CITY, UT 84101**

Note: A certificate of mailing can only be used for domestic mailings of the Fee(s) Transmittal. This certificate cannot be used for any other accompanying papers. Each additional paper, such as an assignment or formal drawing, must have its own certificate of mailing or transmission.

**Certificate of Mailing or Transmission**

I hereby certify that this Fee(s) Transmittal is being deposited with the United States Postal Service with sufficient postage for first class mail in an envelope addressed to the Mail Stop ISSUE FEE address above, or being facsimile transmitted to the USPTO (571) 273-2885, on the date indicated below.

Craig J. Madson	(Depositor's name)
<i>Craig J. Madson</i>	(Signature)
March 7, 2006	(Date)

APPLICATION NO.	FILING DATE	FIRST NAMED INVENTOR	ATTORNEY DOCKET NO.	CONFIRMATION NO.
10/733,853	12/11/2003	Lyman O. Nielson	3358.2.1	9007

TITLE OF INVENTION: **LOW-VOLTAGE LIGHTING APPARATUS FOR SATISFYING AFTER-HOURS LIGHTING REQUIREMENTS, EMERGENCY LIGHTING REQUIREMENTS, AND LOW LIGHT REQUIREMENTS**

APPLN. TYPE	SMALL ENTITY	ISSUE FEE	PUBLICATION FEE	TOTAL FEE(S) DUE	DATE DUE
nonprovisional	YES	\$700	\$300	\$1000	04/25/2006

EXAMINER	ART UNIT	CLASS-SUBCLASS
HAN, JASON	2875	362-020000

1. Change of correspondence address or indication of "Fee Address" (37 CFR 1.363).  
 Change of correspondence address (or Change of Correspondence Address form PTO/SB/122) attached.  
 "Fee Address" indication (or "Fee Address" Indication form PTO/SB/47; Rev 03-02 or more recent) attached. **Use of a Customer Number is required.**

2. For printing on the patent front page, list  
 (1) the names of up to 3 registered patent attorneys or agents OR, alternatively, 1 MADSON & AUSTIN  
 (2) the name of a single firm (having as a member a registered attorney or agent) and the names of up to 2 registered patent attorneys or agents. If no name is listed, no name will be printed. 2  
3

3. ASSIGNEE NAME AND RESIDENCE DATA TO BE PRINTED ON THE PATENT (print or type)  
 PLEASE NOTE: Unless an assignee is identified below, no assignee data will appear on the patent. If an assignee is identified below, the document has been filed for recordation as set forth in 37 CFR 3.11. Completion of this form is NOT a substitute for filing an assignment.

(A) NAME OF ASSIGNEE: **SAFEexit, Inc.**  
 (B) RESIDENCE: (CITY and STATE OR COUNTRY) **Fruit Heights, Utah**  
 03/10/2006 EAYALEW2 00000083 10733853  
 01 FC:2501 700.00 OP  
 02 FC:1504 300.00 OP  
 03 FC:8001 30.00 OP

Please check the appropriate assignee category or categories (will not be printed on the patent):  Individual  Corporation or other private group entity  Government

4a. The following fee(s) are enclosed:  
 Issue Fee  
 Publication Fee (No small entity discount permitted)  
 Advance Order - # of Copies 10

4b. Payment of Fee(s):  
 A check in the amount of the fee(s) is enclosed.  
 Payment by credit card. Form PTO-2038 is attached.  
 The Director is hereby authorized by charge the required fee(s), or credit any overpayment, to Deposit Account Number 13-0763 (enclose an extra copy of this form).

5. Change in Entity Status (from status indicated above)  
 a. Applicant claims SMALL ENTITY status. See 37 CFR 1.27.  b. Applicant is no longer claiming SMALL ENTITY status. See 37 CFR 1.27(g)(2).

The Director of the USPTO is requested to apply the Issue Fee and Publication Fee (if any) or to re-apply any previously paid issue fee to the application identified above. NOTE: The Issue Fee and Publication Fee (if required) will not be accepted from anyone other than the applicant; a registered attorney or agent; or the assignee or other party in interest as shown by the records of the United States Patent and Trademark Office.

Authorized Signature: *Craig J. Madson* Date: March 7, 2006  
 Typed or printed name: Craig J. Madson Registration No. 29,407

This collection of information is required by 37 CFR 1.311. The information is required to obtain or retain a benefit by the public which is to file (and by the USPTO to process) an application. Confidentiality is governed by 35 U.S.C. 122 and 37 CFR 1.14. This collection is estimated to take 12 minutes to complete, including gathering, preparing, and submitting the completed application form to the USPTO. Time will vary depending upon the individual case. Any comments on the amount of time you require to complete this form and/or suggestions for reducing this burden, should be sent to the Chief Information Officer, U.S. Patent and Trademark Office, U.S. Department of Commerce, P.O. Box 1450, Alexandria, Virginia 22313-1450. DO NOT SEND FEES OR COMPLETED FORMS TO THIS ADDRESS. SEND TO: Commissioner for Patents, P.O. Box 1450, Alexandria, Virginia 22313-1450.

Under the Paperwork Reduction Act of 1995, no persons are required to respond to a collection of information unless it displays a valid OMB control number.

Copied from 10722853 on 04/03/2006

## Electronic Acknowledgement Receipt

<b>EFS ID:</b>	4495923
<b>Application Number:</b>	10733853
<b>International Application Number:</b>	
<b>Confirmation Number:</b>	9007
<b>Title of Invention:</b>	LOW-VOLTAGE LIGHTING APPARATUS FOR SATISFYING AFTER-HOURS LIGHTING REQUIREMENTS, EMERGENCY LIGHTING REQUIREMENTS, AND LOW LIGHT REQUIREMENTS
<b>First Named Inventor/Applicant Name:</b>	Lyman O. Nielson
<b>Customer Number:</b>	21552
<b>Filer:</b>	Craig J. Madson
<b>Filer Authorized By:</b>	
<b>Attorney Docket Number:</b>	3358.2.1
<b>Receipt Date:</b>	19-DEC-2008
<b>Filing Date:</b>	11-DEC-2003
<b>Time Stamp:</b>	17:50:45
<b>Application Type:</b>	Utility under 35 USC 111(a)

### Payment information:

Submitted with Payment	no
------------------------	----

### File Listing:

Document Number	Document Description	File Name	File Size(Bytes)/ Message Digest	Multi Part /.zip	Pages (if appl.)
1	Power of Attorney	3358_2_1_NewPOA.pdf	482945 <small>3947486516c6d8004e7e287ccd31dce2164ee408</small>	no	1

### Warnings:

### Information:

2	Assignee showing of ownership per 37 CFR 3.73(b).	3358_2_1_Stmt37CFR.pdf	476389 <small>11fc0b15e129adb74b52b1d2d8aa211502581f0</small>	no	1
---	---	------------------------	--	----	---

**Warnings:**

**Information:**

<b>Total Files Size (in bytes):</b>	959334
-------------------------------------	--------

**This Acknowledgement Receipt evidences receipt on the noted date by the USPTO of the indicated documents, characterized by the applicant, and including page counts, where applicable. It serves as evidence of receipt similar to a Post Card, as described in MPEP 503.**

**New Applications Under 35 U.S.C. 111**

**If a new application is being filed and the application includes the necessary components for a filing date (see 37 CFR 1.53(b)-(d) and MPEP 506), a Filing Receipt (37 CFR 1.54) will be issued in due course and the date shown on this Acknowledgement Receipt will establish the filing date of the application.**

**National Stage of an International Application under 35 U.S.C. 371**

**If a timely submission to enter the national stage of an international application is compliant with the conditions of 35 U.S.C. 371 and other applicable requirements a Form PCT/DO/EO/903 indicating acceptance of the application as a national stage submission under 35 U.S.C. 371 will be issued in addition to the Filing Receipt, in due course.**

**New International Application Filed with the USPTO as a Receiving Office**

**If a new international application is being filed and the international application includes the necessary components for an international filing date (see PCT Article 11 and MPEP 1810), a Notification of the International Application Number and of the International Filing Date (Form PCT/RO/105) will be issued in due course, subject to prescriptions concerning national security, and the date shown on this Acknowledgement Receipt will establish the international filing date of the application.**



Under the Paperwork Reduction Act of 1995, no persons are required to respond to a collection of information unless it displays a valid OMB control number.

**POWER OF ATTORNEY  
OR  
REVOCAION OF POWER OF ATTORNEY  
WITH A NEW POWER OF ATTORNEY  
AND  
CHANGE OF CORRESPONDENCE ADDRESS**

Application Number	10/733,853
Filing Date	12/11/2003
First Named Inventor	Lyman O. Nielson
Title	LOW-VOLTAGE LIGHTING APPARATUS FOR SATISFYING A
Art Unit	2875
Examiner Name	Jason M. Han
Attorney Docket Number	3358.2.1

I hereby revoke all previous powers of attorney given in the above-identified application.

A Power of Attorney is submitted herewith.

OR

I hereby appoint Practitioner(s) associated with the following Customer Number as my/our attorney(s) or agent(s) to prosecute the application identified above, and to transact all business in the United States Patent and Trademark Office connected therewith:

84138

OR

I hereby appoint Practitioner(s) named below as my/our attorney(s) or agent(s) to prosecute the application identified above, and to transact all business in the United States Patent and Trademark Office connected therewith:

Practitioner(s) Name	Registration Number

Please recognize or change the correspondence address for the above-identified application to:

The address associated with the above-mentioned Customer Number.

OR

The address associated with Customer Number:

OR

Firm or Individual Name

Address

City

State

Zip

Country

Telephone

Email

I am the:

Applicant/Inventor.

OR

Assignee of record of the entire interest. See 37 CFR 3.71.  
Statement under 37 CFR 3.73(b) (Form PTO/SB/96) submitted herewith or filed on \_\_\_\_\_

**SIGNATURE of Applicant or Assignee of Record**

Signature

Date

Name

Norman B. Hess

Telephone

801 441-1823

Title and Company

President, SURETEC Energy Innovations, Inc. (fka SAFEExits, Inc.)

**NOTE:** Signatures of all the inventors or assignees of record of the entire interest or their representative(s) are required. Submit multiple forms if more than one signature is required, see below\*.

\*Total of 2 forms are submitted.

This collection of information is required by 37 CFR 1.31, 1.32 and 1.33. The information is required to obtain or retain a benefit by the public which is to file (and by the USPTO to process) an application. Confidentiality is governed by 35 U.S.C. 122 and 37 CFR 1.11 and 1.14. This collection is estimated to take 3 minutes to complete, including gathering, preparing, and submitting the completed application form to the USPTO. Time will vary depending upon the individual case. Any comments on the amount of time you require to complete this form and/or suggestions for reducing this burden, should be sent to the Chief Information Officer, U.S. Patent and Trademark Office, U.S. Department of Commerce, P.O. Box 1450, Alexandria, VA 22313-1450. DO NOT SEND FEES OR COMPLETED FORMS TO THIS ADDRESS. SEND TO: Commissioner for Patents, P.O. Box 1450, Alexandria, VA 22313-1450.

If you need assistance in completing the form, call 1-800-PTO-9199 and select option 2.

Under the Paperwork Reduction Act of 1995, no persons are required to respond to a collection of information unless it displays a valid OMB control number.

**STATEMENT UNDER 37 CFR 3.73(b)**

Applicant/Patent Owner: SURETEC Energy Innovations, Inc. (fka SAFEexits, Inc.)

Application No./Patent No.: 7,086,747 Filed/Issue Date: 08/08/2006

Entitled: LOW-VOLTAGE LIGHTING APPARATUS FOR SATISFYING AFTER-HOURS LIGHTING REQUIREMENTS, EMERGENCY LIGHTING REQUIREMENTS, AND LOW LIGHT REQUIREMENTS

SAFEexits, Inc. \_\_\_\_\_, a corporation  
(Name of Assignee) (Type of Assignee, e.g., corporation, partnership, university, government agency, etc.)

states that it is:

- 1.  the assignee of the entire right, title, and interest; or
- 2.  an assignee of less than the entire right, title and interest  
(The extent (by percentage) of its ownership interest is \_\_\_\_\_ %)

in the patent application/patent identified above by virtue of either:

A.  An assignment from the inventor(s) of the patent application/patent identified above. The assignment was recorded in the United States Patent and Trademark Office at Reel 015192, Frame 0966, or for which a copy therefore is attached.

OR

B.  A chain of title from the inventor(s), of the patent application/patent identified above, to the current assignee as follows:

1. From: \_\_\_\_\_ To: \_\_\_\_\_

The document was recorded in the United States Patent and Trademark Office at  
Reel \_\_\_\_\_, Frame \_\_\_\_\_, or for which a copy thereof is attached.

2. From: \_\_\_\_\_ To: \_\_\_\_\_

The document was recorded in the United States Patent and Trademark Office at  
Reel \_\_\_\_\_, Frame \_\_\_\_\_, or for which a copy thereof is attached.

3. From: \_\_\_\_\_ To: \_\_\_\_\_

The document was recorded in the United States Patent and Trademark Office at  
Reel \_\_\_\_\_, Frame \_\_\_\_\_, or for which a copy thereof is attached.

Additional documents in the chain of title are listed on a supplemental sheet.

As required by 37 CFR 3.73(b)(1)(i), the documentary evidence of the chain of title from the original owner to the assignee was, or concurrently is being, submitted for recordation pursuant to 37 CFR 3.11.

[NOTE: A separate copy (i.e., a true copy of the original assignment document(s)) must be submitted to Assignment Division in accordance with 37 CFR Part 3, to record the assignment in the records of the USPTO. See MPEP 302.08]

The undersigned (whose title is supplied below) is authorized to act on behalf of the assignee.

Signature

17 Dec 08

Date

Norman B. Hess

Printed or Typed Name

801 641-1873

Telephone Number

President, SURETEC Energy Innovations, Inc. (fka SAFEexits, Inc.)

Title

This collection of information is required by 37 CFR 3.73(b). The information is required to obtain or retain a benefit by the public which is to file (and by the USPTO to process) an application. Confidentiality is governed by 35 U.S.C. 122 and 37 CFR 1.11 and 1.14. This collection is estimated to take 12 minutes to complete, including gathering, preparing, and submitting the completed application form to the USPTO. Time will vary depending upon the individual case. Any comments on the amount of time you require to complete this form and/or suggestions for reducing this burden, should be sent to the Chief Information Officer, U.S. Patent and Trademark Office, U.S. Department of Commerce, P.O. Box 1450, Alexandria, VA 22313-1450. DO NOT SEND FEES OR COMPLETED FORMS TO THIS ADDRESS. SEND TO: Commissioner for Patents, P.O. Box 1450, Alexandria, VA 22313-1450.

If you need assistance in completing the form, call 1-800-PTO-9199 and select option 2.



UNITED STATES PATENT AND TRADEMARK OFFICE

UNITED STATES DEPARTMENT OF COMMERCE  
United States Patent and Trademark Office  
Address: COMMISSIONER FOR PATENTS  
P.O. Box 1450  
Alexandria, Virginia 22313-1450  
www.uspto.gov

APPLICATION NUMBER	FILING OR 371(C) DATE	FIRST NAMED APPLICANT	ATTY. DOCKET NO./TITLE
10/733,853	12/11/2003	Lyman O. Nielson	3358.2.1

**CONFIRMATION NO. 9007**

**POA ACCEPTANCE LETTER**

84138  
MADSON IP  
Old Shepard Commons, Suite 230  
1466 North Highway 89  
Farmington, UT 84025



Date Mailed: 01/02/2009

**NOTICE OF ACCEPTANCE OF POWER OF ATTORNEY**

This is in response to the Power of Attorney filed 12/19/2008.

The Power of Attorney in this application is accepted. Correspondence in this application will be mailed to the above address as provided by 37 CFR 1.33.

/atesfai/

Office of Data Management, Application Assistance Unit (571) 272-4000, or (571) 272-4200, or 1-888-786-0101



UNITED STATES PATENT AND TRADEMARK OFFICE

UNITED STATES DEPARTMENT OF COMMERCE  
United States Patent and Trademark Office  
Address: COMMISSIONER FOR PATENTS  
P.O. Box 1450  
Alexandria, Virginia 22313-1450  
www.uspto.gov

APPLICATION NUMBER	FILING OR 371(C) DATE	FIRST NAMED APPLICANT	ATTY. DOCKET NO./TITLE
10/733,853	12/11/2003	Lyman O. Nielson	3358.2.1

**CONFIRMATION NO. 9007**

**POWER OF ATTORNEY NOTICE**



21552  
AUSTIN RAPP & HARDMAN  
15 WEST SOUTH TEMPLE  
SUITE 900  
SALT LAKE CITY, UT 84101

Date Mailed: 01/02/2009

**NOTICE REGARDING CHANGE OF POWER OF ATTORNEY**

This is in response to the Power of Attorney filed 12/19/2008.

- The Power of Attorney to you in this application has been revoked by the assignee who has intervened as provided by 37 CFR 3.71. Future correspondence will be mailed to the new address of record(37 CFR 1.33).

/atesfai/

Office of Data Management, Application Assistance Unit (571) 272-4000, or (571) 272-4200, or 1-888-786-0101

AO 120 (Rev. 3/04)

<b>TO: Mail Stop 8</b> <b>Director of the U.S. Patent and Trademark Office</b> <b>P.O. Box 1450</b> <b>Alexandria, VA 22313-1450</b>	<b>REPORT ON THE</b> <b>FILING OR DETERMINATION OF AN</b> <b>ACTION REGARDING A PATENT OR</b> <b>TRADEMARK</b>
---	---

In Compliance with 35 U.S.C. § 290 and/or 15 U.S.C. § 1116 you are hereby advised that a court action has been filed in the U.S. District Court Delaware on the following  Patents or  Trademarks:

DOCKET NO. 15cv53-RGA	DATE FILED 1/20/2015	U.S. DISTRICT COURT DISTRICT OF DELAWARE
PLAINTIFF Blackbird Tech LLC		DEFENDANT Service Lighting and Electrical Supplies, Inc., et al.
PATENT OR TRADEMARK NO.	DATE OF PATENT OR TRADEMARK	HOLDER OF PATENT OR TRADEMARK
1 US 7,086,747 B2	8/8/2006	Blackbird Technologies
2		
3		
4		
5		

In the above—entitled case, the following patent(s)/ trademark(s) have been included:

DATE INCLUDED	INCLUDED BY <input type="checkbox"/> Amendment <input type="checkbox"/> Answer <input type="checkbox"/> Cross Bill <input type="checkbox"/> Other Pleading		
PATENT OR TRADEMARK NO.	DATE OF PATENT OR TRADEMARK	HOLDER OF PATENT OR TRADEMARK	
1			
2			
3			
4			
5			

In the above—entitled case, the following decision has been rendered or judgement issued:

DECISION/JUDGEMENT  See attached Order
--

CLERK JOHN A. CERINO, CLERK OF COURT	(BY) DEPUTY CLERK	DATE 8/17/2016
---	-------------------	-------------------

Copy 1—Upon initiation of action, mail this copy to Director    Copy 3—Upon termination of action, mail this copy to Director  
 Copy 2—Upon filing document adding patent(s), mail this copy to Director    Copy 4—Case file copy

AO 120 (Rev. 3/04)

<p style="text-align: center;"><b>Mail Stop 8</b>  <b>Director of the U.S. Patent and Trademark Office</b>  <b>P.O. Box 1450</b>  <b>Alexandria, VA 22313-1450</b></p>	<p><b>REPORT ON THE</b>  <b>FILING OR DETERMINATION OF AN</b>  <b>ACTION REGARDING A PATENT OR</b>  <b>TRADEMARK</b></p>
--	--

In Compliance with 35 U.S.C. § 290 and/or 15 U.S.C. § 1116 you are hereby advised that a court action has been filed in the U.S. District Court Delaware on the following  Patents or  Trademarks:

DOCKET NO. 15cv61-RGA	DATE FILED 1/20/2015	U.S. DISTRICT COURT DISTRICT OF DELAWARE
PLAINTIFF Blackbird Tech LLC		DEFENDANT Home Ever, Inc.
PATENT OR TRADEMARK NO.	DATE OF PATENT OR TRADEMARK	HOLDER OF PATENT OR TRADEMARK
1	US 7,086,747 B2 8/8/2006	Blackbird Technologies
2		
3		
4		
5		

In the above—entitled case, the following patent(s)/ trademark(s) have been included:

DATE INCLUDED	INCLUDED BY <input type="checkbox"/> Amendment <input type="checkbox"/> Answer <input type="checkbox"/> Cross Bill <input type="checkbox"/> Other Pleading		
PATENT OR TRADEMARK NO.	DATE OF PATENT OR TRADEMARK	HOLDER OF PATENT OR TRADEMARK	
1			
2			
3			
4			
5			

In the above—entitled case, the following decision has been rendered or judgement issued:

<p>DECISION/JUDGEMENT</p> <p>See attached Order</p>
---

<p>CLERK JOHN A. CERINO, CLERK OF COURT</p>	<p>(BY) DEPUTY CLERK</p>	<p>DATE 8/17/2016</p>
---	--------------------------	---------------------------

Copy 1—Upon initiation of action, mail this copy to Director    Copy 3—Upon termination of action, mail this copy to Director  
 Copy 2—Upon filing document adding patent(s), mail this copy to Director    Copy 4—Case file copy

AO 120 (Rev. 08/10)

<b>TO: Mail Stop 8</b> <b>Director of the U.S. Patent and Trademark Office</b> <b>P.O. Box 1450</b> <b>Alexandria, VA 22313-1450</b>	<b>REPORT ON THE</b> <b>FILING OR DETERMINATION OF AN</b> <b>ACTION REGARDING A PATENT OR</b> <b>TRADEMARK</b>
---	---

In Compliance with 35 U.S.C. § 290 and/or 15 U.S.C. § 1116 you are hereby advised that a court action has been filed in the U.S. District Court \_\_\_\_\_ for the District of Delaware \_\_\_\_\_ on the following

Trademarks or  Patents. (  the patent action involves 35 U.S.C. § 292.):

DOCKET NO.	DATE FILED 10/19/2016	U.S. DISTRICT COURT for the District of Delaware
PLAINTIFF BLACKBIRD TECH LLC d/b/a BLACKBIRD TECHNOLOGIES		DEFENDANT HYPERIKON, INC.
PATENT OR TRADEMARK NO.	DATE OF PATENT OR TRADEMARK	HOLDER OF PATENT OR TRADEMARK
1 US 7,086,747 B2	8/8/2006	Blackbird Technologies
2		
3		
4		
5		

In the above—entitled case, the following patent(s)/ trademark(s) have been included:

DATE INCLUDED	INCLUDED BY <input type="checkbox"/> Amendment <input type="checkbox"/> Answer <input type="checkbox"/> Cross Bill <input type="checkbox"/> Other Pleading	
PATENT OR TRADEMARK NO.	DATE OF PATENT OR TRADEMARK	HOLDER OF PATENT OR TRADEMARK
1		
2		
3		
4		
5		

In the above—entitled case, the following decision has been rendered or judgement issued:

DECISION/JUDGEMENT
--------------------

CLERK	(BY) DEPUTY CLERK	DATE
-------	-------------------	------

Copy 1—Upon initiation of action, mail this copy to Director Copy 3—Upon termination of action, mail this copy to Director  
 Copy 2—Upon filing document adding patent(s), mail this copy to Director Copy 4—Case file copy

AO 120 (Rev. 08/10)

<b>TO: Mail Stop 8 Director of the U.S. Patent and Trademark Office P.O. Box 1450 Alexandria, VA 22313-1450</b>	<b>REPORT ON THE FILING OR DETERMINATION OF AN ACTION REGARDING A PATENT OR TRADEMARK</b>
---	---

In Compliance with 35 U.S.C. § 290 and/or 15 U.S.C. § 1116 you are hereby advised that a court action has been filed in the U.S. District Court \_\_\_\_\_ for the District of Delaware \_\_\_\_\_ on the following

Trademarks or  Patents. (  the patent action involves 35 U.S.C. § 292.):

DOCKET NO.	DATE FILED 10/19/2016	U.S. DISTRICT COURT for the District of Delaware
PLAINTIFF BLACKBIRD TECH LLC d/b/a BLACKBIRD TECHNOLOGIES		DEFENDANT EIKO GLOBAL, LLC
PATENT OR TRADEMARK NO.	DATE OF PATENT OR TRADEMARK	HOLDER OF PATENT OR TRADEMARK
1 US 7,086,747 B2	8/8/2006	Blackbird Technologies
2		
3		
4		
5		

In the above—entitled case, the following patent(s)/ trademark(s) have been included:

DATE INCLUDED	INCLUDED BY <input type="checkbox"/> Amendment <input type="checkbox"/> Answer <input type="checkbox"/> Cross Bill <input type="checkbox"/> Other Pleading	
PATENT OR TRADEMARK NO.	DATE OF PATENT OR TRADEMARK	HOLDER OF PATENT OR TRADEMARK
1		
2		
3		
4		
5		

In the above—entitled case, the following decision has been rendered or judgement issued:

DECISION/JUDGEMENT
--------------------

CLERK	(BY) DEPUTY CLERK	DATE
-------	-------------------	------

Copy 1—Upon initiation of action, mail this copy to Director Copy 3—Upon termination of action, mail this copy to Director  
Copy 2—Upon filing document adding patent(s), mail this copy to Director Copy 4—Case file copy



AO 120 (Rev. 08/10)

<b>TO: Mail Stop 8 Director of the U.S. Patent and Trademark Office P.O. Box 1450 Alexandria, VA 22313-1450</b>	<b>REPORT ON THE FILING OR DETERMINATION OF AN ACTION REGARDING A PATENT OR TRADEMARK</b>
---	---

In Compliance with 35 U.S.C. § 290 and/or 15 U.S.C. § 1116 you are hereby advised that a court action has been filed in the U.S. District Court \_\_\_\_\_ for the District of Delaware \_\_\_\_\_ on the following

Trademarks or  Patents. (  the patent action involves 35 U.S.C. § 292.):

DOCKET NO.	DATE FILED 10/19/2016	U.S. DISTRICT COURT for the District of Delaware
PLAINTIFF BLACKBIRD TECH LLC d/b/a BLACKBIRD TECHNOLOGIES		DEFENDANT REMPHOS TECHNOLOGIES LLC
PATENT OR TRADEMARK NO.	DATE OF PATENT OR TRADEMARK	HOLDER OF PATENT OR TRADEMARK
1 US 7,086,747 B2	8/8/2006	Blackbird Technologies
2		
3		
4		
5		

In the above—entitled case, the following patent(s)/ trademark(s) have been included:

DATE INCLUDED	INCLUDED BY <input type="checkbox"/> Amendment <input type="checkbox"/> Answer <input type="checkbox"/> Cross Bill <input type="checkbox"/> Other Pleading	
PATENT OR TRADEMARK NO.	DATE OF PATENT OR TRADEMARK	HOLDER OF PATENT OR TRADEMARK
1		
2		
3		
4		
5		

In the above—entitled case, the following decision has been rendered or judgement issued:

DECISION/JUDGEMENT
--------------------

CLERK	(BY) DEPUTY CLERK	DATE
-------	-------------------	------

Copy 1—Upon initiation of action, mail this copy to Director Copy 3—Upon termination of action, mail this copy to Director  
Copy 2—Upon filing document adding patent(s), mail this copy to Director Copy 4—Case file copy

AO 120 (Rev. 08/10)

<b>TO: Mail Stop 8</b> <b>Director of the U.S. Patent and Trademark Office</b> <b>P.O. Box 1450</b> <b>Alexandria, VA 22313-1450</b>	<b>REPORT ON THE</b> <b>FILING OR DETERMINATION OF AN</b> <b>ACTION REGARDING A PATENT OR</b> <b>TRADEMARK</b>
---	---

In Compliance with 35 U.S.C. § 290 and/or 15 U.S.C. § 1116 you are hereby advised that a court action has been filed in the U.S. District Court \_\_\_\_\_ for the District of Delaware \_\_\_\_\_ on the following

Trademarks or  Patents. (  the patent action involves 35 U.S.C. § 292.):

DOCKET NO.	DATE FILED 10/19/2016	U.S. DISTRICT COURT for the District of Delaware
PLAINTIFF BLACKBIRD TECH LLC d/b/a BLACKBIRD TECHNOLOGIES		DEFENDANT DAMAR WORLDWIDE 4 LLC
PATENT OR TRADEMARK NO.	DATE OF PATENT OR TRADEMARK	HOLDER OF PATENT OR TRADEMARK
1 US 7,086,747 B2	8/8/2006	Blackbird Technologies
2		
3		
4		
5		

In the above—entitled case, the following patent(s)/ trademark(s) have been included:

DATE INCLUDED	INCLUDED BY <input type="checkbox"/> Amendment <input type="checkbox"/> Answer <input type="checkbox"/> Cross Bill <input type="checkbox"/> Other Pleading	
PATENT OR TRADEMARK NO.	DATE OF PATENT OR TRADEMARK	HOLDER OF PATENT OR TRADEMARK
1		
2		
3		
4		
5		

In the above—entitled case, the following decision has been rendered or judgement issued:

DECISION/JUDGEMENT
--------------------

CLERK	(BY) DEPUTY CLERK	DATE
-------	-------------------	------

Copy 1—Upon initiation of action, mail this copy to Director Copy 3—Upon termination of action, mail this copy to Director  
 Copy 2—Upon filing document adding patent(s), mail this copy to Director Copy 4—Case file copy

AO 120 (Rev. 3/04)

<b>TO: Mail Stop 8</b> <b>Director of the U.S. Patent and Trademark Office</b> <b>P.O. Box 1450</b> <b>Alexandria, VA 22313-1450</b>	<b>REPORT ON THE</b> <b>FILING OR DETERMINATION OF AN</b> <b>ACTION REGARDING A PATENT OR</b> <b>TRADEMARK</b>
---	---

In Compliance with 35 U.S.C. § 290 and/or 15 U.S.C. § 1116 you are hereby advised that a court action has been filed in the U.S. District Court Delaware on the following  Patents or  Trademarks:

DOCKET NO. 15cv64-RGA	DATE FILED 1/20/2015	U.S. DISTRICT COURT DISTRICT OF DELAWARE
PLAINTIFF Blackbird Tech LLC d/b/a Blackbird Technologies		DEFENDANT Kobi Electric, Inc.
PATENT OR TRADEMARK NO.	DATE OF PATENT OR TRADEMARK	HOLDER OF PATENT OR TRADEMARK
1 US 7,086,747 B2	8/8/2006	Blackbird Technologies
2		
3		
4		
5		

In the above—entitled case, the following patent(s)/ trademark(s) have been included:

DATE INCLUDED	INCLUDED BY <input type="checkbox"/> Amendment <input type="checkbox"/> Answer <input type="checkbox"/> Cross Bill <input type="checkbox"/> Other Pleading		
PATENT OR TRADEMARK NO.	DATE OF PATENT OR TRADEMARK	HOLDER OF PATENT OR TRADEMARK	
1			
2			
3			
4			
5			

In the above—entitled case, the following decision has been rendered or judgement issued:

DECISION/JUDGEMENT  See attached Order
--

CLERK JOHN A. CERINO, CLERK OF COURT	(BY) DEPUTY CLERK	DATE 10/28/2016
---	-------------------	--------------------

Copy 1—Upon initiation of action, mail this copy to Director    Copy 3—Upon termination of action, mail this copy to Director  
 Copy 2—Upon filing document adding patent(s), mail this copy to Director    Copy 4—Case file copy