



UNITED STATES PATENT AND TRADEMARK OFFICE

UNITED STATES DEPARTMENT OF COMMERCE
United States Patent and Trademark Office
Address: COMMISSIONER FOR PATENTS
P.O. Box 1450
Alexandria, Virginia 22313-1450
www.uspto.gov

Table with 5 columns: APPLICATION NO., ISSUE DATE, PATENT NO., ATTORNEY DOCKET NO., CONFIRMATION NO.
Row 1: 11/502,921, 08/30/2011, 8009573, 11005.0219-00000, 9151

97664 7590 08/10/2011
Huawei Technologies Co., Ltd./Finnegan
901 New York Avenue
NW
Washington, DC 20001

ISSUE NOTIFICATION

The projected patent number and issue date are specified above.

Determination of Patent Term Adjustment under 35 U.S.C. 154 (b)
(application filed on or after May 29, 2000)

The Patent Term Adjustment is 1419 day(s). Any patent to issue from the above-identified application will include an indication of the adjustment on the front page.

If a Continued Prosecution Application (CPA) was filed in the above-identified application, the filing date that determines Patent Term Adjustment is the filing date of the most recent CPA.

Applicant will be able to obtain more detailed information by accessing the Patent Application Information Retrieval (PAIR) WEB site (http://pair.uspto.gov).

Any questions regarding the Patent Term Extension or Adjustment determination should be directed to the Office of Patent Legal Administration at (571)-272-7702. Questions relating to issue and publication fee payments should be directed to the Application Assistance Unit (AAU) of the Office of Data Management (ODM) at (571)-272-4200.

APPLICANT(s) (Please see PAIR WEB site http://pair.uspto.gov for additional applicants):

Xiaoqin Duan, Shenzhen, CHINA;

PART B - FEE(S) TRANSMITTAL

Complete and send this form, together with applicable fee(s), to: **Mail** **Mail Stop ISSUE FEE**
Commissioner for Patents
P.O. Box 1450
Alexandria, Virginia 22313-1450
 or **Fax** **(571)-273-2885**

INSTRUCTIONS: This form should be used for transmitting the ISSUE FEE and PUBLICATION FEE (if required). Blocks 1 through 5 should be completed where appropriate. All further correspondence including the Patent, advance orders and notification of maintenance fees will be mailed to the current correspondence address as indicated unless corrected below or directed otherwise in Block 1, by (a) specifying a new correspondence address; and/or (b) indicating a separate "FEE ADDRESS" for maintenance fee notifications.

CURRENT CORRESPONDENCE ADDRESS (Note: Use Block 1 for any change of address)

97664 7590 04/27/2011
Huawei Technologies Co., Ltd./Finnegan
 901 New York Avenue
 NW
 Washington, DC 20001

Note: A certificate of mailing can only be used for domestic mailings of the Fee(s) Transmittal. This certificate cannot be used for any other accompanying papers. Each additional paper, such as an assignment or formal drawing, must have its own certificate of mailing or transmission.

Certificate of Mailing or Transmission

I hereby certify that this Fee(s) Transmittal is being deposited with the United States Postal Service with sufficient postage for first class mail in an envelope addressed to the Mail Stop ISSUE FEE address above, or being facsimile transmitted to the USPTO (571) 273-2885, on the date indicated below.

(Depositor's name:)
(Signature:)
(Date:)

APPLICATION NO.	FILING DATE	FIRST NAMED INVENTOR	ATTORNEY DOCKET NO.	CONFIRMATION NO.
-----------------	-------------	----------------------	---------------------	------------------

11/502,921	08/11/2006	Xiaoqin Duan	11005.0219-00000	9151
------------	------------	--------------	------------------	------

TITLE OF INVENTION: METHOD FOR CONTROLLING CHARGING OF PACKET DATA SERVICE

APPLN. TYPE	SMALL ENTITY	ISSUE FEE DUE	PUBLICATION FEE DUE	PREV. PAID ISSUE FEE	TOTAL FEE(S) DUE	DATE DUE
-------------	--------------	---------------	---------------------	----------------------	------------------	----------

nonprovisional	NO	\$1510	\$300	\$0	\$1810	07/27/2011
----------------	----	--------	-------	-----	--------	------------

EXAMINER	ART UNIT	CLASS-SUBCLASS
----------	----------	----------------

TIEU, BINH KIEN	2614	379-114010
-----------------	------	------------

1. Change of correspondence address or indication of "Fee Address" (37 CFR 1.363).

- Change of correspondence address (or Change of Correspondence Address form PTO/SB/122) attached.
- "Fee Address" indication (or "Fee Address" Indication form PTO/SB/47; Rev 03-02 or more recent) attached. Use of a Customer Number is required.

2. For printing on the patent front page, list

- (1) the names of up to 3 registered patent attorneys or agents OR, alternatively,
- (2) the name of a single firm (having as a member a registered attorney or agent) and the names of up to 2 registered patent attorneys or agents. If no name is listed, no name will be printed.

1 Finnegan, Henderson,
 2 Farabow, Garrett, &
 3 Dunner LLP

3. ASSIGNEE NAME AND RESIDENCE DATA TO BE PRINTED ON THE PATENT (print or type)

PLEASE NOTE: Unless an assignee is identified below, no assignee data will appear on the patent. If an assignee is identified below, the document has been filed for recordation as set forth in 37 CFR 3.11. Completion of this form is NOT a substitute for filing an assignment.

(A) NAME OF ASSIGNEE (B) RESIDENCE: (CITY and STATE OR COUNTRY)

Huawei Technologies Co., LTD Shenzhen, China

Please check the appropriate assignee category or categories (will not be printed on the patent): Individual Corporation or other private group entity Government

4a. The following fee(s) are submitted:

- Issue Fee
- Publication Fee (No small entity discount permitted)
- Advance Order - # of Copies

4b. Payment of Fee(s): (Please first reapply any previously paid issue fee shown above)

- A check is enclosed.
- Payment by credit card. Form PTO-2038 is attached.
- The Director is hereby authorized to charge the required fee(s), any deficiency, or credit any overpayment, to Deposit Account Number 06-0916 (enclose an extra copy of this form).

5. Change in Entity Status (from status indicated above)

- a. Applicant claims SMALL ENTITY status. See 37 CFR 1.27. b. Applicant is no longer claiming SMALL ENTITY status. See 37 CFR 1.27(g)(2).

NOTE: The Issue Fee and Publication Fee (if required) will not be accepted from anyone other than the applicant; a registered attorney or agent; or the assignee or other party in interest as shown by the records of the United States Patent and Trademark Office.

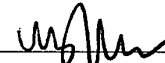
Authorized Signature 
 Typed or printed name Weiguo Chen

Date 7/26/2011
 Registration No. 61,878

This collection of information is required by 37 CFR 1.311. The information is required to obtain or retain a benefit by the public which is to file (and by the USPTO to process) an application. Confidentiality is governed by 35 U.S.C. 122 and 37 CFR 1.14. This collection is estimated to take 12 minutes to complete, including gathering, preparing, and submitting the completed application form to the USPTO. Time will vary depending upon the individual case. Any comments on the amount of time you require to complete this form and/or suggestions for reducing this burden, should be sent to the Chief Information Officer, U.S. Patent and Trademark Office, U.S. Department of Commerce, P.O. Box 1450, Alexandria, Virginia 22313-1450. DO NOT SEND FEES OR COMPLETED FORMS TO THIS ADDRESS. SEND TO: Commissioner for Patents, P.O. Box 1450, Alexandria, Virginia 22313-1450.

Under the Paperwork Reduction Act of 1995, no persons are required to respond to a collection of information unless it displays a valid OMB control number.

"FEE ADDRESS" INDICATION FORM

Address to:
Mail Stop M Correspondence
Commissioner for Patents
P.O. Box 1450
Alexandria, VA 22313-1450

Fax to:
571-273-6500

- OR -

INSTRUCTIONS: The issue fee must have been paid for application(s) listed on this form. In addition, only an address represented by a Customer Number can be established as the fee address for maintenance fee purposes (hereafter, fee address). A fee address should be established when correspondence related to maintenance fees should be mailed to a different address than the correspondence address for the application. **When to check the first box below:** If you have a Customer Number to represent the fee address. **When to check the second box below:** If you have no Customer Number representing the desired fee address, in which case a completed Request for Customer Number (PTO/SB/125) must be attached to this form. For more information on Customer Numbers, see the Manual of Patent Examining Procedure (MPEP) § 403.

For the following listed application(s), please recognize as the "Fee Address" under the provisions of 37 CFR 1.363 the address associated with:

Customer Number: **00197**

OR

The attached Request for Customer Number (PTO/SB/125) form.

PATENT NUMBER (if known)	APPLICATION NUMBER
	11/502,921

Completed by (check one):

Applicant/Inventor

 Signature

Attorney or Agent of record 61,878
 (Reg. No.)

Weiguo Chen
 Typed or printed name

Assignee of record of the entire interest. See 37 CFR 3.71.
 Statement under 37 CFR 3.73(b) is enclosed.
 (Form PTO/SB/96)

650-849-6600
 Requester's telephone number

Assignee recorded at Reel _____ Frame _____

7/26/2011
 Date

NOTE: Signatures of all the inventors or assignees of record of the entire interest or their representative(s) are required. Submit multiple forms if more than one signature is required, see below*.

* Total of _____ forms are submitted.

This collection of information is required by 37 CFR 1.363. The information is required to obtain or retain a benefit by the public which is to file (and by the USPTO to process) an application. Confidentiality is governed by 35 U.S.C. 122 and 37 CFR 1.11 and 1.14. This collection is estimated to take 5 minutes to complete, including gathering, preparing, and submitting the completed application form to the USPTO. Time will vary depending upon the individual case. Any comments on the amount of time you require to complete this form and/or suggestions for reducing this burden, should be sent to the Chief Information Officer, U.S. Patent and Trademark Office, U.S. Department of Commerce, P.O. Box 1450, Alexandria, VA 22313-1450. DO NOT SEND COMPLETE D FORMS TO THIS ADDRESS. SEND TO: Mail Stop M Correspondence, Commissioner for Patents, P.O. Box 1450, Alexandria, VA 22313-1450.

If you need assistance in completing the form, call 1-800-PTO-9199 and select option 2.

Electronic Patent Application Fee Transmittal

Application Number:	11502921			
Filing Date:	11-Aug-2006			
Title of Invention:	METHOD FOR CONTROLLING CHARGING OF PACKET DATA SERVICE			
First Named Inventor/Applicant Name:	Xiaoqin Duan			
Filer:	Weiguo Chen/Nicole Walsh			
Attorney Docket Number:	11005.0219-00000			
Filed as Large Entity				
Utility under 35 USC 111(a) Filing Fees				
Description	Fee Code	Quantity	Amount	Sub-Total in USD(\$)
Basic Filing:				
Pages:				
Claims:				
Miscellaneous-Filing:				
Petition:				
Patent-Appeals-and-Interference:				
Post-Allowance-and-Post-Issuance:				
Utility Appl issue fee	1501	1	1510	1510
Publ. Fee- early, voluntary, or normal	1504	1	300	300

Description	Fee Code	Quantity	Amount	Sub-Total in USD(\$)
Extension-of-Time:				
Miscellaneous:				
Total in USD (\$)				1810

Electronic Acknowledgement Receipt

EFS ID:	10603326
Application Number:	11502921
International Application Number:	
Confirmation Number:	9151
Title of Invention:	METHOD FOR CONTROLLING CHARGING OF PACKET DATA SERVICE
First Named Inventor/Applicant Name:	Xiaoqin Duan
Customer Number:	97664
Filer:	Weiguo Chen/Nicole Walsh
Filer Authorized By:	Weiguo Chen
Attorney Docket Number:	11005.0219-00000
Receipt Date:	26-JUL-2011
Filing Date:	11-AUG-2006
Time Stamp:	19:05:07
Application Type:	Utility under 35 USC 111(a)

Payment information:

Submitted with Payment	yes
Payment Type	Deposit Account
Payment was successfully received in RAM	\$1810
RAM confirmation Number	5469
Deposit Account	060916
Authorized User	

File Listing:

Document Number	Document Description	File Name	File Size(Bytes)/ Message Digest	Multi Part /.zip	Pages (if appl.)
-----------------	----------------------	-----------	-------------------------------------	------------------	------------------

1		0410606USIssueFeePayment.pdf	101139 d5dbfbd2b1227e54d007e68c2044b3197d7b81f1	yes	2
Multipart Description/PDF files in .zip description					
		Document Description	Start	End	
		Issue Fee Payment (PTO-85B)	1	1	
		Change of Address	2	2	
Warnings:					
The page size in the PDF is too large. The pages should be 8.5 x 11 or A4. If this PDF is submitted, the pages will be resized upon entry into the Image File Wrapper and may affect subsequent processing					
Information:					
2	Fee Worksheet (SB06)	fee-info.pdf	32127 5a24c87f42cb81397c4ffe1bb2ee6399f2c5d42	no	2
Warnings:					
Information:					
Total Files Size (in bytes):			133266		
<p>This Acknowledgement Receipt evidences receipt on the noted date by the USPTO of the indicated documents, characterized by the applicant, and including page counts, where applicable. It serves as evidence of receipt similar to a Post Card, as described in MPEP 503.</p> <p><u>New Applications Under 35 U.S.C. 111</u> If a new application is being filed and the application includes the necessary components for a filing date (see 37 CFR 1.53(b)-(d) and MPEP 506), a Filing Receipt (37 CFR 1.54) will be issued in due course and the date shown on this Acknowledgement Receipt will establish the filing date of the application.</p> <p><u>National Stage of an International Application under 35 U.S.C. 371</u> If a timely submission to enter the national stage of an international application is compliant with the conditions of 35 U.S.C. 371 and other applicable requirements a Form PCT/DO/EO/903 indicating acceptance of the application as a national stage submission under 35 U.S.C. 371 will be issued in addition to the Filing Receipt, in due course.</p> <p><u>New International Application Filed with the USPTO as a Receiving Office</u> If a new international application is being filed and the international application includes the necessary components for an international filing date (see PCT Article 11 and MPEP 1810), a Notification of the International Application Number and of the International Filing Date (Form PCT/RO/105) will be issued in due course, subject to prescriptions concerning national security, and the date shown on this Acknowledgement Receipt will establish the international filing date of the application.</p>					



UNITED STATES PATENT AND TRADEMARK OFFICE

UNITED STATES DEPARTMENT OF COMMERCE
United States Patent and Trademark Office
Address: COMMISSIONER FOR PATENTS
P.O. Box 1450
Alexandria, Virginia 22313-1450
www.uspto.gov

NOTICE OF ALLOWANCE AND FEE(S) DUE

97664 7590 04/27/2011
Huawei Technologies Co., Ltd./Finnegan
901 New York Avenue
NW
Washington, DC 20001

EXAMINER
TIEU, BINH KIEN

ART UNIT PAPER NUMBER
2614

DATE MAILED: 04/27/2011

Table with 5 columns: APPLICATION NO., FILING DATE, FIRST NAMED INVENTOR, ATTORNEY DOCKET NO., CONFIRMATION NO.

TITLE OF INVENTION: METHOD FOR CONTROLLING CHARGING OF PACKET DATA SERVICE

Table with 7 columns: APPLN. TYPE, SMALL ENTITY, ISSUE FEE DUE, PUBLICATION FEE DUE, PREV. PAID ISSUE FEE, TOTAL FEE(S) DUE, DATE DUE

THE APPLICATION IDENTIFIED ABOVE HAS BEEN EXAMINED AND IS ALLOWED FOR ISSUANCE AS A PATENT. PROSECUTION ON THE MERITS IS CLOSED. THIS NOTICE OF ALLOWANCE IS NOT A GRANT OF PATENT RIGHTS. THIS APPLICATION IS SUBJECT TO WITHDRAWAL FROM ISSUE AT THE INITIATIVE OF THE OFFICE OR UPON PETITION BY THE APPLICANT. SEE 37 CFR 1.313 AND MPEP 1308.

THE ISSUE FEE AND PUBLICATION FEE (IF REQUIRED) MUST BE PAID WITHIN THREE MONTHS FROM THE MAILING DATE OF THIS NOTICE OR THIS APPLICATION SHALL BE REGARDED AS ABANDONED. THIS STATUTORY PERIOD CANNOT BE EXTENDED. SEE 35 U.S.C. 151. THE ISSUE FEE DUE INDICATED ABOVE DOES NOT REFLECT A CREDIT FOR ANY PREVIOUSLY PAID ISSUE FEE IN THIS APPLICATION. IF AN ISSUE FEE HAS PREVIOUSLY BEEN PAID IN THIS APPLICATION (AS SHOWN ABOVE), THE RETURN OF PART B OF THIS FORM WILL BE CONSIDERED A REQUEST TO REAPPLY THE PREVIOUSLY PAID ISSUE FEE TOWARD THE ISSUE FEE NOW DUE.

HOW TO REPLY TO THIS NOTICE:

I. Review the SMALL ENTITY status shown above.

If the SMALL ENTITY is shown as YES, verify your current SMALL ENTITY status:

- A. If the status is the same, pay the TOTAL FEE(S) DUE shown above.
B. If the status above is to be removed, check box 5b on Part B - Fee(s) Transmittal and pay the PUBLICATION FEE (if required) and twice the amount of the ISSUE FEE shown above, or

If the SMALL ENTITY is shown as NO:

- A. Pay TOTAL FEE(S) DUE shown above, or
B. If applicant claimed SMALL ENTITY status before, or is now claiming SMALL ENTITY status, check box 5a on Part B - Fee(s) Transmittal and pay the PUBLICATION FEE (if required) and 1/2 the ISSUE FEE shown above.

II. PART B - FEE(S) TRANSMITTAL, or its equivalent, must be completed and returned to the United States Patent and Trademark Office (USPTO) with your ISSUE FEE and PUBLICATION FEE (if required). If you are charging the fee(s) to your deposit account, section "4b" of Part B - Fee(s) Transmittal should be completed and an extra copy of the form should be submitted. If an equivalent of Part B is filed, a request to reapply a previously paid issue fee must be clearly made, and delays in processing may occur due to the difficulty in recognizing the paper as an equivalent of Part B.

III. All communications regarding this application must give the application number. Please direct all communications prior to issuance to Mail Stop ISSUE FEE unless advised to the contrary.

IMPORTANT REMINDER: Utility patents issuing on applications filed on or after Dec. 12, 1980 may require payment of maintenance fees. It is patentee's responsibility to ensure timely payment of maintenance fees when due.

PART B - FEE(S) TRANSMITTAL

**Complete and send this form, together with applicable fee(s), to: Mail Mail Stop ISSUE FEE
 Commissioner for Patents
 P.O. Box 1450
 Alexandria, Virginia 22313-1450
 or Fax (571)-273-2885**

INSTRUCTIONS: This form should be used for transmitting the ISSUE FEE and PUBLICATION FEE (if required). Blocks 1 through 5 should be completed where appropriate. All further correspondence including the Patent, advance orders and notification of maintenance fees will be mailed to the current correspondence address as indicated unless corrected below or directed otherwise in Block 1, by (a) specifying a new correspondence address; and/or (b) indicating a separate "FEE ADDRESS" for maintenance fee notifications.

CURRENT CORRESPONDENCE ADDRESS (Note: Use Block 1 for any change of address)

Note: A certificate of mailing can only be used for domestic mailings of the Fee(s) Transmittal. This certificate cannot be used for any other accompanying papers. Each additional paper, such as an assignment or formal drawing, must have its own certificate of mailing or transmission.

97664 7590 04/27/2011
 Huawei Technologies Co., Ltd./Finnegan
 901 New York Avenue
 NW
 Washington, DC 20001

Certificate of Mailing or Transmission
 I hereby certify that this Fee(s) Transmittal is being deposited with the United States Postal Service with sufficient postage for first class mail in an envelope addressed to the Mail Stop ISSUE FEE address above, or being facsimile transmitted to the USPTO (571) 273-2885, on the date indicated below.

_____	(Depositor's name)
_____	(Signature)
_____	(Date)

APPLICATION NO.	FILING DATE	FIRST NAMED INVENTOR	ATTORNEY DOCKET NO.	CONFIRMATION NO.
11/502,921	08/11/2006	Xiaoqin Duan	11005.0219-00000	9151

TITLE OF INVENTION: METHOD FOR CONTROLLING CHARGING OF PACKET DATA SERVICE

APPLN. TYPE	SMALL ENTITY	ISSUE FEE DUE	PUBLICATION FEE DUE	PREV. PAID ISSUE FEE	TOTAL FEE(S) DUE	DATE DUE
nonprovisional	NO	\$1510	\$300	\$0	\$1810	07/27/2011

EXAMINER	ART UNIT	CLASS-SUBCLASS
TIEU, BINH KIEN	2614	379-114010

<p>1. Change of correspondence address or indication of "Fee Address" (37 CFR 1.363).</p> <p><input type="checkbox"/> Change of correspondence address (or Change of Correspondence Address form PTO/SB/122) attached.</p> <p><input type="checkbox"/> "Fee Address" indication (or "Fee Address" Indication form PTO/SB/47; Rev 03-02 or more recent) attached. Use of a Customer Number is required.</p>	<p>2. For printing on the patent front page, list</p> <p>(1) the names of up to 3 registered patent attorneys or agents OR, alternatively, _____ 1</p> <p>(2) the name of a single firm (having as a member a registered attorney or agent) and the names of up to 2 registered patent attorneys or agents. If no name is listed, no name will be printed. _____ 2</p> <p>_____ 3</p>
---	---

3. ASSIGNEE NAME AND RESIDENCE DATA TO BE PRINTED ON THE PATENT (print or type)

PLEASE NOTE: Unless an assignee is identified below, no assignee data will appear on the patent. If an assignee is identified below, the document has been filed for recordation as set forth in 37 CFR 3.11. Completion of this form is NOT a substitute for filing an assignment.

(A) NAME OF ASSIGNEE _____ (B) RESIDENCE: (CITY and STATE OR COUNTRY) _____

Please check the appropriate assignee category or categories (will not be printed on the patent): Individual Corporation or other private group entity Government

<p>4a. The following fee(s) are submitted:</p> <p><input type="checkbox"/> Issue Fee</p> <p><input type="checkbox"/> Publication Fee (No small entity discount permitted)</p> <p><input type="checkbox"/> Advance Order - # of Copies _____</p>	<p>4b. Payment of Fee(s): (Please first reapply any previously paid issue fee shown above)</p> <p><input type="checkbox"/> A check is enclosed.</p> <p><input type="checkbox"/> Payment by credit card. Form PTO-2038 is attached.</p> <p><input type="checkbox"/> The Director is hereby authorized to charge the required fee(s), any deficiency, or credit any overpayment, to Deposit Account Number _____ (enclose an extra copy of this form).</p>
---	--

5. Change in Entity Status (from status indicated above)

a. Applicant claims SMALL ENTITY status. See 37 CFR 1.27. b. Applicant is no longer claiming SMALL ENTITY status. See 37 CFR 1.27(g)(2).

NOTE: The Issue Fee and Publication Fee (if required) will not be accepted from anyone other than the applicant; a registered attorney or agent; or the assignee or other party in interest as shown by the records of the United States Patent and Trademark Office.

Authorized Signature _____ Date _____

Typed or printed name _____ Registration No. _____

This collection of information is required by 37 CFR 1.311. The information is required to obtain or retain a benefit by the public which is to file (and by the USPTO to process) an application. Confidentiality is governed by 35 U.S.C. 122 and 37 CFR 1.14. This collection is estimated to take 12 minutes to complete, including gathering, preparing, and submitting the completed application form to the USPTO. Time will vary depending upon the individual case. Any comments on the amount of time you require to complete this form and/or suggestions for reducing this burden, should be sent to the Chief Information Officer, U.S. Patent and Trademark Office, U.S. Department of Commerce, P.O. Box 1450, Alexandria, Virginia 22313-1450. DO NOT SEND FEES OR COMPLETED FORMS TO THIS ADDRESS. SEND TO: Commissioner for Patents, P.O. Box 1450, Alexandria, Virginia 22313-1450.

Under the Paperwork Reduction Act of 1995, no persons are required to respond to a collection of information unless it displays a valid OMB control number.



UNITED STATES PATENT AND TRADEMARK OFFICE

UNITED STATES DEPARTMENT OF COMMERCE
United States Patent and Trademark Office
Address: COMMISSIONER FOR PATENTS
P.O. Box 1450
Alexandria, Virginia 22313-1450
www.uspto.gov

Table with 5 columns: APPLICATION NO., FILING DATE, FIRST NAMED INVENTOR, ATTORNEY DOCKET NO., CONFIRMATION NO.

97664 7590 04/27/2011
Huawei Technologies Co., Ltd./Finnegan
901 New York Avenue
NW
Washington, DC 20001

EXAMINER

TIEU, BINH KIEN

ART UNIT PAPER NUMBER

2614

DATE MAILED: 04/27/2011

Determination of Patent Term Adjustment under 35 U.S.C. 154 (b)
(application filed on or after May 29, 2000)

The Patent Term Adjustment to date is 763 day(s). If the issue fee is paid on the date that is three months after the mailing date of this notice and the patent issues on the Tuesday before the date that is 28 weeks (six and a half months) after the mailing date of this notice, the Patent Term Adjustment will be 763 day(s).

If a Continued Prosecution Application (CPA) was filed in the above-identified application, the filing date that determines Patent Term Adjustment is the filing date of the most recent CPA.

Applicant will be able to obtain more detailed information by accessing the Patent Application Information Retrieval (PAIR) WEB site (http://pair.uspto.gov).

Any questions regarding the Patent Term Extension or Adjustment determination should be directed to the Office of Patent Legal Administration at (571)-272-7702. Questions relating to issue and publication fee payments should be directed to the Customer Service Center of the Office of Patent Publication at 1-(888)-786-0101 or (571)-272-4200.

Privacy Act Statement

The Privacy Act of 1974 (P.L. 93-579) requires that you be given certain information in connection with your submission of the attached form related to a patent application or patent. Accordingly, pursuant to the requirements of the Act, please be advised that: (1) the general authority for the collection of this information is 35 U.S.C. 2(b)(2); (2) furnishing of the information solicited is voluntary; and (3) the principal purpose for which the information is used by the U.S. Patent and Trademark Office is to process and/or examine your submission related to a patent application or patent. If you do not furnish the requested information, the U.S. Patent and Trademark Office may not be able to process and/or examine your submission, which may result in termination of proceedings or abandonment of the application or expiration of the patent.

The information provided by you in this form will be subject to the following routine uses:

1. The information on this form will be treated confidentially to the extent allowed under the Freedom of Information Act (5 U.S.C. 552) and the Privacy Act (5 U.S.C. 552a). Records from this system of records may be disclosed to the Department of Justice to determine whether disclosure of these records is required by the Freedom of Information Act.
2. A record from this system of records may be disclosed, as a routine use, in the course of presenting evidence to a court, magistrate, or administrative tribunal, including disclosures to opposing counsel in the course of settlement negotiations.
3. A record in this system of records may be disclosed, as a routine use, to a Member of Congress submitting a request involving an individual, to whom the record pertains, when the individual has requested assistance from the Member with respect to the subject matter of the record.
4. A record in this system of records may be disclosed, as a routine use, to a contractor of the Agency having need for the information in order to perform a contract. Recipients of information shall be required to comply with the requirements of the Privacy Act of 1974, as amended, pursuant to 5 U.S.C. 552a(m).
5. A record related to an International Application filed under the Patent Cooperation Treaty in this system of records may be disclosed, as a routine use, to the International Bureau of the World Intellectual Property Organization, pursuant to the Patent Cooperation Treaty.
6. A record in this system of records may be disclosed, as a routine use, to another federal agency for purposes of National Security review (35 U.S.C. 181) and for review pursuant to the Atomic Energy Act (42 U.S.C. 218(c)).
7. A record from this system of records may be disclosed, as a routine use, to the Administrator, General Services, or his/her designee, during an inspection of records conducted by GSA as part of that agency's responsibility to recommend improvements in records management practices and programs, under authority of 44 U.S.C. 2904 and 2906. Such disclosure shall be made in accordance with the GSA regulations governing inspection of records for this purpose, and any other relevant (i.e., GSA or Commerce) directive. Such disclosure shall not be used to make determinations about individuals.
8. A record from this system of records may be disclosed, as a routine use, to the public after either publication of the application pursuant to 35 U.S.C. 122(b) or issuance of a patent pursuant to 35 U.S.C. 151. Further, a record may be disclosed, subject to the limitations of 37 CFR 1.14, as a routine use, to the public if the record was filed in an application which became abandoned or in which the proceedings were terminated and which application is referenced by either a published application, an application open to public inspection or an issued patent.
9. A record from this system of records may be disclosed, as a routine use, to a Federal, State, or local law enforcement agency, if the USPTO becomes aware of a violation or potential violation of law or regulation.

Notice of Allowability	Application No.	Applicant(s)	
	11/502,921	DUAN, XIAOQIN	
	Examiner	Art Unit	
	BINH K. TIEU	2614	

-- The MAILING DATE of this communication appears on the cover sheet with the correspondence address--

All claims being allowable, PROSECUTION ON THE MERITS IS (OR REMAINS) CLOSED in this application. If not included herewith (or previously mailed), a Notice of Allowance (PTOL-85) or other appropriate communication will be mailed in due course. **THIS NOTICE OF ALLOWABILITY IS NOT A GRANT OF PATENT RIGHTS.** This application is subject to withdrawal from issue at the initiative of the Office or upon petition by the applicant. See 37 CFR 1.313 and MPEP 1308.

1. This communication is responsive to 04/20/2011.
2. The allowed claim(s) is/are 18-25.
3. Acknowledgment is made of a claim for foreign priority under 35 U.S.C. § 119(a)-(d) or (f).
 - a) All b) Some* c) None of the:
 1. Certified copies of the priority documents have been received.
 2. Certified copies of the priority documents have been received in Application No. _____.
 3. Copies of the certified copies of the priority documents have been received in this national stage application from the International Bureau (PCT Rule 17.2(a)).

* Certified copies not received: _____.

Applicant has THREE MONTHS FROM THE "MAILING DATE" of this communication to file a reply complying with the requirements noted below. Failure to timely comply will result in ABANDONMENT of this application.
THIS THREE-MONTH PERIOD IS NOT EXTENDABLE.

4. A SUBSTITUTE OATH OR DECLARATION must be submitted. Note the attached EXAMINER'S AMENDMENT or NOTICE OF INFORMAL PATENT APPLICATION (PTO-152) which gives reason(s) why the oath or declaration is deficient.
5. CORRECTED DRAWINGS (as "replacement sheets") must be submitted.
 - (a) including changes required by the Notice of Draftsperson's Patent Drawing Review (PTO-948) attached
 - 1) hereto or 2) to Paper No./Mail Date _____.
 - (b) including changes required by the attached Examiner's Amendment / Comment or in the Office action of Paper No./Mail Date _____.

Identifying indicia such as the application number (see 37 CFR 1.84(c)) should be written on the drawings in the front (not the back) of each sheet. Replacement sheet(s) should be labeled as such in the header according to 37 CFR 1.121(d).
6. DEPOSIT OF and/or INFORMATION about the deposit of BIOLOGICAL MATERIAL must be submitted. Note the attached Examiner's comment regarding REQUIREMENT FOR THE DEPOSIT OF BIOLOGICAL MATERIAL.

Attachment(s)

- | | |
|--|--|
| 1. <input checked="" type="checkbox"/> Notice of References Cited (PTO-892) | 5. <input type="checkbox"/> Notice of Informal Patent Application |
| 2. <input type="checkbox"/> Notice of Draftsperson's Patent Drawing Review (PTO-948) | 6. <input type="checkbox"/> Interview Summary (PTO-413),
Paper No./Mail Date _____. |
| 3. <input type="checkbox"/> Information Disclosure Statements (PTO/SB/08),
Paper No./Mail Date _____ | 7. <input type="checkbox"/> Examiner's Amendment/Comment |
| 4. <input type="checkbox"/> Examiner's Comment Regarding Requirement for Deposit
of Biological Material | 8. <input checked="" type="checkbox"/> Examiner's Statement of Reasons for Allowance |
| | 9. <input type="checkbox"/> Other _____. |

/BINH K. TIEU/
 Primary Examiner, Art Unit 2614

DETAILED ACTION

Response to Amendment

1. The Applicant's amendment filed on 04/20/2011 was received and entered. As the results, claims 1-17 and 26-35 were cancelled as indicated by the Applicant. Claims 18-25 are pending in this Application.

Allowable Subject Matter

2. Claims 18-25 are allowed.

3. The following is an examiner's statement of reasons for allowance:

There are references which each teaches a system and a method for controlling charging of packet data service. However, none of them, alone or in combination, teaches the logical sequent steps of a method in connections with a Traffic Plane Function (TPF) and a Charging Rule Function (CRF), as recited in the method independent claim 18.

Also, the references also failed to clearly teach or fairly suggest the system having the combination of elements with their specific functions, as recited in the method independent claim 22.

Any comments considered necessary by applicant must be submitted no later than the payment of the issue fee and, to avoid processing delays, should preferably

Art Unit: 2614

accompany the issue fee. Such submissions should be clearly labeled "Comments on Statement of Reasons for Allowance."

4. Any inquiry concerning this communication or earlier communications from the examiner should be directed to Binh K. Tieu whose telephone number is (571) 272-7510, Fax number is (571) 273-7510 and E-mail address: BINH.TIEU@USPTO.GOV.

If attempts to reach the examiner by telephone are unsuccessful, the examiner's Email at BINH.TIEU@USPTO.GOV or supervisor, Mr. Curtis Kuntz, can be reached on (571) 272-7499.

Any response to this action should be mailed to:
Commissioner of Patents and Trademarks
Washington, D.C. 20231
Or faxed to: (571) 273-8300
Hand Carry Deliveries to:
Customer Service Window
(Randolph Building)
401 Dulany Street
Alexandria, VA 22314

Information regarding the status of an application may be obtained from the Patent Application Information Retrieval (PAIR) system. Status information for published applications may be obtained from either Private PAIR or Public PAIR. Status information for unpublished applications is available through Private PAIR only. For more information about the PAIR system, see <http://pair-direct.uspto.gov>. If you have any questions on access to the Private PAIR system, contact the Electronic Business Center (EBC) at 866-217-9197 (toll-free).

/BINH K. TIEU/
Primary Examiner
Technology Division 2614

Date: April 2011

Notice of References Cited	Application/Control No. 11/502,921	Applicant(s)/Patent Under Reexamination DUAN, XIAOQIN	
	Examiner BINH K. TIEU	Art Unit 2614	Page 1 of 2

U.S. PATENT DOCUMENTS

*	Document Number Country Code-Number-Kind Code	Date MM-YYYY	Name	Classification	
*	A	US-2004/0017905	01-2004	Warrier et al.	379/114.15
*	B	US-2004/0127194	07-2004	Lippelt, Hans-Peter	455/406
*	C	US-2002/0129088	09-2002	Zhou et al.	709/200
*	D	US-5,963,625	10-1999	Kawecki et al.	379/127.01
*	E	US-2002/0138331	09-2002	Hosea et al.	705/10
*	F	US-2006/0050711	03-2006	Lialiamou et al.	370/395.2
*	G	US-7,260,193	08-2007	Zackrisson et al.	379/114.28
*	H	US-7,266,116	09-2007	Halpern, Joel M.	370/352
*	I	US-2003/0200313	10-2003	Peterka et al.	709/225
*	J	US-2002/0129088	09-2002	Zhou et al.	709/200
*	K	US-5,917,897	06-1999	Johnson et al.	379/114.02
*	L	US-6,434,380	08-2002	Andersson et al.	455/406
*	M	US-2002/0101858	08-2002	Stuart et al.	370/352

FOREIGN PATENT DOCUMENTS

*	Document Number Country Code-Number-Kind Code	Date MM-YYYY	Country	Name	Classification
*	N				
*	O				
*	P				
*	Q				
*	R				
*	S				
*	T				

NON-PATENT DOCUMENTS

*	Include as applicable: Author, Title Date, Publisher, Edition or Volume, Pertinent Pages)
*	U
*	V
*	W
*	X

*A copy of this reference is not being furnished with this Office action. (See MPEP § 707.05(a).)
Dates in MM-YYYY format are publication dates. Classifications may be US or foreign.

Notice of References Cited	Application/Control No. 11/502,921	Applicant(s)/Patent Under Reexamination DUAN, XIAOQIN	
	Examiner BINH K. TIEU	Art Unit 2614	Page 2 of 2

U.S. PATENT DOCUMENTS

*	Document Number Country Code-Number-Kind Code	Date MM-YYYY	Name	Classification
*	A US-2006/0234674	10-2006	Koskinen et al.	455/406
*	B US-7,391,854	06-2008	Salonen et al.	379/114.2
*	C US-2003/0125013	07-2003	Mizell et al.	455/408
*	D US-7,689,203	03-2010	Zhang et al.	455/406
*	E US-2003/0165222	09-2003	Syrjala et al.	379/114.26
F	US-			
G	US-			
H	US-			
I	US-			
J	US-			
K	US-			
L	US-			
M	US-			

FOREIGN PATENT DOCUMENTS

*	Document Number Country Code-Number-Kind Code	Date MM-YYYY	Country	Name	Classification
N					
O					
P					
Q					
R					
S					
T					

NON-PATENT DOCUMENTS

*	Include as applicable: Author, Title Date, Publisher, Edition or Volume, Pertinent Pages)
U	
V	
W	
X	

*A copy of this reference is not being furnished with this Office action. (See MPEP § 707.05(a).)
Dates in MM-YYYY format are publication dates. Classifications may be US or foreign.

Issue Classification 	Application/Control No. 11502921	Applicant(s)/Patent Under Reexamination DUAN, XIAOQIN
	Examiner BINH K TIEU	Art Unit 2614

ORIGINAL						INTERNATIONAL CLASSIFICATION														
CLASS		SUBCLASS				CLAIMED					NON-CLAIMED									
370		252				G	0	1	R	31 / 08 (2006.01.01)										
CROSS REFERENCE(S)						G	0	6	F	11 / 00 (2006.01.01)										
						G	0	8	C	15 / 00 (2006.01.01)										
						H	0	4	J	1 / 16 (2006.01.01)										
CLASS	SUBCLASS (ONE SUBCLASS PER BLOCK)					H	0	4	J	3 / 14 (2006.01.01)										
455	406					H	0	4	J	1 / 00 (2006.01.01)										
						H	0	4	L	1 / 00 (2006.01.01)										
						H	0	4	L	12 / 26 (2006.01.01)										

Claims renumbered in the same order as presented by applicant
 CPA
 T.D.
 R.1.47

Final	Original	Final	Original	Final	Original	Final	Original	Final	Original	Final	Original	Final	Original	Final	Original
	1		17		33										
	2	1	18		34										
	3	2	19		35										
	4	3	20												
	5	4	21												
	6	5	22												
	7	6	23												
	8	7	24												
	9	8	25												
	10		26												
	11		27												
	12		28												
	13		29												
	14		30												
	15		31												
	16		32												

NONE		Total Claims Allowed:	
(Assistant Examiner)	(Date)	8	
/BINH K TIEU/ Primary Examiner. Art Unit 2614	04/22/2011	O.G. Print Claim(s)	O.G. Print Figure
(Primary Examiner)	(Date)	1	6

OK. To Enter.
Ex. /BKT/
AU 2614
04/22/2011

**RESPONSE UNDER 37 C.F.R. § 1.116
EXPEDITED PROCEDURE REQUESTED
EXAMINING GROUP 2614
PATENT**
Attorney Docket No. 11005.0219-00000
Huawei Ref. No. 0410606US

IN THE UNITED STATES PATENT AND TRADEMARK OFFICE

In re Application of:)
Xiaoqin DUAN) Group Art Unit: 2614
Application No.: 11/502,921) Examiner: Tieu, Binh Kien
Filed: August 11, 2006) Confirmation No: 9151
For: METHOD FOR CONTROLLING CHARGING)
OF PACKET DATA SERVICE)

Dear Sir:

AMENDMENT AFTER FINAL

In reply to the Final Office Action mailed February 24, 2011, the period for response to which extends through May 24, 2011, and pursuant to 37 C.F.R. § 1.116, Applicant proposes that this application be amended as follows:

Amendments to the Claims are reflected in the listing of claims which begins on page 2 of this paper.

Remarks begin on page 5 of this paper.

WEST Search History for Application 11502921

Creation Date: 2011042214:31

Prior Art Searches

Query	DB	Op.	Plur.	Thes.	Date
traffic plane or plane function or tpt	PGPB, USPT, USOC, EPAB, JPAB, DWPI, TDBD	ADJ	YES		04-22-2011
charg\$3 rule or rule function or crf	PGPB, USPT, USOC, EPAB, JPAB, DWPI, TDBD	ADJ	YES		04-22-2011
(charg\$3 rule or rule function or crf) and (traffic plane or plane function or tpt)	PGPB, USPT, USOC, EPAB, JPAB, DWPI, TDBD	ADJ	YES		04-22-2011
trigger with met	PGPB, USPT, USOC, EPAB, JPAB, DWPI, TDBD	ADJ	YES		04-22-2011
(trigger with met) and (charg\$3 rule or rule function or crf and traffic plane or plane function or tpt)	PGPB, USPT, USOC, EPAB, JPAB, DWPI, TDBD	ADJ	YES		04-22-2011
(charg\$3 rule or rule function or crf and traffic plane or plane function or tpt) not (trigger with met and charg\$3 rule or rule function or crf and traffic plane or plane function or tpt)	PGPB, USPT, USOC, EPAB, JPAB, DWPI, TDBD	ADJ	YES		04-22-2011
credit control or control function or ccf	PGPB, USPT, USOC, EPAB, JPAB, DWPI, TDBD	ADJ	YES		04-22-2011
(credit control or control function or ccf) and (charg\$3 rule or rule function or crf and traffic plane or plane function or tpt)	PGPB, USPT, USOC, EPAB, JPAB, DWPI, TDBD	ADJ	YES		04-22-2011
charg\$3 (gateway or gate-way) or (gateway or gate-way) function or cgf	PGPB, USPT, USOC, EPAB, JPAB, DWPI, TDBD	ADJ	YES		04-22-2011

(charg\$3 (gateway or gate-way) or (gateway or gate-way) function or cgf) and (credit control or control function or ccf and charg\$3 rule or rule function or crf and traffic plane or plane function or tpt)	PGPB, USPT, USOC, EPAB, JPAB, DWPI, TDBD	ADJ	YES		04-22-2011
---	---	------------	------------	--	-------------------

Index of Claims 	Application/Control No. 11502921	Applicant(s)/Patent Under Reexamination DUAN, XIAOQIN
	Examiner BINH K TIEU	Art Unit 2614

✓	Rejected
=	Allowed

-	Cancelled
÷	Restricted

N	Non-Elected
I	Interference

A	Appeal
O	Objected

Claims renumbered in the same order as presented by applicant
 CPA
 T.D.
 R.1.47

CLAIM		DATE							
Final	Original	11/04/2009	03/20/2010	07/05/2010	12/05/2010	02/23/2011	04/22/2011		
	1	✓	✓	✓	✓	✓	-		
	2	✓	✓	✓	✓	✓	-		
	3	✓	✓	✓	✓	✓	-		
	4	✓	✓	✓	✓	✓	-		
	5	✓	✓	✓	✓	✓	-		
	6	✓	✓	✓	✓	✓	-		
	7		✓	✓	✓	✓	-		
	8		✓	✓	✓	-	-		
	9		✓	✓	✓	-	-		
	10		✓	✓	✓	-	-		
	11		✓	✓	✓	-	-		
	12		✓	✓	✓	-	-		
	13		✓	✓	✓	-	-		
	14		✓	✓	✓	-	-		
	15		✓	✓	✓	-	-		
	16		✓	✓	✓	-	-		
	17		✓	✓	✓	-	-		
1	18				O	=	=		
2	19				O	=	=		
3	20				O	=	=		
4	21				O	=	=		
5	22				O	=	=		
6	23				O	=	=		
7	24				O	=	=		
8	25				O	=	=		
	26					✓	-		
	27					✓	-		
	28					✓	-		
	29					✓	-		
	30					✓	-		
	31					✓	-		
	32					✓	-		
	33					✓	-		
	34					✓	-		
	35					✓	-		

Search Notes 	Application/Control No. 11502921	Applicant(s)/Patent Under Reexamination DUAN, XIAOQIN
	Examiner BINH K TIEU	Art Unit 2614

SEARCHED			
Class	Subclass	Date	Examiner
379	111, 114.01, 114.03, 114.05, 114.12, 115.01, 121.01, 124	11/05/2009	BKT
370	356-360, 401	11/05/2009	BKT
UPDATED	SEARCHES	03/20/2010	BKT
455	405-408	03/20/2010	BKT
UPDATED	SEARCHES	07/04/2010	BKT
UPDATED	SEARCHES	12/05/2010	BKT
UPDATED	SEARCHES	02/23/2011	BKT
UPDATED	SEARCHES	04/22/2011	BKT

SEARCH NOTES		
Search Notes	Date	Examiner
WEST DATABASES TERMS SEARCHES	11/05/2009	BKT
WEST DATABASES TERMS SEARCHES	03/19/2010	BKT
WEST DATABASES TERMS SEARCHES	07/04/2010	BKT
WEST DATABASES TERMS SEARCHES	12/05/2010	BKT
WEST DATABASES TERMS SEARCHES	04/22/2011	BKT

INTERFERENCE SEARCH			
Class	Subclass	Date	Examiner
370	252	04/22/2011	BKT
455	406	04/22/2011	BKT

--	--

**RESPONSE UNDER 37 C.F.R. § 1.116
EXPEDITED PROCEDURE REQUESTED
EXAMINING GROUP 2614
PATENT
Attorney Docket No. 11005.0219-00000
Huawei Ref. No. 0410606US**

IN THE UNITED STATES PATENT AND TRADEMARK OFFICE

In re Application of:)	
)	Group Art Unit: 2614
Xiaoqin DUAN)	
)	Examiner: Tieu, Binh Kien
Application No.: 11/502,921)	
)	Confirmation No: 9151
Filed: August 11, 2006)	
)	
For: METHOD FOR CONTROLLING CHARGING)	
OF PACKET DATA SERVICE)	

Dear Sir:

AMENDMENT AFTER FINAL

In reply to the Final Office Action mailed February 24, 2011, the period for response to which extends through May 24, 2011, and pursuant to 37 C.F.R. § 1.116, Applicant proposes that this application be amended as follows:

Amendments to the Claims are reflected in the listing of claims which begins on page 2 of this paper.

Remarks begin on page 5 of this paper.

AMENDMENTS TO THE CLAIMS

This listing of claims will replace all prior versions, and listings, of claims in the application.

Listing of Claims:

1-17 (Canceled)

18. (Previously presented) A method for controlling charging of packet data service, comprising:

monitoring, by a Traffic Plane Function (TPF), an event trigger provided by a Charging Rule Function (CRF);

sending, by the TPF, a charging rule request to the CRF, if the event trigger is met; receiving, by the TPF, a charging rule from the CRF in a charging rule provision procedure; and

taking, by the TPF, statistics of charging information according to the received charging rule.

19. (Previously presented) The method according to Claim 18, further comprising: sending, by the TPF, the statistics to a Credit Control Function (CCF) in an Online Charging System (OCS); or

sending, by the TPF, the statistics to a Charging Gateway Function (CGF) and a Charging Collection Function (CCF) in an offline charging system.

20. (Previously presented) The method according to Claim 19, wherein the TPF is a Gateway General Packet Radio Service (GPRS) Support Node (GGSN) in a GPRS.

21. (Previously presented) The method according to Claim 19, further comprising:
receiving, by the TPF, a Modify Bearer Service Request from a User Equipment (UE);
after receiving the Modify Bearer Service Request, the TPF performs the monitoring step.

22. (Previously presented) A Traffic Plane Function (TPF) for controlling charging of packet data service, comprising:

a monitoring unit, configured to monitor an event trigger provided by a Charging Rule Function (CRF);

a sending unit, configured to send a charging rule request to the CRF if the event trigger is met;

a receiving unit, configured to receive a charging rule from the CRF in a charging rule provision procedure; and

a statistics taking unit, configured to take statistics of a charging information according to the Provision Charging Rule.

23. (Previously presented) The TPF according to Claim 22, further comprising:
a second sending unit, configured to send the statistics to a Credit Control Function (CCF) in an Online Charging System (OCS), or to send the statistics to a Charging Gateway Function (CGF) and a Charging Collection Function (CCF) in an offline charging system.

24. (Previously presented) The TPF according to Claim 23, wherein the TPF is a Gateway General Packet Radio Service (GPRS) Support Node (GGSN) in a GPRS.

25. (Previously presented) The TPF according to Claim 23, further comprising:
a second receiving unit, configured to receive a Modify Bearer Service Request from a User Equipment (UE).

26-35 (Canceled)

REMARKS

In the final Office Action, the Examiner rejected claims 1-7 and 26-35 under 35 U.S.C. § 103(a) as being unpatentable over U.S. Pub No. 2003/0165222 A1 (“Syrjala”) in view of U.S. Patent No. 6,985,567 (“Vallinen”); and allowed claims 18-25.

Applicant gratefully acknowledges the Examiner’s allowance of claims 18-25. Applicant respectfully traverses the rejection of claims 1-7 and 26-35. However, solely to advance prosecution, Applicant proposes to cancel claims 1-7 and 26-35 without prejudice or disclaimer of their subject matter, rendering their rejection moot.

Conclusion

This Amendment after Final merely proposes cancelation of claims 1-7 and 26-35. The remaining claims 18-25 are allowed. Accordingly, Applicant respectfully requests entry of the amendments and a timely allowance of this application.

If there are any remaining issues or misunderstandings, Applicant requests that the Examiner telephone the undersigned representative to discuss them.

Please grant any extensions of time required to enter this response and charge any additional required fees to our deposit account 06-0916.

Respectfully submitted,

FINNEGAN, HENDERSON, FARABOW,
GARRETT & DUNNER, L.L.P.

Dated: April 20, 2011

By: /Weiguo Chen/
Weiguo Chen
Reg. No. 61,878
(650) 849-6729

Electronic Acknowledgement Receipt

EFS ID:	9923840
Application Number:	11502921
International Application Number:	
Confirmation Number:	9151
Title of Invention:	Method for controlling charging of packet data service
First Named Inventor/Applicant Name:	Xiaoqin Duan
Customer Number:	97664
Filer:	Weiguo Chen/Margie Harris
Filer Authorized By:	Weiguo Chen
Attorney Docket Number:	11005.0219-00000
Receipt Date:	20-APR-2011
Filing Date:	11-AUG-2006
Time Stamp:	18:33:30
Application Type:	Utility under 35 USC 111(a)

Payment information:

Submitted with Payment	no
------------------------	----

File Listing:

Document Number	Document Description	File Name	File Size(Bytes)/ Message Digest	Multi Part /.zip	Pages (if appl.)
1		AmendmentAfterFinal.pdf	133164 <small>7b91935bda40e2a9c02b1c73c19b5d2f9d598a28</small>	yes	5

Multipart Description/PDF files in .zip description			
Document Description	Start	End	
Amendment After Final	1	1	
Claims	2	4	
Applicant Arguments/Remarks Made in an Amendment	5	5	

Warnings:

Information:

Total Files Size (in bytes):	133164
-------------------------------------	--------

This Acknowledgement Receipt evidences receipt on the noted date by the USPTO of the indicated documents, characterized by the applicant, and including page counts, where applicable. It serves as evidence of receipt similar to a Post Card, as described in MPEP 503.

New Applications Under 35 U.S.C. 111

If a new application is being filed and the application includes the necessary components for a filing date (see 37 CFR 1.53(b)-(d) and MPEP 506), a Filing Receipt (37 CFR 1.54) will be issued in due course and the date shown on this Acknowledgement Receipt will establish the filing date of the application.

National Stage of an International Application under 35 U.S.C. 371

If a timely submission to enter the national stage of an international application is compliant with the conditions of 35 U.S.C. 371 and other applicable requirements a Form PCT/DO/EO/903 indicating acceptance of the application as a national stage submission under 35 U.S.C. 371 will be issued in addition to the Filing Receipt, in due course.

New International Application Filed with the USPTO as a Receiving Office

If a new international application is being filed and the international application includes the necessary components for an international filing date (see PCT Article 11 and MPEP 1810), a Notification of the International Application Number and of the International Filing Date (Form PCT/RO/105) will be issued in due course, subject to prescriptions concerning national security, and the date shown on this Acknowledgement Receipt will establish the international filing date of the application.

Under the Paperwork Reduction Act of 1995, no persons are required to respond to a collection of information unless it displays a valid OMB control number.

PATENT APPLICATION FEE DETERMINATION RECORD Substitute for Form PTO-875					Application or Docket Number 11/502,921		Filing Date 08/11/2006		<input type="checkbox"/> To be Mailed		
APPLICATION AS FILED – PART I											
(Column 1)			(Column 2)		SMALL ENTITY <input type="checkbox"/>			OR		OTHER THAN SMALL ENTITY	
FOR		NUMBER FILED	NUMBER EXTRA		RATE (\$)	FEE (\$)	OR		RATE (\$)	FEE (\$)	
<input type="checkbox"/> BASIC FEE (37 CFR 1.16(a), (b), or (c))		N/A	N/A		N/A		OR		N/A		
<input type="checkbox"/> SEARCH FEE (37 CFR 1.16(k), (i), or (m))		N/A	N/A		N/A		OR		N/A		
<input type="checkbox"/> EXAMINATION FEE (37 CFR 1.16(o), (p), or (q))		N/A	N/A		N/A		OR		N/A		
TOTAL CLAIMS (37 CFR 1.16(i))		minus 20 =	*		X \$ =		OR		X \$ =		
INDEPENDENT CLAIMS (37 CFR 1.16(h))		minus 3 =	*		X \$ =		OR		X \$ =		
<input type="checkbox"/> APPLICATION SIZE FEE (37 CFR 1.16(s))		If the specification and drawings exceed 100 sheets of paper, the application size fee due is \$250 (\$125 for small entity) for each additional 50 sheets or fraction thereof. See 35 U.S.C. 41(a)(1)(G) and 37 CFR 1.16(s).									
<input type="checkbox"/> MULTIPLE DEPENDENT CLAIM PRESENT (37 CFR 1.16(j))											
* If the difference in column 1 is less than zero, enter "0" in column 2.											
APPLICATION AS AMENDED – PART II											
(Column 1)			(Column 2)		SMALL ENTITY			OR		OTHER THAN SMALL ENTITY	
AMENDMENT	04/20/2011	CLAIMS REMAINING AFTER AMENDMENT		HIGHEST NUMBER PREVIOUSLY PAID FOR	PRESENT EXTRA	RATE (\$)	ADDITIONAL FEE (\$)	OR		RATE (\$)	ADDITIONAL FEE (\$)
	Total (37 CFR 1.16(i))	* 8	Minus	** 25	= 0	X \$ =		OR		X \$2=	0
	Independent (37 CFR 1.16(h))	* 1	Minus	***5	= 0	X \$ =		OR		X \$220=	0
	<input type="checkbox"/> Application Size Fee (37 CFR 1.16(s))										
	<input type="checkbox"/> FIRST PRESENTATION OF MULTIPLE DEPENDENT CLAIM (37 CFR 1.16(j))										
						TOTAL ADD'L FEE	OR		TOTAL ADD'L FEE	0	
AMENDMENT		CLAIMS REMAINING AFTER AMENDMENT		HIGHEST NUMBER PREVIOUSLY PAID FOR	PRESENT EXTRA	RATE (\$)	ADDITIONAL FEE (\$)	OR		RATE (\$)	ADDITIONAL FEE (\$)
	Total (37 CFR 1.16(i))	*	Minus	**	=	X \$ =		OR		X \$ =	
	Independent (37 CFR 1.16(h))	*	Minus	***	=	X \$ =		OR		X \$ =	
	<input type="checkbox"/> Application Size Fee (37 CFR 1.16(s))										
	<input type="checkbox"/> FIRST PRESENTATION OF MULTIPLE DEPENDENT CLAIM (37 CFR 1.16(j))										
						TOTAL ADD'L FEE	OR		TOTAL ADD'L FEE		
* If the entry in column 1 is less than the entry in column 2, write "0" in column 3.											
** If the "Highest Number Previously Paid For" IN THIS SPACE is less than 20, enter "20".											
*** If the "Highest Number Previously Paid For" IN THIS SPACE is less than 3, enter "3".											
The "Highest Number Previously Paid For" (Total or Independent) is the highest number found in the appropriate box in column 1.											
Legal Instrument Examiner: /JACQUELINE M. WEIR/											

This collection of information is required by 37 CFR 1.16. The information is required to obtain or retain a benefit by the public which is to file (and by the USPTO to process) an application. Confidentiality is governed by 35 U.S.C. 122 and 37 CFR 1.14. This collection is estimated to take 12 minutes to complete, including gathering, preparing, and submitting the completed application form to the USPTO. Time will vary depending upon the individual case. Any comments on the amount of time you require to complete this form and/or suggestions for reducing this burden, should be sent to the Chief Information Officer, U.S. Patent and Trademark Office, U.S. Department of Commerce, P.O. Box 1450, Alexandria, VA 22313-1450. DO NOT SEND FEES OR COMPLETED FORMS TO THIS ADDRESS. **SEND TO: Commissioner for Patents, P.O. Box 1450, Alexandria, VA 22313-1450.**

If you need assistance in completing the form, call 1-800-PTO-9199 and select option 2.



UNITED STATES PATENT AND TRADEMARK OFFICE

UNITED STATES DEPARTMENT OF COMMERCE
United States Patent and Trademark Office
Address: COMMISSIONER FOR PATENTS
P.O. Box 1450
Alexandria, Virginia 22313-1450
www.uspto.gov

APPLICATION NUMBER	PATENT NUMBER	GROUP ART UNIT	FILE WRAPPER LOCATION
11/502,921		2614	2614



Correspondence Address/Fee Address Change

The following fields have been set to Customer Number 97664 on 08/02/2010

- Correspondence Address
- Power of Attorney Address

The address of record for Customer Number 97664 is:

97664
Huawei Technologies Co., Ltd./Finnegan
901 New York Avenue
NW
Washington, DC 20001



UNITED STATES PATENT AND TRADEMARK OFFICE

UNITED STATES DEPARTMENT OF COMMERCE
United States Patent and Trademark Office
Address: COMMISSIONER FOR PATENTS
P.O. Box 1450
Alexandria, Virginia 22313-1450
www.uspto.gov

APPLICATION NO.	FILING DATE	FIRST NAMED INVENTOR	ATTORNEY DOCKET NO.	CONFIRMATION NO.
11/502,921	08/11/2006	Xiaoqin Duan	11005.0219-00000	9151
97664	7590	02/24/2011	EXAMINER	
Huawei Technologies Co., Ltd./Finnegan			TIEU, BINH KIEN	
901 New York Avenue			ART UNIT	PAPER NUMBER
NW			2614	
Washington, DC 20001			MAIL DATE	DELIVERY MODE
			02/24/2011	PAPER

Please find below and/or attached an Office communication concerning this application or proceeding.

The time period for reply, if any, is set in the attached communication.

Office Action Summary	Application No. 11/502,921	Applicant(s) DUAN, XIAOQIN	
	Examiner BINH K. TIEU	Art Unit 2614	

-- The MAILING DATE of this communication appears on the cover sheet with the correspondence address --

Period for Reply

A SHORTENED STATUTORY PERIOD FOR REPLY IS SET TO EXPIRE 3 MONTH(S) OR THIRTY (30) DAYS, WHICHEVER IS LONGER, FROM THE MAILING DATE OF THIS COMMUNICATION.

- Extensions of time may be available under the provisions of 37 CFR 1.136(a). In no event, however, may a reply be timely filed after SIX (6) MONTHS from the mailing date of this communication.
- If NO period for reply is specified above, the maximum statutory period will apply and will expire SIX (6) MONTHS from the mailing date of this communication.
- Failure to reply within the set or extended period for reply will, by statute, cause the application to become ABANDONED (35 U.S.C. § 133). Any reply received by the Office later than three months after the mailing date of this communication, even if timely filed, may reduce any earned patent term adjustment. See 37 CFR 1.704(b).

Status

- 1) Responsive to communication(s) filed on 10 February 2011.
- 2a) This action is **FINAL**. 2b) This action is non-final.
- 3) Since this application is in condition for allowance except for formal matters, prosecution as to the merits is closed in accordance with the practice under *Ex parte Quayle*, 1935 C.D. 11, 453 O.G. 213.

Disposition of Claims

- 4) Claim(s) 1-7 and 18-35 is/are pending in the application.
4a) Of the above claim(s) _____ is/are withdrawn from consideration.
- 5) Claim(s) 18-25 is/are allowed.
- 6) Claim(s) 1-7, 26-35 is/are rejected.
- 7) Claim(s) _____ is/are objected to.
- 8) Claim(s) _____ are subject to restriction and/or election requirement.

Application Papers

- 9) The specification is objected to by the Examiner.
- 10) The drawing(s) filed on _____ is/are: a) accepted or b) objected to by the Examiner.
Applicant may not request that any objection to the drawing(s) be held in abeyance. See 37 CFR 1.85(a).
Replacement drawing sheet(s) including the correction is required if the drawing(s) is objected to. See 37 CFR 1.121(d).
- 11) The oath or declaration is objected to by the Examiner. Note the attached Office Action or form PTO-152.

Priority under 35 U.S.C. § 119

- 12) Acknowledgment is made of a claim for foreign priority under 35 U.S.C. § 119(a)-(d) or (f).
a) All b) Some * c) None of:
 1. Certified copies of the priority documents have been received.
 2. Certified copies of the priority documents have been received in Application No. _____.
 3. Copies of the certified copies of the priority documents have been received in this National Stage application from the International Bureau (PCT Rule 17.2(a)).

* See the attached detailed Office action for a list of the certified copies not received.

Attachment(s)

- 1) Notice of References Cited (PTO-892)
- 2) Notice of Draftsperson's Patent Drawing Review (PTO-948)
- 3) Information Disclosure Statement(s) (PTO/SB/08)
Paper No(s)/Mail Date _____.
- 4) Interview Summary (PTO-413)
Paper No(s)/Mail Date. _____.
- 5) Notice of Informal Patent Application
- 6) Other: _____.

DETAILED ACTION

Response to Amendment

1. The Applicant's amendment filed on 02/10/2011 was entered. As the results, claims 8-17 were canceled. New claims 26-35 were added. At this time, claims 1-7 and 26-35 are pending in this application.

Claim Rejections - 35 USC § 103

2. The following is a quotation of 35 U.S.C. 103(a) which forms the basis for all obviousness rejections set forth in this Office action:

(a) A patent may not be obtained though the invention is not identically disclosed or described as set forth in section 102 of this title, if the differences between the subject matter sought to be patented and the prior art are such that the subject matter as a whole would have been obvious at the time the invention was made to a person having ordinary skill in the art to which said subject matter pertains. Patentability shall not be negated by the manner in which the invention was made.

3. Claims 1-7 and 26-35 are rejected under 35 U.S.C. 103(a) as being unpatentable over Syrjala et al. (US. Pat. #: 7,017,050, **as cited in the previous Office Action**) in view of Vallinen et al. (US. Pat. #: 6,985,567).

Regarding claims 1, 26 and 32, Syrjala et al. ("Syrjala") teaches a universal mobile communications system (UMTS) system 1 comprising an access layer A and a Telephony layer T as shown separated in figure 1. The telephony layer T comprises IP network, a call state control function (CSCF), a media gateway control function (MGCF) and an execution environment (CSE-T) which corresponding to a service control point in an intelligent network. The access layer A comprises a UMTS terrestrial radio access network (UTRAN) and a core network (CN). The CN comprises at least support nodes

Art Unit: 2614

SGSN and GGSN. When user equipment (UE) requests a service by transmitting a connection setup request to the CSCF via the SGSN and GGSN, the reception of the call set-up request results in encountering, at the CSCF, a trigger as (Detection Point) to initiate the service, which cause the CSCF to transmit a request for instructions to the service control function CSE_T. At the CSE_T, information about a prepaid subscription, and the service control function CSE_A is responsible for the prepaid account of the prepaid subscription is determined and located in a database of the CSE_T, i.e., matching to the telephone number of the caller (***see paragraph [0037], it should be understood that the access layer T with the CSCF and CSE_T performed as a Traffic Plane Function (TPF)***). The CSE_T then instructs the CSCF to send a message, included tariff of the telephony operator and all special events, to the CSE_A located in the access layer A as a charging rule request. Thus, ***the CSE_A performed as a Charging Rule Function (CRF), i.e., to apply a tariff to be charged to the prepaid account in according to a billing-related contract (see paragraphs [0038] and [0039]; or the access operator tariff information is requested from the CSE_A, paragraph [0043]***.

It should be noticed from the Applicant's remarks, filed on 02/10/2011 that Syrjala fails to clearly teach the features of "sending, by the TPF, a charging rule request to the CRF **to request a corresponding charging rule**, if the event trigger is met" as argued and amended to the claim by the Applicant. However, Vallinen et al. ("Vallinen") teaches a method of providing an advice of charge (AoC) using a Multipurpose Internet Mail Extension (MIME) indication. Vallinen teaches, in figure 1, that Call State Control

Function (CSCF) performs as a Traffic Plane Function (TPF) signaling between the IP network and the GGSN (see col.3, lines 9-12). Vallinen further teaches that the IP network contains different applications, such as application X. When the CSCF detects a trigger of a request sent from the user equipment (UE) for requesting a service charge of the application X. The CSCF makes a cost information request at the application X in the IP network. Thus, the application X in the IP network performs as "CRF" to respond for a return cost information to be sent back to the CSCF (see col.3, lines 26-37).

Therefore, it would have been obvious to one of ordinary skill in the art at the time the invention was made to incorporate the use of the features of "sending, by the TPF, a charging rule request to the CRF **to request a corresponding charging rule**, if the event trigger is met", as taught by Vallinen, into view of Syrjala in order to notify a charge of packet service to a end user.

Regarding claims 2, 6, 27, 33 and 34, Syrjala further teaches the telephone number of caller is used as "trigger" to detect the prepaid subscription of an account wherein the account information about services included, inter alia, use of basic telephone, different data bearers, etc. are set by the service provider of the CSE_A (see paragraphs [0037] and [0021]).

Regarding claims 3, 5, 29 and 31, Syrjala further teaches limitations of the claims such as the feature of setting "arming of detection points" in the CSCF in paragraph [0039].

Regarding claims 4 and 30, Syrjala further teaches the C_ID as limitations of the claims in paragraphs [0053] and [0054].

Regarding claims 7, 28 and 35, Syrjala further teaches the limitations of the claim in the figure 1, paragraphs [0021] and [0039].

Allowable Subject Matter

4. Claims 18-25 are allowed.

Response to Arguments

5. Applicant's arguments with respect to claims 1-8 have been considered but are moot in view of the new ground(s) of rejection.

Applicant's amendment necessitated the new ground(s) of rejection presented in this Office action. Accordingly, **THIS ACTION IS MADE FINAL**. See MPEP § 706.07(a). Applicant is reminded of the extension of time policy as set forth in 37 CFR 1.136(a).

A shortened statutory period for response to this final action is set to expire THREE MONTHS from the date of this action. In the event a first response is filed within TWO MONTHS of the mailing date of this final action and the advisory action is not mailed until after the end of the THREE-MONTH shortened statutory period, then the shortened statutory period will expire on the date the advisory action is mailed, and any extension fee pursuant to 37 CFR 1.136(a) will be calculated from the mailing date of the advisory action. In no event will the statutory period for response expire later than SIX MONTHS from the date of this final action.

Any response to this final action should be mailed to:

Box AF

Commissioner of Patents and Trademarks
Washington, D.C. 20231
Or faxed to:
(703) 872-9314 or (571) 273-8300 (for formal communications;
“EXPEDITED PROCEDURE”)
please mark
Or:
“PROPOSED” or “DRAFT”
If it is an informal or draft communication, please label
Hand Carry Deliveries to:
Customer Service Window
(Randolph Building)
401 Dulany Street
Alexandria, VA 22314

6. Any inquiry concerning this communication or earlier communications from the examiner should be directed to Binh K. Tieu whose telephone number is (571) 272-7510 and E-mail address: BINH.TIEU@USPTO.GOV.

If attempts to reach the examiner by telephone are unsuccessful, the examiner's supervisor, Mr. Curtis Kuntz, can be reached on (571) 272-7499.

Information regarding the status of an application may be obtained from the Patent Application Information Retrieval (PAIR) system. Status information for published applications may be obtained from either Private PAIR or Public PAIR. Status information for unpublished applications is available through Private PAIR only. For more information about the FAIR system, see <http://pair-direct.uspto.gov>. If you have any questions on access to the Private PAIR system, contact the Electronic Business Center (EBC) at 866-217-9197 (toll-free).

/BINH K. TIEU/
Primary Examiner
Technology Division 2614

Date: February 2011

Notice of References Cited	Application/Control No. 11/502,921	Applicant(s)/Patent Under Reexamination DUAN, XIAOQIN	
	Examiner BINH K. TIEU	Art Unit 2614	Page 1 of 1

U.S. PATENT DOCUMENTS

*	Document Number Country Code-Number-Kind Code	Date MM-YYYY	Name	Classification
*	A US-6,985,567	01-2006	Vallinen et al.	379/114.01
	B US-			
	C US-			
	D US-			
	E US-			
	F US-			
	G US-			
	H US-			
	I US-			
	J US-			
	K US-			
	L US-			
	M US-			

FOREIGN PATENT DOCUMENTS

*	Document Number Country Code-Number-Kind Code	Date MM-YYYY	Country	Name	Classification
	N				
	O				
	P				
	Q				
	R				
	S				
	T				

NON-PATENT DOCUMENTS

*	Include as applicable: Author, Title Date, Publisher, Edition or Volume, Pertinent Pages)
	U
	V
	W
	X

*A copy of this reference is not being furnished with this Office action. (See MPEP § 707.05(a).)
Dates in MM-YYYY format are publication dates. Classifications may be US or foreign.

<i>Index of Claims</i> 	Application/Control No. 11502921	Applicant(s)/Patent Under Reexamination DUAN, XIAOQIN
	Examiner BINH K TIEU	Art Unit 2614

✓	Rejected
=	Allowed

-	Cancelled
÷	Restricted

N	Non-Elected
I	Interference

A	Appeal
O	Objected

Claims renumbered in the same order as presented by applicant
 CPA
 T.D.
 R.1.47

CLAIM		DATE							
Final	Original	11/04/2009	03/20/2010	07/05/2010	12/05/2010	02/23/2011			
	1	✓	✓	✓	✓	✓			
	2	✓	✓	✓	✓	✓			
	3	✓	✓	✓	✓	✓			
	4	✓	✓	✓	✓	✓			
	5	✓	✓	✓	✓	✓			
	6	✓	✓	✓	✓	✓			
	7		✓	✓	✓	✓			
	8		✓	✓	✓	-			
	9		✓	✓	✓	-			
	10		✓	✓	✓	-			
	11		✓	✓	✓	-			
	12		✓	✓	✓	-			
	13		✓	✓	✓	-			
	14		✓	✓	✓	-			
	15		✓	✓	✓	-			
	16		✓	✓	✓	-			
	17		✓	✓	✓	-			
	18					O	=		
	19					O	=		
	20					O	=		
	21					O	=		
	22					O	=		
	23					O	=		
	24					O	=		
	25					O	=		
	26					✓			
	27					✓			
	28					✓			
	29					✓			
	30					✓			
	31					✓			
	32					✓			
	33					✓			
	34					✓			
	35					✓			

Search Notes 	Application/Control No. 11502921	Applicant(s)/Patent Under Reexamination DUAN, XIAOQIN
	Examiner BINH K TIEU	Art Unit 2614

SEARCHED			
Class	Subclass	Date	Examiner
379	111, 114.01, 114.03, 114.05, 114.12, 115.01, 121.01, 124	11/05/2009	BKT
370	356-360, 401	11/05/2009	BKT
UPDATED	SEARCHES	03/20/2010	BKT
455	405-408	03/20/2010	BKT
UPDATED	SEARCHES	07/04/2010	BKT
UPDATED	SEARCHES	12/05/2010	BKT
UPDATED	SEARCHES	02/23/2011	BKT

SEARCH NOTES		
Search Notes	Date	Examiner
WEST DATABASES TERMS SEARCHES	11/05/2009	BKT
WEST DATABASES TERMS SEARCHES	03/19/2010	BKT
WEST DATABASES TERMS SEARCHES	07/04/2010	BKT
WEST DATABASES TERMS SEARCHES	12/05/2010	BKT

INTERFERENCE SEARCH			
Class	Subclass	Date	Examiner

--	--

IN THE UNITED STATES PATENT AND TRADEMARK OFFICE

In re Application of:)	
)	Group Art Unit: 2614
Xiaoqin DUAN)	
)	Examiner: Tieu, Binh Kien
Application No.: 11/502,921)	
)	Confirmation No: 9151
Filed: August 11, 2006)	
)	
For: METHOD FOR CONTROLLING CHARGING)	
OF PACKET DATA SERVICE)	

Dear Sir:

AMENDMENT

In response to the Office Action dated December 8, 2010, applicant submits the following amendments and remarks. Applicant respectfully requests that the Examiner withdraw the rejections of claims and grant allowance of this Application in view of the following amendments and remarks.

Amendments to the Claims are reflected in the listing of claims which begins on page 2 of this paper.

Remarks begin on page 8 of this paper.

AMENDMENTS TO THE CLAIMS

Please amend the claims, as indicated below. This listing of claims will replace all prior versions, and listings, of claims in the application.

Listing of Claims:

1. (Currently amended) A method for controlling [[the]] charging of packet data service, comprising:

 monitoring, by a Traffic Plane Function (TPF), an event trigger provided by a Charging Rule Function (CRF); and

 sending, by the TPF, a charging rule request to the CRF to request a corresponding charging rule, if the event trigger is met.

2. (Previously presented) The method according to Claim 1, wherein the event trigger is set by the CRF, and includes a bearer modification event.

3. (Previously presented) The method according to Claim 2, further comprising:

 storing, by the TPF, the event trigger provided by the CRF.

4. (Previously presented) The method according to Claim 1, wherein the charging rule request sent from the TPF to the CRF comprises an event identifier indicating the event trigger.

5. (Previously presented) The method according to Claim 4, wherein the CRF responds to the charging rule request by providing a charging rule in a charging rule provision procedure according to the event trigger.

6. (Previously presented) The method according to Claim 2, wherein the event trigger and a provision charging rule are provided by the CRF to the TPF, and the provision charging rule is set by the CRF according to relevant information stored in the CRF, or charging-relevant input information provided by the TPF, the charging-relevant input information including at least one of information related with a subscriber and a UE, bearer characteristics information, and network information.

7. (Previously presented) The method according to Claim 1, wherein the event trigger is set by the CRF, and includes at least one of a change of a Serving GPRS Support Node (SGSN), a change of a Public Land Mobile Network (PLMN), a change of a Radio Access Technology (RAT) type, a change of a Traffic Flow Template (TFT), and a change of Quality of Service (QoS).

8-17 (Canceled)

18. (Currently amended) ~~[[The]]~~ A method according to Claim 1 for controlling charging of packet data service, further comprising:

monitoring, by a Traffic Plane Function (TPF), an event trigger provided by a Charging Rule Function (CRF);

sending, by the TPF, a charging rule request to the CRF , if the event trigger is met;
receiving, by the TPF, a charging rule from the CRF in a charging rule provision
procedure; and
taking, by the TPF, statistics of charging information according to the received
charging rule.

19. (Previously presented) The method according to Claim 18, further comprising:
sending, by the TPF, the statistics to a Credit Control Function (CCF) in an Online
Charging System (OCS); or
sending, by the TPF, the statistics to a Charging Gateway Function (CGF) and a
Charging Collection Function (CCF) in an offline charging system.

20. (Previously presented) The method according to Claim 19, wherein the TPF is a
Gateway General Packet Radio Service (GPRS) Support Node (GGSN) in a GPRS.

21. (Previously presented) The method according to Claim 19, further comprising:
receiving, by the TPF, a Modify Bearer Service Request from a User Equipment (UE);
after receiving the Modify Bearer Service Request, the TPF performs the monitoring step.

22. (Currently amended) ~~The TPF according to Claim 8~~ A Traffic Plane Function (TPF)
for controlling charging of packet data service, further comprising:
a monitoring unit, configured to monitor an event trigger provided by a Charging Rule
Function (CRF);

a sending unit, configured to send a charging rule request to the CRF if the event trigger is met;

a receiving unit, configured to receive a charging rule from the CRF in a charging rule provision procedure; and

a statistics taking unit, configured to take statistics of a charging information according to the Provision Charging Rule.

23. (Previously presented) The TPF according to Claim 22, further comprising:

a second sending unit, configured to send the statistics to a Credit Control Function (CCF) in an Online Charging System (OCS), or to send the statistics to a Charging Gateway Function (CGF) and a Charging Collection Function (CCF) in an offline charging system.

24. (Previously presented) The TPF according to Claim 23, wherein the TPF is a Gateway General Packet Radio Service (GPRS) Support Node (GGSN) in a GPRS.

25. (Previously presented) The TPF according to Claim 23, further comprising:

a second receiving unit, configured to receive a Modify Bearer Service Request from a User Equipment (UE).

26. (New) A Traffic Plane Function (TPF) for controlling charging of packet data service, wherein the TPF is configured to:

monitor an event trigger provided by a Charging Rule Function (CRF); and

send a charging rule request to the CRF to request a corresponding charging rule if the event trigger is met.

27. (New) The TPF according to claim 26, wherein the event trigger includes a bearer modification event.

28. (New) The TPF according to claim 27, wherein the bearer modification event comprises at least one of a change of a Serving GPRS Support Node (SGSN), a change of a Public Land Mobile Network (PLMN), a change of a Radio Access Technology (RAT) type, a change of a Traffic Flow Template (TFT), and a change of Quality of Service (QoS).

29. (New) The TPF according to Claim 28, wherein the TPF is further configured to store the event trigger provided by the CRF.

30. (New) The TPF according to Claim 26, wherein the charging rule request sent from the TPF to the CRF comprises an event identifier indicating the event trigger.

31. (New) The TPF according to Claim 30, wherein the CRF responds to the charging rule request by providing a charging rule in a charging rule provision procedure according to the event trigger.

32. (New) A Charging Rule Function (CRF) for controlling charging of packet data service, wherein the CRF is configured to:

- determine an event trigger;
- provide the event trigger to a Traffic Plane Function (TPF); and
- receive a charging rule request requesting a corresponding charging rule from the TPF if the event trigger is met.

33. (New) The CRF according to claim 32, wherein the event trigger and a provision charging rule are provided by the CRF to the TPF, and the provision charging rule is set by the CRF according to relevant information stored in the CRF, or charging-relevant input information provided by the TPF, the charging-relevant input information including at least one of information related with a subscriber and a UE, bearer characteristics information, and network information.

34. (New) The CRF according to claim 32, wherein the event trigger includes a bearer modification event.

35. (New) The CRF according to claim 34, wherein the bearer modification event comprises at least one of a change of a Serving GPRS Support Node (SGSN), a change of a Public Land Mobile Network (PLMN), a change of a Radio Access Technology (RAT) type, a change of a Traffic Flow Template (TFT), and a change of Quality of Service (QoS).

REMARKS

In the Office Action, the Examiner rejected claims 1-17 under 35 U.S.C. § 103(a) as being unpatentable over U.S. Pub No. 2003/0165222 A1 (“Syrjala”)¹ in view of U.S. Patent No. 7203301 B1 (“Mudd”); and objected to claims 18-25 as being dependent upon a rejected base claim but allowable if rewritten in independent form.

Claim 1 is amended for clarification. Claims 8-17 are canceled without prejudice or disclaimer of their subject matter. Claims 18 and 22 are rewritten in independent form according to the Examiner’s suggestion. New claims 26-35 are added. Upon entry of this Amendment, claims 1-7 and 18-35 will remain pending. Applicant respectfully traverses the rejection and objection for at least the following reasons.

Rejection of Claims 1-17 under 35 U.S.C. § 103(a):

Applicant respectfully traverses the rejection of claims 1-17 under 35 U.S.C. § 103(a) as being unpatentable over Syrjala in view of Mudd.

Independent claim 1, as amended, recites a combination including, for example, “sending, by the TPF, a charging rule request to the CRF to request a corresponding charging rule, if the event trigger is met” (emphases added).

The Office alleged that “Syrjala . . . teaches . . . the access layer T with the CSCF and CSE_T performed as a . . . TPF” and “the CSE_A performed as a . . . CRF.” Office Action, p. 3. In addition, the Office alleged that “[t]he CSE_T then instruct the CSCF to send a message . . . to the CSE_A . . . as a charging rule request.” Office Action, p. 3. However, this allegation is not correct.

¹ At page 2, paragraph 3 of the Office Action, the Examiner cites Syrjala et al. as U.S. Patent No. 7,017,050. However, the ‘050 patent issued to Dalton et al. Applicant assumes the Examiner intended to cite U.S. Patent Application Publication No. 2003/0165222 of Syrjala et al., which is consistent with the Examiner’s remarks regarding the rejection.

Specifically, Syrjala teaches that “the CSE_T sends, in a message 2-5, the tariff of the telephony operator and instructs the CSCF that the tariff of the telephony operator is to be transmitted to the CSE_A.” Syrjala, par. [0038], *see* also FIG. 2. In view of this, in Syrjala, what is sent to the CSE_A is merely a “tariff of the telephony operator,” which does not “request a corresponding charging rule,” as recited in claim 1 (emphasis added), and is thus different from the claimed “charging rule request.” For at least this reason, Syrjala fails to teach or suggest “sending, by the TPF, a charging rule request to the CRF to request a corresponding charging rule, if the event trigger is met,” as recited in claim 1. Mudd also fails to teach or suggest at least this element, and thus does not compensate for this deficiency of Syrjala.

Moreover, independent claim 1 further recites “monitoring . . . an event trigger provided by a Charging Rule Function.” The Office conceded that Syrjala fails to teach this element, but then relied on Mudd to cure this deficiency of Syrjala. *See* Office Action, pp. 3-4. However, this is not correct.

Particularly, the Office asserted that Mudd teaches “[i]f the call is determined that the first selected criteria (read on the trigger) is met, a query is created.” Office Action, p. 4. However, Applicant respectfully notes that there is no teaching or suggestion in Mudd that the first selected criteria or the determination of whether such criteria is met is provided by a Charging Rule Function. For at least this reason, Mudd also fails to teach or suggest “monitoring . . . an event trigger provided by a Charging Rule Function,” as recited in claim 1, and thus does not compensate for the deficiency of Syrjala.

In view of the above, no reason has been articulated as to why claim 1 is obvious. Thus, a *prima facie* case of obviousness has not been established. Claim 1 is therefore allowable.

Claims 2-7 are also allowable at least by virtue of their dependence from claim 1.

Claims 8-17 are canceled, rendering their rejection moot.

Therefore, Applicant respectfully requests that the Examiner reconsider and withdraw the rejection of claims 1-7 under 35 U.S.C. § 103(a).

Objection to Claims 18-25:

Claims 18 and 22 are rewritten in independent form as suggested by the Examiner. Therefore, claims 18 and 22, as well as claims 19-21 and 23-25 dependent therefrom, are allowable.

New Claims:

Newly added independent claims 26 and 32, although different in scope from independent claim 1, recite elements similar to those discussed with respect to claim 1, and are thus allowable for at least the reasons similar to those discussed above with respect to claim 1. Newly added dependent claims 27-31 and 33-35 are also allowable at least by virtue of their dependence from one of base claims 26 and 32.

Conclusion

In view of the foregoing, Applicant requests reconsideration and withdrawal of the rejection. The pending claims are in condition for allowance. Accordingly, Applicant requests a favorable action.

If there are any remaining issues or misunderstandings, Applicant requests that the Examiner telephone the undersigned representative to discuss them.

Please grant any extensions of time required to enter this response and charge any additional required fees to our deposit account 06-0916.

Respectfully submitted,

FINNEGAN, HENDERSON, FARABOW,
GARRETT & DUNNER, L.L.P.

Dated: February 10, 2011

By: 
Richard V. Burgujian
Reg. No. 31,744
(202) 408-4000

Electronic Acknowledgement Receipt

EFS ID:	9418758
Application Number:	11502921
International Application Number:	
Confirmation Number:	9151
Title of Invention:	Method for controlling charging of packet data service
First Named Inventor/Applicant Name:	Xiaoqin Duan
Customer Number:	97664
Filer:	Weiguo Chen/JANET RA
Filer Authorized By:	Weiguo Chen
Attorney Docket Number:	11005.0219-00000
Receipt Date:	10-FEB-2011
Filing Date:	11-AUG-2006
Time Stamp:	15:09:56
Application Type:	Utility under 35 USC 111(a)

Payment information:

Submitted with Payment	no
------------------------	----

File Listing:

Document Number	Document Description	File Name	File Size(Bytes)/ Message Digest	Multi Part /.zip	Pages (if appl.)
1		Amendment.pdf	361102 <small>f709c7f95d4ac075c527cf96315f18a64c5ee f68</small>	yes	11

Multipart Description/PDF files in .zip description		
Document Description	Start	End
Amendment/Req. Reconsideration-After Non-Final Reject	1	1
Claims	2	7
Applicant Arguments/Remarks Made in an Amendment	8	11

Warnings:

Information:

Total Files Size (in bytes):	361102
-------------------------------------	--------

This Acknowledgement Receipt evidences receipt on the noted date by the USPTO of the indicated documents, characterized by the applicant, and including page counts, where applicable. It serves as evidence of receipt similar to a Post Card, as described in MPEP 503.

New Applications Under 35 U.S.C. 111

If a new application is being filed and the application includes the necessary components for a filing date (see 37 CFR 1.53(b)-(d) and MPEP 506), a Filing Receipt (37 CFR 1.54) will be issued in due course and the date shown on this Acknowledgement Receipt will establish the filing date of the application.

National Stage of an International Application under 35 U.S.C. 371

If a timely submission to enter the national stage of an international application is compliant with the conditions of 35 U.S.C. 371 and other applicable requirements a Form PCT/DO/EO/903 indicating acceptance of the application as a national stage submission under 35 U.S.C. 371 will be issued in addition to the Filing Receipt, in due course.

New International Application Filed with the USPTO as a Receiving Office

If a new international application is being filed and the international application includes the necessary components for an international filing date (see PCT Article 11 and MPEP 1810), a Notification of the International Application Number and of the International Filing Date (Form PCT/RO/105) will be issued in due course, subject to prescriptions concerning national security, and the date shown on this Acknowledgement Receipt will establish the international filing date of the application.

Under the Paperwork Reduction Act of 1995, no persons are required to respond to a collection of information unless it displays a valid OMB control number.

PATENT APPLICATION FEE DETERMINATION RECORD Substitute for Form PTO-875					Application or Docket Number 11/502,921		Filing Date 08/11/2006		<input type="checkbox"/> To be Mailed	
APPLICATION AS FILED – PART I										
(Column 1)			(Column 2)			SMALL ENTITY <input type="checkbox"/>		OR		OTHER THAN SMALL ENTITY
FOR	NUMBER FILED	NUMBER EXTRA	RATE (\$)	FEE (\$)		RATE (\$)	FEE (\$)			
<input type="checkbox"/> BASIC FEE (37 CFR 1.16(a), (b), or (c))	N/A	N/A	N/A			N/A				
<input type="checkbox"/> SEARCH FEE (37 CFR 1.16(k), (i), or (m))	N/A	N/A	N/A			N/A				
<input type="checkbox"/> EXAMINATION FEE (37 CFR 1.16(o), (p), or (q))	N/A	N/A	N/A			N/A				
TOTAL CLAIMS (37 CFR 1.16(i))	minus 20 =	*	X \$ =		OR	X \$ =				
INDEPENDENT CLAIMS (37 CFR 1.16(h))	minus 3 =	*	X \$ =			X \$ =				
<input type="checkbox"/> APPLICATION SIZE FEE (37 CFR 1.16(s))	If the specification and drawings exceed 100 sheets of paper, the application size fee due is \$250 (\$125 for small entity) for each additional 50 sheets or fraction thereof. See 35 U.S.C. 41(a)(1)(G) and 37 CFR 1.16(s).									
<input type="checkbox"/> MULTIPLE DEPENDENT CLAIM PRESENT (37 CFR 1.16(j))										
* If the difference in column 1 is less than zero, enter "0" in column 2.										
TOTAL			TOTAL			TOTAL		TOTAL		
APPLICATION AS AMENDED – PART II										
(Column 1)			(Column 2)			SMALL ENTITY		OR		OTHER THAN SMALL ENTITY
AMENDMENT	02/10/2011	CLAIMS REMAINING AFTER AMENDMENT		HIGHEST NUMBER PREVIOUSLY PAID FOR	PRESENT EXTRA	RATE (\$)	ADDITIONAL FEE (\$)		RATE (\$)	ADDITIONAL FEE (\$)
	Total (37 CFR 1.16(i))	* 25	Minus	** 25	= 0	X \$ =		OR	X \$2=	0
	Independent (37 CFR 1.16(h))	* 5	Minus	***3	= 2	X \$ =		OR	X \$220=	440
	<input type="checkbox"/> Application Size Fee (37 CFR 1.16(s))									
	<input type="checkbox"/> FIRST PRESENTATION OF MULTIPLE DEPENDENT CLAIM (37 CFR 1.16(j))									
TOTAL ADD'L FEE			TOTAL ADD'L FEE			TOTAL ADD'L FEE		TOTAL ADD'L FEE		440
AMENDMENT		CLAIMS REMAINING AFTER AMENDMENT		HIGHEST NUMBER PREVIOUSLY PAID FOR	PRESENT EXTRA	RATE (\$)	ADDITIONAL FEE (\$)		RATE (\$)	ADDITIONAL FEE (\$)
	Total (37 CFR 1.16(i))	*	Minus	**	=	X \$ =		OR	X \$ =	
	Independent (37 CFR 1.16(h))	*	Minus	***	=	X \$ =		OR	X \$ =	
	<input type="checkbox"/> Application Size Fee (37 CFR 1.16(s))									
	<input type="checkbox"/> FIRST PRESENTATION OF MULTIPLE DEPENDENT CLAIM (37 CFR 1.16(j))									
TOTAL ADD'L FEE			TOTAL ADD'L FEE			TOTAL ADD'L FEE		TOTAL ADD'L FEE		
* If the entry in column 1 is less than the entry in column 2, write "0" in column 3.										
** If the "Highest Number Previously Paid For" IN THIS SPACE is less than 20, enter "20".										
*** If the "Highest Number Previously Paid For" IN THIS SPACE is less than 3, enter "3".										
The "Highest Number Previously Paid For" (Total or Independent) is the highest number found in the appropriate box in column 1.										

Legal Instrument Examiner:
/Trina Steptoe/

This collection of information is required by 37 CFR 1.16. The information is required to obtain or retain a benefit by the public which is to file (and by the USPTO to process) an application. Confidentiality is governed by 35 U.S.C. 122 and 37 CFR 1.14. This collection is estimated to take 12 minutes to complete, including gathering, preparing, and submitting the completed application form to the USPTO. Time will vary depending upon the individual case. Any comments on the amount of time you require to complete this form and/or suggestions for reducing this burden, should be sent to the Chief Information Officer, U.S. Patent and Trademark Office, U.S. Department of Commerce, P.O. Box 1450, Alexandria, VA 22313-1450. DO NOT SEND FEES OR COMPLETED FORMS TO THIS ADDRESS. **SEND TO: Commissioner for Patents, P.O. Box 1450, Alexandria, VA 22313-1450.**

If you need assistance in completing the form, call 1-800-PTO-9199 and select option 2.

Document code: WFEE

United States Patent and Trademark Office
Sales Receipt for Accounting Date: 02/16/2011

TSTEPTOE	SALE	#00000001	Mailroom Dt:	02/10/2011	060916	11502921
		01	FC : 1201	440.00	DA	



UNITED STATES PATENT AND TRADEMARK OFFICE

UNITED STATES DEPARTMENT OF COMMERCE
United States Patent and Trademark Office
Address: COMMISSIONER FOR PATENTS
P.O. Box 1450
Alexandria, Virginia 22313-1450
www.uspto.gov

APPLICATION NO.	FILING DATE	FIRST NAMED INVENTOR	ATTORNEY DOCKET NO.	CONFIRMATION NO.
11/502,921	08/11/2006	Xiaoqin Duan	11005.0219-00000	9151
97664	7590	12/08/2010	EXAMINER	
Huawei Technologies Co., Ltd./Finnegan 901 New York Avenue NW Washington, DC 20001			TIEU, BINH KIEN	
			ART UNIT	PAPER NUMBER
			2614	
			MAIL DATE	DELIVERY MODE
			12/08/2010	PAPER

Please find below and/or attached an Office communication concerning this application or proceeding.

The time period for reply, if any, is set in the attached communication.

Office Action Summary	Application No. 11/502,921	Applicant(s) DUAN, XIAOQIN	
	Examiner BINH K. TIEU	Art Unit 2614	

-- The MAILING DATE of this communication appears on the cover sheet with the correspondence address --
Period for Reply

A SHORTENED STATUTORY PERIOD FOR REPLY IS SET TO EXPIRE 3 MONTH(S) OR THIRTY (30) DAYS, WHICHEVER IS LONGER, FROM THE MAILING DATE OF THIS COMMUNICATION.

- Extensions of time may be available under the provisions of 37 CFR 1.136(a). In no event, however, may a reply be timely filed after SIX (6) MONTHS from the mailing date of this communication.
- If NO period for reply is specified above, the maximum statutory period will apply and will expire SIX (6) MONTHS from the mailing date of this communication.
- Failure to reply within the set or extended period for reply will, by statute, cause the application to become ABANDONED (35 U.S.C. § 133). Any reply received by the Office later than three months after the mailing date of this communication, even if timely filed, may reduce any earned patent term adjustment. See 37 CFR 1.704(b).

Status

- 1) Responsive to communication(s) filed on 22 October 2010.
- 2a) This action is **FINAL**. 2b) This action is non-final.
- 3) Since this application is in condition for allowance except for formal matters, prosecution as to the merits is closed in accordance with the practice under *Ex parte Quayle*, 1935 C.D. 11, 453 O.G. 213.

Disposition of Claims

- 4) Claim(s) 1-25 is/are pending in the application.
 - 4a) Of the above claim(s) _____ is/are withdrawn from consideration.
- 5) Claim(s) _____ is/are allowed.
- 6) Claim(s) 1-17 is/are rejected.
- 7) Claim(s) 18-25 is/are objected to.
- 8) Claim(s) _____ are subject to restriction and/or election requirement.

Application Papers

- 9) The specification is objected to by the Examiner.
- 10) The drawing(s) filed on _____ is/are: a) accepted or b) objected to by the Examiner.
 Applicant may not request that any objection to the drawing(s) be held in abeyance. See 37 CFR 1.85(a).
 Replacement drawing sheet(s) including the correction is required if the drawing(s) is objected to. See 37 CFR 1.121(d).
- 11) The oath or declaration is objected to by the Examiner. Note the attached Office Action or form PTO-152.

Priority under 35 U.S.C. § 119

- 12) Acknowledgment is made of a claim for foreign priority under 35 U.S.C. § 119(a)-(d) or (f).
 - a) All b) Some * c) None of:
 - 1. Certified copies of the priority documents have been received.
 - 2. Certified copies of the priority documents have been received in Application No. _____.
 - 3. Copies of the certified copies of the priority documents have been received in this National Stage application from the International Bureau (PCT Rule 17.2(a)).

* See the attached detailed Office action for a list of the certified copies not received.

Attachment(s)

- 1) Notice of References Cited (PTO-892)
- 2) Notice of Draftsperson's Patent Drawing Review (PTO-948)
- 3) Information Disclosure Statement(s) (PTO/SB/08)
 Paper No(s)/Mail Date _____.
- 4) Interview Summary (PTO-413)
 Paper No(s)/Mail Date. _____.
- 5) Notice of Informal Patent Application
- 6) Other: _____.

DETAILED ACTION

Response to Amendment

1. The Applicant's amendment filed on 09/28/2010 was entered. As the results, no claims were amended or canceled. New claims 18-25 were added. At this time, claims 1-25 are pending in this application.

Claim Rejections - 35 USC § 103

2. The following is a quotation of 35 U.S.C. 103(a) which forms the basis for all obviousness rejections set forth in this Office action:

(a) A patent may not be obtained though the invention is not identically disclosed or described as set forth in section 102 of this title, if the differences between the subject matter sought to be patented and the prior art are such that the subject matter as a whole would have been obvious at the time the invention was made to a person having ordinary skill in the art to which said subject matter pertains. Patentability shall not be negated by the manner in which the invention was made.

3. Claims 1-17 are rejected under 35 U.S.C. 103(a) as being unpatentable over Syrjala et al. (US. Pat. #: 7,017,050, as cited in the previous Office Action) in view of Mudd et al. (US. Pat. #: 7,203,301).

Regarding claims 1 and 8, Syrjala et al. ("Syrjala") teaches a universal mobile communications system (UMTS) system 1 comprising an access layer A and a Telephony layer T as shown separated in figure 1. The telephony layer T comprises IP network, a call state control function (CSCF), a media gateway control function (MGCF) and an execution environment (CSE-T) which corresponding to a service control point in an intelligent network. The access layer A comprises a UMTS terrestrial radio access network (UTRAN) and a core network (CN). The CN comprises at least support nodes SGSN and GGSN. When user equipment (UE) requests a service by transmitting a

connection setup request to the CSCF via the SGSN and GGSN, the reception of the call set-up request results in encountering, at the CSCF, a trigger as (Detection Point) to initiate the service, which cause the CSCF to transmit a request for instructions to the service control function CSE_T. At the CSE_T, information about a prepaid subscription, and the service control function CSE_A is responsible for the prepaid account of the prepaid subscription is determined and located in a database of the CSE_T, i.e., matching to the telephone number of the caller (***see paragraph [0037], it should be understood that the access layer T with the CSCF and CSE_T performed as a Traffic Plane Function (TPF)***). The CSE_T then instructs the CSCF to send a message, included tariff of the telephony operator and all special events, to the CSE_A located in the access layer A as a charging rule request. Thus, ***the CSE_A performed as a Charging Rule Function (CRF), i.e., to apply a tariff to be charged to the prepaid account in according to a billing-related contract (see paragraphs [0038] and [0039]; or the access operator tariff information is requested from the CSE_A, paragraph [0043]***.

It should be noticed from the Applicant's remarks, filed on 09/28/2010 that Syrjala fails to clearly teach the features of "...**an event trigger provided by a Charging Rule Function (CRF)**..." However, Mudd et al. ("Mudd") teaches a system and method for call treatment to provide, inter alia, information to a billing entity for payment (see the Abstract). Mudd further teaches that the system comprises a call intelligence 150 being coupled to signaling network 140 to receive information therefrom and/or to provide information thereto, as shown in figure 5 (see col.6, lines 55-57). Mudd further teaches

a basis Call Model to identify various points in call (PICs) in order to events which may occur at certain PICs called detection points (DPs) (col.3, lines 35-65). In operation, when a call is initiated, one of the DPs associated with the call may be utilized to recognize an aspect of such particular call being attempted or implemented (see col.8, line 64 – col.9, line 26). The call is determined by using call intelligent processing and other local information previously provided by the call intelligent 150 and stored in a database at a device of the signaling network 140 (read on the **TPF**) (see col.9, lines 33-39). If the call is determined that the first selected criteria (read on the trigger) is met, a query is created with included information to be sent to the call intelligence 150 (see col.9, line 66 through col.10, line 11) for a purpose of scoring a risk associated with the call, collecting billing information, preventing the call being setup, etc.

Therefore, it would have been obvious to one of ordinary skill in the art at the time the invention was made to incorporate the use of the features of “...**an event trigger provided by a Charging Rule Function (CRF)**...”, as taught by Mudd, into view of Syrjala in order to securely collect billing information and further processing the call.

Regarding claims 2, 6, 9-10, and 13, Syrjala further teaches the telephone number of caller is used as “trigger” to detect the prepaid subscription of an account wherein the account information about services included, inter alia, use of basic telephone, different data bearers, etc. are set by the service provider of the CSE_A (see paragraphs [0037] and [0021]).

Regarding claims 3, 5 and 11, Syrjala further teaches limitations of the claims such as the feature of setting “arming of detection points” in the CSCF in paragraph [0039].

Regarding claims 4 and 12, Syrjala further teaches the C_ID as limitations of the claims in paragraphs [0053] and [0054].

Regarding claim 7, Syrjala further teaches the limitations of the claim in the figure 1, paragraphs [0021] and [0039].

Regarding claim 14, Syrjala teaches a Charging Rule Function (CRF) for controlling charging of packet data service, comprising:

a determining unit, configured to determine an event trigger (*i.e., the SGSN and CSCF encountering a subscriber-specific event (see paragraphs [0035] and [0037])*); and

a providing unit, configured to provide the event trigger to a Traffic Plane Function (TPF) (*i.e. the CSCF and CSE_T sending a message included tariff of the telephony operator and all special events, to the CSE_A located in the access layer A (see paragraphs [0038] and [0039]; or the access operator tariff information is requested from the CSE_A, paragraph [0043])*).

It should be noticed from the Applicant's remarks, filed on 09/28/2010 that Syrjala fails to clearly teach the features of “...**an event trigger provided by a Charging Rule Function (CRF)**...” However, Mudd et al. (“Mudd”) teaches a system and method for call treatment to provide, inter alia, information to a billing entity for payment (see the Abstract). Mudd further teaches that the system comprises a call intelligence 150 being

coupled to signaling network 140 to receive information therefrom and/or to provide information thereto, as shown in figure 5 (see col.6, lines 55-57). Mudd further teaches a basis Call Model to identify various points in call (PICs) in order to events which may occur at certain PICs called detection points (DPs) (col.3, lines 35-65). In operation, when a call is initiated, one of the DPs associated with the call may be utilized to recognize an aspect of such particular call being attempted or implemented (see col.8, line 64 – col.9, line 26). The call is determined by using call intelligent processing and other local information previously provided by the call intelligent 150 and stored in a database at a device of the signaling network 140 (read on the **TPF**) (see col.9, lines 33-39). If the call is determined that the first selected criteria (read on the trigger) is met, a query is created with included information to be sent to the call intelligence 150 (see col.9, line 66 through col.10, line 11) for a purpose of scoring a risk associated with the call, collecting billing information, preventing the call being setup, etc.

Therefore, it would have been obvious to one of ordinary skill in the art at the time the invention was made to incorporate the use of the features of “...**an event trigger provided by a Charging Rule Function (CRF)**...”, as taught by Mudd, into view of Syrjala in order to securely collect billing information and further processing the call.

Regarding claim 15, Syrjala further teaches the feature of setting “arming of detection points” in the CSCF in paragraph [0039].

Regarding claim 16-17, Syrjala further teaches the telephone number of caller is used as “trigger” to detect the prepaid subscription of an account wherein the account

Art Unit: 2614

information about services included, inter alia, use of basic telephone, different data bearers, etc. are set by the service provider of the CSE_A (see paragraphs [0037] and [0021]).

Allowable Subject Matter

4. Claims 18-25 are objected to as being dependent upon a rejected base claim, but would be allowable if rewritten in independent form including all of the limitations of the base claim and any intervening claims.

5. Any inquiry concerning this communication or earlier communications from the examiner should be directed to Binh K. Tieu whose telephone number is (571) 272-7510 and E-mail address: BINH.TIEU@USPTO.GOV.

If attempts to reach the examiner by telephone are unsuccessful, the examiner's supervisor, Mr. Curtis Kuntz, can be reached on (571) 272-7499 and **IF PAPER HAS BEEN MISSED FROM THIS OFFICIAL ACTION PACKAGE, PLEASE CALL CUSTOMER SERVICE FOR THE SUBSTITUTIONS OR COPIES.**

Any response to this action should be mailed to:
Commissioner of Patents and Trademarks
Washington, D.C. 20231
Or faxed to: (571) 273-8300
Hand Carry Deliveries to:
Customer Service Window
(Randolph Building)
401 Dulany Street
Alexandria, VA 22314

Information regarding the status of an application may be obtained from the Patent Application Information Retrieval (PAIR) system. Status information for published applications may be obtained from either Private PAIR or Public PAIR. Status information for unpublished applications is available through Private PAIR only.

Application/Control Number: 11/502,921

Page 8

Art Unit: 2614

For more information about the FAIR system, see <http://pair-direct.uspto.gov>. If you have any questions on access to the Private PAIR system, contact the Electronic Business Center (EBC) at 866-217-9197 (toll-free).

/BINH K. TIEU/
Primary Examiner
Technology Division 2614

Date: December 2010

Notice of References Cited	Application/Control No. 11/502,921	Applicant(s)/Patent Under Reexamination DUAN, XIAOQIN	
	Examiner BINH K. TIEU	Art Unit 2614	Page 1 of 1

U.S. PATENT DOCUMENTS

*	Document Number Country Code-Number-Kind Code	Date MM-YYYY	Name	Classification
*	A US-7,203,301	04-2007	Mudd et al.	379/220.01
	B US-			
	C US-			
	D US-			
	E US-			
	F US-			
	G US-			
	H US-			
	I US-			
	J US-			
	K US-			
	L US-			
	M US-			

FOREIGN PATENT DOCUMENTS

*	Document Number Country Code-Number-Kind Code	Date MM-YYYY	Country	Name	Classification
	N				
	O				
	P				
	Q				
	R				
	S				
	T				

NON-PATENT DOCUMENTS

*	Include as applicable: Author, Title Date, Publisher, Edition or Volume, Pertinent Pages)
	U
	V
	W
	X

*A copy of this reference is not being furnished with this Office action. (See MPEP § 707.05(a).)
Dates in MM-YYYY format are publication dates. Classifications may be US or foreign.

Index of Claims 	Application/Control No. 11502921	Applicant(s)/Patent Under Reexamination DUAN, XIAOQIN
	Examiner BINH K TIEU	Art Unit 2614

✓	Rejected
=	Allowed

-	Cancelled
÷	Restricted

N	Non-Elected
I	Interference

A	Appeal
O	Objected

Claims renumbered in the same order as presented by applicant
 CPA
 T.D.
 R.1.47

CLAIM		DATE							
Final	Original	11/04/2009	03/20/2010	07/05/2010	12/05/2010				
	1	✓	✓	✓	✓				
	2	✓	✓	✓	✓				
	3	✓	✓	✓	✓				
	4	✓	✓	✓	✓				
	5	✓	✓	✓	✓				
	6	✓	✓	✓	✓				
	7		✓	✓	✓				
	8		✓	✓	✓				
	9		✓	✓	✓				
	10		✓	✓	✓				
	11		✓	✓	✓				
	12		✓	✓	✓				
	13		✓	✓	✓				
	14		✓	✓	✓				
	15		✓	✓	✓				
	16		✓	✓	✓				
	17		✓	✓	✓				
	18				○				
	19				○				
	20				○				
	21				○				
	22				○				
	23				○				
	24				○				
	25				○				

Search Notes 	Application/Control No. 11502921	Applicant(s)/Patent Under Reexamination DUAN, XIAOQIN
	Examiner BINH K TIEU	Art Unit 2614

SEARCHED			
Class	Subclass	Date	Examiner
379	111, 114.01, 114.03, 114.05, 114.12, 115.01, 121.01, 124	11/05/2009	BKT
370	356-360, 401	11/05/2009	BKT
UPDATED	SEARCHES	03/20/2010	BKT
455	405-408	03/20/2010	BKT
UPDATED	SEARCHES	07/04/2010	BKT
UPDATED	SEARCHES	12/05/2010	BKT

SEARCH NOTES		
Search Notes	Date	Examiner
WEST DATABASES TERMS SEARCHES	11/05/2009	BKT
WEST DATABASES TERMS SEARCHES	03/19/2010	BKT
WEST DATABASES TERMS SEARCHES	07/04/2010	BKT
WEST DATABASES TERMS SEARCHES	12/05/2010	BKT

INTERFERENCE SEARCH			
Class	Subclass	Date	Examiner

--	--

WEST Search History for Application 11502921

Creation Date: 2010120515:20

Prior Art Searches

Query	DB	Op.	Plur.	Thes.	Date
(trigger or criteria) with met	PGPB, USPT, USOC, EPAB, JPAB, DWPI, TDBD	ADJ	YES		12-05-2010
379/111-140.ccls.	PGPB, USPT, USOC, EPAB, JPAB, DWPI, TDBD	ADJ	YES		12-05-2010
(379/111-140.ccls.) and ((trigger or criteria) with met)	PGPB, USPT, USOC, EPAB, JPAB, DWPI, TDBD	ADJ	YES		12-05-2010
statistic with charg\$3 information	PGPB, USPT, USOC, EPAB, JPAB, DWPI, TDBD	ADJ	YES		12-05-2010
(online or on-line) charg\$3 system	PGPB, USPT, USOC, EPAB, JPAB, DWPI, TDBD	ADJ	YES		12-05-2010
((online or on-line) charg\$3 system) and (statistic with charg\$3 information)	PGPB, USPT, USOC, EPAB, JPAB, DWPI, TDBD	ADJ	YES		12-05-2010
credit control function	PGPB, USPT, USOC, EPAB, JPAB, DWPI, TDBD	ADJ	YES		12-05-2010
(credit control function) and ((online or on-line) charg\$3 system and statistic with charg\$3 information)	PGPB, USPT, USOC, EPAB, JPAB, DWPI, TDBD	ADJ	YES		12-05-2010
scp with (credit control function)	PGPB, USPT, USOC, EPAB, JPAB, DWPI, TDBD	ADJ	YES		12-05-2010

(scp with credit control function) not (credit control function and (online or on-line) charg\$3 system and statistic with charg\$3 information)	PGPB, USPT, USOC, EPAB, JPAB, DWPI, TDBD	ADJ	YES		12-05-2010
scp with ccf	PGPB, USPT, USOC, EPAB, JPAB, DWPI, TDBD	ADJ	YES		12-05-2010
(scp with ccf) not (scp with credit control function)	PGPB, USPT, USOC, EPAB, JPAB, DWPI, TDBD	ADJ	YES		12-05-2010
(scp with ccf not scp with credit control function) and (statistic with charg\$3 information)	PGPB, USPT, USOC, EPAB, JPAB, DWPI, TDBD	ADJ	YES		12-05-2010
tpf and (scp with ccf not scp with credit control function)	PGPB, USPT, USOC, EPAB, JPAB, DWPI, TDBD	ADJ	YES		12-05-2010
statistic and (scp with ccf not scp with credit control function)	PGPB, USPT, USOC, EPAB, JPAB, DWPI, TDBD	ADJ	YES		12-05-2010



JTW

PATENT
Attorney Docket No. 11005.0219-00000
Huawei Ref. No. 0410606US

IN THE UNITED STATES PATENT AND TRADEMARK OFFICE

In re Application of:)	
)	Group Art Unit: 2614
Xiaoqin DUAN)	
)	Examiner: Tieu, Binh Kien
Application No.: 11/502,921)	
)	Confirmation No.: 9151
Filed: August 11, 2006)	
)	
For: METHOD FOR CONTROLLING CHARGING)	Mail Stop Amendment
OF PACKET DATA SERVICE)	

Commissioner for Patents
P.O. Box 1450
Alexandria, VA 22313-1450

Sir:

AMENDMENT

In response to the Office Action dated July 13, 2010, please amend the above-identified application as follows.

Amendments to the Claims are reflected in the listing of claims which begins on page 2 of this paper.

Remarks begin on page 8 of this paper.

AMENDMENTS TO THE CLAIMS

Please amend the claims, as indicated below. This listing of claims will replace all prior versions, and listings, of claims in the application.

Listing of Claims:

1. (Previously presented) A method for controlling the charging of packet data service, comprising:
monitoring, by a Traffic Plane Function (TPF), an event trigger provided by a Charging Rule Function (CRF); and
sending, by the TPF, a charging rule request to the CRF, if the event trigger is met.

2. (Previously presented) The method according to Claim 1, wherein the event trigger is set by the CRF, and includes a bearer modification event.

3. (Previously presented) The method according to Claim 2, further comprising:
storing, by the TPF, the event trigger provided by the CRF.

4. (Previously presented) The method according to Claim 1, wherein the charging rule request sent from the TPF to the CRF comprises an event identifier indicating the event trigger.

5. (Previously presented) The method according to Claim 4, wherein the CRF responds to the charging rule request by providing a charging rule in a charging rule provision procedure according to the event trigger.

6. (Previously presented) The method according to Claim 2, wherein the event trigger and a provision charging rule are provided by the CRF to the TPF, and the provision charging rule is set by the CRF according to relevant information stored in the CRF, or charging-relevant input information provided by the TPF, the charging-relevant input information including at least one of information related with a subscriber and a UE, bearer characteristics information, and network information.

7. (Previously presented) The method according to Claim 1, wherein the event trigger is set by the CRF, and includes at least one of a change of a Serving GPRS Support Node (SGSN), a change of a Public Land Mobile Network (PLMN), a change of a Radio Access Technology (RAT) type, a change of a Traffic Flow Template (TFT), and a change of Quality of Service (QoS).

8. (Previously presented) A Traffic Plane Function (TPF) for controlling charging of packet data service, comprising:

a monitoring unit, configured to monitor an event trigger provided by a Charging Rule Function (CRF); and

a sending unit, configured to send a charging rule request to the CRF if the event trigger is met.

9. (Previously presented) The TPF according to claim 8, wherein the event trigger includes a bearer modification event.

10. (Previously presented) The TPF according to claim 9, wherein the bearer modification event comprises at least one of a change of a Serving GPRS Support Node (SGSN), a change of a Public Land Mobile Network (PLMN), a change of a Radio Access Technology (RAT) type, a change of a Traffic Flow Template (TFT), and a change of Quality of Service (QoS):

11. (Previously presented) The TPF according to Claim 10, further comprising a unit configured to store the event trigger provided by the CRF.

12. (Previously presented) The TPF according to Claim 8, wherein the charging rule request sent from the TPF to the CRF comprises an event identifier indicating the event trigger.

13. (Previously presented) The TPF according to Claim 12, wherein the CRF responds to the charging rule request by providing a charging rule in a charging rule provision procedure according to the event trigger.

14. (Previously presented) A Charging Rule Function (CRF) for controlling charging of packet data service, comprising:

a determining unit, configured to determine an event trigger; and
a providing unit, configured to provide the event trigger to a Traffic Plane Function (TPF).

15. (Previously presented) The CRF according to claim 14, wherein the event trigger and a provision charging rule are provided by the CRF to the TPF, and the provision charging rule is set by the CRF according to relevant information stored in the CRF, or charging-relevant input information provided by the TPF, the charging-relevant input information including at least one of information related with a subscriber and a UE, bearer characteristics information, and network information.

16. (Previously presented) The CRF according to claim 14, wherein the event trigger includes a bearer modification event.

17. (Previously presented) The CRF according to claim 16, wherein the bearer modification event comprises at least one of a change of a Serving GPRS Support Node (SGSN), a change of a Public Land Mobile Network (PLMN), a change of a Radio Access Technology (RAT) type, a change of a Traffic Flow Template (TFT), and a change of Quality of Service (QoS).

18. (New) The method according to Claim 1, further comprising:
receiving, by the TPF, a charging rule from the CRF in a charging rule provision procedure; and

taking, by the TPF, statistics of charging information according to the received charging rule.

19. (New) The method according to Claim 18, further comprising:

sending, by the TPF, the statistics to a Credit Control Function (CCF) in an Online Charging System (OCS); or

sending, by the TPF, the statistics to a Charging Gateway Function (CGF) and a Charging Collection Function (CCF) in an offline charging system.

20. (New) The method according to Claim 19, wherein the TPF is a Gateway General Packet Radio Service (GPRS) Support Node (GGSN) in a GPRS.

21. (New) The method according to Claim 19, further comprising:

receiving, by the TPF, a Modify Bearer Service Request from a User Equipment (UE); after receiving the Modify Bearer Service Request, the TPF performs the monitoring step.

22. (New) The TPF according to Claim 8, further comprising:

a receiving unit, configured to receive a charging rule from the CRF in a charging rule provision procedure; and

a statistics taking unit, configured to take statistics of a charging information according to the Provision Charging Rule.

23. (New) The TPF according to Claim 22, further comprising:

a second sending unit, configured to send the statistics to a Credit Control Function (CCF) in an Online Charging System (OCS), or to send the statistics to a Charging Gateway Function (CGF) and a Charging Collection Function (CCF) in an offline charging system.

24. (New) The TPF according to Claim 23, wherein the TPF is a Gateway General Packet Radio Service (GPRS) Support Node (GGSN) in a GPRS.

25. (New) The TPF according to Claim 23, further comprising:

a second receiving unit, configured to receive a Modify Bearer Service Request from a User Equipment (UE).

REMARKS

In the Office Action, the Examiner rejected claims 1-17 under 35 U.S.C. § 102(e) as being unpatentable over U.S. Pub No.2003/0165222A1 (“Syrjala”).

By this amendment, Applicant adds new claims 18-25. Support for new claims 18 and 22 may be found in Applicant’s specification at, e.g., para. [0079] and Figure 6. Support for new claims 19 and 23 may be found in Applicant’s specification at, e.g., para. [0018] - [0019] and Figure 2A- 2B. Support for new claims 20 and 24 may be found in Applicant’s specification at, e.g., para. [0022]. Support for new claims 21 and 25 may be found in Applicant’s specification at, e.g., para. [0089] and Figure 7. Upon entry of this Amendment, claims 1-25 remain pending. Applicant respectfully traverses the rejection for at least the following reasons.

Rejection of Claims 1-17 under 35 U.S.C. § 102(e):

Applicant respectfully traverses the rejection of claims 1-17 under 35 U.S.C. § 102(e) as being anticipated by Syrjala. In order to properly establish that Syrjala anticipates Applicant’s claimed invention under 35 U.S.C. § 102, each and every element of each of the claims in issue must be found, either expressly described or under principles of inherency, in that single reference. Furthermore, “[t]he identical invention must be shown in as complete detail as is contained in the ... claim.” See M.P.E.P. § 2131, quoting Richardson v. Suzuki Motor Co., 868 F.2d 1126, 1236, 9 U.S.P.Q.2d 1913, 1920 (Fed. Cir. 1989). Syrjala does not disclose each and every element of Applicant’s claimed invention.

Syrjala fails to teach or suggest each and every element recited in the claims. For example, Syrjala fails to teach or suggest at least “[a] method for controlling the charging of

packet data service, comprising: monitoring, by a Traffic Plane Function (TPF), an event trigger provided by a Charging Rule Function (CRF); and sending, by the TPF, a charging rule request to the CRF, if the event trigger is met,” as recited in independent claim 1 (emphasis added).

The Examiner alleged that “Syrjala [] teaches ... the access layer T with the CSCF and CSE_T performed as a . . . TPF” and “the CSE_A performed as a . . . CRF.” Office Action, p. 3. The Examiner also appeared to allege that the “Detection Point” of Syrjala corresponds to the claimed “event trigger.” *See* Office Action, p. 3. Without acquiescing to these allegations, Applicant respectfully submits that Syrjala does not teach or suggest “monitoring ... an event trigger provided by a Charging Rule Function (CRF),” as recited in claim 1 (emphasis added).

Applicant notes that the Office Action mischaracterizes Syrjala. Syrjala discloses that “[r]eception of the call setup request 2-1 results in encountering, at the CSCF, a trigger (Detection Point) to initiate the service. ... [T]he CSCF transmits a message 2-6 ... to the CSE_A. [T]he CSE_A transmits an instruction to the CSCF in a message 2-8A[, which] ... may also comprise other information related to the intelligent-network-like controlling, such as arming of detection points.” Syrjala, para. [0037]-[0039] (emphasis added). Thus, the CSE_A of Syrjala transmits the arming of detection points to the CSCF in a message 2-8A after the CSE_A received the message 2-6 from the CSCF, where message 2-6 is alleged by the Office Action as corresponding to the claimed “charging rule request.” That is, Syrjala merely discloses that the CSCF performs the encountering steps, but nevertheless does not disclose who provides the Detection Point. In fact, there is no teaching in Syrjala that the CSE_A provided the Detection Point as an event trigger.

In view of the above, Syrjala fails to teach “[a] method for controlling the charging of packet data service, comprising: monitoring, by a Traffic Plane Function (TPF), an event trigger provided by a Charging Rule Function (CRF); and sending, by the TPF, a charging rule request to the CRF, if the event trigger is met,” as recited in independent claim 1 (emphasis added).

For at least the above-noted reasons, Syrjala fails to disclose each and every element recited in claim 1, and hence, cannot anticipate claim 1. Claim 1 is allowable. The 35 U.S.C. § 102(e) rejection of claim 1 and, hence, dependent claims 2-7, is therefore improper and should be withdrawn.

Independent claims 8 and 14, although different in scope from claim 1 and from each other, recite elements similar to those as discussed with respect to claim 1 and are thus allowable for at least the reasons discussed above with respect to claim 1. Dependent claims 9-13 and 15-17 are also allowable at least by virtue of their dependence from one of base claims 8 and 14.

New Claims 18-25

Newly added claims 18-25 are also allowable at least by virtue of their dependence from claim 1 or 8, and also because they recite features not taught in the cited reference.

Conclusion

In view of the foregoing, Applicant requests reconsideration of the application and withdrawal of the rejection. Pending claims 1-25 are in condition for allowance. Accordingly, Applicant requests a favorable action.

If there are any remaining issues or misunderstandings, Applicant requests that the Examiner telephone the undersigned representative to discuss them.

Please grant any extensions of time required to enter this response and charge any additional required fees to our deposit account 06-0916.

Respectfully submitted,

FINNEGAN, HENDERSON, FARABOW,
GARRETT & DUNNER, L.L.P.

Dated: September 28, 2010

By: /Weiguo Chen/
Weiguo Chen
Reg. No. 61,878
(650) 849-6600

Under the Paperwork Reduction Act of 1995, no persons are required to respond to a collection of information unless it displays a valid OMB control number.

PATENT APPLICATION FEE DETERMINATION RECORD Substitute for Form PTO-875				Application or Docket Number 11/502,921		Filing Date 08/11/2006		<input type="checkbox"/> To be Mailed					
APPLICATION AS FILED – PART I													
(Column 1)			(Column 2)			SMALL ENTITY <input type="checkbox"/>		OR		OTHER THAN SMALL ENTITY			
FOR		NUMBER FILED	NUMBER EXTRA		RATE (\$)	FEE (\$)	OR		RATE (\$)	FEE (\$)			
<input checked="" type="checkbox"/> BASIC FEE <small>(37 CFR 1.16(a), (b), or (c))</small>		N/A	N/A		N/A				N/A	300			
<input type="checkbox"/> SEARCH FEE <small>(37 CFR 1.16(k), (l), or (m))</small>		N/A	N/A		N/A		N/A						
<input type="checkbox"/> EXAMINATION FEE <small>(37 CFR 1.16(o), (p), or (q))</small>		N/A	N/A		N/A		N/A						
TOTAL CLAIMS <small>(37 CFR 1.16(i))</small>		minus 20 =	*		X \$ =		X \$ =						
INDEPENDENT CLAIMS <small>(37 CFR 1.16(h))</small>		minus 3 =	*		X \$ =		X \$ =						
<input type="checkbox"/> APPLICATION SIZE FEE <small>(37 CFR 1.16(s))</small>		If the specification and drawings exceed 100 sheets of paper, the application size fee due is \$250 (\$125 for small entity) for each additional 50 sheets or fraction thereof. See 35 U.S.C. 41(a)(1)(G) and 37 CFR 1.16(s).											
<input type="checkbox"/> MULTIPLE DEPENDENT CLAIM PRESENT <small>(37 CFR 1.16(j))</small>													
* If the difference in column 1 is less than zero, enter "0" in column 2.													
APPLICATION AS AMENDED – PART II													
(Column 1)			(Column 2)		(Column 3)			SMALL ENTITY		OR		OTHER THAN SMALL ENTITY	
AMENDMENT	09/28/2010		CLAIMS REMAINING AFTER AMENDMENT		HIGHEST NUMBER PREVIOUSLY PAID FOR	PRESENT EXTRA	RATE (\$)	ADDITIONAL FEE (\$)		RATE (\$)	ADDITIONAL FEE (\$)		
	Total <small>(37 CFR 1.16(o))</small>		* 25	Minus	** 20	=	5	X \$ =		OR	X \$25=	260	
	Independent <small>(37 CFR 1.16(h))</small>		* 2	Minus	***3	=	0	X \$ =		OR	X \$220=	0	
	<input type="checkbox"/> Application Size Fee <small>(37 CFR 1.16(s))</small>												
	<input type="checkbox"/> FIRST PRESENTATION OF MULTIPLE DEPENDENT CLAIM <small>(37 CFR 1.16(j))</small>												
							TOTAL ADD'L FEE		OR	TOTAL ADD'L FEE	260		
(Column 1)			(Column 2)		(Column 3)								
AMENDMENT			CLAIMS REMAINING AFTER AMENDMENT		HIGHEST NUMBER PREVIOUSLY PAID FOR	PRESENT EXTRA	RATE (\$)	ADDITIONAL FEE (\$)		RATE (\$)	ADDITIONAL FEE (\$)		
	Total <small>(37 CFR 1.16(o))</small>		*	Minus	**	=		X \$ =		OR	X \$ =		
	Independent <small>(37 CFR 1.16(h))</small>		*	Minus	***	=		X \$ =		OR	X \$ =		
	<input type="checkbox"/> Application Size Fee <small>(37 CFR 1.16(s))</small>												
	<input type="checkbox"/> FIRST PRESENTATION OF MULTIPLE DEPENDENT CLAIM <small>(37 CFR 1.16(j))</small>												
							TOTAL ADD'L FEE		OR	TOTAL ADD'L FEE			
* If the entry in column 1 is less than the entry in column 2, write "0" in column 3.										Legal Instrument Examiner: /TAMMY MCBETH BROWN/			
** If the "Highest Number Previously Paid For" IN THIS SPACE is less than 20, enter "20".													
*** If the "Highest Number Previously Paid For" IN THIS SPACE is less than 3, enter "3".													
The "Highest Number Previously Paid For" (Total or Independent) is the highest number found in the appropriate box in column 1.													

This collection of information is required by 37 CFR 1.16. The information is required to obtain or retain a benefit by the public which is to file (and by the USPTO to process) an application. Confidentiality is governed by 35 U.S.C. 122 and 37 CFR 1.14. This collection is estimated to take 12 minutes to complete, including gathering, preparing, and submitting the completed application form to the USPTO. Time will vary depending upon the individual case. Any comments on the amount of time you require to complete this form and/or suggestions for reducing this burden, should be sent to the Chief Information Officer, U.S. Patent and Trademark Office, U.S. Department of Commerce, P.O. Box 1450, Alexandria, VA 22313-1450. DO NOT SEND FEES OR COMPLETED FORMS TO THIS ADDRESS. **SEND TO: Commissioner for Patents, P.O. Box 1450, Alexandria, VA 22313-1450.**

If you need assistance in completing the form, call 1-800-PTO-9199 and select option 2.



UNITED STATES PATENT AND TRADEMARK OFFICE

UNITED STATES DEPARTMENT OF COMMERCE
United States Patent and Trademark Office
Address: COMMISSIONER FOR PATENTS
P.O. Box 1450
Alexandria, Virginia 22313-1450
www.uspto.gov

APPLICATION NO.	FILING DATE	FIRST NAMED INVENTOR	ATTORNEY DOCKET NO.	CONFIRMATION NO.
11/502,921	08/11/2006	Xiaoqin Duan	30952/42236	9151
22852	7590	07/13/2010	EXAMINER	
FINNEGAN, HENDERSON, FARABOW, GARRETT & DUNNER LLP 901 NEW YORK AVENUE, NW WASHINGTON, DC 20001-4413			TIEU, BINH KIEN	
			ART UNIT	PAPER NUMBER
			2614	
			MAIL DATE	DELIVERY MODE
			07/13/2010	PAPER

Please find below and/or attached an Office communication concerning this application or proceeding.

The time period for reply, if any, is set in the attached communication.

Office Action Summary	Application No.	Applicant(s)	
	11/502,921	DUAN, XIAOQIN	
	Examiner	Art Unit	
	BINH K. TIEU	2614	

-- The MAILING DATE of this communication appears on the cover sheet with the correspondence address --
Period for Reply

A SHORTENED STATUTORY PERIOD FOR REPLY IS SET TO EXPIRE 3 MONTH(S) OR THIRTY (30) DAYS, WHICHEVER IS LONGER, FROM THE MAILING DATE OF THIS COMMUNICATION.

- Extensions of time may be available under the provisions of 37 CFR 1.136(a). In no event, however, may a reply be timely filed after SIX (6) MONTHS from the mailing date of this communication.
- If NO period for reply is specified above, the maximum statutory period will apply and will expire SIX (6) MONTHS from the mailing date of this communication.
- Failure to reply within the set or extended period for reply will, by statute, cause the application to become ABANDONED (35 U.S.C. § 133). Any reply received by the Office later than three months after the mailing date of this communication, even if timely filed, may reduce any earned patent term adjustment. See 37 CFR 1.704(b).

Status

- 1) Responsive to communication(s) filed on 09 June 2010.
- 2a) This action is **FINAL**. 2b) This action is non-final.
- 3) Since this application is in condition for allowance except for formal matters, prosecution as to the merits is closed in accordance with the practice under *Ex parte Quayle*, 1935 C.D. 11, 453 O.G. 213.

Disposition of Claims

- 4) Claim(s) 1-17 is/are pending in the application.
 - 4a) Of the above claim(s) _____ is/are withdrawn from consideration.
- 5) Claim(s) _____ is/are allowed.
- 6) Claim(s) 1-17 is/are rejected.
- 7) Claim(s) _____ is/are objected to.
- 8) Claim(s) _____ are subject to restriction and/or election requirement.

Application Papers

- 9) The specification is objected to by the Examiner.
- 10) The drawing(s) filed on _____ is/are: a) accepted or b) objected to by the Examiner.
 Applicant may not request that any objection to the drawing(s) be held in abeyance. See 37 CFR 1.85(a).
 Replacement drawing sheet(s) including the correction is required if the drawing(s) is objected to. See 37 CFR 1.121(d).
- 11) The oath or declaration is objected to by the Examiner. Note the attached Office Action or form PTO-152.

Priority under 35 U.S.C. § 119

- 12) Acknowledgment is made of a claim for foreign priority under 35 U.S.C. § 119(a)-(d) or (f).
 - a) All b) Some * c) None of:
 - 1. Certified copies of the priority documents have been received.
 - 2. Certified copies of the priority documents have been received in Application No. _____.
 - 3. Copies of the certified copies of the priority documents have been received in this National Stage application from the International Bureau (PCT Rule 17.2(a)).

* See the attached detailed Office action for a list of the certified copies not received.

Attachment(s)

- 1) Notice of References Cited (PTO-892)
- 2) Notice of Draftsperson's Patent Drawing Review (PTO-948)
- 3) Information Disclosure Statement(s) (PTO/SB/08)
 Paper No(s)/Mail Date _____.
- 4) Interview Summary (PTO-413)
 Paper No(s)/Mail Date. _____.
- 5) Notice of Informal Patent Application
- 6) Other: _____.

DETAILED ACTION

Response to Amendment

1. Applicant's arguments with respect to claims 1-17 have been considered but are moot in view of the new ground(s) of rejection.

Claim Rejections - 35 USC § 102

2. The following is a quotation of the appropriate paragraphs of 35 U.S.C. 102 that form the basis for the rejections under this section made in this Office action:

A person shall be entitled to a patent unless –

(e) the invention was described in (1) an application for patent, published under section 122(b), by another filed in the United States before the invention by the applicant for patent or (2) a patent granted on an application for patent by another filed in the United States before the invention by the applicant for patent, except that an international application filed under the treaty defined in section 351(a) shall have the effects for purposes of this subsection of an application filed in the United States only if the international application designated the United States and was published under Article 21(2) of such treaty in the English language.

3. Claims 1-17 are rejected under 35 U.S.C. 102(e) as being anticipated by Syrjala et al. (US. Pat. #: 7,017,050).

Regarding claims 1 and 8, Syrjala et al. ("Syrjala") teaches a universal mobile communications system (UMTS) system 1 comprising an access layer A and a Telephony layer T as shown separated in figure 1. The telephony layer T comprises IP network, a call state control function (CSCF), a media gateway control function (MGCF) and an execution environment (CSE-T) which corresponding to a service control point in an intelligent network. The access layer A comprises a UMTS terrestrial radio access network (UTRAN) and a core network (CN). The CN comprises at least support nodes

Art Unit: 2614

SGSN and GGSN. When user equipment (UE) requests a service by transmitting a connection setup request to the CSCF via the SGSN and GGSN, the reception of the call set-up request results in encountering, at the CSCF, a trigger as (Detection Point) to initiate the service, which cause the CSCF to transmit a request for instructions to the service control function CSE_T. At the CSE_T, information about a prepaid subscription, and the service control function CSE_A is responsible for the prepaid account of the prepaid subscription is determined and located in a database of the CSE_T, i.e., matching to the telephone number of the caller (***see paragraph [0037], it should be understood that the access layer T with the CSCF and CSE_T performed as a Traffic Plane Function (TPF)***). The CSE_T then instructs the CSCF to send a message, included tariff of the telephony operator and all special events, to the CSE_A located in the access layer A as a charging rule request. Thus, ***the CSE_A performed as a Charging Rule Function (CRF), i.e., to apply a tariff to be charged to the prepaid account in according to a billing-related contract (see paragraphs [0038] and [0039]; or the access operator tariff information is requested from the CSE_A, paragraph [0043]***.

Regarding claims 2, 6, 9-10, 13, the telephone number of caller is used as “trigger” to detect the prepaid subscription of an account wherein the account information about services included, inter alia, use of basic telephone, different data bearers, etc. are set by the service provider of the CSE_A (see paragraphs [0037] and [0021]).

Regarding claims 3, 5 and 11, note the feature of setting “arming of detection points” in the CSCF in paragraph [0039].

Regarding claims 4, 12, note the C_ID in paragraphs [0053] and [0054].

Regarding claim 7, note the figure 1, paragraphs [0021] and [0039].

Regarding claim 14, Syrjala teaches a Charging Rule Function (CRF) for controlling charging of packet data service, comprising:

a determining unit, configured to determine an event trigger (*i.e., the SGSN and CSCF encountering a subscriber-specific event (see paragraphs [0035] and [0037]);* and

a providing unit, configured to provide the event trigger to a Traffic Plane Function (TPF) (*i.e. the CSCF and CSE_T sending a message included tariff of the telephony operator and all special events, to the CSE_A located in the access layer A (see paragraphs [0038] and [0039]; or the access operator tariff information is requested from the CSE_A, paragraph [0043]).*

Regarding claim 15, note the feature of setting “arming of detection points” in the CSCF in paragraph [0039].

Regarding claim 16-17, the telephone number of caller is used as “trigger” to detect the prepaid subscription of an account wherein the account information about services included, inter alia, use of basic telephone, different data bearers, etc. are set by the service provider of the CSE_A (see paragraphs [0037] and [0021]).

Art Unit: 2614

4. Any inquiry concerning this communication or earlier communications from the examiner should be directed to Binh K. Tieu whose telephone number is (571) 272-7510 and E-mail address: BINH.TIEU@USPTO.GOV.

If attempts to reach the examiner by telephone are unsuccessful, the examiner's supervisor, Mr. Curtis Kuntz, can be reached on (571) 272-7499 and **IF PAPER HAS BEEN MISSED FROM THIS OFFICIAL ACTION PACKAGE, PLEASE CALL CUSTOMER SERVICE FOR THE SUBSTITUTIONS OR COPIES.**

Any response to this action should be mailed to:
Commissioner of Patents and Trademarks
Washington, D.C. 20231
Or faxed to: (571) 273-8300
Hand Carry Deliveries to:
Customer Service Window
(Randolph Building)
401 Dulany Street
Alexandria, VA 22314

Information regarding the status of an application may be obtained from the Patent Application Information Retrieval (PAIR) system. Status information for published applications may be obtained from either Private PAIR or Public PAIR. Status information for unpublished applications is available through Private PAIR only. For more information about the FAIR system, see <http://pair-direct.uspto.gov>. If you have any questions on access to the Private PAIR system, contact the Electronic Business Center (EBC) at 866-217-9197 (toll-free).

/BINH K. TIEU/
Primary Examiner
Technology Division 2614

Date: July 2010

Notice of References Cited	Application/Control No. 11/502,921	Applicant(s)/Patent Under Reexamination DUAN, XIAOQIN	
	Examiner BINH K. TIEU	Art Unit 2614	Page 1 of 1

U.S. PATENT DOCUMENTS

*		Document Number Country Code-Number-Kind Code	Date MM-YYYY	Name	Classification
*	A	US-2003/0165222	09-2003	Syrjala et al.	379/114.2
	B	US-			
	C	US-			
	D	US-			
	E	US-			
	F	US-			
	G	US-			
	H	US-			
	I	US-			
	J	US-			
	K	US-			
	L	US-			
	M	US-			

FOREIGN PATENT DOCUMENTS

*		Document Number Country Code-Number-Kind Code	Date MM-YYYY	Country	Name	Classification
	N					
	O					
	P					
	Q					
	R					
	S					
	T					

NON-PATENT DOCUMENTS

*		Include as applicable: Author, Title Date, Publisher, Edition or Volume, Pertinent Pages)
	U	
	V	
	W	
	X	

*A copy of this reference is not being furnished with this Office action. (See MPEP § 707.05(a).)
Dates in MM-YYYY format are publication dates. Classifications may be US or foreign.

<i>Index of Claims</i> 	Application/Control No. 11502921	Applicant(s)/Patent Under Reexamination DUAN, XIAOQIN
	Examiner BINH K TIEU	Art Unit 2614

✓	Rejected
=	Allowed

-	Cancelled
÷	Restricted

N	Non-Elected
I	Interference

A	Appeal
O	Objected

Claims renumbered in the same order as presented by applicant
 CPA
 T.D.
 R.1.47

CLAIM		DATE							
Final	Original	11/04/2009	03/20/2010	07/05/2010					
	1	✓	✓	✓					
	2	✓	✓	✓					
	3	✓	✓	✓					
	4	✓	✓	✓					
	5	✓	✓	✓					
	6	✓	✓	✓					
	7		✓	✓					
	8		✓	✓					
	9		✓	✓					
	10		✓	✓					
	11		✓	✓					
	12		✓	✓					
	13		✓	✓					
	14		✓	✓					
	15		✓	✓					
	16		✓	✓					
	17		✓	✓					

Search Notes 	Application/Control No. 11502921	Applicant(s)/Patent Under Reexamination DUAN, XIAOQIN
	Examiner BINH K TIEU	Art Unit 2614

SEARCHED			
Class	Subclass	Date	Examiner
379	111, 114.01, 114.03, 114.05, 114.12, 115.01, 121.01, 124	11/05/2009	BKT
370	356-360, 401	11/05/2009	BKT
UPDATED	SEARCHES	03/20/2010	BKT
455	405-408	03/20/2010	BKT
UPDATED	SEARCHES	07/04/2010	BKT

SEARCH NOTES		
Search Notes	Date	Examiner
WEST DATABASES TERMS SEARCHES	11/05/2009	BKT
WEST DATABASES TERMS SEARCHES	03/19/2010	BKT
WEST DATABASES TERMS SEARCHES	07/04/2010	BKT

INTERFERENCE SEARCH			
Class	Subclass	Date	Examiner

--	--

WEST Search History for Application 11502921

Creation Date: 2010070600:01

Prior Art Searches

Query	DB	Op.	Plur.	Thes.	Date
packet with data service	PGPB, USPT, USOC, EPAB, JPAB, DWPI, TDBD	ADJ	YES		07-05-2010
charg\$3 or bill\$3	PGPB, USPT, USOC, EPAB, JPAB, DWPI, TDBD	ADJ	YES		07-05-2010
(charg\$3 or bill\$3) same (packet with data service)	PGPB, USPT, USOC, EPAB, JPAB, DWPI, TDBD	ADJ	YES		07-05-2010
charg\$3 rule with function	PGPB, USPT, USOC, EPAB, JPAB, DWPI, TDBD	ADJ	YES		07-05-2010
(charg\$3 rule with function) and (charg\$3 or bill\$3 same packet with data service)	PGPB, USPT, USOC, EPAB, JPAB, DWPI, TDBD	ADJ	YES		07-05-2010
370/\$.ccls.	PGPB, USPT, USOC, EPAB, JPAB, DWPI, TDBD	ADJ	YES		07-05-2010
(370/\$.ccls.) and (charg\$3 or bill\$3 same packet with data service)	PGPB, USPT, USOC, EPAB, JPAB, DWPI, TDBD	ADJ	YES		07-05-2010
(370/\$.ccls. and charg\$3 or bill\$3 same packet with data service) not (charg\$3 rule with function and charg\$3 or bill\$3 same packet with data service)	PGPB, USPT, USOC, EPAB, JPAB, DWPI, TDBD	ADJ	YES		07-05-2010
charg\$3 with rull	PGPB, USPT, USOC, EPAB, JPAB, DWPI, TDBD	ADJ	YES		07-05-2010

charg\$3 with rule	PGPB, USPT, USOC, EPAB, JPAB, DWPI, TDBD	ADJ	YES		07-05-2010
(charg\$3 with rule) and (370/\$.ccls. and charg\$3 or bill\$3 same packet with data service not charg\$3 rule with function and charg\$3 or bill\$3 same packet with data service)	PGPB, USPT, USOC, EPAB, JPAB, DWPI, TDBD	ADJ	YES		07-05-2010
379/121.\$ccls.	PGPB, USPT, USOC, EPAB, JPAB, DWPI, TDBD	ADJ	YES		07-05-2010
(379/121.\$ccls.) and (charg\$3 or bill\$3 same packet with data service)	PGPB, USPT, USOC, EPAB, JPAB, DWPI, TDBD	ADJ	YES		07-05-2010



JFW / AF

**RESPONSE AFTER FINAL
EXPEDITED PROCEDURE REQUESTED
EXAMINING GROUP 2614**

PATENT

Attorney Docket No. 11005.0219-00000
Huawei Ref. No. 0410606US

IN THE UNITED STATES PATENT AND TRADEMARK OFFICE

In re Application of:)	
)	Group Art Unit: 2614
Xiaoqin DUAN)	
)	Examiner: Tieu, Binh Kien
Application No.: 11/502,921)	
)	Confirmation No.: 9151
Filed: August 11, 2006)	
)	
For: METHOD FOR CONTROLLING)	Mail Stop AF
CHARGING OF PACKET DATA)	
SERVICE)	
)	

Commissioner for Patents
P.O. Box 1450
Alexandria, VA 22313-1450

Sir:

REQUEST FOR RECONSIDERATION AFTER FINAL

In reply to the Final Office Action mailed March 24, 2010, the period for response to which extends through June 24, 2010, Applicant respectfully requests reconsideration of the above-identified application in view of the following Remarks.

Remarks begin on page 2 of this paper.

REMARKS¹

In the Final Office Action, the Examiner took the following actions:

1. rejected claims 14-16 under 35 U.S.C. § 102(e) as being anticipated by U.S. Patent No. 7,017,050 to Dalton, Jr. et al. ("*Dalton, Jr.*");
2. rejected claims 1-6, 8, 9, 12, and 13 under 35 U.S.C. § 103(a) as being unpatentable over U.S. Patent App. Pub. No. 2004/0255025 to Ricagni ("*Ricagni*") in view of *Dalton, Jr.* or U.S. Patent App. Pub. No. 2005/0135264 to Popoff et al. ("*Popoff*");
3. rejected claims 7, 10, and 11 under 35 U.S.C. § 103(a) as being unpatentable over *Ricagni* in view of *Dalton, Jr.* or *Popoff*, and further in view of U.S. Patent 5,790,642 to Taylor et al. ("*Taylor*"); and
4. rejected claim 17 under 35 U.S.C. § 103(a) as being unpatentable over *Dalton, Jr.* in view of *Taylor*.

Claims 1-17 remain pending in the application. Applicant respectfully traverses the rejections and requests reconsideration and allowance of the pending claims for at least the following reasons.

Rejection of Claims 14-16 under 35 U.S.C. § 102(e)

Applicant respectfully traverses the rejection of claims 14-16 under 35 U.S.C. § 102(e) as being anticipated by *Dalton, Jr.*. In order to properly establish that *Dalton, Jr.* anticipates Applicant's claimed invention under 35 U.S.C. § 102, each

¹ As Applicant's remarks with respect to the Examiner's rejections are sufficient to overcome these rejections, Applicant's silence as to certain assertions or requirements applicable to such rejections (e.g., whether a reference constitutes prior art, motivation to combine references, etc.) is not a concession by Applicant that such assertions are accurate or such requirements have been met, and Applicant reserves the right to analyze and dispute such in the future.

and every element of each of the claims in issue must be found, either expressly described or under principles of inherency, in that single reference. Furthermore, “[t]he identical invention must be shown in as complete detail as is contained in the ... claim.” See M.P.E.P. § 2131, quoting *Richardson v. Suzuki Motor Co.*, 868 F.2d 1126, 1236, 9 U.S.P.Q.2d 1913, 1920 (Fed. Cir. 1989). *Dalton, Jr.* does not disclose each and every element of Applicant’s claimed invention.

Independent claim 14 recites a combination including, for example, “a determining unit, configured to determine an event trigger” and “a providing unit, configured to provide the event trigger to a Traffic Plane Function” (emphases added). *Dalton, Jr.* fails to teach such a combination.

The Office asserted that the user interface 225 of *Dalton, Jr.* corresponds to the claimed “determining unit” and that the identity of the clearinghouse server and/or certificate authority (CA) source certificate of *Dalton, Jr.* correspond to the claimed “event trigger.” Without acquiescing to these assertions, Applicant respectfully notes that, as disclosed in *Dalton, Jr.*, the user interface 225 “provides a mechanism for a user . . . to input information about the clearinghouse environment, including details about enrolled source devices and destination devices.” *Dalton, Jr.*, col. 5, ll. 41-44, (emphasis added). The user interface 225 of *Dalton, Jr.* does not determine the identity of the clearinghouse server or the CA certificate. Therefore, even if the clearinghouse of *Dalton, Jr.* could be reasonably argued to send the identity of the clearinghouse server and/or the CA certificate to a source device, such an identity or CA certificate is not determined by the user interface 225 of *Dalton, Jr.*.

In view of the above, *Dalton, Jr.* fails to teach at least "a determining unit, configured to determine an event trigger" and "a providing unit, configured to provide the event trigger to a Traffic Plane Function," as recited in claim 14 (emphases added). Accordingly, *Dalton, Jr.* cannot anticipate claim 14, and claim 14 is allowable.

Claims 15 and 16 are also allowable at least by virtue of their dependence from claim 14.

Therefore, Applicant respectfully requests that the Examiner reconsider and withdraw the rejection of claims 14-16 under 35 U.S.C. § 102(e).

Rejection of Claims 1-6, 8, 9, 12, and 13 under 35 U.S.C. § 103(a)

Applicant respectfully traverses the rejection of claims 1-6, 8, 9, 12, and 13 under 35 U.S.C. § 103(a) as being unpatentable over *Ricagni* in view of *Dalton, Jr.* or *Popoff*. A *prima facie* case of obviousness has not been established.

"The key to supporting any rejection under 35 U.S.C. 103 is the clear articulation of the reason(s) why the claimed invention would have been obvious. ... [R]ejections on obviousness cannot be sustained with mere conclusory statements." M.P.E.P. § 2142, 8th Ed., Rev. 6 (Sept. 2007) (internal citation and inner quotation omitted). "The mere fact that references can be combined or modified does not render the resultant combination obvious unless the results would have been predictable to one of ordinary skill in the art." M.P.E.P. § 2143.01(III) (emphasis in original). "All words in a claim must be considered in judging the patentability of that claim against the prior art." M.P.E.P. § 2143.03. "In determining the differences between the prior art and the claims, the question under 35 U.S.C. 103 is not whether the differences themselves

would have been obvious, but whether the claimed invention as a whole would have been obvious.” M.P.E.P. § 2141.02(I) (emphases in original).

“[T]he framework for objective analysis for determining obviousness under 35 U.S.C. 103 is stated in *Graham v. John Deere Co.*, 383 U.S. 1, 148 USPQ 459 (1966). ... The factual inquiries ... [include determining the scope and content of the prior art and] ... [a]scertaining the differences between the claimed invention and the prior art.” M.P.E.P. § 2141(II). “Office personnel must explain why the difference(s) between the prior art and the claimed invention would have been obvious to one of ordinary skill in the art.” M.P.E.P. § 2141(III).

Independent claim 1 calls for a combination including, for example, “monitoring, by a Traffic Plane Function (TPF), an event trigger provided by a Charging Rule Function (CRF)” and “sending, by the TPF, a charging rule request to the CRF, if the event trigger is met” (emphasis added). The Office conceded that *Ricagni* does not teach or suggest “an event trigger provided by a Charging Rule Function,” but then relied upon *Dalton, Jr.* or *Popoff* to cure the deficiencies of *Ricagni*. See Final Office Action, pp. 5-6. However, this is not correct.

Regarding *Dalton, Jr.*, the Office asserted that “the calling party 105 sends an outgoing call as a trigger to the source device 110.” Final Office Action, p. 5, (emphasis added). Applicant notes that the Office also asserted that the clearinghouse server of *Dalton, Jr.* corresponds to the claimed “Charging Rule Function.” See Final Office Action, p. 2. Without acquiescing to these assertions, Applicant respectfully submits that the “outgoing call” of *Dalton, Jr.* is not sent or provided by the “clearinghouse server.” Rather, it is sent by the “calling party” as conceded by the Office. See Final

Office Action, p. 5. For at least this reason, *Dalton, Jr.* fails to teach or suggest “an event trigger provided by a Charging Rule Function (CRF)” as recited in claim 1 (emphasis added).

Moreover, *Dalton, Jr.* discloses, with reference to FIG. 3A, “a logical flow chart diagram illustrating exemplary steps completed during the enrollment of a source or destination device for operation with a clearinghouse server.” *Dalton, Jr.*, col.5, ll. 51-53, (emphasis added). *Dalton, Jr.* teaches that “[u]pon device enrollment, a configuration record or file for that device is constructed for storage in the configuration database accessible by the clearinghouse server” (*Dalton, Jr.*, col. 6, ll. 36-39, emphasis added) and that “[r]esponsive to the enrollment request, the clearinghouse server in step 320 creates a public key certificate and sends that certificate to the source device via the IP network.” The clearinghouse server may issue a common public key certificate to all devices, a unique public key certificate to every device, or a unique public key certificate to all devices in a given group. This public key can be used by the source device to initiate secure communications with the clearinghouse server” (*Dalton, Jr.*, col.6, ll. 42-50, emphasis added). That is, *Dalton, Jr.* merely discloses that the source device 110 is previously registered with the clearinghouse server 125, but through the registered steps the clearinghouse server 125 doesn't issue the source device 110 any event trigger, such as an outgoing call alleged by the Office.

Dalton, Jr. further teaches that “the source device 110 sends an authorization request message to the clearinghouse server 125 via the IP network 130 to request the completion of the outgoing call with an available designation device 120. The authorization request typically comprises . . . payment authorization, such as a calling

card number and a personal identification number (PIN)”(Dalton, Jr., col. 3, ll. 51-59, emphasis added) and that “[r]esponsive to the authorization request, the clearinghouse server 125 can send an authorization response to the source device 110 via the IP network 130. The authorization response typically comprises a list identifying one or more available destination devices, the authorization token(s), and the transaction identifier” (Dalton, Jr., col. 4, ll. 7-12, emphases added). In view of these teachings, the authorization response of Dalton, Jr. does not include the charging rule, at least because none of the list identifying one or more available destination devices, the authorization token(s), and the transaction identifier is a charging rule. Therefore, the clearinghouse server 125 of Dalton, Jr. cannot constitute the claimed “Charging Rule Function.”

Regarding *Popoff*, the Office asserted that *Popoff* “teaches that . . . telecommunication carriers and network operators [each having a function of claimed “Charging Rule Function”] . . . supplie[s] their own URIs (as event triggers) to a URIs Matching Engine [of Content Rating middleware platform and gateway system, which reads on the claimed “Traffic Plane Function”],” referring to par. [0024] of *Popoff* for support. Final Office Action, p. 6. However, this assertion is not correct.

Specifically, *Popoff* discloses a computer program product articulated to intermediate HTTP traffic. See, e.g., *Popoff*, par. [0010]. In particular, *Popoff* teaches that “when a wireless subscriber requests some content via HTTP 210, the URI in the HTTP Requests matches an Interesting UR[I] in some URI Matching Rule.” *Popoff*, par. [0030]. However, neither the portion cited by the Office nor any other portions of *Popoff* teaches that such URIs in the URI Matching Rules are provided by the

telecommunications carriers and network operators. Thus, *Popoff* also fails to teach or suggest at least “an event trigger provided by a Charging Rule Function (CRF)” as recited in claim 1 (emphasis added).

Moreover, *Popoff* teaches that “[t]he HTTP request may be directed to servers both within and external to the telecommunications carrier or similar such entity” (*Popoff*, par. [0013], emphasis added) and that “when a wireless subscriber requests some content via HTTP 210, the URI in the HTTP Request routes the HTTP Request to the associated Action Plug-ins for processing. At the first Action Plug-in, the first plug-in in the sequence 01, is activated 220 by the invention 100. This plug-in 220 does some processing of the HTTP Request” (*Popoff*, par. [0030], see, also, FIG. 2, emphasis added).

In view of these teachings, the HTTP request of *Popoff* is sent by the wireless subscriber rather than the Content Rating middleware platform and gateway system (which is asserted by the Office to correspond to the claimed “Traffic Plane Function”), and the HTTP request is sent to the associated Action Plug-ins, as shown in FIG. 2. In *Popoff*, the Action Plug-ins are located in the Content Rating middleware platform and gateway system, rather than the telecommunications carriers and network operators (which are asserted by the Office to have a function of claimed “Charging Rule Function”). Therefore, *Popoff* also fails to teach or suggest “sending, by the TPF, a charging rule request to the CRF, if the event trigger is met” as recited in claim 1.

Popoff further discloses that “[w]hen an HTTP Request triggers the Age Verification plug-in, the plug-in intercepts the HTTP Request and returns a HTTP Response to the subscriber's device. The Response consists of a dynamically created

page which contains the Age Verification screen and contains a link to the originally requested content.” *Popoff*, par. [0028], (emphases added).

That is, *Popoff* in fact discloses that the Response contains nothing about the charging rule, because the “dynamically created page which contains the Age Verification screen and contains a link to the originally requested content” is not a charging rule. The telecommunications carrier of *Popoff* does not provide a charging rule. One of ordinary skill in the art would have recognized that a “telecommunications carrier” is “a company that is authorized by regulatory agencies to operate a telecommunications system.” On the other hand, a “Charging Rule Function” is a network element providing charging rule in the telecommunication network. See, e.g., FIG. 2 of the present application. Therefore, the “telecommunications carrier” of *Popoff* cannot constitute the claimed “Charging Rule Function.”

For at least the reasons discussed above, the Office has neither properly determined the scope and content of the prior art nor properly ascertained the differences between the prior art and claim 1. Moreover, there is no motivation for one of ordinary skill in the art to modify the teachings of the references to achieve the claimed combinations. Thus, no reason has been clearly articulated as to why claim 1 would have been obvious to one of ordinary skill in the art in view of the prior art. Accordingly, a *prima facie* case of obviousness has not been established with respect to claim 1, and claim 1 is allowable.

Independent claim 8, although different in scope from independent claim 1, recites elements similar to those of claim 1. As such, for reasons similar to those

discussed above in regard to the rejection of claim 1, claim 8 is allowable. Claims 2-6, 9, 12, and 13 are also allowable at least by virtue of their dependence from claim 1 or 8.

Therefore, Applicant respectfully requests that the Examiner reconsider and withdraw the rejection of claims 1-6, 8, 9, 12, and 13 under 35 U.S.C. § 103(a).

Rejection of Claims 7, 10, and 11 under 35 U.S.C. § 103(a)

Applicant respectfully traverses the rejection of claims 7, 10, and 11 under 35 U.S.C. § 103(a) as being unpatentable over *Ricagni* in view of *Dalton, Jr.* or *Popoff*, and further in view of *Taylor*. A *prima facie* case of obviousness has not been established.

Claim 7 depends from claim 1 and thus includes all the elements thereof. Claims 10 and 11 depend from claim 8 and thus include all the elements thereof. As discussed above in regard to the rejection of claims 1 and 8, *Ricagni*, *Dalton, Jr.*, and *Popoff*, whether taken alone or in any combination, fail to teach or suggest at least “monitoring, by a Traffic Plane Function (TPF), an event trigger provided by a Charging Rule Function (CRF)” and “sending, by the TPF, a charging rule request to the CRF, if the event trigger is met” as recited in claim 1 (emphasis added) and included in claim 7, and similar elements recited in claim 8 and included in claims 10 and 11.

The Office asserted that *Taylor* “teaches competitively bidding service centers.” Final Office Action, p. 10. Without acquiescing to this assertion, Applicant submits that *Taylor* also fails to teach or suggest the above-quoted elements, and thus does not compensate for the deficiencies of *Ricagni*, *Dalton, Jr.*, and *Popoff*.

For at least the reasons discussed above, the Office has neither properly determined the scope and content of the prior art nor properly ascertained the

differences between the prior art and claims 7, 10, and 11. Moreover, there is no motivation for one of ordinary skill in the art to modify the teachings of the references to achieve the claimed combinations. Thus, no reason has been clearly articulated as to why claims 7, 10, and 11 would have been obvious to one of ordinary skill in the art in view of the prior art. Accordingly, a *prima facie* case of obviousness has not been established with respect to claims 7, 10, and 11, and the claims are allowable.

Therefore, Applicant respectfully requests that the Examiner reconsider and withdraw the rejection of claims 7, 10, and 11 under 35 U.S.C. § 103(a).

Rejection of Claim 17 under 35 U.S.C. § 103(a)

Applicant respectfully traverses the rejection of claim 17 under 35 U.S.C. § 103(a) as being unpatentable over *Dalton, Jr.* in view of *Taylor*. A *prima facie* case of obviousness has not been established.

Claim 17 depends from claim 14 and thus includes all the elements thereof. As discussed above in regard to the rejection of claim 14, *Dalton, Jr.* fails to teach at least “a determining unit, configured to determine an event trigger” and “a providing unit, configured to provide the event trigger to a Traffic Plane Function” as recited in claim 14 (emphases added) and included in claim 17.

The Office asserted that *Taylor* “teaches competitively bidding service centers.” Final Office Action, p. 11. Without acquiescing to this assertion, Applicant submits that *Taylor* also fails to teach or suggest the above-quoted elements, and thus does not compensate for the deficiencies of *Dalton, Jr.*

For at least the reasons discussed above, the Office has neither properly determined the scope and content of the prior art nor properly ascertained the

differences between the prior art and claim 17. Moreover, there is no motivation for one of ordinary skill in the art to modify the teachings of the references to achieve the claimed combinations. Thus, no reason has been clearly articulated as to why claim 17 would have been obvious to one of ordinary skill in the art in view of the prior art.

Accordingly, a *prima facie* case of obviousness has not been established with respect to claim 17, and claim 17 allowable.

Therefore, Applicant respectfully requests that the Examiner reconsider and withdraw the rejection of claim 17 under 35 U.S.C. § 103(a).

CONCLUSION

In view of the foregoing remarks, Applicant respectfully requests reconsideration and reexamination of this application and the timely allowance of the pending claims.

Please grant any extensions of time required to enter this response and charge any additional required fees to Deposit Account 06-0916.

Respectfully submitted,

FINNEGAN, HENDERSON, FARABOW,
GARRETT & DUNNER, L.L.P.

Dated: June 9, 2010

By: /Weiguo Chen/
Weiguo Chen
Reg. No. 61,878
(650) 849-6600



UNITED STATES PATENT AND TRADEMARK OFFICE

UNITED STATES DEPARTMENT OF COMMERCE
United States Patent and Trademark Office
Address: COMMISSIONER FOR PATENTS
P.O. Box 1450
Alexandria, Virginia 22313-1450
www.uspto.gov

APPLICATION NO.	FILING DATE	FIRST NAMED INVENTOR	ATTORNEY DOCKET NO.	CONFIRMATION NO.
11/502,921	08/11/2006	Xiaoqin Duan	30952/42236	9151
22852	7590	03/24/2010	EXAMINER	
FINNEGAN, HENDERSON, FARABOW, GARRETT & DUNNER LLP 901 NEW YORK AVENUE, NW WASHINGTON, DC 20001-4413			TIEU, BINH KIEN	
			ART UNIT	PAPER NUMBER
			2614	
			MAIL DATE	DELIVERY MODE
			03/24/2010	PAPER

Please find below and/or attached an Office communication concerning this application or proceeding.

The time period for reply, if any, is set in the attached communication.

Office Action Summary	Application No. 11/502,921	Applicant(s) DUAN, XIAOQIN	
	Examiner BINH K. TIEU	Art Unit 2614	

-- The MAILING DATE of this communication appears on the cover sheet with the correspondence address --
Period for Reply

A SHORTENED STATUTORY PERIOD FOR REPLY IS SET TO EXPIRE _____ MONTH(S) OR THIRTY (30) DAYS, WHICHEVER IS LONGER, FROM THE MAILING DATE OF THIS COMMUNICATION.

- Extensions of time may be available under the provisions of 37 CFR 1.136(a). In no event, however, may a reply be timely filed after SIX (6) MONTHS from the mailing date of this communication.
- If NO period for reply is specified above, the maximum statutory period will apply and will expire SIX (6) MONTHS from the mailing date of this communication.
- Failure to reply within the set or extended period for reply will, by statute, cause the application to become ABANDONED (35 U.S.C. § 133). Any reply received by the Office later than three months after the mailing date of this communication, even if timely filed, may reduce any earned patent term adjustment. See 37 CFR 1.704(b).

Status

- 1) Responsive to communication(s) filed on 12 January 2010.
- 2a) This action is **FINAL**. 2b) This action is non-final.
- 3) Since this application is in condition for allowance except for formal matters, prosecution as to the merits is closed in accordance with the practice under *Ex parte Quayle*, 1935 C.D. 11, 453 O.G. 213.

Disposition of Claims

- 4) Claim(s) 1-17 is/are pending in the application.
4a) Of the above claim(s) _____ is/are withdrawn from consideration.
- 5) Claim(s) _____ is/are allowed.
- 6) Claim(s) 1-17 is/are rejected.
- 7) Claim(s) _____ is/are objected to.
- 8) Claim(s) _____ are subject to restriction and/or election requirement.

Application Papers

- 9) The specification is objected to by the Examiner.
- 10) The drawing(s) filed on _____ is/are: a) accepted or b) objected to by the Examiner.
Applicant may not request that any objection to the drawing(s) be held in abeyance. See 37 CFR 1.85(a).
Replacement drawing sheet(s) including the correction is required if the drawing(s) is objected to. See 37 CFR 1.121(d).
- 11) The oath or declaration is objected to by the Examiner. Note the attached Office Action or form PTO-152.

Priority under 35 U.S.C. § 119

- 12) Acknowledgment is made of a claim for foreign priority under 35 U.S.C. § 119(a)-(d) or (f).
a) All b) Some * c) None of:
1. Certified copies of the priority documents have been received.
2. Certified copies of the priority documents have been received in Application No. _____.
3. Copies of the certified copies of the priority documents have been received in this National Stage application from the International Bureau (PCT Rule 17.2(a)).

* See the attached detailed Office action for a list of the certified copies not received.

Attachment(s)

- | | |
|---|--|
| 1) <input checked="" type="checkbox"/> Notice of References Cited (PTO-892) | 4) <input type="checkbox"/> Interview Summary (PTO-413)
Paper No(s)/Mail Date. _____. |
| 2) <input type="checkbox"/> Notice of Draftsperson's Patent Drawing Review (PTO-948) | 5) <input type="checkbox"/> Notice of Informal Patent Application |
| 3) <input checked="" type="checkbox"/> Information Disclosure Statement(s) (PTO/SB/08)
Paper No(s)/Mail Date <u>02/25/2010</u> . | 6) <input type="checkbox"/> Other: _____. |

DETAILED ACTION

Response to Amendment

1. The Applicant's amendment filed on 01/12/2010 was entered. Claims 1-6 were amended. New claims 7-17 were added as new claims. As the results, claims 1-17 are pending in this application at this time.

Claim Rejections - 35 USC § 102

2. The following is a quotation of the appropriate paragraphs of 35 U.S.C. 102 that form the basis for the rejections under this section made in this Office action:

A person shall be entitled to a patent unless –

(e) the invention was described in (1) an application for patent, published under section 122(b), by another filed in the United States before the invention by the applicant for patent or (2) a patent granted on an application for patent by another filed in the United States before the invention by the applicant for patent, except that an international application filed under the treaty defined in section 351(a) shall have the effects for purposes of this subsection of an application filed in the United States only if the international application designated the United States and was published under Article 21(2) of such treaty in the English language.

3. Claims 14-16 are rejected under 35 U.S.C. 102(e) as being anticipated by Dalton, Jr. et al. (US. Pat. #: 7,017,050).

Regarding claim 14, Dalton, Jr. et al. ("Dalton, Jr.") teaches a Charging Rule Function (CRF), i.e., Clearinghouse server as shown in figure 2, for controlling charging packet data service (i.e., controlling duration of call such number of packets, frames, etc. (see col.15, lines 33-35)), comprising:

a determining unit, configured to determine an event trigger (i.e., the user interface 225 is configured to determine and to assign source devices as "user" or

“users” of the group, or subscriber of clearinghouse services (see col.5, lines 41 through col.6, line 7)); and

a providing unit, configured to provide the event trigger to a Traffic Plane Function (TPF) (i.e. identity of the clearinghouse server and/or certificate authority source (CA) certificate (read on “triggers”) is/are transmitted to source device(s), see col.6, lines 13-22).

Regarding claim 15, Dalton, Jr. further teaches the source device registered with the clearinghouse service for services provided by the clearinghouse and the clearinghouse server providing charging rule, such as the maximum length a call, etc. is set by the clearinghouse server. Dalton also teaches that the request message sent from the source device is also comprised the telephone numbers of the caller and called parties, and other information related to subscriber (calling party) (see col.11, lines 26-40), and bear characteristics information and network information such as information related to a roamer and another firm, source device group, etc. (see col.12, lines 16-29).

Regarding claim 16, Dalton, Jr. further teaches the triggers included a call from a calling party roaming from another firm (col.12, lines 20-27). Thus, the trigger included a bear modification event.

Claim Rejections - 35 USC § 103

4. The following is a quotation of 35 U.S.C. 103(a) which forms the basis for all obviousness rejections set forth in this Office action:

(a) A patent may not be obtained though the invention is not identically disclosed or described as set forth in section 102 of this title, if the differences between the subject matter sought to be patented and the prior art are such that the subject matter as a whole would have been obvious at the time the

invention was made to a person having ordinary skill in the art to which said subject matter pertains. Patentability shall not be negated by the manner in which the invention was made.

This application currently names joint inventors. In considering patentability of the claims under 35 U.S.C. 103(a), the examiner presumes that the subject matter of the various claims was commonly owned at the time any inventions covered therein were made absent any evidence to the contrary. Applicant is advised of the obligation under 37 CFR 1.56 to point out the inventor and invention dates of each claim that was not commonly owned at the time a later invention was made in order for the examiner to consider the applicability of 35 U.S.C. 103(c) and potential 35 U.S.C. 102(e), (f) or (g) prior art under 35 U.S.C. 103(a).

5. Claims 1-6, 8-9, and 12-13 are rejected under 35 U.S.C. 103(a) as being unpatentable over Ricagni (Pub. No.: US 2004/0255025 **as cited in the previous Office Action**) in view Dalton, Jr. et al. (US. Pat. #: 7,017,050) or Popoff et al. (Pub. No.: US 2005/0135264).

Regarding claim 1, Ricagni teaches a method for controlling the charging of packet data service, comprising of:

monitoring, by a Traffic Plane Function (TPF), an event trigger (para. [0085]); and sending, by the TPF, a charging rule request to a Charging Rule Function (CRF), when one of said event trigger is met (i.e., TPF (8) sends a message (read on charging rule request) to event owner (14) as shown in para. [0100]-[0105], and the event owner (14) replies to the TPF (8) with an event result specified a cost code as shown in examples 2 and 4 in TABLE ONE, see para. [0106], [0109], [0111] and [0113]).

It should be noticed that Ricagni discloses that "the gateway (8) is setup by the network operator to associate a particular trigger with service flows to the application server (12) based on the service flow matching triggering criteria [box B in FIG, 3a] ... The TPF (8) then sends a message [Box E in FIG. 34] to the event owner containing" (para. [0072]- [0100]), emphasis added), as argued by the Applicants. Thus, Ricagni fails to clearly teach that (1) the owner (i.e., a service provider, telecommunications carrier, etc.) previously registered with the operator for an event trigger associated with a specific event to be provided at the TPF or (2) the operator allowed owners (of telecommunications carriers) to place their own triggers at the TPF, so that when an event trigger is monitored and detected, wherein the event trigger was provided by an event trigger provided by a CRF (i.e., of telecommunications carrier), as argued by the Applicants in their remarks.

However, Dalton, Jr. et al. (Dalton, Jr.) teaches a clearinghouse server for internet telephony and multimedia communications, as shown in figure 1, comprising calling and called party 105 and 115, originating gateway (source device) 110, terminating gateway (destination device) 120 and clearinghouse server 125. Dalton, Jr. further teaches that the source device 110 is previously registered with the clearinghouse server 125 and is an authorized user of the clearinghouse services provided by the clearinghouse service 125 as a result of enrolling for operation with that server. When the calling party 105 sends an outgoing call as a trigger to the source device 110. The source device 110 detects the call or trigger and sends an authorization request message included at least a charging rule such as payment

authorization to the clearinghouse server 125 (see col.3, lines 42-60 and col.5, lines 29-40).

Popoff et al. ("Popoff") teaches an Intelligent Content Rating middleware platform and gateway system as shown in figure 1. Popoff further teaches that the Content Rating middleware platform and gateway system permits telecommunication carriers and network operators (to be registered and supplied their own URIs (as event triggers) to a URIs Matching Engine) to provide their own requisite flexibility and fluidity over the action which occur when subscriber's trigger matches though the URI Matching engine of Content Rating middleware platform and gateway system (see paragraph [0024]). In the other words, Popoff teaches that the telecommunication carriers (each having a function of CRF) provided their own URIs as "triggers" into the Content Rating middleware platform and gateway system 100 (operated or read on "TPF"). A request of HTTP is generated and directed to servers of the telecommunications carriers if the URI matched to the one of the URIs provided by the telecommunications carriers (see paragraphs [0013], [0021] and [0023]).

Therefore, it would have been obvious to one of ordinary skill in the art at the time the invention was made to incorporate the use of the feature of monitoring, by a Traffic Plane Function (TPF), provided by an event trigger provided by a CRE, as taught by Dalton, Jr. or Popoff, into view of Ricagni in order to bill the users by service/content providers with accurate charge rates for services they rendered.

Regarding claim 2, Dalton, Jr. further teaches the triggers included a call from a calling party roaming from another firm (col.12, lines 20-27). Thus, the trigger included a bear modification event.

Regarding claim 3, Popoff further teaches the telecommunications carriers (read on CRF) provided or registered their own URIs into the URI Matching Engine (read on "TPF") wherein each of the URIs associated with Action Plug-ins. When the URI of interest is detected, the associated Plug-ins are retrieved (see para. [0024]).

Regarding claim 4, Dalton, Jr. further teaches that that the authorization request message sent to the clearinghouse server comprises a call identifier (read on even identifier) indicating the outgoing call (read on event trigger) in col.3, lines 51-56.

Regarding claim 5, Dalton, Jr. further teaches the feature of determining the maximum call length for which a call may be authorized as a charging rule, and the value of the maximum length of the call may be included on the authorization response to the source device (see col.12, line 64 through col.13, line 2).

Regarding claim 6, the combination of Ricagni, Dalton, Jr. and/or Popoff teach the limitations of the claim, such as Dalton, Jr. teaches the source device registered with the clearinghouse service for services provided by the clearinghouse and the clearinghouse server providing charging rule, such as the maximum length a call, etc. is set by the clearinghouse server. Dalton also teaches that the request message sent from the source device is also comprised the telephone numbers of the caller and called parties, and other information related to subscriber (calling party) (see col.11, lines 26-

40), and bear characteristics information and network information such as information related to a roamer and another firm, source device group, etc. (see col.12, lines 16-29).

Regarding claim 8, Ricagni teaches a Traffic Plane Function (TPF) for controlling the charging of packet data service, comprising of:

a monitoring unit, configured to monitor, an event trigger (para. [0085]); and
a sending unit, configured to send a charging rule request to a Charging Rule Function (CRF), when one of said event trigger is met (i.e., TPF (8) sends a message (read on charging rule request) to event owner (14) as shown in para. [0100]-[0105], and the event owner (14) replies to the TPF (8) with an event result specified a cost code as shown in examples 2 and 4 in TABLE ONE, see para. [0106], [0109], [0111] and [0113]).

It should be noticed that Ricagni discloses that "the gateway (8) is setup by the network operator to associate a particular trigger with service flows to the application server (12) based on the service flow matching triggering criteria [box B in FIG, 3a] ... The TPF (8) then sends a message [Box E in FIG. 34] to the event owner containing" (para. [0072]- [0100]), emphasis added), as argued by the Applicants. Thus, Ricagni fails to clearly teach that (1) the owner (i.e., a service provider, telecommunications carrier, etc.) previously registered with the operator for an event trigger associated with a specific event to be provided at the TPF or (2) the operator allowed owners (of telecommunications carriers) to place their own triggers at the TPF, so that when an event trigger is monitored and detected, wherein the event trigger was provided by an

event trigger provided by a CRF (i.e., of telecommunications carrier), as argued by the Applicants in their remarks.

However, Dalton, Jr. et al. (Dalton, Jr.) teaches a clearinghouse server for internet telephony and multimedia communications, as shown in figure 1, comprising calling and called party 105 and 115, originating gateway (source device) 110, terminating gateway (destination device) 120 and clearinghouse server 125. Dalton, Jr. further teaches that the source device 110 is previously registered with the clearinghouse server 125 and is an authorized user of the clearinghouse services provided by the clearinghouse service 125 as a result of enrolling for operation with that server. When the calling party 105 sends an outgoing call as a trigger to the source device 110. The source device 110 detects the call or trigger and sends an authorization request message included at least a charging rule such as payment authorization to the clearinghouse server 125 (see col.3, lines 42-60 and col.5, lines 29-40).

Regarding claim 9, Dalton, Jr. further teaches the triggers included a call from a calling party roaming from another firm (col.12, lines 20-27). Thus, the trigger included a bear modification event.

Regarding claim 12, Dalton, Jr. further teaches that that the authorization request message sent (by the source device 110) to the clearinghouse server comprises a call identifier (read on even identifier) indicating the outgoing call (read on event trigger) in col.3, lines 51-56.

Regarding claim 13, Dalton, Jr. further teaches the feature of determining the maximum call length for which a call may be authorized as a charging rule, and the value of the maximum length of the call may be included on the authorization response to the source device (see col.12, line 64 through col.13, line 2).

6. Claims 7 and 10-11 are rejected under 35 U.S.C. 103(a) as being unpatentable over Ricagni (Pub. No.: US 2004/0255025) in view Dalton, Jr. et al. (US. Pat. #: 7,017,050) or Popoff et al. (Pub. No.: US 2005/0135264) as applied to claims 1 and 8 above, and further in view of Taylor et al. (US. Pat. #: 5,790,642).

Regarding claim 7 and 10, Ricagni, Dalton, Jr. and/or Popoff, in combination, teaches all subject matters as claimed above, except for a feature of the bearer modification event comprising a change of a network, such as SGSN, PLMN, etc. However, Taylor et al. ("Taylor") teaches competitively bidding service centers, as shown in figure 1. Each of the competitively bidding service centers, prior to place a bid, has to determine and calculate a cost based upon the load presently operating at a particular one of the centers, such as status of busy of a center, overloaded conditions that will be suffered or delayed (see col.5, lines 30-44). Thus, before a call center provides a bid (event trigger), the event trigger (bid) is calculated and derived from a change (condition) of the network.

Therefore, it would have been obvious to one of ordinary skill in the art at the time the invention was made to incorporate the use of the feature of the feature of the bearer modification event comprising a change of a network such as busy, overloaded

conditions, etc. of the network, as taught by Taylor. It is also noticed that Taylor teaches the bid is calculated factoring busy and overloaded conditions of the PSTN network. It is also obvious to be applied into other networks or services such as SGSN, PLMN, RAT, TFT or QoS for a purpose of provide better telecommunications services to subscribers.

Therefore, it would have been obvious to one of ordinary skilled in the art at the time the invention was made to incorporate the use of the feature of the bearer modification event comprising a change of network as taught by Taylor, such as a change of SGSN, a change of PLMN, etc., into view of Ricagni, Dalton and/or Popoff in order to provide better telecommunications services to subscribers.

Regarding claim 11, Popoff further teaches the telecommunications carriers (read on CRF) provided or registered their own URIs into the URI Matching Engine (read on "TPF") wherein each of the URIs associated with Action Plug-ins. When the URI of interest is detected, the associated Plug-ins are retrieved (see para. [0024]).

7. Claim 17 is rejected under 35 U.S.C. 103(a) as being unpatentable over Dalton, Jr. et al. (US. Pat. #: 7,017,050) in view of Taylor et al. (US. Pat. #: 5,790,642).

Regarding claim 17, Dalton, Jr. teaches all subject matters as claimed above, except for a feature of the bearer modification event comprising a change of a network, such as SGSN, PLMN, etc. However, Taylor et al. ("Taylor") teaches competitively bidding service centers, as shown in figure 1. Each of the competitively bidding service centers, prior to place a bid, has to determine and calculate a cost based upon the load presently operating at a particular one of the centers, such as status of busy of a center,

overloaded conditions that will be suffered or delayed (see col.5, lines 30-44). Thus, before a call center provides a bid (event trigger), the event trigger (bid) is calculated and derived from a change (condition) of the network.

Therefore, it would have been obvious to one of ordinary skill in the art at the time the invention was made to incorporate the use of the feature of the feature of the bearer modification event comprising a change of a network such as busy, overloaded conditions, etc. of the network, as taught by Taylor. It is also noticed that Taylor teaches the bid is calculated factoring busy and overloaded conditions of the PSTN network. It is also obvious to be applied into other networks or services such as SGSN, PLMN, RAT, TFT or QoS for a purpose of provide better telecommunications services to subscribers.

Therefore, it would have been also obvious to one of ordinary skilled in the art at the time the invention was made to incorporate the use of the feature of the bearer modification event comprising a change of network as taught by Taylor, such as a change of SGSN, a change of PLMN, etc., into view of Ricagni, Dalton and/or Popoff in order to provide better telecommunications services to subscribers.

Response to Arguments

8. Applicant's arguments with respect to claims 1-6 have been considered but are moot in view of the new ground(s) of rejection.

Applicant's amendment necessitated the new ground(s) of rejection presented in this Office action. Accordingly, **THIS ACTION IS MADE FINAL**. See MPEP § 706.07(a). Applicant is reminded of the extension of time policy as set forth in 37 CFR 1.136(a).

A shortened statutory period for response to this final action is set to expire **THREE MONTHS** from the date of this action. In the event a first response is filed

Art Unit: 2614

within TWO MONTHS of the mailing date of this final action and the advisory action is not mailed until after the end of the THREE-MONTH shortened statutory period, then the shortened statutory period will expire on the date the advisory action is mailed, and any extension fee pursuant to 37 CFR 1.136(a) will be calculated from the mailing date of the advisory action. In no event will the statutory period for response expire later than SIX MONTHS from the date of this final action.

Any response to this final action should be mailed to:

Box AF

**Commissioner of Patents and Trademarks
Washington, D.C. 20231**

Or faxed to:

**(703) 872-9314 or (571) 273-8300 (for formal communications;
"EXPEDITED PROCEDURE")**

please mark

Or:

**If it is an informal or draft communication, please label
"PROPOSED" or "DRAFT")**

Hand Carry Deliveries to:

Customer Service Window
(Randolph Building)
401 Dulany Street
Alexandria, VA 22314

9. Any inquiry concerning this communication or earlier communications from the examiner should be directed to Binh K. Tieu whose telephone number is (571) 272-7510 and E-mail address: BINH.TIEU@USPTO.GOV.

If attempts to reach the examiner by telephone are unsuccessful, the examiner's supervisor, Mr. Curtis Kuntz, can be reached on (571) 272-7499 and **IF PAPER HAS BEEN MISSED FROM THIS OFFICIAL ACTION PACKAGE, PLEASE CALL CUSTOMER SERVICE FOR THE SUBSTITUTIONS OR COPIES.**

Information regarding the status of an application may be obtained from the Patent Application Information Retrieval (PAIR) system. Status information for published applications may be obtained from either Private PAIR or Public PAIR. Status information for unpublished applications is available through Private PAIR only. For more information about the PAIR system, see <http://pair-direct.uspto.gov>. If you have any questions on access to the Private PAIR system, contact the Electronic Business Center (EBC) at 866-217-9197 (toll-free).

/BINH K. TIEU/
Primary Examiner
Technology Division 2614

Date: March 2010

Application/Control Number: 11/502,921
Art Unit: 2614

Page 14

Notice of References Cited	Application/Control No. 11/502,921	Applicant(s)/Patent Under Reexamination DUAN, XIAOQIN	
	Examiner BINH K. TIEU	Art Unit 2614	Page 1 of 1

U.S. PATENT DOCUMENTS

*	Document Number Country Code-Number-Kind Code	Date MM-YYYY	Name	Classification
*	A US-7,017,050	03-2006	Dalton et al.	726/5
*	B US-2005/0135264	06-2005	Popoff et al.	370/252
*	C US-5,790,642	08-1998	Taylor et al.	379/114.02
	D US-			
	E US-			
	F US-			
	G US-			
	H US-			
	I US-			
	J US-			
	K US-			
	L US-			
	M US-			

FOREIGN PATENT DOCUMENTS

*	Document Number Country Code-Number-Kind Code	Date MM-YYYY	Country	Name	Classification
	N				
	O				
	P				
	Q				
	R				
	S				
	T				

NON-PATENT DOCUMENTS

*	Include as applicable: Author, Title Date, Publisher, Edition or Volume, Pertinent Pages)
U	
V	
W	
X	

*A copy of this reference is not being furnished with this Office action. (See MPEP § 707.05(a).)
Dates in MM-YYYY format are publication dates. Classifications may be US or foreign.

Search Notes 	Application/Control No. 11502921	Applicant(s)/Patent Under Reexamination DUAN, XIAOQIN
	Examiner BINH K TIEU	Art Unit 2614

SEARCHED			
Class	Subclass	Date	Examiner
379	111, 114.01, 114.03, 114.05, 114.12, 115.01, 121.01, 124	11/05/2009	BKT
370	356-360, 401	11/05/2009	BKT
UPDATED	SEARCHES	03/20/2010	BKT
455	405-408	03/20/2010	BKT

SEARCH NOTES		
Search Notes	Date	Examiner
WEST DATABASES TERMS SEARCHES	11/05/2009	BKT
WEST DATABASES TERMS SEARCHES	03/19/2010	BKT

INTERFERENCE SEARCH			
Class	Subclass	Date	Examiner

--	--

<i>Index of Claims</i> 	Application/Control No. 11502921	Applicant(s)/Patent Under Reexamination DUAN, XIAOQIN
	Examiner BINH K TIEU	Art Unit 2614

✓	Rejected
=	Allowed

-	Cancelled
÷	Restricted

N	Non-Elected
I	Interference

A	Appeal
O	Objected

Claims renumbered in the same order as presented by applicant
 CPA
 T.D.
 R.1.47

CLAIM		DATE							
Final	Original	11/04/2009	03/20/2010						
	1	✓	✓						
	2	✓	✓						
	3	✓	✓						
	4	✓	✓						
	5	✓	✓						
	6	✓	✓						
	7		✓						
	8		✓						
	9		✓						
	10		✓						
	11		✓						
	12		✓						
	13		✓						
	14		✓						
	15		✓						
	16		✓						
	17		✓						

IDS Form PTO/SB/08: Substitute for form 1449A/PTO		Complete if Known				
INFORMATION DISCLOSURE STATEMENT BY APPLICANT <i>(Use as many sheets as necessary)</i>		<i>Application Number</i>	11/502,921			
		<i>Filing Date</i>	August 11, 2006			
		<i>First Named Inventor</i>	Xiaoqin Duan			
		<i>Art Unit</i>	2614			
		<i>Examiner Name</i>	Tieu, Binh Kien			
<div style="border: 1px solid black; border-radius: 50%; padding: 5px; display: inline-block;"> OPA Sheet FEB 25 2010 PATENT & TRADEMARK OFFICE </div>		1	of	2	<i>Attorney Docket Number</i>	11005.0219-00000

U.S. PATENTS AND PUBLISHED U.S. PATENT APPLICATIONS						
Examiner Initials	Cite No. ¹	Document Number		Issue or Publication Date MM-DD-YYYY	Name of Patentee or Applicant of Cited Document	Pages, Columns, Lines, Where Relevant Passages or Relevant Figures Appear
		Number-Kind Code ² (if known)				
/BKT/		US - 5,757,894 (A)		05-26-1998	Kay William	

Note: Submission of copies of U.S. Patents and published U.S. Patent Applications is not required.

FOREIGN PATENT DOCUMENTS							
Examiner Initials	Cite No. ¹	Foreign Patent Document		Publication Date MM-DD-YYYY	Name of Patentee or Applicant of Cited Document	Pages, Columns, Lines, Where Relevant Passages or Relevant Figures Appear	Translation ⁶
		Country Code ³	Number ⁴ Kind Code ⁵ (if known)				
/BKT/		CN	1303781 C	03-07-2007	HUAWEI TECHNOLOGIES CO. LTD [CN]		Abstract only
/BKT/		CN	1222017 A	07-07-1999	IBM [US]		Abstract only
/BKT/		CN	1444824 A	09-24-2003	NOKIA CORP [FI]		Abstract only
/BKT/		CN	1452333 A	10-29-2003	HUAWEI TECHNOLOGIES CO. LTD [CN]		Abstract only
/BKT/		CN	1472920 A	02-04-2004	HUAWEI TECHNOLOGIES CO. LTD [CN]		Abstract only

NONPATENT LITERATURE DOCUMENTS			
Examiner Initials	Cite No. ¹	Include name of the author (in CAPITAL LETTERS), title of the article (when appropriate), title of the item (book, magazine, journal, serial, symposium, catalog, etc.), date, page(s), volume-issue number(s), publisher, city and/or country where published.	Translation ⁶
/BKT/		European Official Communication pursuant to Article 94(3) EPC for Application No. 05738259.0, dated January 16, 2008.	
/BKT/		Notice of Final Rejection - Official Action for Application No.: 2007-503178, dated December 15, 2009. Partial English Translation, 3 pages.	Yes
/BKT/		Chinese Office Action in related Chinese Patent Application No.: 2004100337219, dated October 21, 2005, with English Translation	Yes

Examiner:

/BINH TIEU/

Date:

03/20/2010

WEST Search History for Application 11502921

Creation Date: 2010032023:28

Prior Art Searches

Query	DB	Op.	Plur.	Thes.	Date
tpf and crf	PGPB, USPT, USOC, EPAB, JPAB, DWPI, TDBD	ADJ	YES		03-10-2010
charg\$3 with rule	PGPB, USPT, USOC, EPAB, JPAB, DWPI, TDBD	ADJ	YES		03-10-2010
(charg\$3 with rule) and (tpf and crf)	PGPB, USPT, USOC, EPAB, JPAB, DWPI, TDBD	ADJ	YES		03-10-2010
tpf	PGPB, USPT, USOC, EPAB, JPAB, DWPI, TDBD	ADJ	YES		03-10-2010
(tpf) and (charg\$3 with rule)	PGPB, USPT, USOC, EPAB, JPAB, DWPI, TDBD	ADJ	YES		03-10-2010
(tpf and charg\$3 with rule) not (charg\$3 with rule and tpf and crf)	PGPB, USPT, USOC, EPAB, JPAB, DWPI, TDBD	ADJ	YES		03-10-2010
SGSN or PLMN or QoS or TFT	PGPB, USPT, USOC, EPAB, JPAB, DWPI, TDBD	ADJ	YES		03-11-2010
change with (SGSN or PLMN or QoS or TFT)	PGPB, USPT, USOC, EPAB, JPAB, DWPI, TDBD	ADJ	YES		03-11-2010
CRF	PGPB, USPT, USOC, EPAB, JPAB, DWPI, TDBD	ADJ	YES		03-11-2010

(CRF) and (change with SGSN or PLMN or QoS or TFT)	PGPB, USPT, USOC, EPAB, JPAB, DWPI, TDBD	ADJ	YES		03-11-2010
455/407-409.ccls.	PGPB, USPT, USOC, EPAB, JPAB, DWPI, TDBD	ADJ	YES		03-11-2010
(455/407-409.ccls.) and (CRF)	PGPB, USPT, USOC, EPAB, JPAB, DWPI, TDBD	ADJ	YES		03-11-2010
(455/407-409.ccls.) and (change with SGSN or PLMN or QoS or TFT)	PGPB, USPT, USOC, EPAB, JPAB, DWPI, TDBD	ADJ	YES		03-11-2010
(455/407-409.ccls. and change with SGSN or PLMN or QoS or TFT) not (CRF and change with SGSN or PLMN or QoS or TFT)	PGPB, USPT, USOC, EPAB, JPAB, DWPI, TDBD	ADJ	YES		03-11-2010
ocs or (online or on-line) service	PGPB, USPT, USOC, EPAB, JPAB, DWPI, TDBD	ADJ	YES		03-11-2010
tpf	PGPB, USPT, USOC, EPAB, JPAB, DWPI, TDBD	ADJ	YES		03-11-2010
(tpf) and (ocs or (online or on-line) service)	PGPB, USPT, USOC, EPAB, JPAB, DWPI, TDBD	ADJ	YES		03-11-2010
charg\$3 (rule or policies)	PGPB, USPT, USOC, EPAB, JPAB, DWPI, TDBD	ADJ	YES		03-11-2010
(charg\$3 (rule or policies)) and (tpf and ocs or (online or on-line) service)	PGPB, USPT, USOC, EPAB, JPAB, DWPI, TDBD	ADJ	YES		03-11-2010
(charg\$3 (rule or policies) and tpf and ocs or (online or on-line) service) not (CRF and change with SGSN or PLMN or QoS or TFT)	PGPB, USPT, USOC, EPAB, JPAB, DWPI, TDBD	ADJ	YES		03-11-2010

tieu.xa.	PGPB, USPT, USOC, EPAB, JPAB, DWPI, TDBD	ADJ	YES		03-14-2010
tieu, binh.xa.	PGPB, USPT, USOC, EPAB, JPAB, DWPI, TDBD	ADJ	YES		03-14-2010
379/114.\$ccls.	PGPB, USPT, USOC, EPAB, JPAB, DWPI, TDBD	ADJ	YES		03-14-2010
(379/114.\$ccls.) and (tieu, binh.xa.)	PGPB, USPT, USOC, EPAB, JPAB, DWPI, TDBD	ADJ	YES		03-14-2010
(379/114.\$ccls. and tieu, binh.xa.) and agent	PGPB, USPT, USOC, EPAB, JPAB, DWPI, TDBD	ADJ	YES		03-14-2010
5675636	PGPB, USPT, USOC, EPAB, JPAB, DWPI, TDBD	ADJ	YES		03-14-2010
packet with service	PGPB, USPT, USOC, EPAB, JPAB, DWPI, TDBD	ADJ	YES		03-14-2010
(packet with service) and (5675636)	PGPB, USPT, USOC, EPAB, JPAB, DWPI, TDBD	ADJ	YES		03-14-2010
5675636.pn.	PGPB, USPT, USOC, EPAB, JPAB, DWPI, TDBD	ADJ	YES		03-14-2010
('4972464' '5289536' '5291550' '5400395' '5425085' '5473630' '5488655' '5528678' '5530744' '5553124' '5553131' '5606602')![pn]	USPT, PGPB	ADJ	YES		03-14-2010
(379/114.\$ccls.) and (packet with service)	PGPB, USPT, USOC, EPAB, JPAB, DWPI, TDBD	ADJ	YES		03-14-2010

least cost or bid or (cheap\$4 with carrier)	PGPB, USPT, USOC, EPAB, JPAB, DWPI, TDBD	ADJ	YES		03-14-2010
(least cost or bid or (cheap\$4 with carrier)) and (379/114.\$ccls. and packet with service)	PGPB, USPT, USOC, EPAB, JPAB, DWPI, TDBD	ADJ	YES		03-14-2010
(least cost or bid or (cheap\$4 with carrier) and 379/114.\$ccls. and packet with service) not (packet with service and 5675636)	PGPB, USPT, USOC, EPAB, JPAB, DWPI, TDBD	ADJ	YES		03-14-2010
6434380.pn.	PGPB, USPT, USOC, EPAB, JPAB, DWPI, TDBD	ADJ	YES		03-14-2010
7017015.pn.	PGPB, USPT, USOC, EPAB, JPAB, DWPI, TDBD	ADJ	YES		03-14-2010
7017050.pn.	PGPB, USPT, USOC, EPAB, JPAB, DWPI, TDBD	ADJ	YES		03-14-2010
SGSN or PLMN or RAT or TFT or QoS	PGPB, USPT, USOC, EPAB, JPAB, DWPI, TDBD	ADJ	YES		03-17-2010
370/352.ccls.	PGPB, USPT, USOC, EPAB, JPAB, DWPI, TDBD	ADJ	YES		03-17-2010
charg\$3 rule	PGPB, USPT, USOC, EPAB, JPAB, DWPI, TDBD	ADJ	YES		03-17-2010
(charg\$3 rule) and (370/352.ccls.) and (SGSN or PLMN or RAT or TFT or QoS)	PGPB, USPT, USOC, EPAB, JPAB, DWPI, TDBD	ADJ	YES		03-17-2010
6735177	PGPB, USPT, USOC, EPAB, JPAB, DWPI, TDBD	ADJ	YES		03-17-2010

(packet data or data packet) with service	PGPB, USPT, USOC, EPAB, JPAB, DWPI, TDBD	ADJ	YES		03-17-2010
((packet data or data packet) with service) and (SGSN or PLMN or RAT or TFT or QoS)	PGPB, USPT, USOC, EPAB, JPAB, DWPI, TDBD	ADJ	YES		03-17-2010
((packet data or data packet) with service and SGSN or PLMN or RAT or TFT or QoS) and (370/352.ccls.)	PGPB, USPT, USOC, EPAB, JPAB, DWPI, TDBD	ADJ	YES		03-17-2010
(packet data or data packet) with service provider	PGPB, USPT, USOC, EPAB, JPAB, DWPI, TDBD	ADJ	YES		03-17-2010
(SGSN or PLMN or RAT or TFT or QoS) and (370/352.ccls.) and ((packet data or data packet) with service provider)	PGPB, USPT, USOC, EPAB, JPAB, DWPI, TDBD	ADJ	YES		03-17-2010
379/114.01.ccls	PGPB, USPT, USOC, EPAB, JPAB, DWPI, TDBD	ADJ	YES		03-18-2010
379/114.01.ccls.	PGPB, USPT, USOC, EPAB, JPAB, DWPI, TDBD	ADJ	YES		03-18-2010
service provider	PGPB, USPT, USOC, EPAB, JPAB, DWPI, TDBD	ADJ	YES		03-18-2010
(service provider) and (379/114.01.ccls.)	PGPB, USPT, USOC, EPAB, JPAB, DWPI, TDBD	ADJ	YES		03-18-2010
data packet or packet data	PGPB, USPT, USOC, EPAB, JPAB, DWPI, TDBD	ADJ	YES		03-18-2010
(data packet or packet data) and (service provider and 379/114.01.ccls.)	PGPB, USPT, USOC, EPAB, JPAB, DWPI, TDBD	ADJ	YES		03-18-2010

charg\$3 or bill\$3 or pay\$4 or cost	PGPB, USPT, USOC, EPAB, JPAB, DWPI, TDBD	ADJ	YES		03-18-2010
(charg\$3 or bill\$3 or pay\$4 or cost) and (data packet or packet data and service provider and 379/114.01.ccls.)	PGPB, USPT, USOC, EPAB, JPAB, DWPI, TDBD	ADJ	YES		03-18-2010

INFORMATION DISCLOSURE STATEMENT BY APPLICANT

(Use as many sheets as necessary)

Complete if Known

Application Number	11/502,921
Filing Date	August 11, 2006
First Named Inventor	Xiaoqin Duan
Art Unit	2614
Examiner Name	Tieu, Binh Kien
Attorney Docket Number	11005.0219-00000

1 of 2

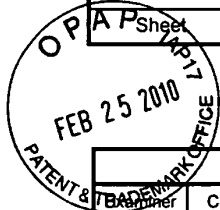

U.S. PATENTS AND PUBLISHED U.S. PATENT APPLICATIONS

Examiner Initials	Cite No. ¹	Document Number	Issue or Publication Date MM-DD-YYYY	Name of Patentee or Applicant of Cited Document	Pages, Columns, Lines, Where Relevant Passages or Relevant Figures Appear
		Number-Kind Code ² (if known)			
		US - 5,757,894 (A)	05-26-1998	Kay William	

Note: Submission of copies of U.S. Patents and published U.S. Patent Applications is not required.

FOREIGN PATENT DOCUMENTS

Examiner Initials	Cite No. ¹	Foreign Patent Document	Publication Date MM-DD-YYYY	Name of Patentee or Applicant of Cited Document	Pages, Columns, Lines, Where Relevant Passages or Relevant Figures Appear	Translation ⁶
		Country Code ³ Number ⁴ Kind Code ⁵ (if known)				
		CN 1303781 C	03-07-2007	HUAWEI TECHNOLOGIES CO. LTD [CN]		Abstract only
		CN 1222017 A	07-07-1999	IBM [US]		Abstract only
		CN 1444824 A	09-24-2003	NOKIA CORP [FI]		Abstract only
		CN 1452333 A	10-29-2003	HUAWEI TECHNOLOGIES CO. LTD [CN]		Abstract only
		CN 1472920 A	02-04-2004	HUAWEI TECHNOLOGIES CO. LTD [CN]		Abstract only

NONPATENT LITERATURE DOCUMENTS

Examiner Initials	Cite No. ¹	Include name of the author (in CAPITAL LETTERS), title of the article (when appropriate), title of the item (book, magazine, journal, serial, symposium, catalog, etc.), date, page(s), volume-issue number(s), publisher, city and/or country where published.	Translation ⁶
		European Official Communication pursuant to Article 94(3) EPC for Application No. 05738259.0, dated January 16, 2008.	
		Notice of Final Rejection - Official Action for Application No.: 2007-503178, dated December 15, 2009. Partial English Translation, 3 pages.	Yes
		Chinese Office Action in related Chinese Patent Application No.: 2004100337219, dated October 21, 2005, with English Translation	Yes

Title: Accounting and controlling method for grouped data service

Patent number: CN 1303781C

Grant date:2007-03-07

Inventor(s):DUAN XIAOQIN [CN] + (XIAOQIN DUAN)

Applicant(s):HUAWEI TECH CO LTD [CN] + (HUAWEI TECHNOLOGY CO., LTD)

Abstract of CN 1303781C

A method for controlling the charging of packet data service is disclosed, which includes: monitoring a plurality of event triggers; and sending a charging rule request from a Traffic Plane Function (TPF) to a Charging Rule Function (CRF), when one of said event trigger is met. In the present invention, the event triggers, which the TPF is required for request charging rules from the CRF according to are set by the CRF and then are provided to the TPF. Charging-relevant input information is provided in the request, based on which the CRF determines proper charging rules and sends the determined charging rules to the TPF.; In this way, the timing that the TPF requests charging rules from the CRF becomes controllable, and redundant information caused by the unnecessary charging rule from the TPF becomes avoidable, which enables interaction between the TPF and the CRF more effective and the charging control of packet data service reasonable and perfect.

[19] 中华人民共和国国家知识产权局

[51] Int. Cl.
H04L 12/14 (2006.01)



[12] 发明专利说明书

专利号 ZL 200410033721.9

[45] 授权公告日 2007年3月7日

[11] 授权公告号 CN 1303781C

[22] 申请日 2004.4.9
 [21] 申请号 200410033721.9
 [30] 优先权
 [32] 2004.4.1 [33] CN [31] 200410030955.8
 [73] 专利权人 华为技术有限公司
 地址 518129 广东省深圳市龙岗区坂田华为总部办公楼
 [72] 发明人 段小琴
 [56] 参考文献
 CN1444824A 2003.9.24
 CN1222017A 1997.7.7
 CN1452333A 2003.10.29
 CN1472920A 2004.2.4
 US5757894A 1998.5.26
 审查员 赵颖

[74] 专利代理机构 北京德琦知识产权代理有限公司
 代理人 宋志强 麻海明

权利要求书 2 页 说明书 17 页 附图 6 页

[54] 发明名称
 一种分组数据业务的计费控制方法

[57] 摘要
 本发明公开了一种分组数据业务的计费控制方法，该方法包含：设置触发事件点；触发事件点发生时，TPF 向 CRF 发送计费规则请求。本发明中，由 CRF 确定需要 TPF 向其请求计费规则的触发事件点，然后向 TPF 下发这些触发事件点，当触发事件点发生时，TPF 向 CRF 请求计费规则并提供计费相关输入信息，CRF 根据计费相关输入信息选择适当的计费规则，并向 TPF 下发选定的计费规则，这样，可实现 CRF 对 TPF 向其请求计费规则的时机进行控制，避免了由于 TPF 在不必要的时候向 CRF 请求计费规则而导致的冗余信息，使得 TPF 与 CRF 之间的信息交互更为有效，对于分组数据业务计费的控制更为合理完善。

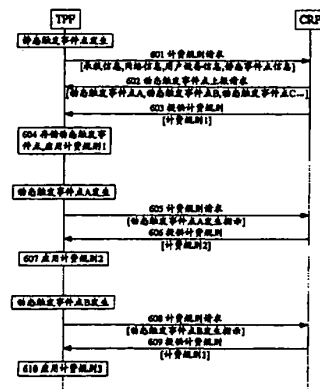

- 1、一种分组数据业务的计费控制方法，其特征在于，该方法包含以下步骤：
 - A、计费规则功能实体 CRF 收到计费相关输入信息后，设置动态触发事件点并发送给传输面功能实体 TPF；
 - B、所设置的动态触发事件点发生时，TPF 向基于业务数据流计费的 CRF 发送对应于动态触发事件点的计费规则请求。
- 2、根据权利要求 1 所述的方法，其特征在于，步骤 A 之前进一步包括：
 - A0、在 TPF 中配置静态触发事件点，所述静态触发事件点发生时，TPF 向 CRF 发送对应于静态触发事件点的计费规则请求；则步骤 A 中所述收到计费相关输入信息为：CRF 收到 TPF 发来的计费规则请求。
- 3、根据权利要求 2 所述的方法，其特征在于，所述静态触发事件点发生之前进一步包括：TPF 监测所述静态触发事件点的发生。
- 4、根据权利要求 2 所述的方法，其特征在于，步骤 A0 中所述计费规则请求中携带有用于标明静态触发事件点的事件标识。
- 5、根据权利要求 2 所述的方法，其特征在于，所述步骤 A0 之后进一步包括：CRF 向 TPF 提供计费规则。
- 6、根据权利要求 1 所述的方法，其特征在于，所述步骤 B 之前进一步包括：TPF 存储所述动态触发事件点，并监测所述动态触发事件点的发生。
- 7、根据权利要求 1 所述的方法，其特征在于，步骤 B 中所述计费规则请求中携带有用于标明动态触发事件点的事件标识。
- 8、根据权利要求 1 所述的方法，其特征在于，所述步骤 B 之后进一步包括：CRF 向 TPF 提供计费规则。
- 9、根据权利要求 8 所述的方法，其特征在于，所述 CRF 向 TPF 提供的计费规则是：CRF 根据发生的动态触发事件点确定的。
- 10、根据权利要求 1 所述的方法，其特征在于，所述动态触发事件点为 CRF

根据自身存储信息进行设置。

11、根据权利要求1所述的方法，其特征在于，所述动态触发事件点为 CRF 根据应用功能实体 AF，或在线计费系统 OCS，或 TPF，或以上所述任意组合提供的计费相关输入信息设置。

一种分组数据业务的计费控制方法

技术领域

本发明涉及计费领域，特别是指一种分组数据业务的计费控制方法。

背景技术

随着分组数据业务应用的逐渐广泛，如何准确合理地对分组数据业务进行计费，已成为运营商普遍关注的问题。

图1为分组数据协议上下文(PDP Context, Packet Data Protocol Context)激活、传输数据、去激活流程图，如图1所示，在通用分组无线业务(GPRS, General Packet Radio Service)中，PDP Context激活、传输数据、去激活的实现过程包括以下步骤：

步骤101：用户设备(UE)向服务通用分组无线业务支持节点(SGSN, Serving GPRS Support Node)发送PDP Context激活请求(Activate PDP Context Request)，该Activate PDP Context Request中携带有网络层业务访问标识(NSAPI, Network Layer Service Access Point Identifier)、PDP类型、接入点名称(APN, Access Point Name)、要求的服务质量(QoS)参数、事务标识(TI, Transaction Identifier)等信息，其中，NSAPI在SGSN和网关通用分组无线业务支持节点(GGSN, Gateway GPRS Support Node)之间作为隧道标识(TEID, Tunnel Identifier)的组成部分，用于标识PDP Context；PDP类型包括端对端协议(PPP, Peer-Peer Protocol)类型、网际协议(IP, Internet Protocol)类型等；APN可由UE向SGSN提供，SGSN根据APN寻址到相应GGSN，GGSN根据APN确定UE所要访问的外部网络，UE也可不向SGSN提供APN，此时，由SGSN根据UE用户的签约信息选择缺省的APN；QoS参数为UE指定的分组数据业务所要达到的质量要求；TI用于

UE 标识一个 PDP context。

步骤 102: SGSN 收到 Activate PDP Context Request 后, 与 UE 进行安全性检查和加密, 该步骤为可选步骤。

步骤 103: SGSN 根据 APN 解析 GGSN 地址信息, 如果 SGSN 能够根据 APN 解析出 GGSN 的地址信息, 则为 PDP Context 创建 TEID, 该 TEID 可为国际移动用户标识 (IMSI, International Mobile Subscriber Identity) 与 NSAPI 的组合, 用于在 SGSN 和 GGSN 之间唯一标识一个 PDP Context, 然后 SGSN 向 GGSN 发送 PDP Context 创建请求 (Create PDP Context Request), 该 Create PDP Context Request 中携带有 PDP 类型、PDP 地址、APN、QoS 参数、TEID、选择模式等, 其中, PDP 地址为 UE 的 IP 地址, 为可选参数, Create PDP Context Request 可不携带 PDP 地址, 此时, 在后续的处理过程中, 可由 GGSN 为 UE 分配 IP 地址, 也可由最终与 UE 建立连接的分组数据网络 (PDN, Packet Data Network) 为 UE 分配 IP 地址; 选择模式是指 APN 的选择模式, 即 APN 是由 UE 选定的还是由 SGSN 选定的。如果 SGSN 无法根据 APN 解析出 GGSN 的地址信息, 则 SGSN 拒绝 UE 发起的 PDP Context 激活请求。

步骤 104: GGSN 收到 Create PDP Context Request 后, 根据 APN 确定外部 PDN, 然后分配计费标识 (Charging ID)、启动计费, 并且协商 QoS, 如果 GGSN 能够满足 QoS 参数的服务质量要求, 则向 SGSN 返回 PDP Context 创建响应 (Create PDP Context Response), 该 Create PDP Context Response 中携带有 TEID、PDP 地址、链路承载 (Backbone Bearer) 协议、QoS 参数、Charging ID 等信息。如果 GGSN 无法满足 QoS 参数的服务质量要求, 则 GGSN 拒绝 SGSN 发起的 PDP Context 创建请求, 然后 SGSN 拒绝 UE 发起的 PDP Context 激活请求。

步骤 105: SGSN 收到 Create PDP Context Response 后, 在 PDP Context 中插入 NSAPI 和 GGSN 地址信息, 用于标识该 PDP Context, 并根据 QoS

参数选择无线优先权，然后向 UE 返回 PDP Context 激活响应 (Activate PDP Context Accept)，该 Activate PDP Context Accept 中携带有 PDP 类型、PDP 地址、TI、QoS 参数、无线优先权、PDP 配置选项等信息。并且，SGSN 启动计费。UE 收到 Activate PDP Context Accept，建立与 GGSN 之间的路由，此时，UE 与 PDN 建立了传输通道，可以进行数据传输了。

步骤 106: UE 通过 SGSN、GGSN 与 PDN 进行数据传输。

步骤 107: 数据传输完毕，UE 向 SGSN 发送 PDP Context 去激活请求 (Deactivate PDP Context Request)，该 Deactivate PDP Context Request 中携带有 TI。

步骤 108: SGSN 收到 Deactivate PDP Context Request 后，与 UE 进行安全性检查和加密，该步骤为可选步骤。

步骤 109~步骤 111: SGSN 向 GGSN 发送 PDP Context 删除请求 (Delete PDP Context Request)，该 Delete PDP Context Request 中携带有 TEID。GGSN 收到 Delete PDP Context Request 后，结束对 UE 的计费，删除对应于 TEID 的 PDP Context，然后向 SGSN 发送 PDP Context 删除响应 (Delete PDP Context Response)，该 Delete PDP Context Response 中携带有 TEID。SGSN 收到 Delete PDP Context Response 后，结束对 UE 的计费，删除对应于 TEID 的 PDP Context，然后向 UE 发送 PDP Context 去激活响应 (Deactivate PDP Context Response)，该 Deactivate PDP Context Response 中携带有 TI。UE 收到 Deactivate PDP Context Response 后，删除对应于 TI 的 PDP Context。

由图 1 描述的流程可见，当前的 GPRS 计费系统中，由于计费的起始点设置在 PDP Context 激活时，计费的终止点设置在 PDP Context 删除时，因此只能根据 PDP Context 传输的数据流量进行计费，或是根据 PDP Context 处于激活状态的时间长度进行计费。然而，在实际应用中，UE 与 PDN 建立起传输通道后，该 UE 可以基于一个激活的 PDP Context 进行多种业务，即如果 PDN 能够提供多种业务，如电子邮件 (Email) 收发业务、基于无线应

用协议的 (WAP, Wireless Application Protocol) 的浏览业务、基于文件传输协议 (FTP, File Transfer Protocol) 的文件传输等业务, 则 UE 在与该 PDN 建立传输通道后, 可通过一个激活的 PDP Context 承载该 PDN 能够提供的各种业务, 但是, 运营商对于各种业务的计费模式很可能采用不同的计费方式, 如对于 Email 收发业务可基于 Email 接收和发送事件的触发按次计费, 对于 WAP 浏览业务可根据流量计费, 对于文件传输业务也可根据流量计费, WAP 浏览业务的费率与文件传输业务的费率却不尽相同。这样, 根据现有的 GPRS 计费系统, 根本无法对同一 PDP Context 承载的不同业务进行区分计费。

针对上述情况, 第三代合作伙伴计划 (3GPP, The 3rd Generation Partnership Project) 目前正在讨论如何实现基于 IP 数据流的计费 (FBC, Flow Based Charging)。对于一个分组数据业务而言, UE 的用户使用该业务时, 传输和接收到的所有 IP 数据流 (IP Flow), 也可为 IP 分组包 (IP packet), 总称为业务数据流 (Service Data Flow), 即业务数据流是多个 IP 数据流组成的集合, 因此基于 IP 数据流的计费能够真实反映某个业务数据流对资源的占用情况。基于 IP 数据流的计费可被认为是通过一些类似筛子的过滤器将同一 PDP Context 中承载的不同业务的 IP 数据流分别筛选出来, 然后针对不同过滤器过滤出的 IP 数据流进行分别计费, 以达到对不同的业务数据流分别计费的目的。这样, 基于 IP 数据流的计费粒度要远远小于基于一个 PDP Context 的计费粒度, 粒度可看作是筛子孔的大小, 基于一个 PDP Context 的计费粒度是一个 PDP Context 就是一个筛子孔, 而基于 IP 数据流的计费粒度则是一个 IP 业务数据流则为一个筛子孔, 即针对一个 PDP Context 中包含多个筛子孔, 因此, 基于 IP 数据流的计费与比基于一个 PDP Context 的计费相比, 基于 IP 数据流的计费能够为运营商或业务提供者提供更为丰富的计费手段。

3GPP 中对 FBC 的系统结构、功能要求以及消息交互流程等方面均进行

了描述,支持在线计费的FBC系统结构如图2A所示,基于移动网络增强逻辑的客户化应用(CAMEL, Customised Application for Mobile Network Enhanced Logic)的业务控制点(SCP, Service Control Point)201和基于业务数据流计费的信用控制功能实体(CCF, Service Data Flow Based Credit Control Function)202组成了在线计费系统(OCS, Online Charging System)206。CCF 202通过Ry接口与基于业务数据流计费的计费规则功能实体(CRF, Service Data Flow Based Charging Rule Function)203相连,CRF 203通过Rx接口与应用功能实体(AF, Application Function)204相连,CRF 203通过Gx接口与传输面功能实体(TPF, Traffic Plane Function)205相连,CCF 202通过Gy接口与TPF 205相连。

支持离线计费的FBC系统结构如图2B所示,CRF 203通过Rx接口与AF 204相连,CRF 203通过Gx接口与TPF 205相连,TPF 205通过Gz接口分别与计费网关功能实体(CGF, Charging Gateway Function)207和计费采集功能实体(CCF, Charging Collection Function)208相连。

根据目前3GPP对于实现FBC功能实体的划分,TPF 205承载IP数据流,当IP数据流的承载建立时,TPF 205通过Gx接口向CRF 203发送计费规则请求,该计费规则请求中携带有与用户和UE相关的信息、承载特性以及与网络相关的信息等,其中与用户和UE相关的信息可为移动台国际号码(MSISDN)、国际移动用户标识(IMSI)等,与网络相关的信息可为移动网络编码(MNC)、移动国家码(MCC)等。另外,由于在IP数据流传输过程中,会对承载进行修改,如对QoS参数进行重新协商,当用户使用同一业务的QoS参数不同时,计费规则可能不同,如QoS参数下降相应的费率也下降。此时,TPF 205可在承载修改时,重新向CRF203发送计费规则请求,请求新的计费规则;CRF 203根据TPF 205提供的上述输入信息选择适当的计费规则,并向TPF 205返回选定的计费规则,计费规则中包括计费机制、计费类型、计费键、业务数据流过滤器、计费规则优先级等信息。其

中，计费机制可为采用在线计费还是离线计费；计费类型可为基于时间长度进行计费还是基于数据流量进行计费；计费键是与计费费率相关的参数，CRF 203 可不直接向 TPF 205 提供计费费率，而只是向 TPF 205 提供与计费费率相关的参数；业务数据过滤器用于指示 TPF 205 对哪些 IP 数据流进行过滤，然后 TPF 205 根据计费规则对过滤出的 IP 数据流进行计费。业务数据过滤器可包含 IP5 元组，IP5 元组可包括源/目的 IP 地址、源/目的端口号 (Port Number)、协议标识 (Protocol ID) 等信息，例如，CRF 203 指示 TPF 205 对源地址为 10.0.0.1、目的地址为 10.0.0.2、源/目的端口号为 20、协议类型为传输控制协议 (TCP) 的 IP 数据流进行过滤，并根据计费规则对过滤出的 IP 数据流进行计费。最后，当承载删除时，TPF 205 也可向 CRF 203 发送计费规则请求，要求 CRF 提供新的计费规则，此时 CRF 203 可要求 TPF 205 删除先前建立的计费规则。

另外，CRF 203 除了根据 TPF 205 的输入信息确定计费规则之外，CRF 203 还可根据 AF 204 或 OCS 206 的输入信息确定计费规则，如 AF 204 通知 CRF 203 用户当前使用的业务类型，CRF 203 根据该业务类型选取相应的计费规则。

对应于 GPRS 网络，TPF 205 为 GGSN，AF 为 PDN 中的一个业务网关或业务服务器，CRF 203 为新增的逻辑实体。TPF 205 为计费规则的执行点，CRF 203 为计费规则的控制点。

图 3A 为承载建立时下发计费规则流程图，如图 3A 所示，承载建立时下发计费规则的实现过程包括以下步骤：

步骤 301A: UE 向 TPF 发送承载建立请求 (Establish Bearer Service Request)，在 GPRS 网络中，则是 GGSN 收到 Create PDP Context Request。

步骤 302A: TPF 收到承载建立请求后，向 CRF 发送计费规则请求 (Request Charging Rules)，该计费规则请求中携带有供 CRF 确定计费规则的输入信息。

步骤 303A~步骤 304A: CRF 收到计费规则请求后, 根据该计费规则请求中携带的输入信息选取计费规则, 然后向 TPF 返回提供计费规则 (Provision Charging Rules), 该提供计费规则中可携带有选定的计费规则。

步骤 305A~步骤 306A: TPF 收到提供计费规则后, 根据 CRF 选定的计费规则, 建立新的计费规则, 或是删除原有的计费规则, 或是删除原有计费规则的同时建立新的计费规则, 然后向 UE 返回承载建立响应 (Establish Bearer Service Accept), 接受 UE 发起的承载建立请求, 并继续后续的承载建立流程。

图 3B 为承载修改时下发计费规则流程图, 如图 3A 所示, 承载修改时下发计费规则的实现过程包括以下步骤:

步骤 301B: UE 向 TPF 发送承载修改请求 (Modify Bearer Service Request), 在 GPRS 网络中, 则是 GGSN 收到 PDP Context 更新请求 (Update PDP Context Request)。

步骤 302B: TPF 收到承载修改请求后, 向 CRF 发送计费规则请求, 该计费规则请求中携带有供 CRF 确定计费规则的输入信息。

步骤 303B~步骤 304B: CRF 收到计费规则请求后, 根据该计费规则请求中携带的输入信息选取计费规则, 然后向 TPF 返回提供计费规则, 该提供计费规则中可携带有选定的计费规则。

步骤 305B~步骤 306B: TPF 收到提供计费规则后, 根据 CRF 选定的计费规则, 建立新的计费规则, 或是删除原有的计费规则, 或是删除原有计费规则的同时建立新的计费规则, 然后向 UE 返回承载修改响应 (Modify Bearer Service Accept), 接受 UE 发起的承载修改请求, 并继续后续的承载修改流程。

图 3C 为承载删除时下发计费规则流程图, 如图 3A 所示, 承载删除时下发计费规则的实现过程包括以下步骤:

步骤 301C: UE 向 TPF 发送承载删除请求 (Remove Bearer Service

Request)，在 GPRS 网络中，则是 GGSN 收到 Delete PDP Context Request。

步骤 302C: TPF 收到承载删除请求后，向 CRF 发送计费规则请求，该计费规则请求中携带有供 CRF 确定计费规则的输入信息。

步骤 303C~步骤 304C: CRF 收到计费规则请求后，根据该计费规则请求中携带的输入信息选取计费规则，然后向 TPF 返回提供计费规则，该提供计费规则中可携带有选定的计费规则。

步骤 305C~步骤 306C: TPF 收到提供计费规则后，根据 CRF 选定的计费规则，建立新的计费规则，或是删除原有的计费规则，或是删除原有计费规则的同时建立新的计费规则，然后向 UE 返回承载删除响应 (Remove Bearer Service Accept)，接受 UE 发起的承载删除请求，并继续后续的承载删除流程。

另外，对于 CRF 也可主动向 TPF 发送计费规则，如当 UE 与 AF 进行业务数据传输的过程中，CRF 收到 AF 的计费相关输入信息后，根据 AF 提供的输入信息选择适当的计费规则，然后主动向 TPF 下发选定的计费规则。对于 AF 向 CRF 提供计费输入信息的具体实现过程如图 4 所示：

步骤 401: AF 向 CRF 发送应用/业务计费相关信息 (Send Application/Service Data Flow Charging Information)。

步骤 402: CRF 收到应用/业务计费相关信息后，向 AF 返回响应 (Ack)，通知 AF 已收到其发送的计费相关输入信息。

图 5 为 CRF 主动向 TPF 下发计费规则流程图，如图 5 所示，CRF 主动向 TPF 下发计费规则的实现过程包括以下步骤：

步骤 501: CRF 收到某个内部或外部的触发事件 (Internal or External Trigger Event)，以及与该事件相关的信息，如 AF 向 CRF 发送计费规则选择输入信息的事件。

步骤 502: CRF 根据获取的信息选择相应的计费规则。这些信息可为 AF 提供的计费相关输入信息，例如，用户使用 AF 提供的某一业务，该业

务对计费有特殊要求，如计费费率与其他业务的计费费率不同，因此，AF 向 CRF 提供与该业务相关的计费信息；也可为 TPF 提供的计费相关输入信息。

步骤 503: 如果需要的话，CRF 向 TPF 发送提供计费规则，该提供计费规则中可携带有选定的计费规则。

步骤 504: TPF 收到提供计费规则后，根据 CRF 选定的计费规则，建立新的计费规则，或是删除原有的计费规则，或是删除原有计费规则的同时建立新的计费规则。

对于目前 3GPP 规范中定义的 TPF 与 CRF 关于计费规则的交互方式是：在一定的触发事件发生时，如承载需要建立、修改或删除时，TPF 向 CRF 发送计费规则请求，CRF 根据计费规则请求中携带的信息选择适当的计费规则，并向 TPF 下发选定的计费规则。这样，请求计费规则的事件点是由 TPF 进行控制的，在 TPF 中预先配置请求计费规则的事件点，如设置请求计费规则的事件点为当承载建立、修改以及删除时，均需要 TPF 向 CRF 请求计费规则。但是，对于一些情况下，当承载修改时，如修改 QoS 参数时，修改后的 QoS 参数与原有的 QoS 参数相差不大，还没有达到需要修改计费规则的级别，如果此时 TPF 仍然向 CRF 请求计费规则，则 CRF 会选择一个原计费规则相同的计费规则下发给 TPF，这样，必然导致 TPF 与 CRF 之间生成大量冗余信息。

由以上描述可见，在 3GPP 规范中，CRF 虽然是计费规则的控制点，却并不能够实现对计费的完全控制。

发明内容

有鉴于此，本发明的目的在于提供一种分组数据业务的计费控制方法，使得对分组数据业务计费的控制更为合理完善。

为了达到上述目的，本发明提供了一种分组数据业务的计费控制方法，该方法包含：

A、CRF 收到计费相关输入信息后,设置动态触发事件点并发送给 TPF;

B、所设置的动态触发事件点发生时,TPF 向 CRF 发送对应于动态触发事件点的计费规则请求。

所述步骤 A 之前进一步包括: A0、在 TPF 中配置静态触发事件点,所述静态触发事件点发生时,TPF 向 CRF 发送对应于静态触发事件点的计费规则请求;则步骤 A 中所述收到计费相关输入信息为:CRF 收到 TPF 发来的计费规则请求。

所述静态触发事件点发生之前进一步包括:TPF 监测所述静态触发事件点的发生。步骤 A0 中所述计费规则请求中携带有用于标明静态触发事件点的事件标识。所述步骤 A0 之后进一步包括:CRF 向 TPF 提供计费规则。

所述步骤 B 之前进一步包括:TPF 存储所述动态触发事件点,并监测所述动态触发事件点的发生。步骤 B 中所述计费规则请求中携带有用于标明动态触发事件点的事件标识。

所述步骤 B 之后进一步包括:CRF 向 TPF 提供计费规则。其中,所述 CRF 向 TPF 提供计费规则为:CRF 根据发生的动态触发事件点选择适当的计费规则,然后向 TPF 提供选定的计费规则。

所述触发事件点为 CRF 根据自身存储信息进行设置。所述触发事件点为 CRF 根据 AF,或 OCS,或 TPF,或以上所述任意组合提供的计费相关输入信息设置。

本发明中,由 CRF 确定需要 TPF 向其请求计费规则的触发事件点,然后向 TPF 下发这些触发事件点,当触发事件点发生时,TPF 向 CRF 请求计费规则并提供计费相关输入信息,CRF 根据计费相关输入信息选择适当的计费规则,并向 TPF 下发选定的计费规则,这样,可实现 CRF 对 TPF 向其请求计费规则的时机进行控制,避免了由于 TPF 在不必要的时候向 CRF 请求计费规则而导致的冗余信息,使得 TPF 与 CRF 之间的信息交互更为有效,对于分组数据业务计费的控制更为合理完善。

另外,由于 CRF 能够获取 AF 或 OCS 提供的计费相关输入信息,这些

计费相关输入信息可能对计费规则产生影响,根据本发明提出的方法,CRF可根据这些计费相关输入信息灵活设置触发事件点,然后向 TPF 下发当前设置的触发事件点,使得 TPF 能够在满足一定条件时,即触发事件点发生时,向 CRF 请求新的计费规则,这样,使得计费规则的应用更为灵活丰富,这些功能通过现有 TPF 与 CRF 的交互是根本无法实现的。

附图说明

- 图 1 为 PDP Context 激活、传输数据、去激活流程图;
- 图 2A 为在线计费的 FBC 系统结构示意图;
- 图 2B 为离线计费的 FBC 系统结构示意图;
- 图 3A 为承载建立时下发计费规则流程图;
- 图 3B 为承载修改时下发计费规则流程图;
- 图 3C 为承载删除时下发计费规则流程图;
- 图 4 为 AF 向 CRF 提供计费输入信息流程图;
- 图 5 为 CRF 主动向 TPF 下发计费规则流程图;
- 图 6 为本发明中 CRF 控制 TPF 发送计费规则请求流程图;
- 图 7 为本发明中实施例一示意图;
- 图 8 为本发明中实施例二示意图。

具体实施方式

为使本发明的目的、技术方案和优点更加清楚,下面结合附图对本发明作进一步的详细描述。

本发明中,由 CRF 确定需要 TPF 向其请求计费规则的触发事件点,然后向 TPF 下发这些触发事件点,当触发事件点发生时,TPF 向 CRF 请求计费规则并提供计费相关输入信息,CRF 根据计费相关输入信息选择适当的计费规则,并向 TPF 下发选定的计费规则。这样,CRF 可根据计费规则、计费模式灵活设置触发事件点,实现 CRF 对计费的完全控制,使得 TPF 能够

有效地向 CRF 请求计费规则，避免了 TPF 与 CRF 之间冗余信息的生成。

图 6 为本发明中 CRF 控制 TPF 发送计费规则请求流程图，如图 6 所示，CRF 控制 TPF 发送计费规则请求的实现过程包括以下步骤：

步骤 601：在 TPF 中配置向 CRF 请求计费规则的静态触发事件点，如承载建立，当静态触发事件点发生时，TPF 向 CRF 发送计费规则请求，该计费规则请求中携带有计费相关输入信息，如与用户和 UE 相关的信息、承载特性以及与网络相关的信息等；该计费规则请求中还可携带有事件标识，用于指示当前计费规则请求为静态触发事件点触发的。

另外，可在 TPF 中配置多个静态触发事件点，如承载建立、承载删除等，当其中一个静态触发事件点发生时，TPF 向 CRF 请求计费规则。

步骤 602：CRF 收到计费规则请求后，设置要求 TPF 请求计费规则的动态触发事件点，然后向 TPF 发送动态触发事件点上报请求，该动态触发事件点上报请求中携带有设置的动态触发事件点列表，动态触发事件点 A、动态触发事件点 B、动态触发事件点 C 等等，可为承载修改、划分的 QoS 参数修改的不同级别段、承载删除等动态触发事件点，例如 SGSN 变化、公用陆地移动通信网络 (PLMN) 变化、无线接入技术 (RAT) 类型变化、传输流模板 (TFT) 变化、QoS 变化等不同的承载修改事件。

步骤 603：CRF 根据计费规则请求中携带的计费相关输入信息，选择适当的计费规则，然后向 TPF 发送提供计费规则，该提供计费规则中可携带有选定的计费规则，如计费规则 1。

这里，步骤 602 和步骤 603 中 CRF 向 TPF 发送的各信息可通过一条消息承载。

步骤 604：TPF 收到动态事件点列表和 CRF 当前选定的计费规则后，存储动态触发事件点列表，根据该计费规则进行计费信息统计，并监测动态触发事件点的发生。

步骤 605：TPF 监测到动态触发事件点 A 发生，向 CRF 发送计费规则

请求，该计费规则请求中携带有动态触发事件点 A 发生指示。

步骤 606: CRF 收到计费规则请求后，根据动态触发事件点 A 发生指示确定该计费规则请求是由动态触发事件点 A 触发的，并根据动态触发事件点 A 选择适当的计费规则，然后向 TPF 发送提供计费规则，该提供计费规则中可携带有选定的新的计费规则，如计费规则 2。

步骤 607: TPF 收到提供计费规则后，根据该计费规则进行计费信息统计。

如果有多个动态触发事件点，则 TPF 继续监测其余的动态触发事件点的发生。

步骤 608: TPF 监测到动态触发事件点 B 发生，向 CRF 发送计费规则请求，该计费规则请求中携带有动态触发事件点 B 发生指示。

步骤 609: CRF 收到计费规则请求后，根据动态触发事件点 B 发生指示确定该计费规则请求是由动态触发事件点 B 触发的，并根据动态触发事件点 B 选择适当的计费规则，然后向 TPF 发送提供计费规则，该提供计费规则中可携带有选定的新的计费规则，如计费规则 3。

步骤 610: TPF 收到提供计费规则后，根据该计费规则进行计费信息统计。

后续流程与上述流程相似，不再赘述。

另外，在同一个会话中，对于 GPRS 网络，同一个会话即为同一个 PDP Context，CRF 可多次设置动态触发事件点并发送给 TPF。例如，CRF 收到 AF 或是 OCS 的计费相关输入信息时，可根据计费相关输入信息确定是否需要设置新的动态触发事件点，如果是，则设置新的动态触发事件点并发送给 TPF，TPF 收到新的动态触发事件点后，存储新的动态触发事件点并监测动态触发事件点的发生。

另外，由于在 TPF 中可配置向 CRF 请求计费规则的静态触发事件点，对于一些比较固化的事件，如承载建立，承载 QoS 修改，流量或者时间长

度到达某一个固定的值, 承载删除等等, 可直接通过在 TPF 中预先配置静态事件点来向 CRF 上报承载的变化信息。而不需要 CRF 向 TPF 下发动态事件点。对于一些运营商或业务提供商对承载变化的事件很固定, 如总是要求业务流量达到 10M 时 TPF 向 CRF 上报, 或是总是要求业务激活时长达到 100 分钟后 TPF 向 CRF 上报, 而没有其它需要动态配置的事件点, 这样, 只在 TPF 中预先配置相应的静态事件点就可以实现, CRF 不下发任何动态事件点, 可以减轻 TPF 和 CRF 之间的信令负荷。

图 7 为本发明中实施例一示意图, 本实施例中将 TPF 向 CRF 请求计费规则的静态触发事件点设置为承载建立, CRF 将需要 TPF 向其请求计费规则的动态触发事件点设置为承载修改和承载删除, CRF 控制 TPF 发送计费规则请求的实现过程包括以下步骤:

步骤 701: UE 向 TPF 发送承载建立请求, 在 GPRS 网络中, 则是 GGSN 收到 Create PDP Context Request.

步骤 702: TPF 收到承载建立请求后, 确定静态触发事件点已发生, 然后向 CRF 发送计费规则请求, 该计费规则请求中携带有计费相关输入信息, 如与用户和 UE 相关的信息、承载特性以及与网络相关的信息等; 该计费规则请求中还可携带有事件标识, 用于指示当前计费规则请求为静态触发事件点触发的。

步骤 703~步骤 704: CRF 收到计费规则请求后, 根据事件标识确定该计费规则请求是由静态触发事件点触发的, 然后设置动态触发事件点列表包括承载修改和承载删除, 并向 TPF 发送动态触发事件点上报请求 (Request Dynamic Event Report), 该动态触发事件点上报请求中携带有动态触发事件点列表。另外, CRF 还可在承载修改的动态触发事件点中设置多个不同的值, 如不同的 QoS 参数级别, 每个值均可作为一个独立的动态触发事件点。

步骤 705~步骤 706: CRF 根据计费规则请求中携带的计费相关输入信息选择适当的计费规则, 然后向 TPF 发送提供计费规则 (Charging Rule

Response)，该提供计费规则中可携带有选定的计费规则。

步骤 707~步骤 708: TPF 收到 CRF 设置的动态触发事件点列表和 CRF 选定的计费规则后，存储动态触发事件点列表，根据计费规则进行计费信息统计，并监测动态触发事件点的发生。TPF 向 UE 返回承载建立响应，接受 UE 发起的承载建立请求，并继续后续的承载建立流程。

步骤 709: 一段时间后，UE 向 TPF 发送承载修改请求，在 GPRS 网络中，则是 GGSN 收到 Update PDP Context Request。

步骤 710: TPF 收到承载修改请求后，确定动态触发事件点列表中的动态触发事件点承载修改已发生，然后向 CRF 发送计费规则请求，该计费规则请求中携带有动态触发事件点发生指示。

步骤 711~步骤 712: CRF 收到计费规则请求后，根据动态触发事件点发生指示确定该计费规则请求是由动态触发事件点承载修改触发的，并根据承载修改选择适当的计费规则，然后向 TPF 发送提供计费规则，该提供计费规则中可携带有选定的计费规则。

步骤 713~步骤 714: TPF 收到提供计费规则后，根据 CRF 选定的计费规则，建立新的计费规则，或是删除原有的计费规则，或是删除原有计费规则的同时建立新的计费规则，然后向 UE 返回承载修改响应，接受 UE 发起的承载修改请求，并继续后续的承载修改流程。

步骤 715: 一段时间后，UE 向 TPF 发送承载删除请求，在 GPRS 网络中，则是 GGSN 收到 Delete PDP Context Request。

步骤 716: TPF 收到承载删除请求后，确定动态触发事件点列表中的动态触发事件点承载删除已发生，然后向 CRF 发送计费规则请求，该计费规则请求中携带有动态触发事件点发生指示。

步骤 717~步骤 718: CRF 收到计费规则请求后，根据动态触发事件点发生指示确定该计费规则请求是由动态触发事件点承载删除触发的，并根据承载删除选择适当的计费规则，然后向 TPF 发送提供计费规则，该提供计

费规则中可携带有选定的计费规则。

步骤 719~步骤 720: TPF 收到提供计费规则后, 根据 CRF 选定的计费规则, 建立新的计费规则, 或是删除原有的计费规则, 或是删除原有计费规则的同时建立新的计费规则, 然后向 UE 返回承载删除响应, 接受 UE 发起的承载删除请求, 并继续后续的承载删除流程。

现有技术中, AF 可向 CRF 发送应用/业务计费相关信息, 作为 CRF 选择计费规则的计费相关输入信息; 那么, 根据本发明提出的方法, AF 可向 CRF 发送应用/业务计费相关信息, 作为 CRF 动态设置动态触发事件点的输入信息。

图 8 为本发明中实施例二示意图, 如图 8 所示, 本实施例中, CRF 向 TPF 下发动态触发事件点的实现过程包括以下步骤:

步骤 801: CRF 收到某个内部或外部的触发事件, 如 AF 为用户提供积分活动, 如果用户访问该 AF 的某个业务的数据流量达到一定数值, 则这个用户访问该业务的后续计费费率将降低, 此时, AF 要求 CRF 在某个业务过滤器的数据流量达到一定值时, 采用优惠的计费费率对后续的数据流量进行计费信息统计, 或如果用户访问该 AF 的某个业务的使用时间长度达到一定数值, 则这个用户访问该业务的后续计费费率将降低, 此时, AF 要求 CRF 在某个业务过滤器的使用时间长度达到一定值时, 采用优惠的计费费率对后续的数据流量进行计费信息统计。

步骤 802: CRF 配置动态触发事件点, 例如, 设置动态触发事件点为某个业务过滤器的数据流量达到一定值, 或设置动态触发事件点为某个业务过滤器的业务使用时间长度达到一定值。另外, CRF 可根据当前获知的信息, 如 TPF 提供的用户/终端信息, 承载特性, 网络相关信息等选择适当的计费规则。

步骤 803: CRF 向 TPF 发送动态触发事件点上报请求, 该动态触发事件点上报请求中携带有当前设置的动态触发事件点列表, 要求 TPF 在动态触

发事件点发生时，向其请求计费规则。

步骤 804: CRF 向 TPF 发送提供计费规则，该提供计费规则中可携带有当前选定的计费规则，该步骤为可选步骤。

步骤 805: TPF 收到 CRF 当前设置的动态触发事件点列表，存储该动态触发事件点列表。如果 TPF 还收到提供计费规则，则根据 CRF 选定的计费规则，建立新的计费规则，或是删除原有的计费规则，或是删除原有计费规则的同时建立新的计费规则。

步骤 806: 一段时间后，TPF 监测到动态触发事件点发生，向 CRF 发送计费规则请求，该计费规则请求中携带有动态触发事件点发生指示。

步骤 807~步骤 808: CRF 收到计费规则请求后，根据动态触发事件点发生指示可确定该计费规则请求是由哪一个动态触发事件点触发的，例如，某个业务过滤器的数据流量已经达到一定值，或某个业务过滤器的业务使用时间长度已经达到一定值，并根据该动态触发事件点选择适当的计费规则，然后向 TPF 发送提供计费规则，该提供计费规则中可携带有选定的计费规则。

步骤 809: TPF 收到提供计费规则后，根据 CRF 选定的计费规则，建立新的计费规则，或是删除原有的计费规则，或是删除原有计费规则的同时建立新的计费规则。

另外，CRF 也可根据 OCS 发送的与用户信用相关的计费相关输入信息，对动态触发事件点进行动态设置，相应的流程与上述流程基本相同，在此不再赘述。

总之，以上所述仅为本发明的较佳实施例而已，并非用于限定本发明的保护范围。



图 1



图 2A

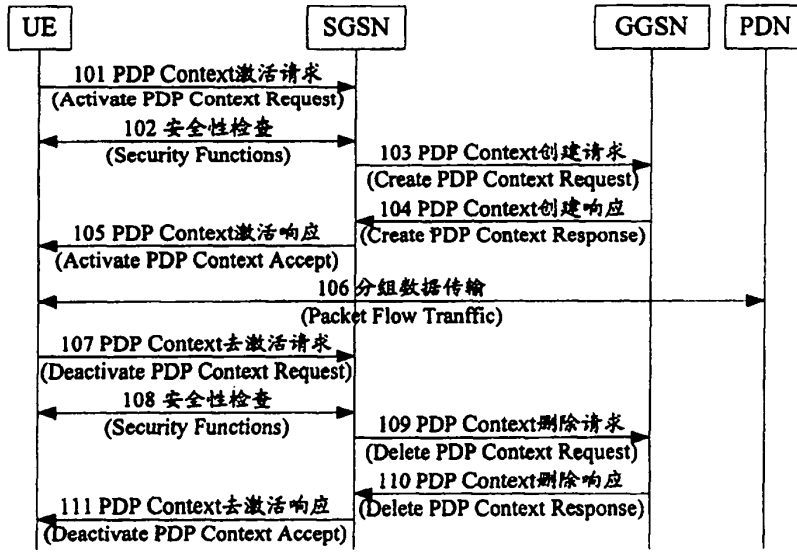

图 2B

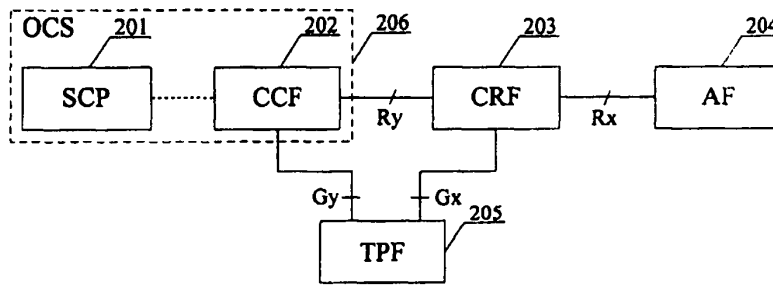

图 3A

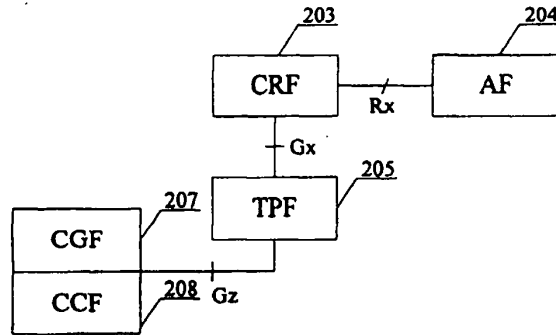

图 3B

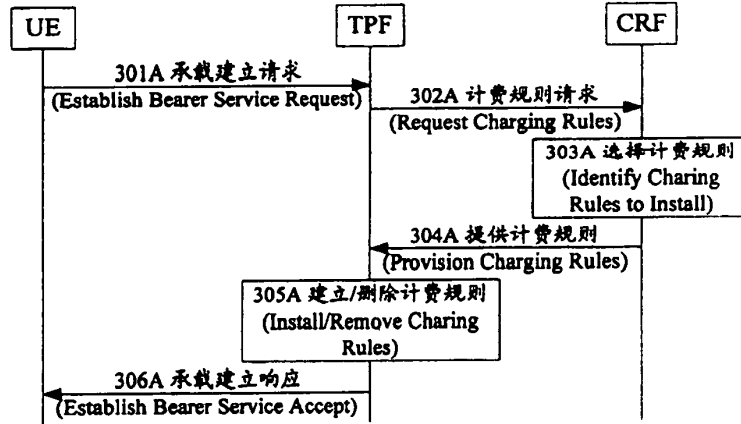

图 3C

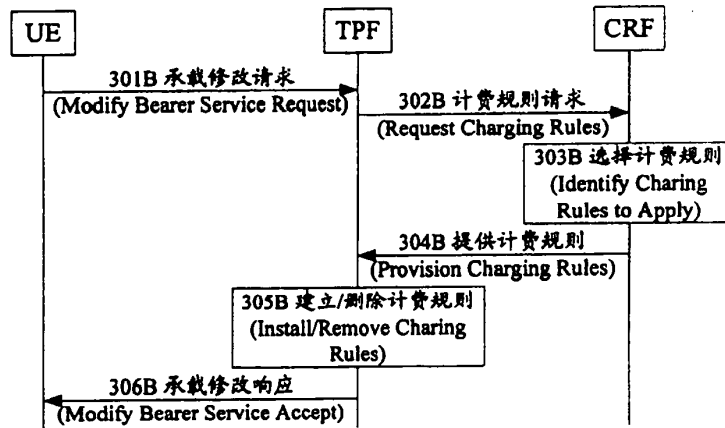

图 4

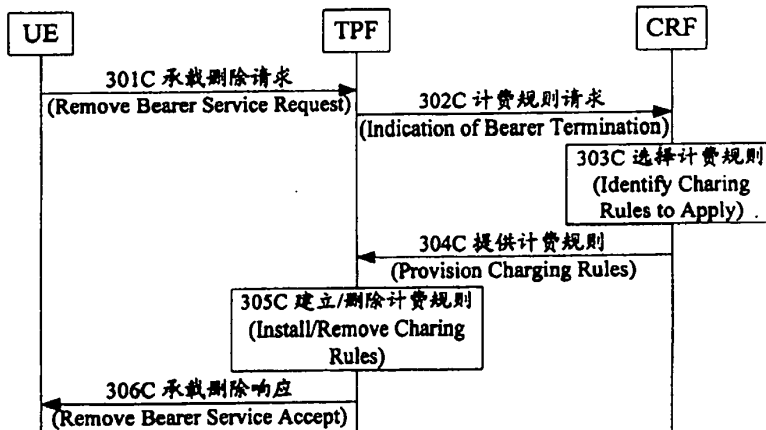

图 5



图 6

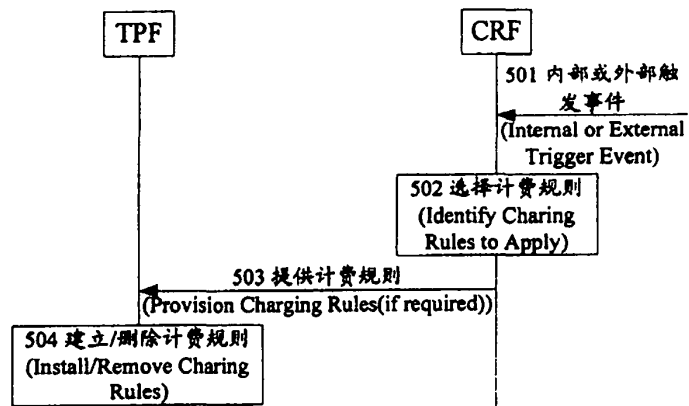

图 7

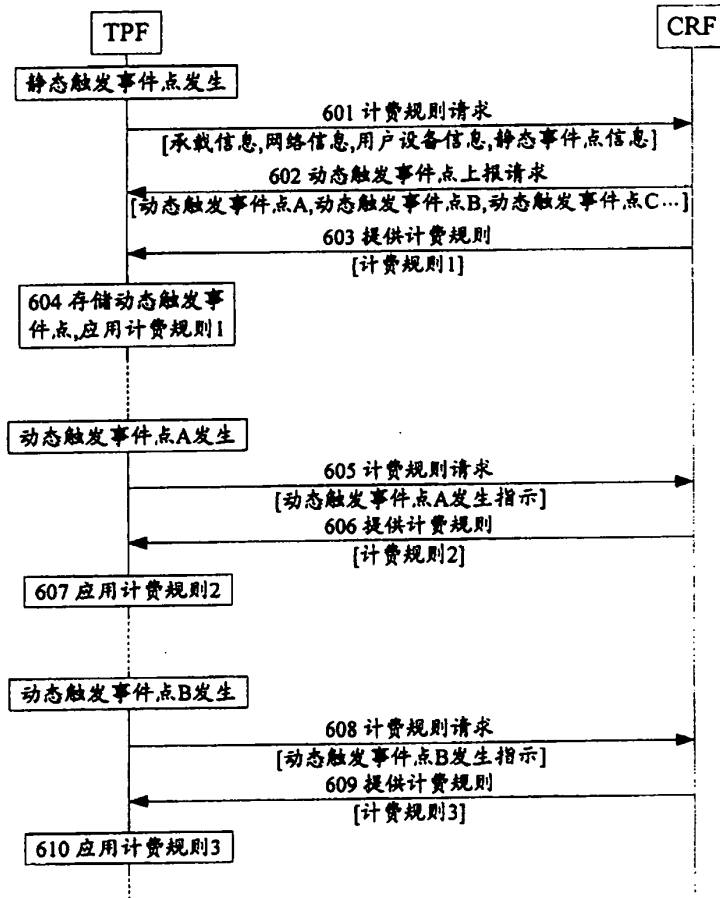

图 8

Real time billing via internet for advanced intelligent network services

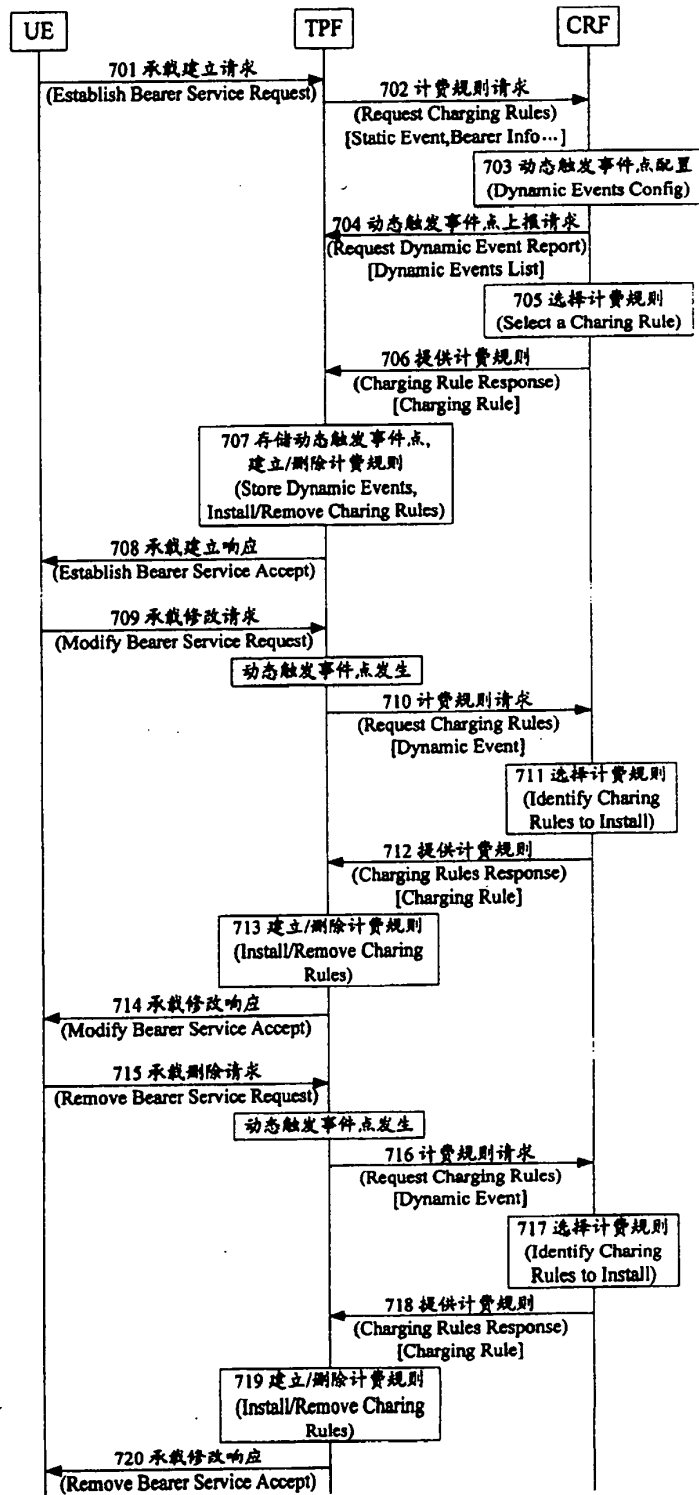
Publication number: CN1222017 (A)

Publication date: 1999-07-07

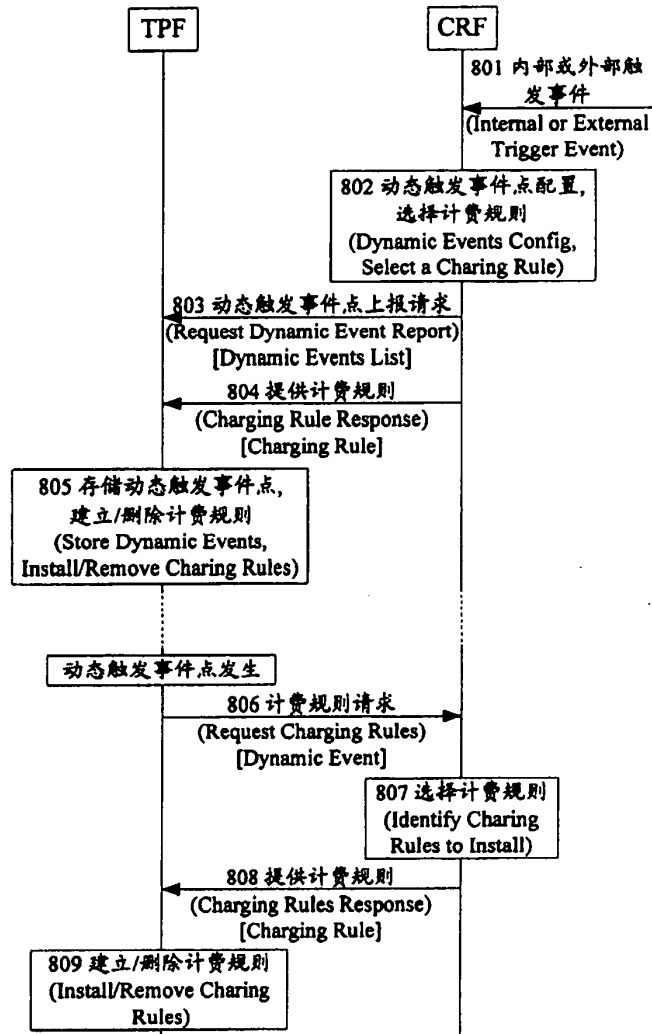
Inventor(s): MANSEY PRADEEP PARSRAM [US]; MANDALIA BAIJU
DHIRAJLAL [US]

Applicant(s): IBM [US]

Classification:

- international: G06F13/00; H04M3/56; H04M15/00; H04M17/00; H04M3/22;
H04M7/00; G06F13/00; H04M3/56; H04M15/00; H04M17/00;
H04M3/22; H04M7/00; (IPC1-7): H04L12/14

- European: H04M3/56; H04M15/00; H04M17/00

Application number: CN19981022673 19981123

Priority number(s): US19970979157 19971126

Also published as:

EP0920178 (C)
EP0920178 (A2)
EP0920178 (A3)
EP0920178 (B1)
US6023499 (A)

more >>

Abstract not available for CN 1222017 (A)

Abstract of corresponding document: EP 0920178 (A2)

The present invention provides for real-time monitoring of charges for using a communication network service, thereby enabling a user to continuously know the charges incurred during each usage. The user also is able to define a charge limit prior to using the service and the usage terminates automatically when the accumulated charge reaches that limit. This approach is particularly suited to monitoring charges associated with a telephone conference call.

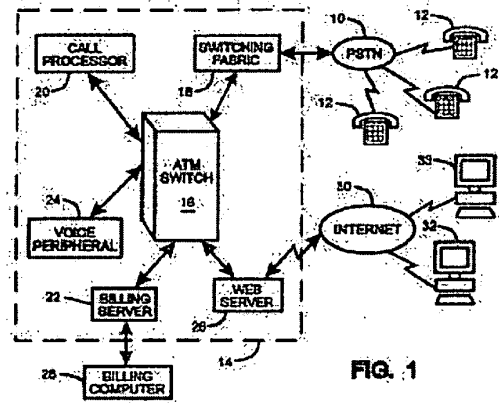

FIG. 1

Data supplied from the *esp@cenet* database — Worldwide

[19]中华人民共和国国家知识产权局

[51]Int. Cl⁶

H04L 12/14

[12] 发明专利申请公开说明书

[21] 申请号 98122673.6

[43]公开日 1999年7月7日

[11]公开号 CN 1222017A

[22]申请日 98.11.23 [21]申请号 98122673.6

[30]优先权

[32]97.11.26 [33]US [31]979157

[71]申请人 国际商业机器公司

地址 美国纽约

[72]发明人 普拉迪堡·帕斯拉姆·曼西

拜久·哈拉勒·曼达列

[74]专利代理机构 中国国际贸易促进委员会专利商标事务所

代理人 于静

权利要求书 3 页 说明书 8 页 附图页数 2 页

[54]发明名称 通过因特网对高级智能网业务进行实时计费

[57]摘要

本方法提供了一种实时监视使用某项通信网业务的技术,它能使用户在每次使用某业务期间都能不断地知道所花的费用。用户也能在使用该业务前,先设定一个费用限额,当累计费用达到此限额时,对该业务的使用就被自动终止。本方法特别适用于监视与电话会议呼叫相关的费用。

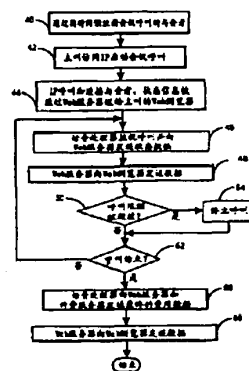

ISSN 1008-4274

专利文献出版社出版

权 利 要 求 书

1. 一种监视某种由高级智能通信网提供的业务的费用的方法, 此方法由以下步骤组成:

检测发生于使用上述业务期间的计费事件的发生;

当一个计费事件发生时, 就给上述业务的累计费用总额中增加一个与该事件相应的费用额;

间或把累计费用总额通过因特网传给正在使用该业务的用户的本地设备上;

在上述业务被使用的同时, 给该用户显示通过因特网接收来的累计费用总额。

2. 权利要求 1 中所描述的方法, 其特点在于它还包括:

存储一个上述业务的费用总额的限额, 此限额由该业务的用户设定; 和

当累计费用总额达到上述限额时, 停止对上述业务的继续使用。

3. 权利要求 1 中所描述的方法, 其特点在于它还包括: 在结束使用上述业务时, 一个高级智能通信网的提供者就会向以下三者之一发出累计费用总额: 一个信用卡帐户, 一个借方帐户或一个由该提供者以外的人操纵的电子商务系统。

4. 权利要求 1 中所描述的方法, 其特点在于检测计费事件发生的步骤包括: 在使用上述业务的期间, 每次都检测一个预先设定好的已过去的时间段。

5. 权利要求 1 中所描述的方法, 其特点在于上述业务是一个会议呼叫业务, 对每一条与某一会议呼叫相连的通信线, 上述添加费用的步骤都包括, 当某一给定的通信线路与上述会议呼叫相连时, 每隔 X 秒给累计费用总额中添加与上述给定的通信线路相应的费用额, 其中 X 是一个正数。

6. 权利要求 1 中所描述的方法, 其特点在于上述业务是一个将数条通信线路互连起来的会议呼叫业务, 当某一给定的通信线路与一个会议呼叫相连时, 上述添加费用的步骤会每隔 X 秒给该通信线路的运行分总额中添

加一个与通信线路相应的费用额，其中 X 是正数；并得出累计费用总额，它是每条通信线路的费用分总额的和的函数。

7. 权利要求 6 中所描述的方法，其特点在于它还包括：

把每条通信线路的分总额都传送到正在使用上述业务的用户的本地设备上；和

在上述业务被使用期间，向该用户显示经因特网接收来的每条通信线路的分总额。

8. 权利要求 1 中所描述的方法，其特点在于上述业务提供了一个涉及多个参与者的会议呼叫，并且还包括：

通过因特网周期地向正在使用上述业务的用户的本地设备发送是否每个与会者都被连到该会议呼叫上的指示；和

在上述业务被使用的同时，向该用户显示每个指示。

9. 一种对涉及到多个通信线路的互连的会议呼叫进行计费的方法，此方法包括以下步骤：

对于每条通信线路，当它与上述会议呼叫相连时，作为对某一预先设定的计费事件的发生的响应，在该会议呼叫的累计费用总额中添加与该计费事件相应的费用额；

间或通过因特网给上述会议呼叫的某个与会者的本地设备传送累计费用总额；和

在上述会议呼叫期间，向上述与会者显示通过因特网接收到的累计费用总额。

10. 权利要求 9 中所描述的方法，其特点在于上述添加费用的步骤包括：在通信线路与会议呼叫相连期间，每隔 X 秒，向通信线路的运行分总额中添加一个费用，其中 X 是一个正数；通过对每条通信线路的分总额求和得出累计费用总额。

11. 权利要求 10 中所描述的方法，其特点在于它还包括：

间或通过因特网给上述会议呼叫的某个与会者的本地设备传送每条通信线路的分总额；和

在上述会议呼叫发生的同时，向上述与会者显示通过因特网接收来的

每条通信线路的分总额。

12. 权利要求 9 中所描述的方法，其特点在于它还包括：

存储某个用户为会议呼叫的总费用所设定的限额；和
当累计费用总额达到上述限额时终止该会议呼叫。

13. 权利要求 9 中所描述的方法，其特点在于它还包括：

通过因特网，定期地向一个正在使用上述业务的用户的本地设备上发送一个指明是否多个通信线路中的每一条都与上述会议呼叫相连的指示；和

在上述业务被使用的同时，向用户显示每条指示。

说 明 书

通过因特网对高级智能网业务进行实时计费

一般地说, 本发明涉及电话系统, 具体地讲, 本发明涉及提供高级智能网(AIN)操作和业务的中心局交换机的电话计费系统。

在过去的几年中, 通过电话网提供的新业务和新特性的数量在不断增加。这些增强的电话网就被称为“高级智能网”(AINs)。支持 AIN 体系结构的电话控制网络包含用于控制交换业务量的智能子系统和用户业务诸如会议呼叫, 呼叫等待, 呼叫转移, 语音广播, 语音应答, 键盘响应等。这些智能子系统被称为“智能外围设备”(IP), 它们被适当配置, 以便能适应特定的区域的呼叫业务。

Deborah L. Acker 和 Thomas E. Creamer 在专利申请号为 08/792,018 的专利申请中公布了作为 AIN 系统的多处理器系统, 它已被转让给国际商用机器公司(IBM)并且它的说明也被结合进本说明书中做为参考。

对于一个会议呼叫, 主叫对智能外围设备发出指令, 让它连接每个会议的参加者。一个电话交换机随后就为每个与会者建立一个单独的支线, 这是通过呼叫每个与会者并将每个支线(leg)的电话线连到一起来实现的。一个给定的支线可能是一个市内的或长途的呼叫。计费是基于每个呼叫的支线的每分钟速率来进行的, 并且此速率通常高于沿同一支线的两用户呼叫的速率。所以不同的速率通常适用于上述会议呼叫的每个支线。很显然, 当大量的用户被用按长途计费的支线连接起来时, 费用累计的速度就相当高了。所以, 在一个会议呼叫的发生过程中, 最好能有一个或多个与会者能在实时的基础上监视该会议呼叫的累计费用。然而与会者在不同的时间加入或离开该呼叫进一步使得会议呼叫费用的实时监视复杂化。

最好能给上述会议呼叫的总费用设一个钱的限额, 这样该呼叫就不会超过某个预算额了。通过用这种方法来限制呼叫的持续时间, 就可迫使与会者遵守该呼叫的议程而不致太冗长繁琐。

依惯例电话或其它类型的网络业务是定期计费的，如按月计费。某一给定的呼叫的帐单直到其所处的计费周期结束时才发出，然后用户有数周的时间来付费。而最好的情况是能在有关某业务的帐单寄出后，尽快收到付款。所以，如能在上述呼叫结束后立即自动地把有关某一特定业务的帐单送给一个由某第三方业务提供者维护的贷方或借方帐户就再好不过了，上述提供者可以是银行信用卡操作等。

本发明的一般目的是要提供对高级智能网业务的实时计费。

本发明的另一个目的是使上述高级网业务的用户能监视服务费用，此费用在该服务被使用期间是累计的。

本发明的另一个目的是使用户能在服务的开始时，为此项特定的使用的费用设定一个钱的限额，并且当达到此限额时能自动终止本使用。

本发明的另一个目的是要在每次使用之后，自动向一个贷方或借方帐户提供增强的网络业务的帐单。

这些和其它目的是通过一种监视一项由高级智能通信网提供的业务的费用的方法来实现的，本方法检测发生在该业务被使用期间的计费事件的发生。当一个计费事件发生时，一个与该事件相应的费用额就被添加到该业务的累计费用总额中。此累计费用总额间或地被通过因特网传送给某个正在使用本业务的用户的本地设备上。例如，不论何时，只要上述累计费用总额有所变化，这种传送就发生。在上述业务被使用的同时，上述本地设备向用户显示通过因特网接收到的累计费用总额。

通过这种方式，在某业务被使用期间，它的运行费用就被不断监视并被显示给用户。这使一个用户在任意一个给定的时刻都能知道当前使用该业务已花了多少钱。

本方法的最佳实施例允许用户为某业务的某次特定的使用设定一个最大开销的限额。当累计费用总额达到此限额时，对该业务的使用就会被自动终止。

例如本方法在电话会议呼叫业务上有特殊的应用。这里为每条与上述会议相连的电话线路保持一个运行费用分总额，甚至当上述每条电话线上都被加上不同的使用速率，上述电话线被在不同的时刻连到会议上或被从

会议上断开时也是如此。每条线路的分总额也被传送并显示给与会者。

图 1 是一个支持 AIN 体系结构的电话网的功能方框图；和

图 2 是一个按照本发明在上述网络上实现的扩展的电话业务进行实时计费的过程的流程图。

首先参见图 1，一个公用电话交换网(PSTN)10 支持高级智能网(AIN)的体系结构。如想得到有关 AIN 结构的更多的信息，请参见如下一种或多种公开文件，它们的说明被并入本说明中做为参考：

Bellcore. GR-2802-CORE, Advanced Intelligent Network (AIN) O.X Issue 1, Generic Requirements, Issue 2, December 1993.(高级智能网络(AIN) O.X 第 1 期，普通需求，第 2 期，1993 年 12 月)。

Bellcore, GR-1129-CORE, Advanced Intelligent Network (AIN) 0.2 Switch Intelligent Peripheral Interface (IPI) Generic Requirments, ILC 1E, November 1994.(高级智能网(AIN) 0.2 交换智能外设接口(IPI)普通需求，ILC 1E，1994。11 月)。

多个电话机 12 连到 PSTN 的市内线路上，可以理解，这些连接中有些可能会涉及到 PSTN 内部的长途连接。

一个智能外设 14 也连到 PSTN10 上，它为经过一个 PSTN 的地区结点(例如连接市内线路和干线的结节)的电话呼叫提供交换连接，并控制与各呼叫相联系的业务应用。这些业务应用包括增强的话音业务，诸如多用户会议，话音广播，语音识别，呼叫等待，和呼叫传递等。

智能外设 14 的硬件可能会基于一个 IBM 的智能外设系统，其成份包括一个“变换结构”组合 18，一个呼叫处理器 20，一个计费服务器 22 和话音外围处理器 24。象话音外围处理器 24 和呼叫处理器 20 这样的关键成份在设置时就有冗余，以便确保系统在任何成份发生损坏时仍能工作。在智能外设 14 的上述多成份之间的话音和数据连接是由一个局域网来提供的，它通常被称为异步传输模式(ATM)交换机 16。

智能外设 14 通过“交换结构”组合 18 来与 PSTN10 相连，此“交换结构”组合是一个常见的电话交换机，它把 PSTN10 的线路互连起来，建立一个两方电话呼叫或需要把大量的 PSTN 线路互连起来的会议呼

叫。呼叫处理器 20 实现了一种呼叫模式，它规定了一个呼叫进入交换结构 18 时的过程。对本发明来讲，交换结构 18 提供构成会议呼叫的 PSTN 线路的物理连接。记费服务器 22 利用了一个用户应用编程接口(APIs)的集合。当对某一特定业务开始记费时，记费服务器 22 接收所提供的业务的标识，该业务涉及的电话号码和呼出线路号。 APIs 序列包括打开记费过程，给记费元素送入适当的记费信息，诸如事务的日期、事务的连接时间、事务的断开连接时间、呼出电话号码、一个或多个终接电话号码、业务类型、记费类型、记费率、累计费用总量。计费服务器 22 在每事务每用户的基础上提供适当的计费数据。计费可设定为按每次使用的时间的长短来计费，也可设定为按使用的次数来计费。一旦 API 关闭了某一给定的业务事务的计费过程，原始的计费数据就被按一种可接受的格式进行整理，并被传送给网络服务提供者的计费计算机系统 28。

智能外设 14 的另一个成份是话音外围处理器 24，它提供以数字方式存储的音频消息或以数方式合成的话音消息，这些消息为呼叫者提供有关的状态信息。例如，这些消息告知呼叫者呼叫的是一个空号，或提醒用户通过电话的键盘输入指令，选择业务功能。

对于本发明，通过给标准智能外设 14 增加一个常用的 Web 服务器 26 作为它与因特网 30 的接口而使 14 得到了增强。这样就能允许连在因特网上的个人计算机 32 和 33 访问智能外设 14，以便建立不同的增强的话音业务。就本发明而言，一个用户可以通过因特网来建立一个会议呼叫，并在该呼叫保持期间在个人计算机 32 上接收实时计费信息。

实现本计费技术的软件存储在智能外设 14 的多成份的内部。最好能在自动会议呼叫的环境下来理解本计费技术，所谓自动会议呼叫即其建立和管理都不需要人工参与。另外，精通本领域的人会理解并赞同：本计费技术可被用于其它形式的增强话音业务，甚至是除电话网以外的其它类型的通信网。

在图 2 中，一个会议呼叫始于步骤 40，它由一个此会议呼叫的主机发起，这里称此主机为“主叫”，主叫访问智能外设 14，以便建立会议呼叫。会议呼叫的预注册可能发生在呼叫的开始，也可能在先于呼叫的某

个时刻，例如，当所有与会者都同意能在某一个给定的时间参加会议时，在这个达成一致意见的时刻就可以进行会议呼叫的预注册。主叫或者可以通过一部电话 12 来访问智能外设 14，进行预注册，或者也可以从个人计算机 32 上通过因特网 30 来进行预注册。在通过电话 12 访问智能外设的情况下，主叫拨电话号码“800”，这是专为此目的而设的。这个电话呼入启动一个过程，在此过程中，话音外围处理器 24 按步骤向主叫发出语音提示，询问有关呼叫建立的时间及每个与会者的电话号码等信息。主叫通过电话机的键盘来输入上述信息。通过因特网和 IP web 服务器 26 对智能外设 14 所进行的类似的访问使得 Web 服务器向主叫的个人计算机 32 发送一系列显示屏幕，主叫在这些屏幕上输入建立一个会议呼叫所必须的信息。其它增强的话音业务的类型可能被用同样的方式来启动，或者通过一部电话，或者通过一个因特网连接。主叫提供给智能外设 14 的信息一直存储在呼叫处理器 20 中，直到到了要建立所预注册的会议呼叫的时间为止。

上述会议呼叫或者被智能外设 14 自动地起始，或者由主叫再次访问智能外设来起始。如果在预先注册期间设定了自动起始，智能外设，具体说是呼叫处理器 20 将会在设定的日期和时间起始上述会议呼叫。在这种情况下，呼叫处理器 20 将通过交换结构 18 呼叫每个与会者，每当电话呼叫被应答时，话音外围处理器 24 就向该与会者发送一个音频消息告诉他这是一个会议呼叫。随后在步骤 44 中，交换结构 18 按照通常的会议呼叫方式将各与会者的 PSTN 线连到一起。

否则，在步骤 42 中，主叫或者可通过一部电话机 12 拨叫适当的“800”电话号码，或者经因特网 30 通过访问 IP web 服务器 26 来访问智能外设。在这种情况下，智能外设会要求主叫输入一个在预注册过程中为该会议呼叫设定的口令。这个口令被转发给话音外围处理器 24，该处理器从存储器中检索预先注册的信息，并用此信息建立会议呼叫。

一个与会者也可经因特网 30 通过一个音频连接来加入到会议呼叫中，这是可以理解的。在这种情况下，与会者通过一台经因特网 30 与 IP web 服务器 26 相连的个人计算机来访问智能外设 14。该与会者选择显示

在 web 服务器的主页上的超级链路以便加入一个会议呼叫, 随后访问 web 服务器 26 的个人计算机 32 会收到一个查询, 要求输入想要加入的会议呼叫的口令。然后, 在处理上述会议的电话呼叫的交换结构 18 和 web 服务器 26 间, 由 ATM 交换机 16 建立起一条话音路径。一个经因特网 30 接入的与会者被用与对待经电话和 PSTN10 接入的与会者相同的方式来对待。这样的一个因特网连接将有一个特殊的每连接时间间隔的计费率(每分钟 0.5 美元)。

为了实时监视会议呼叫的状态, 主叫或任何其他与会者都可通过因特网和 web 服务器 26 访问智能外设 14。当为监视呼叫而在 web 服务器的主页上选择超级链路时, 进行访问的个人计算机 32 或 33 将收到一个查询, 要求输入将要监视的那个会议呼叫的口令。做为对所收到的有效的口令的响应, 智能外设 14 开始给个人计算机 32 或 33 发送该会议呼叫的状态信息, 以便能用 web 浏览器显示。

当构成会议支线的电话线被连接时, 该会议呼叫的每个支线的状态(连接或断开)就被话音外围处理器 24 通过 ATM 交换机 16 发送给 web 服务器 26, 在 26 中, 该呼叫状态被按显示数据的格式进行整理并被通过因特网发送给主叫的计算机 32。这样就使主叫能监视呼叫的状态并能知道每个与会者加入的时间。

当所有已经应答了来自呼叫处理器 20 的呼叫的与会者都被交换结构 18 互连起来的时候, 会议呼叫处理程序就进到步骤 46。可以理解, 当一个或多个答应好要参加会议的与会者没有应答上述起始电话呼叫时, 会议应用会定期地一再发出呼叫, 试图接通上述与会者并把他或她接入会议。在步骤 46 中, 话音处理器 24 监视会议呼叫以便确定是否有与会者离开了会议, 即挂断了电话。

当会议呼叫的每个支线的耗时的增量达到一个计费时间单元的时候(例如每隔 X 秒, 其中 X 是一个正数), 该支线的费用量就增加一个与上述时间单元相对应的长途费用量, 这样就产生了会议呼叫的每个支线的运行分总额。另外, 每个支线的运行分总额之和就产生了整个会议呼叫的累计费用总额。应当明白, 因为每个支线连入的时间稍有不同, 所以计费周期

也不同。

每当有一个会议支线的运行分总额增加时，新的费用总量就会被从话音外设处理器 24 通过 ATM 交换机 16 送到 web 服务器 26。在步骤 48 中，web 服务器 26 把新的费用信息放入一个将被通过因特网 30 传送给主叫的计算机 32 的数据分组中，该新总量将在此计算机上显示。这样就为主叫提供了实时费用数据，这些数据指明了会议呼叫的每个支线的运行分总额和会议呼叫的总费用额。

当一个与会者离开会议时，断开状态就被通过因特网连接发送给主叫。会议的该支线的费用的运行分总额就停止增加，但其最后的值还是要被加到该会议的累计费用总额上去。

在发送完了有关状态及会议呼叫费用的更新数据之后，在步骤 50 中，话音外围处理器 24 判定是否累计总额已超过了在预注册(在步骤 40 中)时为该会议呼叫设定的钱的限额。这一限额功能可以由主叫来实现，也可以不由主叫来实现。直到超过了呼叫限额，实时计费过程才进到步骤 52，决定是否结束该会议呼叫。如果不，则过程返回到步骤 46，这样呼叫处理器就能继续监视会议。

当在步骤 50 中发现上述会议呼叫的累计费用超过了为它预设的限额时，过程就转到步骤 54，在步骤 54 中话音外围处理器 24 指示呼叫处理器 20 结束交换结构 18 中该会议呼叫的所有连接。实际上，可以把话音外围处理器 24 设置成对累计费用接近上述呼叫限额的某个值的时刻进行检测，即累计费用达到一个预设的低于上述呼叫限额的美元数。在那一时刻话音外围处理器 24 通过交换结构 18 向与会者发送一个音频消息，警告他们呼叫的费用已经接近美元限额了。本技术的一项进一步的改进允许主叫在这一时刻通过个人计算机的因特网连接增加美元限额，从而使会议呼叫越过预先设定好的结束点继续进行。

最后，或者当所有与会者都已挂机，或者当在步骤 54 中的终止发生时，在步骤 52 中会议结束被检测到并且计费过程进到步骤 56。此时话音外围处理器 24 向计费服务器 22 发送最终的累计费用以及其它有关该会议连接的正如上面所概括的那些信息。这些数据使计费服务器 22 准备好一

个数据分组并把它发送给网络业务提供者的计费计算机系统 28，这样会议呼叫费用就会出现在主叫的下一个语句中。与此同时，上述累计费用信息被发送给 web 服务器 26，此服务器随后在步骤 58 中通过因特网向计算机 32 上的主叫的 web 浏览器及任何其它连在因特网点的在预注册信息中设定的个人计算机发送上述最终的呼叫信息。随后计费过程结束。

作为上述计费服务器 22 转发有关会议呼叫的信息给网络提供者的计费计算机系统 28 这一过程的替换，智能外设 14 可能通过 web 服务器 26 和因特网 30 向某个信用卡帐户、借方帐户或某个由第三方维护的电子商务系统发送一个事务性消息。这种第三方计费的做法所提供的向网络提供者付费的方式要比那种依靠网络提供者的正常的计费周期和用户付费周期的方式快。

说明书附图

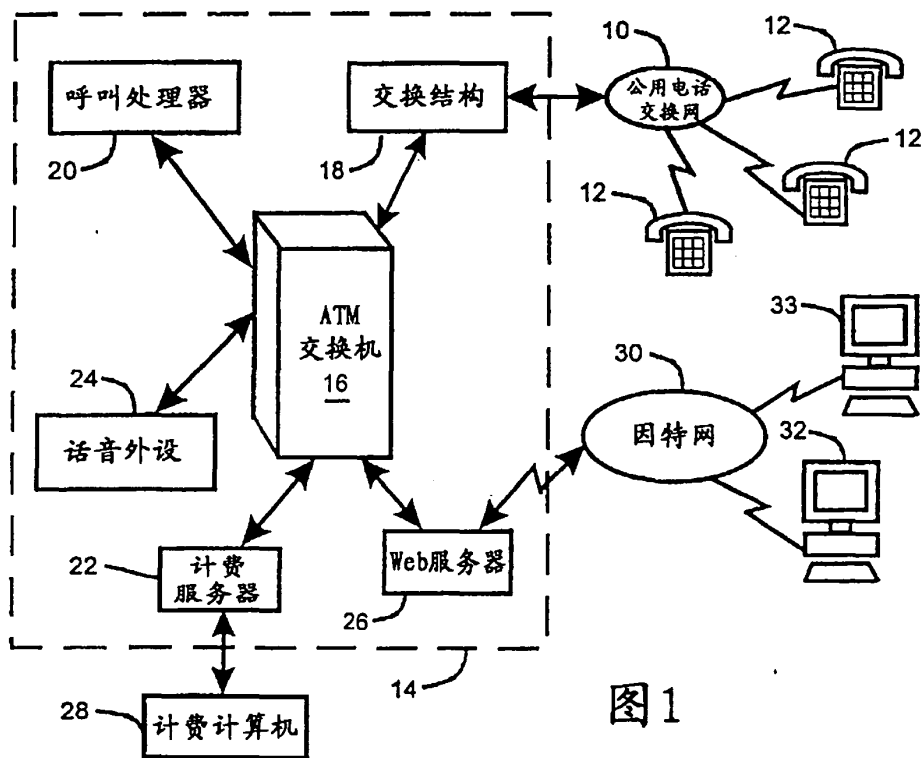



图2

Common charging identifier for communication networks

Publication number: CN1444824 (A)

Publication date: 2003-09-24

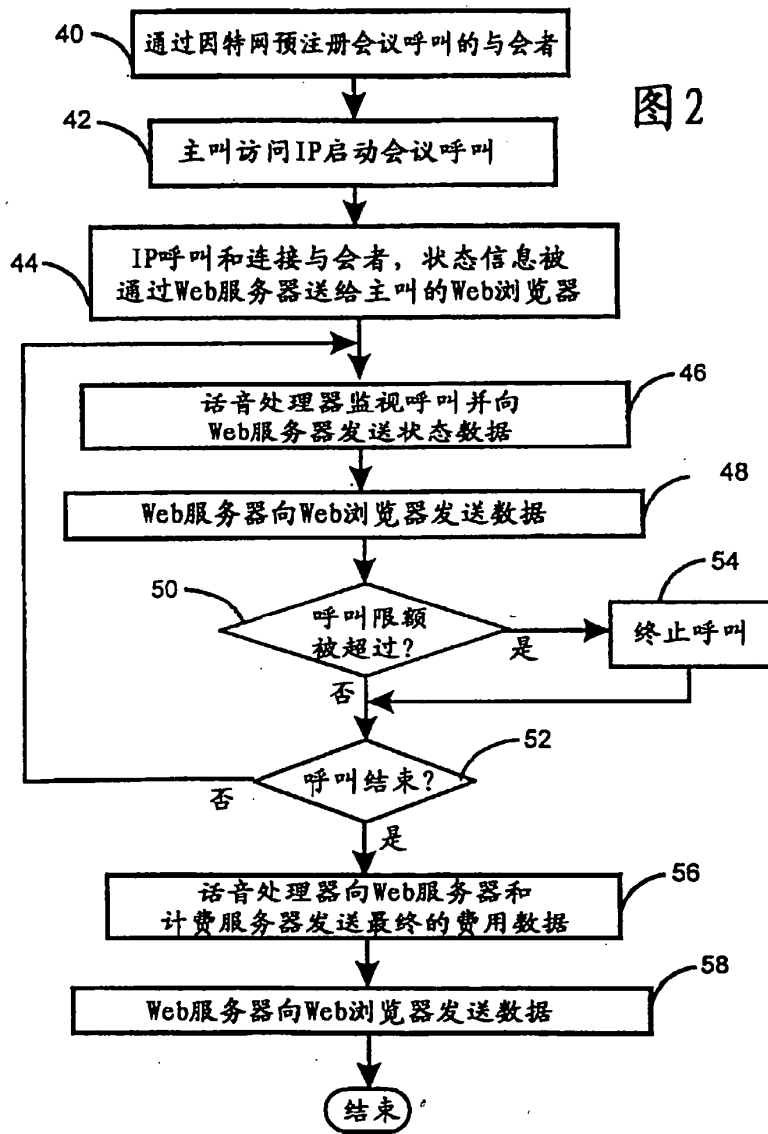
Inventor(s): FACCIN S [FI]; HURTTA T [FI]; BERTENYI B [FI]

Applicant(s): NOKIA CORP [FI]

Classification:

- **international:** **G06Q30/00; H04L12/14; H04L12/56; H04L29/06; H04L29/12; H04M3/00; H04M15/00; H04W8/26; H04W80/04; H04W84/04; G06Q30/00; H04L12/14; H04L12/56; H04L29/06; H04L29/12; H04M3/00; H04M15/00; H04W8/00; H04W80/00; H04W84/02; (IPC1-7): H04M15/00; H04L12/14; H04L29/06**

- **European:** H04L29/06S10C; H04L12/14; H04L12/56B; H04L29/06; H04L29/06M2N2M2; H04L29/06M2N2S2; H04L29/12A6; H04M15/00

Application number: CN20018013343 20010521

Priority number(s): US20000577152 20000524; US20000636738 20000811; US20010758267 20010112

Also published as:

 WO0191446 (A2)

 WO0191446 (A3)

 JP2004507127 (T)

 ES2290131 (T3)

 EP1310085 (A2)

more >>

Abstract not available for CN 1444824 (A)

Abstract of corresponding document: **WO 0191446 (A2)**

In a first embodiment of the invention, when an Activate PDP Context Request message is forwarded to a Service GPRS Support Node (SGSN), the SGSN creates a Create PDP Context Request message and forwards it to a Gateway GPRS Support Node (GGSN). In response to the Create PDP Context Request forwarded by the SGSN, the GGSN creates a Create PDP Context Response message. When a PDP context is created by the GGSN, the GGSN associates a Globally Unique Charging Identification (GCI) with the PDP context. Then, the Create PDP Context Response including the GCI is forwarded to the SGSN. The GCI is sent from the SGSN to the UE and from the UE to the CSCF. In a second embodiment of the invention, the GCI is sent from the SGSN or the GGSN directly to the Call State Control Function (CSCF). Sending the GCI can be performed either autonomously or based on a request from the CSCF.; In either embodiment, the CSCF can send the GCI to a second network which performs processing, such as billing, from data collected from call detail records associated with the GCI.

Data supplied from the *esp@cenet* database — Worldwide

[19] 中华人民共和国国家知识产权局

[51] Int. Cl⁷

H04M 15/00

H04L 12/14 H04L 29/06



[12] 发明专利申请公开说明书

[21] 申请号 01813343.6

[43] 公开日 2003年9月24日

[11] 公开号 CN 1444824A

[22] 申请日 2001.5.21 [21] 申请号 01813343.6

[30] 优先权

[32] 2000. 5. 24 [33] US [31] 09/577,152

[32] 2000. 8. 11 [33] US [31] 09/636,738

[32] 2001. 1. 12 [33] US [31] 09/758,267

[86] 国际申请 PCT/IB01/00890 2001.5.21

[87] 国际公布 WO01/91446 英 2001.11.29

[85] 进入国家阶段日期 2003.1.24

[71] 申请人 诺基亚有限公司

地址 芬兰埃斯波

[72] 发明人 S·法钦 T·胡尔塔 B·伯滕伊

N·伊瓦诺夫 H·洪科

J·-P·科斯基宁 J·瓦利宁

M·霍佩哈朱

[74] 专利代理机构 中国专利代理(香港)有限公司

代理人 栾本生 陈 霁

权利要求书 5 页 说明书 19 页 附图 11 页

[54] 发明名称 用于通信网络的公共计费标识符

[57] 摘要

在本发明的第一实施例中，当一个激活 PDP 上下文请求消息被传递给服务 GPRS 支持节点(SGSN)时，SGSN 会生成一个创建 PDP 上下文请求消息，并且将其传递给网关 GPRS 支持节点(GGSN)。为了响应由 SGSN 传递的创建 PDP 上下文请求，GGSN 会生成一个创建 PDP 上下文响应消息。当由 GGSN 创建 PDP 上下文时，GGSN 会把全球唯一计费标识(GCI)与 PDP 上下文相关联。然后，包括 GCI 的创建 PDP 上下文响应被传递给 SGSN。GCI 被从 SGSN 发送到 UE，并且从 UE 发送到 CSCF。在本发明的第二实施例中，GCI 被直接从 SGSN 或 GGSN 发送到呼叫状态控制功能(CSCF)。可以自动地或者在来自 CSCF 的请求的基础上，来执行发送 GCI 的操作。在上述实施例中，CSCF 能够向根据从与该 GCI 相关的呼叫细节记录收集到的数据进行处理(例如计费)的第二网络发送 GCI。

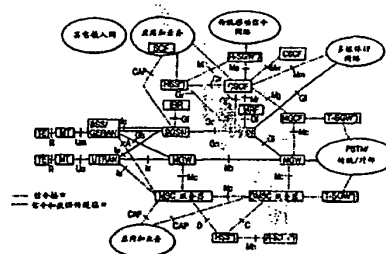

ISSN 1008-4274

知识产权出版社出版

1. 用于协调通信网络内的计费信息的方法，该方法中包括：
建立通信信道；
关联计费标识与该通信信道；以及
- 5 从传输层内的第一网络元素向应用层内的第二网络元素发送该计费标识。
2. 权利要求 1 的方法，其中该第二网络元素把该计费标识添加到该第二网络元素收集的计费信息当中。
3. 权利要求 1 的方法，其中该第一网络元素向该第二网络元素发
- 10 送网络元素的地址以及该计费标识。
4. 权利要求 3 的方法，其中该第二网络元素把网络元素的该地址添加到该第二网络元素收集的计费信息当中。
5. 权利要求 1 或 3 的方法，其中该第一网络元素向该第二网络元素发送安全信息以及该计费标识。
- 15 6. 权利要求 5 的方法，其中该第二网络元素根据该安全信息来校验该计费标识。
7. 权利要求 1 的方法，其中该通信信道是分组数据协议（PDP）上下文。
8. 权利要求 1 的方法，其中该计费标识是 GGSN 分配的计费 ID。
- 20 9. 权利要求 1 的方法，其中该第一网络元素是移动台（MS）。
10. 权利要求 1 的方法，其中该第一网络元素是服务 GPRS 支持节点（SGSN）。
11. 权利要求 1 的方法，其中该第一网络元素是网关 GPRS 支持节点（GGSN）。
- 25 12. 权利要求 1 的方法，其中该第二网络元素是呼叫状态控制功能（CSCF）。
13. 权利要求 9 或 12 的方法，其中 SGSN 向该第一网络元素发送该网络元素的地址。
14. 权利要求 9、10、11 或 12 的方法，其中该网络元素的地址是
- 30 GGSN 的地址。
15. 权利要求 1 的方法，其中该传输层是 GPRS/UMTS。
16. 权利要求 1 的方法，其中该传输层是分组交换核心网络域。

17. 权利要求 1 的方法, 其中该应用层是 IP 多媒体核心网络域。
18. 权利要求 1 的方法, 其中该通信网络是分组交换无线网络。
19. 权利要求 1 的方法, 其中
自动执行发送该计费标识的操作。
- 5 20. 权利要求 1 的方法, 其中
在来自该第二网络元素的请求的基础上, 执行发送该计费标识的操作。
21. 权利要求 1 的方法, 其中该第二网络元素向通信端点发送该计费标识。
- 10 22. 权利要求 21 的方法, 其中该第二网络元素向该通信端点发送安全信息以及该计费标识。
23. 权利要求 21 的方法, 其中该第二网络元素向该通信端点发送网络元素的地址以及该计费标识。
24. 权利要求 9 的方法, 其中该第二网络元素把该第一网络元素的
15 地址添加到该第二网络元素收集的计费信息当中。
25. 用于协调通信网络内传输层和应用层之间的信息的方法, 该方法包括:
启动第一网络元素中该应用层内的事务;
为该事务分配标识;
20 在该第一网络元素内的该传输层中启动通信信道; 以及
利用该标识, 关联该通信信道与该事务。
26. 权利要求 25 的方法, 其中该标识被传递到该应用层内的第二网络元素。
27. 权利要求 26 的方法, 其中该标识被传递到传输层内的第三网
25 络元素和第四网络元素。
28. 权利要求 27 的方法, 其中由该传输层内的该第四网络元素和该第三网络元素以及由该应用层内的第二网络元素所生成的计费信息与该标识相关。
29. 权利要求 25 的方法, 其中该标识是 SIP 消息的呼叫标识。
- 30 30. 权利要求 26 的方法, 其中该第二网络元素是 CSCF。
31. 权利要求 27 的方法, 其中该第三网络元素是 SGSN, 以及该第四网络元素是 GGSN。

32. 权利要求 28 的方法, 其中该计费信息是 CDR。

33. 权利要求 25 的方法, 其中该通信信道是分组数据协议 (PDP) 上下文。

34. 权利要求 25 的方法, 其中该事务是呼叫。

5 35. 用于协调通信网络内的应用层和传输层之间的信息的系统, 系统中包括:

用于启动第一网络元素的该应用层内的事务的装置;

用于为该事务分配标识的装置;

用于启动该第一网络元素的该传输层内的该通信信道的装置; 以

10 及

用于利用该标识, 关联该通信信道与该事务的装置。

36. 用于协调通信网络内的计费信息的方法, 方法中包括:

建立通信连接;

15 在第一网络元素内生成全球唯一的计费标识, 并且关联该全球唯一计费标识与该通信连接; 以及

从该第一网络元素向第二网络元素发送该全球唯一的计费标识。

37. 权利要求 36 的方法, 其中该第二网络元素利用该全球唯一的计费标识来收集计费信息。

20 38. 权利要求 36 的方法, 其中该全球唯一的计费标识当中包括第一网络元素的地址。

39. 权利要求 36 的方法, 其中该通信信道是分组数据协议 (PDP) 上下文。

40. 权利要求 36 的方法, 其中该全球唯一的计费标识由 GGSN 生成。

25 41. 权利要求 36 的方法, 其中该第一网络元素是移动台 (MS)。

42. 权利要求 36 的方法, 其中该第一网络元素是服务 GPRS 支持节点 (SGSN)。

43. 权利要求 36 的方法, 其中该第一网络元素是网关 GPRS 支持节点 (GGSN)。

30 44. 权利要求 36 的方法, 其中该第二网络元素是呼叫状态控制功能 (CSCF)。

45. 权利要求 36 的方法, 其中该第二网络元素向通信端点发送该

全球唯一的计费标识。

46. 权利要求 45 的方法，其中该第二网络元素向第二网络发送该全球唯一的计费标识。

47. 权利要求 45 的方法，其中该第二网络利用该全球唯一的计费标识去收集计费数据，并且利用收集到的计费数据准备记帐。

48. 权利要求 47 的方法，其中该第二网络从与该全球唯一的计费标识相关的多个呼叫细节记录中收集计费数据。

49. 用于协调通信网络内的传输层和应用层之间的信息的方法，该方法中包括：

10 启动第一网络元素的该应用层内的事务；
为该事务内的每个通信连接分配元组或元组对；
启动该第一网络元素的该传输层内的至少一个通信连接；
利用该元组和元组对，关联该至少一个通信连接与该事务。

50. 权利要求 49 的方法，其中该元组或元组对被传递给该应用层
15 内的第二网络元素。

51. 权利要求 50 的方法，其中该元组或元组对被传递给该传输层内的第三网络元素和第四网络元素。

52. 权利要求 51 的方法，其中由该传输层内的该第四网络元素和该第三网络元素以及由该应用层内的第二网络元素所生成的计费信息
20 与该元组或元组对相关。

53. 权利要求 49 的方法，其中该元组中包括事务特定媒介连接的目标 IP 地址以及端口信息。

54. 权利要求 50 的方法，其中该第二网络元素是 CSCF。

55. 权利要求 51 的方法，其中该第三网络元素是 SGSN，而且该第
25 四网络元素是 GGSN。

56. 权利要求 52 的方法，其中该计费信息是 CDR。

57. 权利要求 49 的方法，其中该通信连接是分组数据协议 (PDP) 上下文。

58. 权利要求 49 的方法，其中该事务是呼叫。

59. 用于协调通信网络内的应用层和传输层之间的信息的系统，系
30 统内包含：

用于启动第一网络元素的该应用层内的事务的装置；

-
- 用于为该事务分配元组或元组对的装置；
用于启动该第一网络元素的该传输层内的至少一个通信连接的装置；以及
用于利用该元组或元组对，关联该至少一个通信连接与该事务的
- 5 装置。

用于通信网络的公共计费标识符

技术领域

- 5 本发明涉及到通信网络，而且更加具体而言，本发明涉及到用于对协调和其它类型信息的协调进行计费的技术，以及用于通信网络的公共计费标识符。

背景技术

- 一般而言，分组交换无线网络为移动终端提供没有网络接入所要求的物理层连接的通信。全球移动通信系统（GSM）中的公共分组无线业务（GPRS）以及公共移动地面系统（UMTS）已经被开发研制，去提供具有分组交换侧的无线通信网络，同时还具有电路交换侧。

- 第三代合作组织（www.3gpp.org）已经公布了经过进一步改进的UMTS网络的规范。UMTS规范的00版本可以提供：网络用户可以拥有一个或多个分组数据协议（PDP）地址。每个PDP地址由移动终端（MT）、服务GPRS支持节点（SGSN）以及网关GPRS支持节点（GGSN）内的一个或多个PDP上下文（context）所描述。GGSN是到达外部网络的网关。每个PDP上下文内可以包含用于把数据送入或送出其相关的PDP地址的路由和映射信息，以及用于对所传递的数据进行过滤的业务流模板（TFT）。

- 每个PDP上下文可以有选择地或独立地被激活、修改以及去激活。PDP上下文的激活状态表示针对相应PDP地址和TFT是否能够进行数据的传输。如果与同一PDP地址相关的所有PDP上下文都没有被激活或者去激活，则针对该PDP地址的所有数据传输都被禁止。一个用户的所有PDP上下文都与该用户的国际移动用户标识（IMSI）的同一移动管理（MM）上下文相关联。建立一个PDP上下文意味着建立一个通信信道。

- 图1是说明PDP上下文激活过程实例的过程流程图。在步骤100中，MT向SGSN发送一个激活PDP上下文请求。在步骤100中发送的激活PDP上下文请求消息内包括多个参数。参数内包括PDP地址和接入点名称（APN）。PDP地址被用于去指示：是要求静态PDP还是动态PDP地址。APN是表示所用网关GPRS支持节点（GGSN）的逻辑名称。

在步骤 102, SGSN 向 UMTS 地面无线接入网 (UTRAN) 或 GERAN 或其它相应无线接入网络发送无线接入承载 (RAB) 建立消息。在步骤 104, SGSN 向被影响的 GGSN 发送创建 PDP 上下文请求消息。GGSN 确定是否接受或拒绝该请求。如果请求被接受, 则在步骤 106 中, GGSN 修改其 PDP 上下文表, 并且返回一个创建 PDP 上下文响应消息。然后在步骤 108 中, SGSN 向移动终端发送激活 PDP 上下文接受消息。

在公共移动通信系统规范 (UMTS) 的 00 版本中, 引入一个新的、包含现有和新的逻辑实体的体系结构, 以支持包括 IP 电话在内的 IP 多媒体业务。SIP (会话启动协议) 被用于呼叫的控制。主叫方分配呼叫 ID, 被包含在 SIP 消息当中。呼叫 ID 唯一地识别呼叫, 并且供所有呼叫参与者使用。然而, 在移动台 (MS) 由移动终端 (MT) 和终端设备 (TE) 部分构成的情况下, 呼叫 ID 的使用就会相对复杂, 其原因在于: TE 内的 MT 驱动器最好能够对传递给 MT 的 UDP/IP 分组进行过滤, 而且能够对大多数 UDP 进行分析 (如果不是整个 SIP 语法), 以便去查找包含在 UDP 数据报中的呼叫 ID 域。

语音业务的用户习惯于收到基于呼叫的帐单, 而不是基于实施呼叫所使用的传输资源。IP 电话的用户通常期望类似的计费标准。因此, 针对所用的业务 (例如呼叫) 而不是使用的传输资源进行计费就变得越来越重要。在无线应用协议 (WAP) 业务的情况中, 针对业务而不是传输资源进行计费已经在期望之中。

对于 IP 电话呼叫来说, PDP 上下文被要求去承载真正的语音业务。GPRS/UMTS 层和 IP 电话层都收集计费信息 (CDR): GPRS/UMTS 层收集用于 PDP 上下文的计费信息, 而 IP 电话层收集用于呼叫的计费信息。公共标识符应该被添加到 CDR, 使得能够只在由 IP 电话层 (即针对业务) 所创建的 CDR 的基础上进行计费, 并且省去由 GPRS/UMTS 层 (即针对传输资源) 所创建的 CDR。

在 GPRS/UMTS 层和 IP 电话层所创建的 CDR 中需要公共标识符, 使得能够省去特定 CDR, 并且能够在业务的基础上, 而不是在传输资源的使用的基础上进行计费。更加具体而言, 在多种情况下, 有选择地省去由 GPRS/UMTS 层所创建的 CDR 或由 IP 电话层所创建的 CDR 是有好处的。如上所述情况是可能的, 则计费就可以由运营商指定, 运营商可以确定如何对用户进行计费 (如何利用所创建的 CDR)。

尽管在上述协议中提供了多种细节，但是其中并没有对多种与移动网络相关的特征进行处理。特别是，计费信息可以由 SGSN、GGSN 创建，并且也可以由 IP 电话网络元素（例如 CSCF）创建。目前并没有适当的解决方案，去联系由 SGSN、GGSN 创建的计费信息和由 CSCF 创建的计费信息。的确，网络可以是非常复杂的（例如，可以在多种不同的网络元素中生成计费数据），使得不可能组合所有呼叫事件相关数据。为了实施如下的网络功能，例如热点地区计费或只允许一个网络运营商针对 GPRS 业务和 IP 电话业务实施联合计费，至少某些这种数据是需要的。

10 发明内容

根据本发明的第一说明性实施例，当 MT 向服务 GPRS 支持节点（SGSN）传递激活 PDP 上下文请求消息时，SGSN 会生成一个创建 PDP 上下文请求消息，并且将其传递到网关 GPRS 支持节点（GGSN）。为了响应由 SGSN 传递的创建 PDP 上下文请求，GGSN 会生成一个创建 PDP 上下文响应消息。当 GGSN 创建 PDP 上下文时，GGSN 会把计费标识参数与 PDP 上下文相关联。则包含计费标识参数的创建 PDP 上下文响应就会被传递到 SGSN。为了响应由 GGSN 传递到 SGSN 的 PDP 上下文响应，SGSN 向 MT 传递一个激活 PDP 上下文接受消息。根据本发明的第一实施例，计费标识参数以及可能的 GGSN 地址都通过激活 PDP 上下文接受消息，被提供给 MT。正如在此所描述的，移动台（MS）包括两个部分：终端设备（TE）以及移动终端（MT）。MS 也可以被称作用户设备（UE）。TE 可以例如是连接到 MT 的膝上型电脑。MT 可以是移动电话。

并不必须要发送 GGSN 地址。另一候选方案就是：CSCF 在为呼叫创建的计费记录（CDR）中添加 MS 的 IP 地址。SGSN 和 GGSN 已经在 CDR 中添加了 PDP 上下文的 PDP 地址。通过校验 PDP 地址是否与 IP 地址相同，可以确保 PDP 上下文已经被用于正在处理的呼叫。由于这将要求计费标识是相同的，因此 CSCF 在为正在处理的呼叫创建的 CDR 中添加计费标识。

根据本发明的第二说明性实施例，可以从 SGSN 或 GGSN 向呼叫状态控制功能（CSCF）发送计费标识。当激活 PDP 上下文请求消息被传递给 SGSN 时，SGSN 生成一个创建 PDP 上下文请求消息。SGSN 向 GGSN 发送创建 PDP 上下文请求。为了响应从 SGSN 接收到的创建 PDP 上下文

请求, GGSN 生成一个创建 PDP 上下文响应。GGSN 把计费标识参数与 PDP 上下文相关联。然后, 包括计费标识参数的创建 PDP 上下文响应被传递给 SGSN。

5 可以把计费标识参数直接从 SGSN 或 GGSN 发送到 CSCF; 而且, 这种计费标识参数的发送可以自动执行 (例如在 PDP 上下文激活中), 或者在来自 CSCF 的请求的基础上来执行。

在特定实施例中, CSCF 发送面向通信端点的计费标识, 并且将安全信息、所述计费标识一起发送到所述端点。CSCF 能够向端点发送 GGSN 的地址以及计费标识。如果 GGSN 地址没有与计费标识一起被发
10 送, 则 CSCF 就会在 CDR 中添加移动台 (UE) 的 IP 地址。

在第一和第二说明性实施例的变体中, 计费标识参数就是全球唯一计费标识 (GCI)。(尽管在该申请中被称作“全球”唯一, 但是计费标识只需要被两个运营商使用)。在呼叫期间使用 GCI, 便于合并来自不同网络元素的呼叫事件相关数据。该实施例的一个特定特征就是 CGI 能够由网络元素生成。它可以由 SGSN、GGSN 或 CSCF 生成。
15 这种网络元素可以是二代网络元素或三代网络元素。无论如何, 网络元素 (不是生成 GCI 的网络元素) 不需要生成计费标识, 但是要使用由其它网络元素生成的 GCI。使用 GCI, 可以便于合并所有呼叫事件相关数据或其中的部分数据。例如, GCI 以及呼叫事件的所有计费数据都可以被收集, 并且被其它网络使用, 例如包含为网络用户提供帐单的后处理系统的网络。
20

本发明的原理除了适用于 PDP 上下文之外, 还适用于其它类型的通信信道。

对于 IP 电话呼叫来说, PDP 上下文被要求去承载真正的语音业务。GPRS/UMTS 层和 IP 电话层都可以收集计费信息 (CDR): GPRS/UMTS
25 层收集针对 PDP 上下文的计费信息, 而 IP 电话层收集呼叫的计费信息。根据本发明的第三说明实施例, 在 CDR 中添加公共标识符, 其例如使得能够在由 IP 电话层创建的 CDR 的基础上进行计费 (即针对业务), 并且省去由 GPRS/UMTS 层创建的 CDR (即针对传输资源)。

30 根据本发明的第三实施例的原理, 公共标识符与 GPRS/UMTS 层和 IP 电话层创建的 CDR 相关。公共标识符能够对协调以及其它类型的信息协调进行计费。

SIP 内的呼叫由呼叫标识来识别, 该标识被用作公共标识符。呼叫标识由主叫方分配, 并且被包含在 SIP 消息内。MS 经过 CSCF, 向被叫方发送 SIP 消息。CSCF 截获 SIP 消息, 因此能够从 SIP 消息内获取呼叫标识。

5 根据本发明的原理, 利用呼叫标识对协调或其它类型的信息协调进行计费, MS 在 PDP 上下文激活期间, 会向 SGSN 和 GGSN 发送呼叫标识。更加具体而言, MS 向 SGSN 发送呼叫标识以及激活(辅助) PDP 上下文请求消息, 并且 SGSN 会向 GGSN 传递呼叫标识以及创建 PDP 上下文请求消息。

10 在此所描述的过程可以用于移动台发起的呼叫(其中 MS 分配呼叫标识)以及移动台终止的呼叫(其中 MS 接收到 SIP 邀请消息内的呼叫标识)。根据在此所描述的过程, SGSN 和 GGSN 在针对 PDP 上下文创建的 CDR 内添加呼叫标识, 而且 CSCF 在针对呼叫创建的 CDR 内添加呼叫标识。

15 本发明的第四实施例类似于第三实施例, 除了唯一的标识符是通过利用 SIP “INVITE” 和 “183 会话过程” 的 SDP 句法内出现 UDP 端口号, 而不是利用呼叫 ID 域。

在这些实施例中的一个实施例中, 运营商将具有更大的灵活性, 去确定如何针对所创建的 CDR 对用户进行计费。运营商可以有选择地
20 省去针对由 GPRS/UMTS 层创建的 CDR 的计费, 而是选择对由 IP 电话层创建的 CDR 进行计费。

通过随后的详细描述和附图, 通过实例说明本发明的特征, 可以逐渐明显地看到本发明的其它方面和好处。

附图简述

25 通过随后示范实施例的详细描述以及权利要求, 并且参考附图, 可以更好地理解本发明, 所有这些构成本发明的公开阐述内容。尽管上述和随后书写以及说明的公开阐述集中于本发明的示范实施例, 但是应该清楚地理解到: 上述仅仅是说明和实例, 本发明不仅局限于此。本发明的精神实质和覆盖范围只受限于附加的权利要求。

30 图 1 是说明 PDP 上下文激活过程的公共过程流程图;

图 2 是实现本发明的示范实施例的分组交换无线通信网络的结构公共框图;

图 3 是根据本发明的第一实施例，说明发送计费标识的公共过程流程图；

图 4 是根据本发明的第二实施例的设计，说明发送计费标识的公共过程流程图；

5 图 5 是根据本发明的第二实施例的另一设计，说明发送计费标识的公共过程流程图；

图 6 是根据本发明的第三实施例，说明发送呼叫标识的公共过程流程图；

10 图 7 是根据本发明的第三实施例的设计，说明应用层和传输层之间协调的公共信令流程图；

图 8 是根据本发明的第三实施例的另一设计，说明应用层和传输层之间协调的公共信令流程图；

图 9 是根据本发明的第四实施例，说明发送元组或元组对的公共过程流程图；

15 图 10 是根据本发明的第三实施例的设计，说明应用层和传输层之间协调的公共信令流程图；

图 11 是根据本发明的第四实施例的另一设计，说明应用层和传输层之间协调的公共信令流程图。

执行本发明的最佳模式

20 在开始主题发明的详细描述之前，随后的描述是按顺序安排的，其中在不同的附图中，类似的数字和符号被用于标识相同、相应或类似的元素。而且尽管本发明没有局限于此，但在随后的详细描述中，还是给出实例规模/型号/取值/范围。

支持这些规范的网络结构实例参见图 2 框图中所示的无线通信网络。网络的各种元素及其功能在由第三代合作项目 (www.3gpp.org) 公开发表的公共分组无线业务 (GPRS) 描述 (3GPP TS 23.060, 阶段 2) 中有描述。元素及其功能在 3GPP TS 23.060 规范的或新或旧的版本中都有描述，或者可以是任意其它已知的分组交换无线通信网络。网络元素及其功能的描述仅仅是分组交换无线通信网络的非限制性实例。

30 图 2 中说明的示范网络的若干实例就特别与本发明相关。移动终端 (MT)，通常被称作小区电话或移动电话，只是用户设备 (UE) 中

一个可能的部分。典型地，终端设备 (TE) 与所用的移动终端 (MT) 一起构成用户设备 (UE)，它也被称作移动台 (MS)。任意 UE 可以与本发明共同使用，使其可以操作或经过编程操作在下述的模式中。UMTS 地面无线接入网 (UTRAN) 以及 GPRS 内的基站系统管理并且控制核心网与多个 MT 之间的无线接入。还存在其它可能的类似 GERAN 的无线接入网。

CSCF 是 IP 电话网络内的网络元素。IP 电话网络有时被称作“应用层”。呼叫状态控制功能 (CSCF) 的结构和功能可以被分为若干个逻辑元素，目前他们都处于 CSCF 内部。作为服务 CSCF 的每个 CSCF 都具有呼叫控制功能 (CCF) 功能。CSCF 包括一个 ICGW (输入呼叫网关)。ICGW 作为第一输入点。ICGW 把输入呼叫按路由进行传递。出于最优化的目的，输入呼叫业务触发 (例如呼叫屏蔽/无条件呼叫转移) 可能需要存在。ICGW 执行队列地址处理 (意味着与其它实体管理相关)；并且与归属用户服务器 (HSS) 进行通信。

CCF (呼叫控制功能) 执行呼叫建立/终止以及状态/事件管理；与 MRF 进行交互，使得可以支持多方和其它业务；报告呼叫事件，用于计费、审核、截获或其它目的；接收并且处理应用层的注册；执行队列地址处理 (意味着管理相关性)；并且可以提供针对应用和业务网络 (VHE/OSA) 的业务触发机制 (业务能力特征)。CCF 可以调用与服务网络相关的基于定位的业务，并且可以校验给定当前的预约，所请求的输出通信是否被允许。

CSCF 中包括 SPD (业务分布数据库)。SPD 与归属域内的 HSS 进行交互，为 R00 全 IP 网络用户接收分布信息，并且根据归属域的 SLA 将其进行存储。SPD 把初始用户接入 (其中包括例如 CSCF 信令传输地址、用户 ID 等等) 通知归属域。SPD 可以缓冲存储接入相关信息 (例如用户到达的终端 IP 地址等)。

CSCF 执行 AH (地址处理) 功能。AH 功能中包括分析、翻译、修改地址的可移植性 (如果有要求的话) 以及别名地址的映射。AH 功能可以为网络间的路由进行暂时地址处理。

服务 GPRS 支持节点 (SGSN) 是为 MT 提供业务的节点。在 PDP 上下文激活时，SGSN 建立用于路由目的的 PDP 上下文。由于对 PDP 地址评估，因此网关 GPRS 支持节点 (GGSN) 就是外部分组数据网络的接入

节点。其中包含针对附加 GPRS/UMTS 用户的路由信息。路由信息被用于把协议数据单元 (PDU) 隧道传递给 SGSN。SGSN 和 GGSN 的功能可以驻留在不同的物理节点中, 或者可以被组合在同一物理节点中, 例如互联网 GPRS 支持节点 (IGSN)。

- 5 基于 IP 的移动网络结构中包含应用层和传输层。传输层协议和机制通常被最优化, 用于特定类型的接入, 而应用层则一般是公共的, 独立于接入类型。

在基于 IP 的移动网络内, UE 通过向对等实体发送信令来建立呼叫并且通过由传输层所提供的 IP 连接来交换呼叫控制协议的消息。在应用层内建立呼叫的过程中, 底层的传输层必须要在无线接口之上以及传输网络内建立传输承载。对于基于 IP 的移动网络, 传输承载的建立就意味着分配无线资源和网络资源。呼叫控制信令通过由传输层所提供的 IP 连接进行透明地交换。

实施例 1

- 15 图 3 根据本发明的第一实施例, 说明发送计费标识的过程。在 UMTS 全 IP 网络内, 当 GPRS/UMTS 被称作针对多媒体和基于 IP 业务的语音的访问/传输网络时, 在 GPRS/UMTS 层和应用层 (例如 CSCF) 独立地执行计费。

在 GPRS 和 UMTS 网络内, GGSN 根据来自 SGSN 的请求 (利用创建 PDP 上下文请求消息) 创建 PDP 上下文, SGSN 进而从 MT 接收请求 (激活 PDP 上下文请求消息)。

如图 3 所示, 本发明的技术在应用层, 从步骤 300 开始, 其中触发被从 TE (终端设备) 传递给 MT (移动终端)。触发可以例如是包括请求逻辑信息和特征的呼叫建立指示, 它被从 TE 发送给 MT, 启动 PDP 上下文激活。

在步骤 302, 激活 PDP 上下文请求消息被传递给 SGSN。为了对其进行响应, 在步骤 304 内, SGSN 生成创建 PDP 上下文请求消息, 并且将其传递给 GGSN。为了响应由 SGSN 传递的创建 PDP 上下文请求, 在步骤 306 内, GGSN 生成创建 PDP 上下文响应消息。

30 在步骤 308 内, 当 PDP 上下文由 GGSN 创建时, GGSN 把计费标识参数与 PDP 上下文相关联。然后在步骤 310 内, 把包含计费标识参数的创建 PDP 上下文响应消息传递给 SGSN。

进而，为了响应由 GGSN 传递给 SGSN 的 PDP 上下文响应，在步骤 312 中，SGSN 向 MT 发送激活 PDP 上下文接受消息。根据本发明的第一实施例，计费标识参数和 GGSN 地址都在激活 PDP 上下文接受消息内被提供给 MT。

5 根据需要的 PDP 上下文，将步骤 300-312 内的上述过程重复所需要的多次。

当步骤 312 内的最后过程的完成之后，在步骤 314 内，UE 把包括请求逻辑信道和特征的呼叫建立消息传递给 CSCF（呼叫状态控制功能）。MT 进而在呼叫建立消息内向 CSCF 提供计费标识和 GGSN 地址。
10 在步骤 316 内，CSCF 进而把包括请求逻辑信道和特征的呼叫建立消息传递给远端端点。然后在步骤 318 内，远端端点把包括接受的逻辑信道和特征的响应消息传回 CSCF。然后在步骤 320 内，CSCF 把包括接受逻辑信道和特征的响应消息传递给 UE。响应消息可以例如是 H. 323 内的连接消息或 SIP 响应消息，但是并不必局限于此。

15 本发明考虑：通过采用适当的加密算法，可以避免恶意 MT 向 CSCF 传递虚假计费标识，来代替合法的数值，或者恶意 MT 重新使用计费标识的取值，因此计费标识参数会更加安全。

根据上述，可以理解到：在本发明的第一实施例中，计费标识参数被从 SGSN 发送到 UE，并且从 UE 发送到 CSCF。

20 实施例 2

图 4 根据本发明的第二实施例的设计，说明了发送计费标识的过程。在 UMTS 全 IP 网络中，当 UMTS/GPRS 被称作针对多媒体和基于 IP 业务的语音的接入/传输网络时，在 GPRS/UMTS 层和应用层（例如 CSCF）独立地进行计费。

25 在 GPRS 和 UMTS 网络中，GGSN 根据来自 SGSN 的请求（即创建 PDP 上下文请求消息）去创建 PDP 上下文，SGSN 进而又从 MT 中接收请求（即激活 PDP 上下文请求）。根据本发明的第二实施例，从 SGSN 或 GGSN 向 CSCF 发送计费标识参数。与第一实施例不同的是，不需要通过 UE 发送计费标识参数。

30 如上所述，在本发明的第一实施例中，MT 截获由 TE 发出的数据分组，并且把计费标识参数添加到特定数据分组当中（SIP 消息或用于呼叫建立的 H. 323 消息）。数据分组的截获可以降低 MT 的性能。

在本发明的第二实施例中，例如为了合并由 SGSN 和 GGSN 收集的针对 PDP 上下文以及由 CSCF 针对呼叫收集的计费信息，GPRS/UMTS 和 IPT 网络元素能够协调计费信息或其它类型的信息。类似于第一实施例，GGSN 在 PDP 上下文激活期间分配计费 ID 参数。而且类似于第一实施例，GGSN 向 SGSN 发送计费 ID 参数。但是，第二实施例的独特之处在于：计费标识以及其它可能的信息（例如 IMSI、MSISDN、PDP 地址、来自 TFT 的 UE 端口号、计费特征等等）可以被从 SGSN 或 GGSN 发送给 CSCF。

可以自动地执行或者在来自 CSCF 的请求的基础上，去发送计费 ID 参数。由于如果需要发送某些信息，则 CSCF 必须是已知的，因此 SGSN 要发送计费标识。SGSN 具有与 HSS (HLR + UMS) 的接口，其中包含服务 CSCF 的地址。

在 GGSN 和 CSCF 之间还可能存在接口。这一新接口可以被用于承载计费 ID 以及其它可能的计费相关信息。图 4 中说明了本发明的第二实施例的一个方面，其中 SGSN 向 CSCF 发送计费 ID。

如图 3 所示，本发明发送计费标识的过程从步骤 400 开始，其中从 TE (终端设备) 向 MT (移动终端) 发送触发。触发可以是例如包括请求的逻辑信道和特征的呼叫建立消息。

在步骤 402，激活 PDP 上下文请求消息被传递给 SGSN。为了对此进行响应，在步骤 404，SGSN 生成一个创建 PDP 上下文请求消息。

在步骤 406，SGSN 向 GGSN 发送创建 PDP 上下文请求。在步骤 408，响应从 GGSN 接收到的创建 PDP 上下文请求，GGSN 生成一个创建 PDP 上下文响应。在步骤 410，GGSN 把计费标识参数与 PDP 上下文关联起来。在步骤 412，创建 PDP 上下文响应和计费标识在创建 PDP 上下文响应消息内，被返回给 SGSN。

计费 ID 被包含在由 GGSN 和 SGSN 创建的 CDR 中。该 CDR 被发送到计费网关功能 (CGF)，用于进一步处理。把 CDR 从计费网络功能发送到计费系统。对于所有实施例来说都是这样。此外，CSCF 在为正在处理的呼叫而创建的 CDR 中添加计费 ID，这一点也是非常重要的。CSCF 向计费网关功能 (CGF) 或计费系统发送 CDR。这样，当为用户生成计费帐单时，能够校验用于特定呼叫的 PDP 上下文。在这些 CDR 中的计费标识都是相同的。

如果在激活 PDP 上下文期间计费特征发生变化,则 SGSN 在更新的 PDP 上下文请求消息中包括 PDP 上下文的新计费特征,SGSN 向 GGSN 发送该消息。

5 根据第二实施例的这种设计,在步骤 414 中,计费 ID 参数以及其它可能的信息(例如 IMSI、MSISDN、PDP 地址、来自 TFT 的 UE 端口号、计费特征等等)被直接从 SGSN 发送到 CSCF。这可以自动执行(第一情况),或者在来自 CSCF 的请求的基础上执行(第二情况)。

在第一情况中,PDP 上下文激活(和修改)时,SGSN 向 CSCF 发送包括计费 ID 和其它可能信息(如上所述)的消息。CSCF 可以对 SGSN
10 发出的消息进行确认。

SGSN 必须得知 CSCF 地址。CSCF 地址可以从 HSS 请求得到,或者从 UE 为与 CSCF 通信所用的 PDP 上下文而指定的 TFT 中得到。

在第二情况中,呼叫建立时,CSCF 从 SGSN 请求信息。该请求可以基于 IMSI 或 MSISDN。SGSN 向 CSCF 发送计费 ID 和其它可能的信息
15 (如上所述)。

CSCF 必须得知 SGSN 地址。SGSN 地址可以从 HSS 中请求得到。

在步骤 416 中,CSCF 进而把呼叫建立消息传递给远端端点。然后在步骤 418 中,远端端点把响应消息传递回 CSCF。然后在步骤 420 中,CSCF 把响应消息传递给 UE。

20 图 5 中说明了本发明第二实施例的另一设计,其中 GGSN 直接把计费标识发送给 CSCF。参考图 5,本发明发送计费标识的过程从步骤 500 开始,其中触发被从 TE 发送给 MT(移动终端)。触发可以例如是包括请求逻辑信道和特征的呼叫建立消息。

在步骤 502,激活 PDP 上下文请求消息被传递给 SGSN。在步骤 504
25 为了对此响应,SGSN 生成一个创建 PDP 上下文请求消息。在步骤 506,SGSN 向 GGSN 发送创建 PDP 上下文请求。

为了响应从 SGSN 接收到的创建 PDP 上下文请求,在步骤 508,GGSN 生成一个创建 PDP 上下文响应。在步骤 510,GGSN 把计费标识参数与 PDP 上下文相关联。然后在步骤 512,包括计费标识的创建 PDP 上下文
30 响应消息被返回 SGSN。

根据第二实施例的这一方面,在步骤 514 中,计费 ID 参数以及其它可能的信息(例如 IMSI、MSISDN、PDP 地址、来自 TFT 的 UE 端口号、

计费特征等等)被直接从 GGSN 发送到 CSCF。步骤 514 可以自动执行(第一情况),或者在来自 CSCF 的请求的基础上执行(第二情况)。

在第一情况中, PDP 上下文激活(和修改)时, SGSN 向 CSCF 发送包括计费 ID 和其它可能信息(如上所述)的消息。CSCF 可以对 GGSN 发出的消息进行确认。

GGSN 必须得知 CSCF 地址。CSCF 地址可以从 HSS 请求得到,或者从 UE 为与 CSCF 通信所用的 PDP 上下文而指定的 TFT 中得到。

在第二情况中, 呼叫建立时, CSCF 从 GGSN 请求信息。该请求可以基于例如 IMSI 或 MSISDN。GGSN 向 CSCF 发送计费 ID 参数以及其它可能的信息。

在步骤 516 中, CSCF 向远端端点发送呼叫建立消息。在步骤 518 中, 远端端点把响应消息传递回 CSCF。在步骤 520, CSCF 向 UE 发送响应消息。

例如为了合并由 SGSN 和 GGSN 收集的针对 PDP 上下文以及由 CSCF 针对呼叫收集的计费信息, 第二实施例允许 GPRS 和 IPT 网络元素能够协调计费信息或其它类型的信息。从 GGSN 或 SGSN 向 CSCF 发送计费标识需要应用层与传输层之间的接口。

实施例 1 和 2 的变体

在第一和第二实施例的变体中, 由 SGSN、GGSN 或其它网络元素所生成的计费标识是全球唯一的计费标识(GCI)。GCI 是整数值 $2^{32} - 1$ (四个字节)与生成该数值的网络元素(例如 SGSN 或 GGSN) ID 的组合。生成 GCI 的网络元素 ID 的长度或结构可以根据特定实施例方案进行变化。GCI 不必在任意的特定网络元素组内生成。在任何情况下, 其余网络元素可以简单地接收并且使用由第一网络元素所生成的 GCI。

生成 GCI 之后, 供整个呼叫期间使用, 并且其它网络元素不会生成计费标识, 而是使用由第一网络元素生成的 GCI。GCI 被创建, 并且通过多个接口进行传递, 来代替上述的计费标识。能够生成多个单独呼叫的细节记录(CDR), 并且利用 GCI 相互关联。例如, 如 3G TS 32.015 中的解释, SGSN 可以创建 S-CDR, GGSN 可以创建 G-CDR。CSCF (与 MGCF 一起) 可以创建 C-CDR。终止网络(例如 PSTN/MSC) 可以创建 POC 以及 MTC CDR。

当端点（例如 MGCF）接收由 CSCF 传递的 GCI，它可以将其传递到另一网络。GCI 最好在上述的二代（2G）以及 3G 网络中传递。SIP 和 GTP 协议可以被用于在上述 3G 网络内承载 GCI，而且 2G 网络内的相应协议要被修改，使得它们也可以承载 CGI。作为实例，所连接的 2G 网络可以是后处理系统，它通过有效地利用 GCI，为一个或多个 CDR 内的用户确定并且合并计费数据，生成用户帐单。

实施例 3

语音业务的用户习惯于收到基于呼叫的帐单，而不是基于实施呼叫所使用的传输资源的帐单。IP 电话的用户通常期望相同的计费标准。因此，针对所用的业务（例如呼叫），而不是使用的传输资源进行计费就变得越来越重要。在 WAP 业务的情况中，针对业务，而不是传输资源计费已经在期望之中。

对于 IP 电话呼叫来说，PDP 上下文被要求去承载真正的语音业务。GPRS/UMTS 层和 IP 电话层都收集计费信息（CDR）：GPRS/UMTS 层收集用于 PDP 上下文的计费信息，而 IP 电话层收集用于呼叫的计费信息。公共标识符应该被添加到 CDR，使得能够只在由 IP 电话层（即针对业务）所创建的 CDR 的基础上进行计费，并且省去由 GPRS/UMTS 层（即针对传输资源）所创建的 CDR。

在 GPRS/UMTS 层和 IP 电话层所创建的 CDR 中需要公共标识符，使得能够省去特定 CDR，并且能够在业务的基础上，而不是在传输资源的基础上进行计费。更加具体而言，在多种情况下，有选择地省去由 GPRS/UMTS 层所创建的 CDR 或由 IP 电话层所创建的 CDR 是有好处的。如果上述情况是可能的，则计费就可以由运营商指定，因为运营商可以确定如何对用户进行计费（如何利用所创建的 CDR）。

根据本发明的原理，公共标识符与由 GPRS/UMTS 层和 IP 电话层所创建的 CDR 相关。公共标识符能够进行计费协调以及其它类型的信息协调。

SIP 内的呼叫由被称作计费协调符号的呼叫标识来识别，而不是使用 GGSN 分配的计费标识。呼叫标识由主叫方分配，并且被包含在 SIP 消息内。MS 经过 CSCF 向被叫方发送 SIP 消息。CSCF 截获 SIP 消息，并且从 SIP 消息内获得呼叫标识。

为了根据本发明的原理，使用用于计费协调或其它类型协调的呼

叫标识, MS 在 PDP 上下文激活期间, 向 SGSN 和 GGSN 发送呼叫标识。更加具体而言, MS 向 SGSN 发送呼叫标识以及激活(辅助) PDP 上下文请求消息, 而且 SGSN 把呼叫标识以及创建 PDP 上下文请求消息发送到 GGSN。

5 图 6 根据本发明的第三实施例, 说明用于协调计费的过程, 其中有益地改善传输和应用层之间信息的协调。如图 6 所示, 本发明的技术在应用层, 从步骤 600 开始, 其中触发可以被从 TE (终端设备) 发送到 MT (移动终端)。触发可以例如是包括请求逻辑信道和特征的呼叫建立消息, 它被从 TE 发送到 MT, 去启动 PDP 上下文激活。在步骤 10 602, MS 以呼叫的形式启动事务。在步骤 604, MS 为呼叫分配呼叫标识。在此所描述的过程可以用于如随后图 7 中描述的移动台发起的呼叫(其中 MS 分配呼叫标识), 并且还适用于随后图 8 中描述的移动台终止的呼叫(其中 MS 在 SIP 邀请消息内接收呼叫标识)。在步骤 606, 从 MS 向 CSCF 发送呼叫标识。

15 在步骤 608, 激活(辅助) PDP 上下文请求消息以及呼叫标识被从 MS 传递给 SGSN。在步骤 610, SGSN 向 UTRAN 发送无线接入承载(RAB)建立消息。为了对其响应, 在步骤 612 中, SGSN 生成一个创建 PDP 上下文请求消息, 并且将其与呼叫标识传递给 GGSN。在步骤 614, 为了响应由 SGSN 传递的创建 PDP 上下文请求, GGSN 生成创建 PDP 上下文 20 响应消息。

在步骤 616, 创建 PDP 上下文响应消息被传递给 SGSN。在步骤 618, 为了响应由 GGSN 传递给 SGSN 的 PDP 上下文响应, SGSN 向 MS 传递激活(辅助) PDP 上下文接受消息。

25 根据在此描述的过程, SGSN 与 GGSN 在其针对 PDP 上下文创建的 CDR 中添加呼叫标识, 并且 CSCF 在其针对呼叫创建的 CDR 中添加呼叫标识。

因此, 运营商将具有更大的灵活性, 去确定如何针对所创建的 CDR 对用户进行计费。运营商可以有选择地省去针对由 GPRS/UMTS 层创建的 CDR 的计费, 而是选择对由 IP 电话层创建的 CDR 进行计费。

30 图 7 是说明根据本发明的第三实施例的设计, 说明应用层和传输层之间协调的信令流程图。为了能够针对移动台发起的呼叫, 对协调或其它类型的信息协调进行计费, 在呼叫建立时向 CSCF 发送呼叫 ID, 而

且在 PDP 上下文激活时向 SGSN 和 GGSN 发送呼叫 ID。参考图 7，在步骤 700，MS 分配呼叫 ID，并且在 SIP 邀请消息中将其发送到 CSCF。在步骤 702，MS 至少为呼叫激活一个 PDP 上下文。MS 在激活（辅助）PDP 上下文请求消息中，向 SGSN 发送发送呼叫 ID。如果为呼叫激活多个 PDP 上下文，则 MS 必须在每次 PDP 上下文激活时，都要向 SGSN 发送呼叫 ID。在步骤 704，执行无线接入承载的建立。在步骤 706，SGSN 在创建 PDP 上下文请求消息中，向 GGSN 发送呼叫 ID。在步骤 708 和 710 中，（辅助）PDP 上下文激活被接受。

图 8 根据本发明第三实施例的另一设计，说明应用层和传输层之间协调的信令流程图。图 8 中给出针对移动台终止呼叫的计费协调的实例。参考图 8，在步骤 800，MS 接收 SIP 邀请消息。主叫方已经为呼叫分配呼叫 ID。在步骤 802，MS 为呼叫至少激活一个 PDP 上下文。MS 在激活（辅助）PDP 上下文请求消息中，向 SGSN 发送呼叫 ID。如果为呼叫激活多个 PDP 上下文，MS 必须在每次 PDP 上下文激活时，都向 SGSN 发送呼叫 ID。在步骤 804，执行无线接入承载的建立。在步骤 806，SGSN 在创建 PDP 上下文请求消息中，向 GGSN 发送呼叫 ID。在步骤 808 和 810，（辅助）PDP 上下文激活被接受。

实施例 4

在类似于上述实施例 3 的另一实施例中，与由 GPRS/UMTS 层和 IP 电话层所创建的 CDR 相关的公共标识符是用于区分 IP 网络内连接的元组或元组对。“元组”由 IP 地址以及与连接的 RTP 数据流相关的 UDP 端口号组成。“元组对”由源端和目的端连接端点的元组构成。为了根据本发明的原理，利用元组或元组对对协调或其它类型的协调进行计费，MS 在 PDP 上下文激活时，将其发送给 SGSN 和 GGSN。更加具体而言，MS 将它们以及激活（辅助）PDP 上下文请求消息发送给 SGSN，而且 SGSN 将它们以及创建 PDP 上下文请求消息一起发送给 GGSN。

图 9 根据本发明的第四实施例，说明用于对计费进行协调的过程。在步骤 900 中，触发被从 TE（终端设备）发送给 MT（移动终端）。触发可以例如是包含请求的逻辑信道和特征的呼叫建立指示，它被从 TE 发送到 MT，以启动 PDP 上下文激活。在步骤 902 中，MS 以呼叫的形式启动事务。在步骤 904，MS 为其建议在呼叫中使用的每个所提出的媒体流分配元组。该信息可以被承载在 SIP INVITE 内的 SDP 部分中，并

且如果远端端点同意使用所提出的媒介，则它可以被用作远端端点的目的元组。在此所描述的过程可以用于如随后图 9 中描述的移动台发起的呼叫（其中 MS 分配 UDP/IP 元组值），并且还适用于随后图 9 中描述的移动台终止的呼叫（其中 MS 接收 SIP INVITE 消息内的元组）。

5 在步骤 906，从 MS 向 CSCF 发送元组。

在步骤 908 中，媒介协商经过 CSCF 信令链，穿过必需的往返路径，并且终止 MS 针对每个媒介流都至少得知初始同意的目的和源连接元组（元组对）。起始和终止终端的 P-CSCF 从经过的 SIP 消息中分析并且获取元组对取值（从媒介认证和策略控制目的）。激活（辅助）PDP
10 上下文请求消息以及连接特定的元组对信息被从 MS 传递给 SGSN。在步骤 910，SGSN 向 UTRAN 发送无线接入承载（RAB）建立消息。对其响应，在步骤 912 中，SGSN 生成一个创建 PDP 上下文请求消息，并且将其和元组对一起传递给 GGSN。在步骤 914，为了响应由 SGSN 传递的创建 PDP 上下文请求，GGSN 生成一个创建 PDP 上下文响应消息。

15 在步骤 916，创建 PDP 上下文响应消息被传递给 SGSN。在步骤 918 中，为了响应从 GGSN 传递给 SGSN 的 PDP 上下文响应，SGSN 会向 MS 传递激活（辅助）PDP 上下文接受消息。

根据在此描述的过程，SGSN 和 GGSN 在它们针对 PDP 上下文所创建的 CDR 中添加元组对，而且 CSCF 在其针对呼叫所创建的 CDR 中添加
20 出现在 SIP 信令的媒介特定部分（例如 SDP）中的元组对。

因此，运营商将具有更大的灵活性，去确定如何针对所创建的 CDR 对用户进行计费。运营商可以有选择地省去针对由 GPRS/UMTS 层创建的 CDR 的计费，同时是选择对由 IP 电话层创建的 CDR 进行计费。

图 10 是根据本发明的第四实施例的设计，说明应用层和传输层之
25 间协调的信令流程图。为了能够针对移动台发起的呼叫，对协调或其它类型的信息协调进行计费，在呼叫建立时向 CSCF 发送元组和元组对，而且在 PDP 上下文激活时向 SGSN 和 GGSN 发送元组和元组对。参考图 10，在步骤 1000，MS 为其建议在呼叫中使用的每个所提出的媒介流都分配元组。在 SIP INVITE 的媒介指定（例如 SDP）部分中承载
30 该信息，并且如果远端端点同意使用所提出的媒介，则它被远端端点称作目的元组。MS 在 SIP 邀请消息中，向 CSCF 发送每个所提出媒介流的元组。在该信令之前，如果一个 PDP 上下文也没有被激活，则 MS

至少为呼叫激活一个（通过信令）PDP上下文。媒体协商经过 CSCF 信令链，穿过必需的往返路径，并且起始和终止终端已经得知每个媒体流初始同意的目的和源连接元组（元组对）之后，MS 在激活（辅助）PDP 上下文请求消息中，向 SGSN 发送连接特定的元组对。如幕为呼
5 激活多个 PDP 上下文（多个媒介），MS 必须在每次 PDP 上下文激活时，都向 SGSN 发送分配给特定媒介流的元组对。在步骤 1004，执行无线接入承载的建立。在步骤 1006，SGSN 在创建 PDP 上下文请求消息中，向 GGSN 发送元组对。在步骤 1008 和 1010 中，（辅助）PDP 上下文激活被接受。

10 图 11 根据本发明第四实施例的另一设计，说明应用层和传输层之间协调的信令流程图。图 11 中给出针对移动台终止呼叫的计费协调或其它类型信息协调的实例。参考图 11，在步骤 1100，MS 接收 SIP INVITE 消息。主叫方已经为每个期望的起始或为呼叫动态分配的媒介元素分配了目的地元组取值。在步骤 1102，MS 为呼叫至少激活一个辅助 PDP
15 上下文。MS 在激活（辅助）PDP 上下文请求消息中，向 SGSN 发送元组或元组对。如果为呼叫激活多个 PDP 上下文，MS 必须在每次 PDP 上下文激活时，都要向 SGSN 发送元组或元组对。在步骤 1104，执行无线接入承载的建立。在步骤 1106，SGSN 在创建 PDP 上下文请求消息中，向 GGSN 发送元组对。在步骤 1108 和 1110，（辅助）PDP 上下文激活
20 被接受。

第四实施例中元组对的使用简化了终端层与层之间（应用层 - GPRS/UMTS 层）的处理，并且无论 MS 是 TE + MT 组合或统一的 UE，都可以被有效地使用。这是因为连接特定的 UDP 和 TCP 端口信息会被自动地发送，而不需要针对来自 TE（如第三实施例）的 SIP 消息的特定
25 MT 截获/分析过程，或在 TE 发出的 SIP 消息中添加额外的消息（从 SGSN 接收到的计费 ID）。端口信息在 SIP INVITE 的 SDP 部分或应用层的 ACK 消息中被发送给 CSCF，并且在 PDP 上下文激活请求消息的 TFT 信息中发送给 SGSN 和 GGSN。（被包含到每个 PDP 上下文的 TFT 中的元组对需要被传递到 MT 的 GPRS 会话管理层，这可以例如通过 MT 的实
30 特定承载管理或 QoS 应用程序接口（API）来实现）。

作为第四实施例的变体，在 CSCF - GGSN 的接口端，尽管在 CGR 和帐单中将使用计费 ID 作为标识符，但是可以采用元组对用作关键标识

符, 并且为该标识符分配或链接计费 ID (以及策略认证)。通过为接收机一方 (即准备好接收实时数据的端口) 发送带有逻辑信道信息的呼叫建立消息 (在 SIP: INVITE), 可以在主要 (信令) PDP 上下文之上触发呼叫。CSCF 接收到 INVITE 以及 SDP (以及编码的带宽和端口信息), 并且存储该信息。信令被发送到远端, 该端进行回答 (例如 SIP 18 消息), 而且当前 CSCF 接收一组新的 SDP 信息, 以及由远端 SDP 提供的编译码、带宽以及终止端的目标端口。CSCF 对从来自双方终端的 SIP 消息中接收到的编译码类型数据进行检验, 这将生成经过协商的编译码组, 对每个 IP 连接来说, 其目标 [IP 地址、端口] 元组取值是已知的, CSCF 应该验证。

CSCF 能够利用 CSCF-PCF-GGSN 接口 (或者如果 PCF 被集成在 CSCF 中, 则是 CSCF-GGSN), 去请求策略控制行为 (带宽认证) 以及在层之间进行计费协调, 并且以元组作为关键。GGSN 承认带宽, 并且随后在辅助 PDP 上下文激活过程期间, 为所创建的与关键元组取值相关的 PDP 上下文分配计费 ID, 并且将计费 ID 返回 CSCF, 用于对协调进行计费。CSCF 不需要去分析来自接收的 SIP 消息的计费 ID, 由于不能篡改并且修改从 TE 接收到的任何 SIP 消息, 因此不存在恶意 MT 的危险性。相反, 它可以将由 GGSN 所发送的计费 ID 与端口信息相关。

由于 CSCF 会注意到最后信令中的动态变化的输出, 并且会请求新的认证以及获得新的计费 ID, 因此如果 TE 发送带有变化 QoS/编译码信息的 RE-INVITE 消息, 则在第四实施例, 为运营商所提供的计费灵活性可以进一步改进。而且, 可以创建新的计费 ID, 使得可以针对每条新动态添加的实时 PDP 上下文/媒介流的记录进行计费。如果实时流在 PDP 层要利用 RTP/UDP/IP 头压缩, 则每个媒介流需要其自己的 PDP 上下文。这样, 如果需要的话, 运营商计费能够在端到端的呼叫中, 遵循媒介的变化 (音频到视频电话再到音频等)。遵循本发明中第三实施例中描述的过程, 如果例如运营商决定省去 SGSN 和 GGSN CDR, 则呼叫 ID 不会发生变化, 并且在计费信息中不会指示媒介特定连接的细节。

应该可以注意到, 在本发明的上述描述过程中, 为了简便, 本领域内的技术人员公认已知的各种细节已经被省略了。这些细节可以容易地在各种公开发表的资料, 包括上述引用的协议中找到。

尽管是参考多个说明性实施例来描述本发明，但是应该理解到，本领域的技术人员可以作出各种其它修改和实施例，它们都处于本发明的精神实质和覆盖范围之内。更加具体而言，在组成部分和/或主题合并设计的设计中可以作出合理的变化和修改，而处于上述公开阐述、附图以及附加权利要求的范围之内，没有脱离本发明的精神实质。除了

5 除了在组成部分和/或设计中作出各种变化和修改之外，对本领域的技术人员来说，其它应用也是很明显的。



图 1



图 2

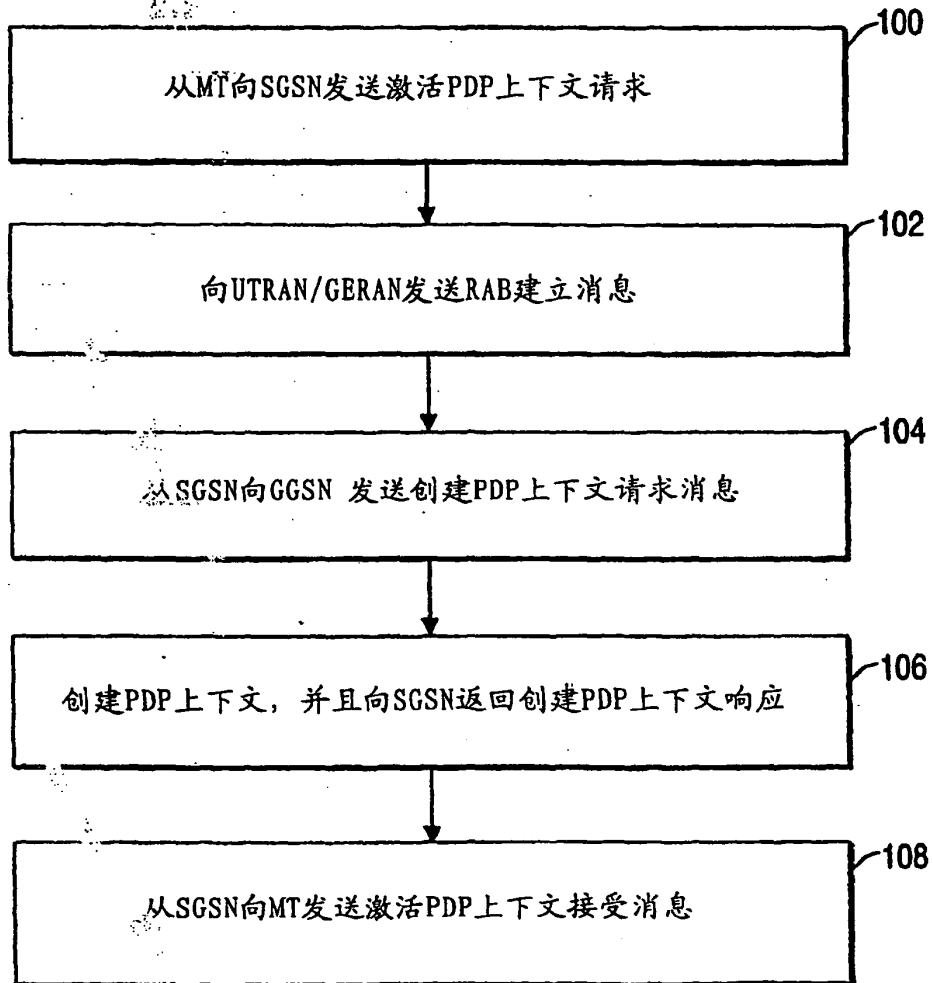

图 3

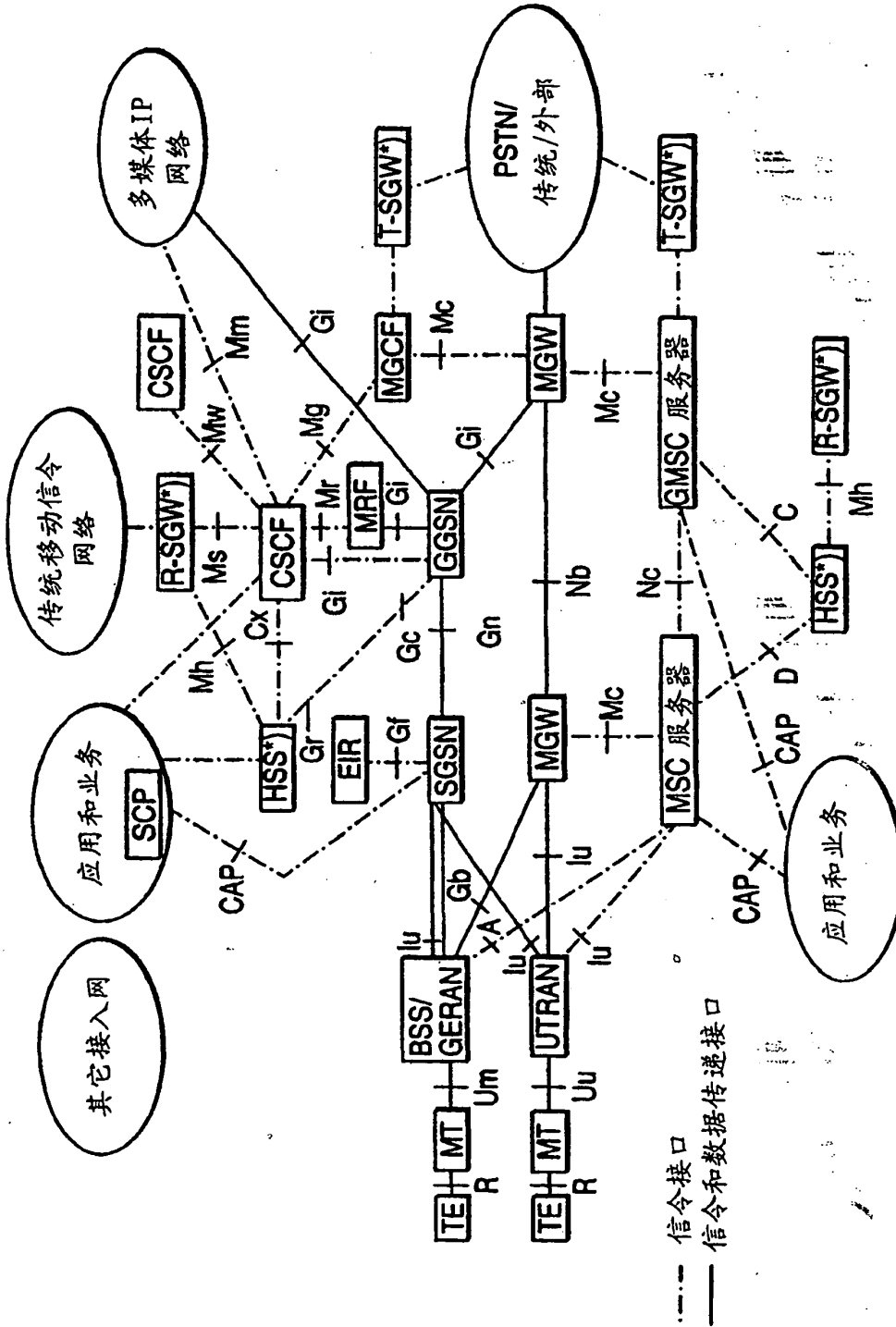

图 4

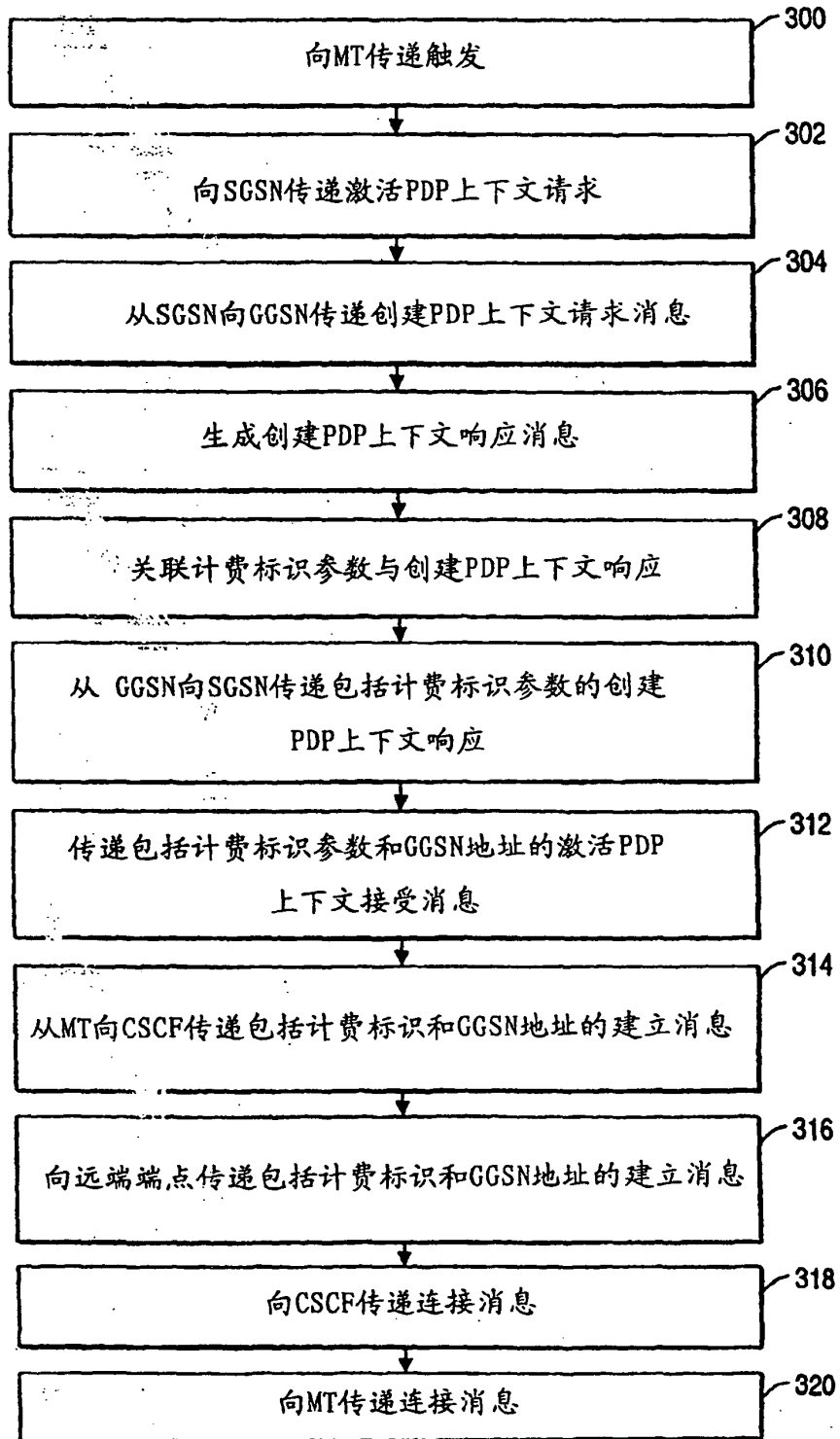

图 5



图 6

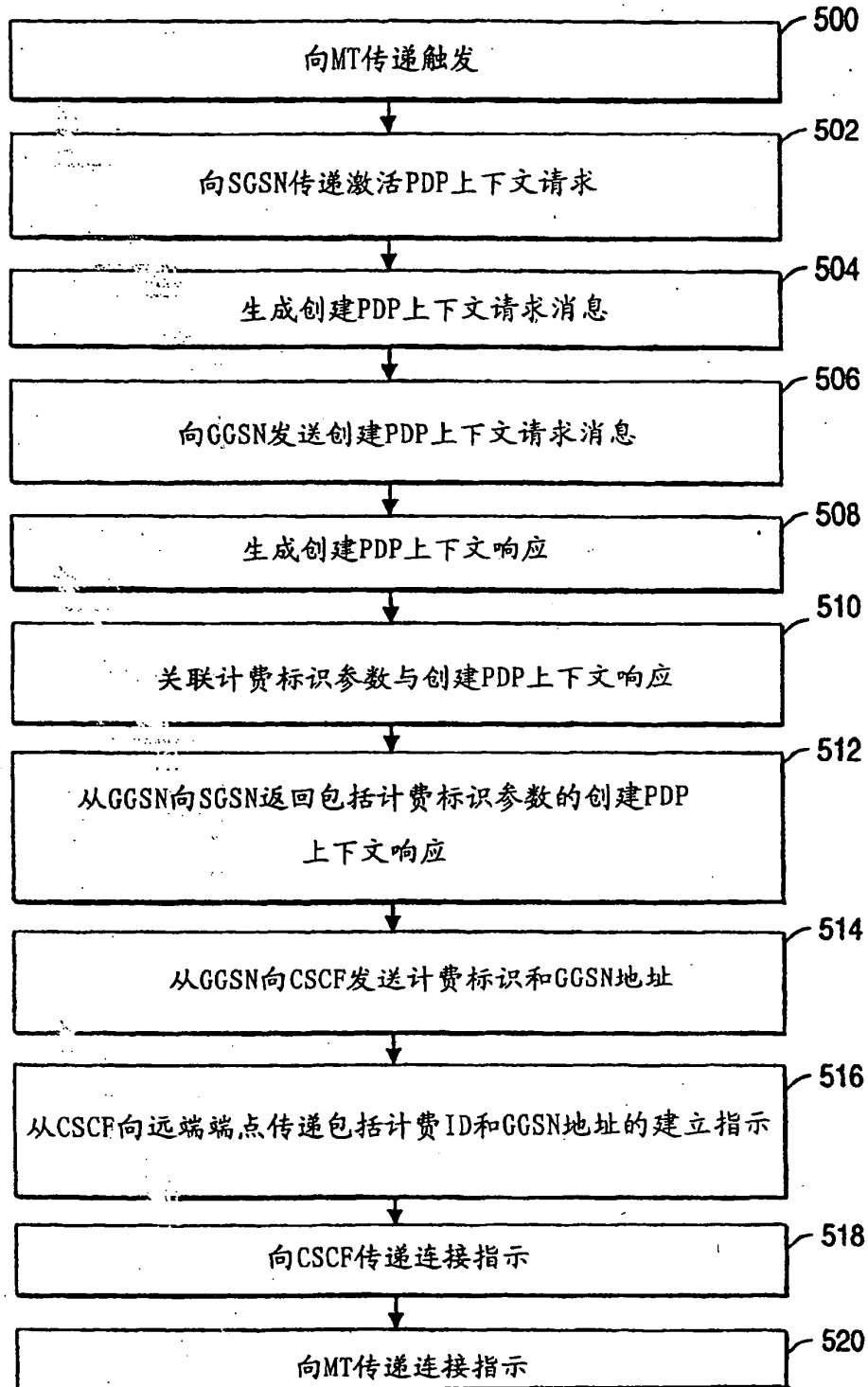

图 7

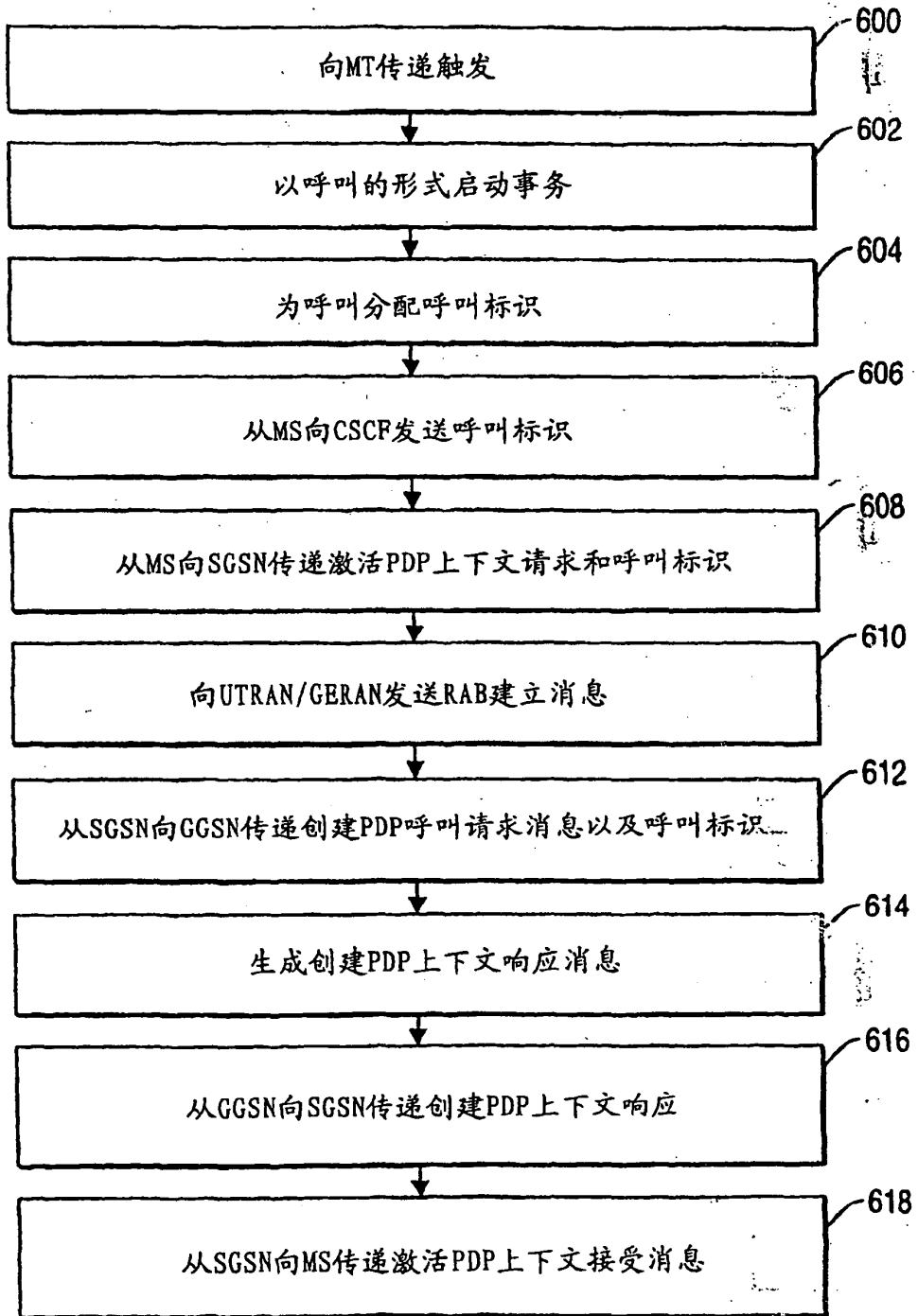

图 8

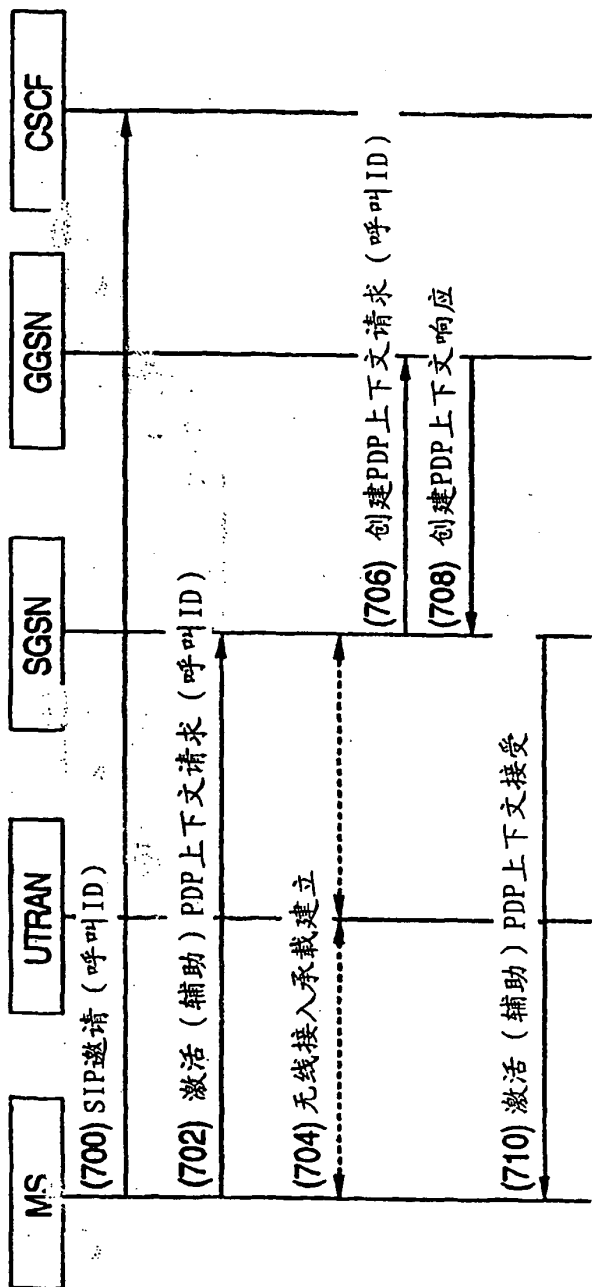

图 9

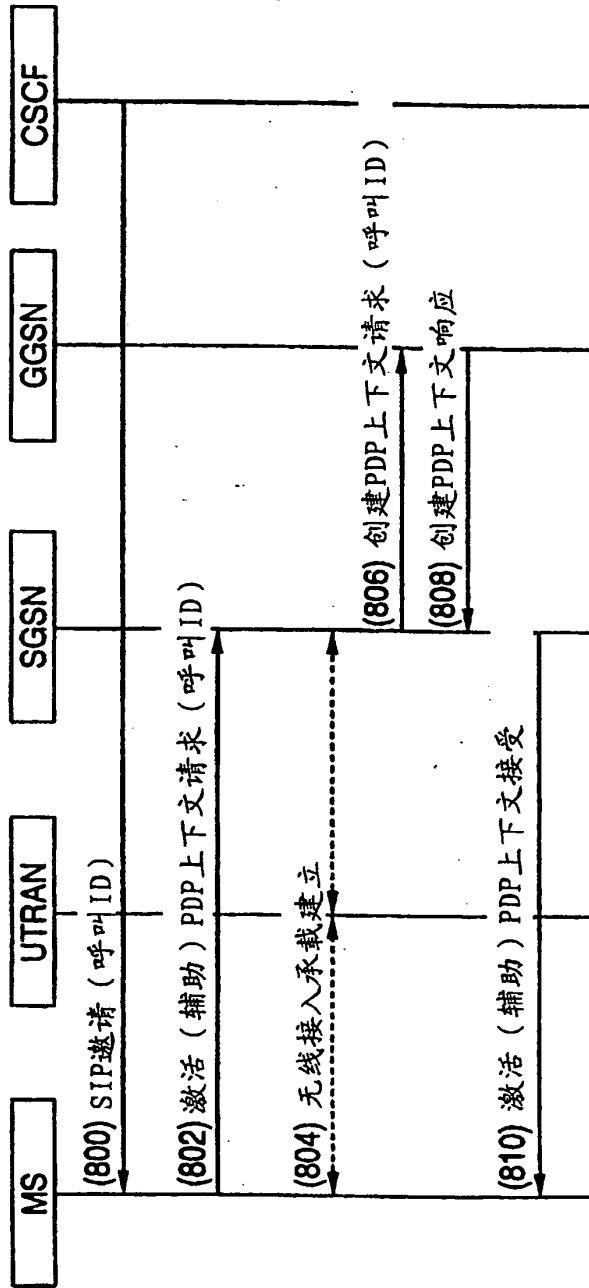

图 10

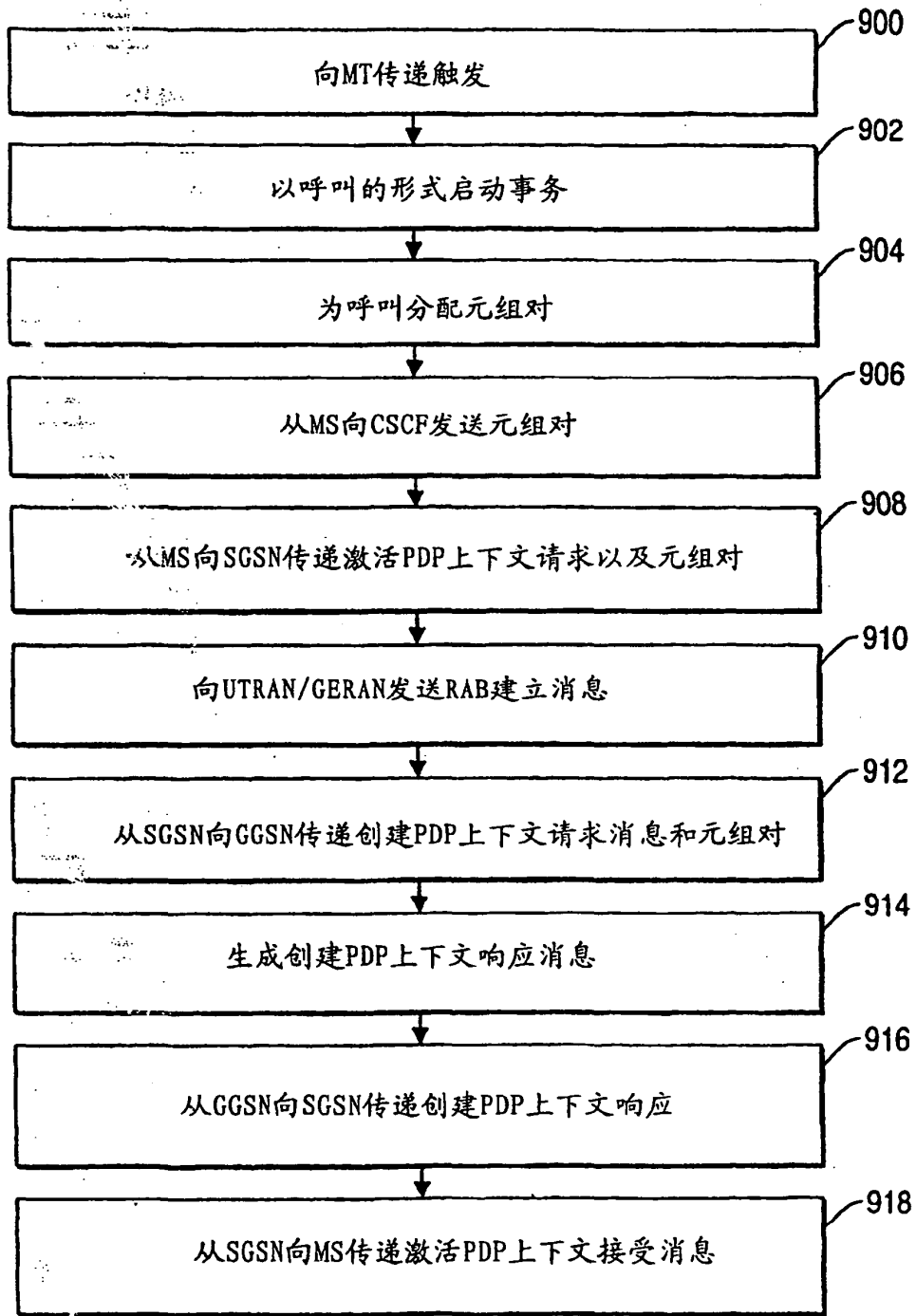

图 11

Method for unified managing resource in packet network of PLMN

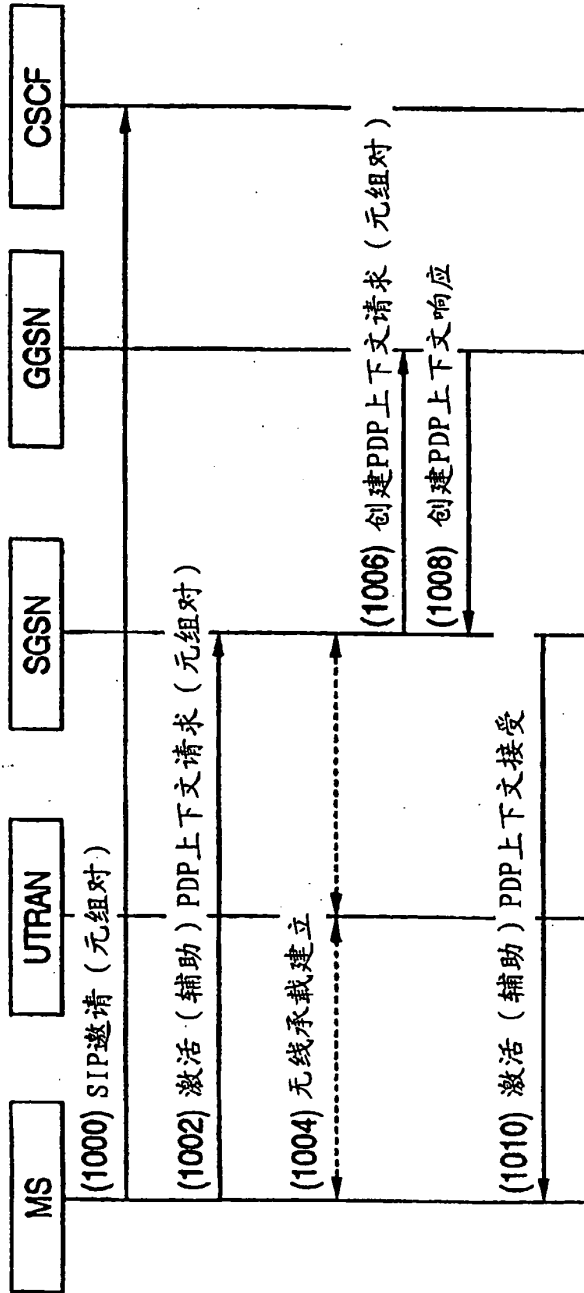
Publication number: CN1452333 (A)

Publication date: 2003-10-29

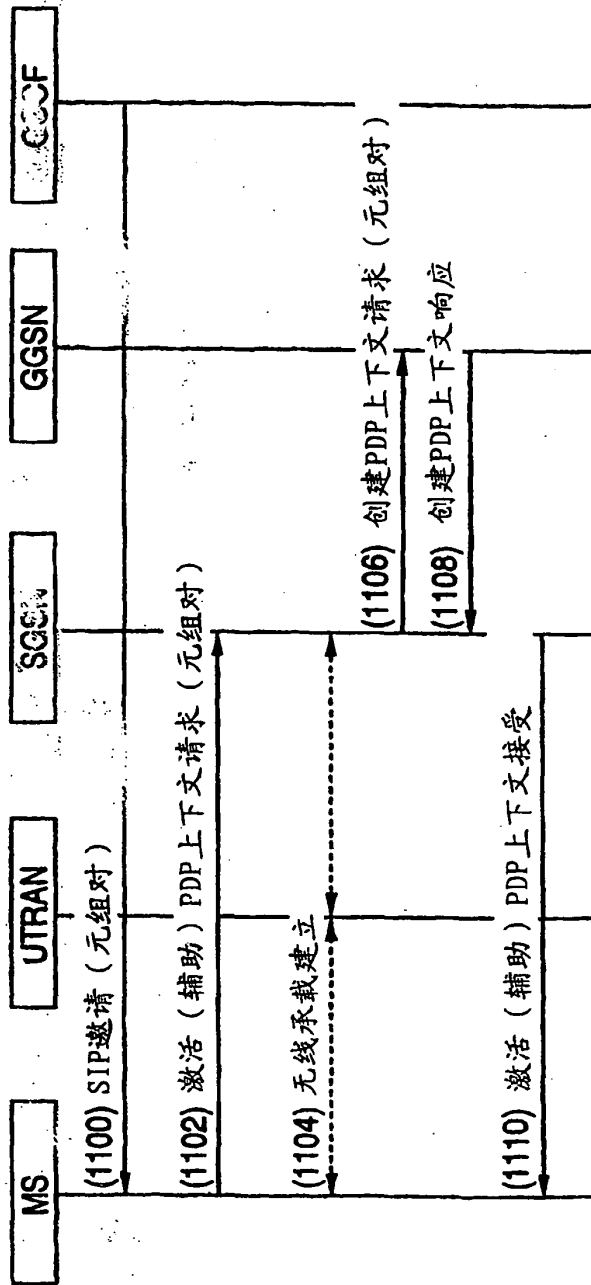
Inventor(s): CHEN CHENG [CN]

Applicant(s): HUAWEI TECH CO LTD [CN]

Classification:

- international: *H04J13/00; H04L12/24; H04Q7/20; H04J13/00; H04L12/24; H04Q7/20; (IPC1-7): H04J13/00; H04L12/24; H04Q7/20*

- European:

Application number: CN20021011352 20020415

Priority number(s): CN20021011352 20020415

Also published as:

 CN1214555 (C)

Abstract of CN 1452333 (A)

A united resource management method for the packet network of public land mobile network (PLMN) is characterized by that a GGSN manager center (GMC) for united management of whole network resource is additionally used in original WCDMA/GPRS system and the activating flow, update flow and deletion flow are relatively modified to realize the GPRS/GGSN accessing users management, GGSN bandwidth management, access point name (APN) management, IP address management, and APN charge management.

Data supplied from the *esp@cenet* database — Worldwide

[19] 中华人民共和国国家知识产权局

[51] Int. Cl⁷

H04J 13/00

H04Q 7/20 H04L 12/24



[12] 发明专利申请公开说明书

[21] 申请号 02111352.1

[43] 公开日 2003 年 10 月 29 日

[11] 公开号 CN 1452333A

[22] 申请日 2002.4.15 [21] 申请号 02111352.1

[71] 申请人 华为技术有限公司

地址 518057 广东省深圳市科技园科发路华为用户服务中心大厦

[72] 发明人 陈 诚

[74] 专利代理机构 上海市华诚律师事务所

代理人 徐申民

权利要求书 2 页 说明书 7 页 附图 3 页

[54] 发明名称 公共陆地移动网 (PLMN) 分组网中统一管理资源的一种方法

[57] 摘要

本发明涉及到宽带码分复用 (WCDMA)/通用分组无线业务 (GPRS) 移动通信领域, 公共陆地移动网 (PLMN) 分组网中统一管理资源的一种方法。该方法在原有的 WCDMA/GPRS 系统中增加一个对全网资源统一管理的设备 GMC (GGSN Manage Center), 并相应增改了系统的激活流程、更新流程和删除流程, 实现通用分组无线业务网关支持点 (GGSN) 接入用户数管理、GGSN 带宽管理、接入点名称 (APN) 管理、IP 地址管理、APN 计费管理等, 有效解决运营商对 PLMN 资源的管理问题, 提供给运营商一种集中高效的运营管理方法, 有效提高网络资源利用率, 方法简单实用。

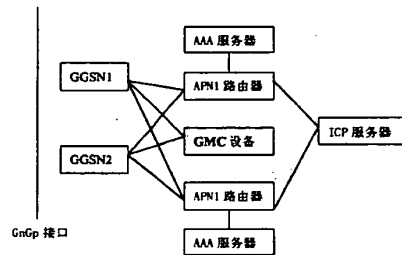

ISSN 1008-4274

知识产权出版社出版

1、公共陆地移动网 (PLMN) 分组网中统一管理资源的一种方法, 其特征在于, 在原有的宽带码分复用 (WCDMA) /通用分组无线业务 (GPRS) 系统中增加一个对全网资源统一管理的设备 GMC(GGSN Manage Center), 增改了系统的流程, 具体步骤如下:

a) 激活

a-1) 用户激活上下文, GGSN 请求 AAA 服务器对用户进行鉴权;

a-2) 鉴权通过后, GGSN 向 GMC 发送资源请求消息, 消息内容至少包括: 用户标识、GGSN 标识、GGSN 地址、主叫号码 (MSISDN 或 IMSI)、APN、用户请求 QOS、是否分配动态地址;

a-3) GMC 处理请求消息;

a-4) 如果用户接入的 APN 不能满足要求, 则 GMC 返回给 GGSN 失败消息, 失败消息内容至少包括用户标识和失败原因, GGSN 收到失败应答消息后, 返回用户激活失败;

a-5) 否则, 返回成功消息, 消息内容至少包括: 用户协商后的 QOS、动态 IP 地址、是否二次计费及计费方式、与用户相关的 APN 信息或者权限, GGSN 收到成功消息后, 通知 AAA 服务器开始计费, 再返回成功应答给用户, 激活完成;

a-6) 结束。

b) 更新

b-1) GGSN 接收到上下文更新请求, 把与计费相关的信息上报给 AAA 服务器;

b-2) 如果用户请求 QOS 更新, 需要通知 GMC 检查 APN 是否能满足更新要求; 如果 GMC 正在对用户进行二次计费, 需要把计费相关的信息上报给 GMC, 更新时 GGSN 发给 GMC 的消息内容至少包括: 用户标识、GGSN 标识、GGSN 地址、主叫号码、APN、用户请求 QOS;

b-3) 若 APN 满足要求, GMC 给 GGSN 返回成功应答, 消息内容至少包括用户标识和协商后的 QOS;

b-4) 否则, 返回失败应答给 GGSN, 消息内容至少包括用户标识和失败原因;

b-5) 结束。

c) 删除

c-1) 上下文删除时, GGSN 上报给 GMC, 上报消息内容至少包括用户标识、GGSN 标识、GGSN 地址、主叫号码、APN、用户使用的 QOS、用户使用的 IP 地址;

c-2) GMC 释放用户的 IP 地址; 重新统计 APN 的用户数和使用的带宽; 统计记录用

户接入 APN 的情况, 作为对 APN 运营者收费的依据; 返回应答给 GGSN, 消息内容至少包括用户标识和是否正常删除;

c-3) 结束。

2、如权利要求 1 所述的 PLMN 分组网中统一管理资源的一种方法, 其进一步特征在于, 所述 GMC, 位于系统的核心网上, 连接各个 GGSN。

3、如权利要求 1 所述的 PLMN 分组网中统一管理资源的一种方法, 其进一步特征在于, 所述 GMC 处理请求消息包括如下步骤:

1) 统计接入 APN 的用户数, 并检测是否超过“批发”的用户数, 超过则拒绝接入此 APN 的用户激活;

2) 对用户请求 QOS 协商, 根据协商后 QOS, 统计接入 APN 的带宽, 并检测是否超过“批发”的带宽, 如果超过则拒绝用户接入此 APN;

3) 给用户分配 IP 地址;

4) 对用户使用 APN 的信息进行记录, 以便对 APN 收费;

5) 根据 APN 基本信息, 返回用户访问此 APN 的方式和权限, 如计费方式、用户能使用的业务等;

6) 结束。

4、如权利要求 1 所述的 PLMN 分组网中统一管理资源的一种方法, 其进一步特征在于, 所述 GMC 和 GGSN 之间通讯, 采用超时重发机制以及加密或者隧道技术。

5、如权利要求 1 所述的 PLMN 分组网中统一管理资源的一种方法, 其进一步特征在于, 所述 GMC 包含有 Portal 服务器, PUSH 业务域名服务器以及 AAA 服务器。

6、如权利要求 1 所述的 PLMN 分组网中统一管理资源的一种方法, 其进一步特征在于, 所述 GGSN 在正常运营期间向 GMC 发送握手消息, 消息内容包括 GGSN 标识和 GGSN 地址。

7、如权利要求 1 所述的 PLMN 分组网中统一管理资源的一种方法, 其进一步特征在于, 所述 GGSN 在启动后, 向 GMC 发送开始正常运营消息, 消息内容包括 GGSN 标识和 GGSN 地址。

8、如权利要求 1 所述的 PLMN 分组网中统一管理资源的一种方法, 其进一步特征在于, 所述 GGSN 在重启前, 向 GMC 上报此异常事件, 消息内容包括 GGSN 标识和 GGSN 地址。

公共陆地移动网 (PLMN) 分组网中统一管理资源的一种方法

技术领域

本发明涉及到宽带码分复用 (WCDMA) /通用分组无线业务 (GPRS) 移动通信领域,尤其是对网络资源进行管理。

背景技术

在 WCDMA/GPRS 系统中,移动运营商联合接入点名称 (APN) 运营者为移动用户提供高速分组传输业务。分组无线业务网关支持点 (GGSN) 设备作为 PLMN 中移动用户接入外部分组数据网 APN (包括 ISP、Internet、企业用户、PLMN 的专用网等) 的接入设备,主要包括用户会话管理、用户数据管理、数据转发和计费、接入外部数据网等功能; APN 提供外部分组数据的承载功能和接入应用服务器的功能。它们在网络中位置如图 1 所示。在用户上网时, GGSN 负责到 APN 的 AAA 服务器对用户鉴权, 分配属于 APN 地址空间的动态 IP 地址, 建立和 APN 的连接通道, 生成用户上下文, 成功完成后, 用户可以正常的上网; 用户上网过程中, GGSN 负责用户数据的转发及计费信息的收集; 用户下网时, 回收用户 IP 地址, 断掉用户链接。

在现在的 WCDMA/GPRS 网络中, 主要有以下问题存在。

1、在一个网络中为方便用户接入, 有多个 GGSN 分布在全网的不同地方, 通过这些 GGSN 都能接入到同一个 APN, 如果 APN 很多, 这种接入是十分复杂的, 目前移动运营商缺少一种对 APN 进行全网管理的有效方法, 如管理通过移动网络可以接入哪些 APN、这些 APN 的属性等信息。在一个 GGSN 设备上也可以对接入到这个 GGSN 的 APN 进行管理, 但这种管理是局部的, 不完善的。

2、一个网络通过 GGSN 提供的接入能力, 包括用户数和总的带宽, 都是有限的, 移动运营商对网络进行有效运营管理的方法是把些接入能力“批发”给各个 APN (主要是 ISP)。类似于固网, 移动运营商关注于无线接入, ISP 关注于分组接入和提供业务, 共同分享利益。但目前网络上缺少对所有 GGSN 的接入用户数和带宽进行管理批发的方法。如果让每个 APN 拥有一个 GGSN, 也是不经济合理的。

3、用户通过 GGSN 接入一个 APN 时, 需要为用户分配动态 IP 地址, 目前的 IP 地址

都是各个 GGSN 设备分别管理 APN 的地址空间的一部分，地址利用率较低。在 APN 的地址空间地址紧缺时，全网统一管理 IP 地址能增加利用率，目前缺少一种能在全网对 APN 的地址空间进行分配回收管理的方法。

4、移动运营商给 APN 运营者提供无线网络接入功能，移动运营商需要向 APN 运营者收取一定的费用。目前的计费方法是移动运营商和 APN 运营者分别对用户计费，APN 运营者按月付费给运营商，或者由移动运营商对用户统一计费，再按比例分成给 APN 运营者，这种计费方式是一种粗略的计费，移动运营商缺少对 APN 精确收费的方法，如根据用户接入 APN 的实际使用情况向 APN 收费。

发明内容

本发明的目的是提供一种在 WCDMA/GPRS 网络中对资源进行统一管理方法，统一管理的能力包括 APN 管理、IP 地址管理、GGSN 接入用户数和带宽管理、对 APN 计费等。具体技术方案如下。

(一) 系统功能描述：

在 WCDMA/GPRS 系统中增加一个对全网资源统一管理的设备 GMC (GGSN Manage Center)，该设备在网络中位置如图 2 所示。

GMC 设备主要完成功能包括：

1、用户数管理：

对 GGSN 的最大接入用户数，以及“批发”给各 APN 的最大接入用户数进行统一管理。当接入 APN 的用户数超过最大允许数时，拒绝该 APN 新用户接入。移动运营商按照“批发”用户数方式向 APN 运营者收费，提高 GGSN 接入用户数能力的利用率。

2、带宽管理：

对 GGSN 的最大接入带宽，以及“批发”给各 APN 的最大带宽进行统一管理。当接入 APN 的用户使用的总带宽超过最大允许数时，拒绝该 APN 的新用户接入。移动运营商按照“批发”的用户数向 APN 运营者收费，提高 GGSN 接入带宽能力的利用率。

APN 带宽的计算方法：在用户激活上下文和更新上下文时，需要和 GGSN 协商 QOS，GMC 根据用户协商后的 QOS (包括用户使用的带宽) 累计，可以得出 APN 使用的总带宽。QOS 的定义参加 3GPP 协议规定。

3、APN 管理：

对通过移动网络接入的 APN 进行统一的维护管理和统计。APN 维护管理包括 APN

的基本信息管理、APN和GGSN的连接关系管理、提供业务能力管理等，这里和HLR中对APN的管理区别是：HLR主要管理APN的签约信息；APN统计包括APN的业务量统计、个人用户的业务量统计等；结合用户数“批发”和带宽“批发”功能，为运营商提供一种方法实现灵活的运营管理策略。

4、IP地址管理：

对APN的IP地址空间进行统一管理，在激活时为用户分配IP地址，去活时回收IP地址，提高IP地址利用率。

5、对APN计费：

对用户使用外部分组数据网资源的情况进行统计和记录，包括用户接入APN的历史记录，用户接入APN的流量、时间段统计，及记录其它能用于对APN计费的信息。这些信息用于对APN运营者收费的依据。

6、GGSN设备的使用情况和状态监控功能：

7、还可以包含Portal服务器功能、PUSH业务域名服务器功能、AAA服务器功能等。

(二) 流程说明：

完成以上描述的功能对系统原有的激活、更新、去活流程有一定影响，需要改变流程以支持新的功能，新的流程如下（没有涉及的流程默认不变）：

1、如图3所示，激活流程说明如下：

(1) 用户激活上下文，GGSN请求AAA服务器对用户进行鉴权；

(2) 鉴权通过后，GGSN向GMC发送资源请求消息，消息内容至少包括：

用户标识

GGSN标识

GGSN地址

主叫号码（MSISDN或IMSI）

被叫号码（APN）

用户请求QoS

是否分配动态地址

(3) GMC处理请求消息的功能包括：

a、统计接入APN的用户数，并检测是否超过“批发”的用户数，超过则拒绝接入此APN的用户激活；

b、对用户请求QoS协商，根据协商后QoS，统计接入APN的带宽，并检测是否超

过”批发“的带宽，如果超过则拒绝用户接入此 APN；

c、给用户分配 IP 地址；

d、对用户使用 APN 的信息进行记录，以便对 APN 运营商收费；

e、根据 APN 基本信息，返回用户访问此 APN 的方式和权限，如计费方式、用户能使用的业务等。

(4) 如果用户接入的 APN 不能满足要求，则 GMC 返回给 GGSN 失败消息，失败消息内容至少包括：

用户标识

失败原因

(5) 否则，返回成功消息，消息内容至少包括：

用户协商后的 QoS

动态 IP 地址

是否二次计费及计费方式

与用户相关的 APN 信息或者权限

(6) GGSN 收到失败应答消息后，返回用户激活失败；否则通知 AAA 服务器开始计费，再返回成功应答给用户。激活完成。

2、如图 4 所示，更新流程说明如下：

(1) GGSN 接收到上下文更新请求，把与计费相关的信息上报给 AAA 服务器；

(2) 如果用户 QoS 更新，需要通知 GMC 检查 APN 是否能满足更新要求；如果 GMC 正在对用户进行二次计费，需要把计费相关的信息上报给 GMC，更新时 GGSN 发给 GMC 的消息内容至少包括：

用户标识

GGSN 标识

GGSN 地址

主叫号码 (MSISDN 或 IMSI)

被叫号码 (APN)

用户请求 QoS

(3) 若 APN 满足要求，GMC 给 GGSN 返回成功应答，消息内容至少包括：

用户标识

协商后的 QoS

(4) 否则, 返回失败应答给 GGSN, 消息内容至少包括:

用户标识

失败原因

3、如图 5 所示, 删除流程说明如下:

(1) 上下文删除时, GGSN 上报给 GMC, 上报消息内容至少包括:

用户标识

GGSN 标识

GGSN 地址

主叫号码 (MSISDN 或 IMSI)

被叫号码 (APN)

用户使用的 QoS

用户使用的 IP 地址

(2) GMC 释放用户的 IP 地址; 重新统计 APN 的用户数和使用的带宽; 统计记录用户接入 APN 的情况, 作为对 APN 运营者收费的依据; 返回应答给 GGSN, 消息内容至少包括:

用户标识

是否正常删除

(三) GGSN 和 GMC 设备间通讯:

1、通讯可靠性和安全性:

在 GGSN 和 GMC 之间通讯, 可采用超时重发机制确保可靠性;

可以使用加密或者隧道技术保证信息的安全性;

2、设备间维护消息:

GGSN 正常运营期间定期向 GMC 发送握手消息, 消息内容包括:

GGSN 标识

GGSN 地址

GGSN 在启动后, 向 GMC 发送开始正常运营消息, 消息内容包括:

GGSN 标识

GGSN 地址

GGSN 在重启前, 向 GMC 上报此异常事件, 消息内容包括:

GGSN 标识

GGSN 地址

本发明方法的效果是：能有效解决运营商对 PLMN 资源的管理问题，提供给运营商一种集中高效的运营管理方法，有效提高网络资源利用率，方法简单实用。

附图说明

图 1 原有技术实现网络资源管理。

图 2 本发明实现网络资源统一管理。

图 3 本发明的激活流程。

图 4 本发明的更新流程。

图 5 本发明的删除流程。

具体实施方式

在 WCDMA/GPRS 系统中增加一个对全网资源统一管理的设备 GMC, 即 GGSN Manage Center, 该设备在网络中的核心网上, 连接各个 GGSN。同时系统原有的激活、更新、删除流程均不能满足要求, 因此配合 GMC, 也对系统流程进行了增改。

当用户提出上网请求时, GGSN 接收到激活上下文请求消息, 向 AAA 服务器请求对用户进行鉴权。鉴权通过后, GGSN 向 GMC 发送资源请求消息, 如用户标识、GGSN 标识、GGSN 地址、主叫号码、用户请求 QOS 和是否分配动态地址。此时, GMC 对请求信息进行判断, 即是否让用户接入。比如, GMC 对于接入 APN 的用户数进行统计, 并检测是否超过“批发”的用户数。当接入 APN 的用户数超过最大允许数时, 则拒绝该 APN 新用户接入, 这样移动运营商按照“批发”用户数方式向 APN 运营者收费, 提高 GGSN 接入用户数能力的利用率。又比如, GMC 对于用户请求 QOS 协商, 根据协商后 QOS, 统计接入 APN 的带宽, 并检测是否超过“批发”的带宽。当接入 APN 的用户使用的总带宽超过最大允许数时, 拒绝该 APN 的新用户接入, 这样移动运营商按照“批发”的用户数向 APN 运营者收费, 提高 GGSN 接入带宽能力的利用率。

如果用户接入的 APN 满足要求, 即接入 APN 的用户数未达到最大允许数, 接入 APN 的带宽也未超过最大允许数, 则 GMC 将给用户分配 IP 地址, 对用户接入 APN 的信息进行记录, 作为对 APN 计费的依据, 并根据 APN 基本信息, 返回用户访问此 APN 的方式和权限, 如计费方式、用户能使用的业务。GMC 返回给 GGSN 成功消息, 消息内容包括用户协商后的 QOS、动态 IP 地址、是否二次计费及计费方式和与用户相关的 APN 信息

或者权限，此时用户处于激活状态。此时，GMC 开始对 APN 计费，包括用户接入 APN 的流量、时间段统计，并监控 GGSN 设备的使用情况和状态。

当用户 QOS 更新，GGSN 发给 GMC 的消息内容包括用户标识、GGSN 标识、GGSN 地址、主叫号码、被叫号码以及用户请求 QOS，此时需要通知 GMC 检查 APN 是否能满足更新要求，即接入 APN 的用户数是否达到最大允许数以及接入 APN 的带宽是否超过最大允许数。如果接入 APN 的用户数未达到最大允许数，接入 APN 的带宽也没有超过最大允许数，则 GMC 给 GGSN 返回成功应答，如用户标识和协商后的 QOS 信息，用户更新成功；否则，GMC 给 GGSN 返回失败应答，如用户标识和失败原因信息，用户更新失败。

当用户下网时，GGSN 上报给 GMC 诸如用户标识、GGSN 标识、GGSN 地址、主叫号码、被叫号码、用户使用的 QOS 以及用户使用的 IP 地址消息，此时 GMC 释放用户的 IP 地址，提高了 IP 地址的利用率，并重新统计 APN 的用户数和使用的带宽，统计记录用户接入 APN 的情况，作为对 APN 运营者收费的依据，返回应答给 GGSN，包括用户标识和是否正常删除的信息。



图 1



图 2

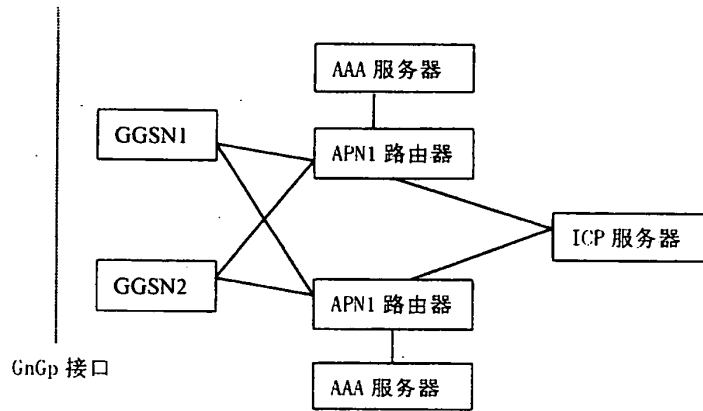

图 3

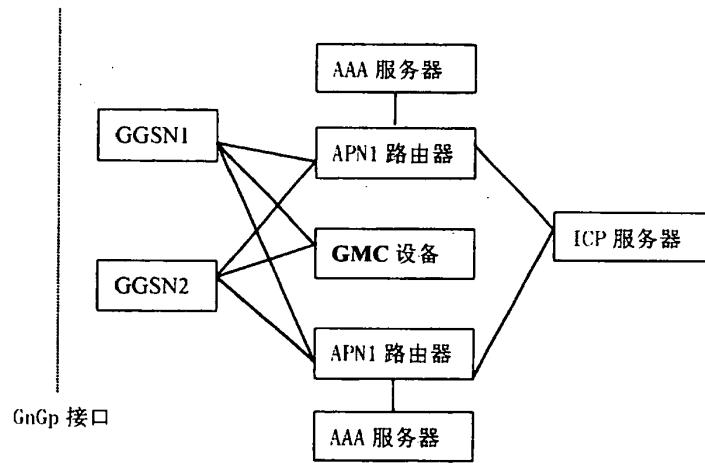

图 4

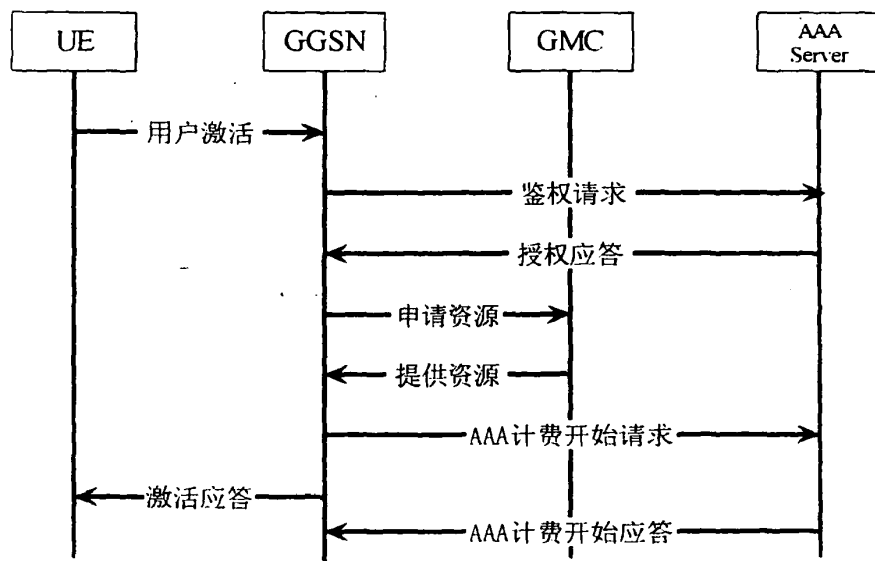

图 5

Method for realizing payment for calling/called payment on intellectual network

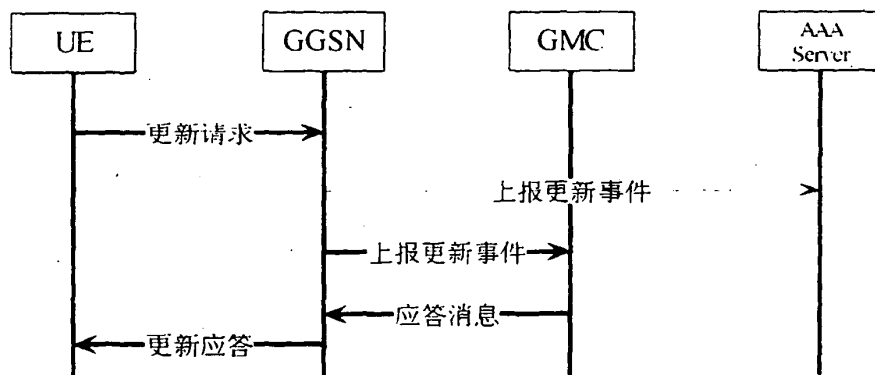
Publication number: CN1472920 (A)
Publication date: 2004-02-04
Inventor(s): LIU YONG [CN]
Applicant(s): HUAWEI TECH CO LTD [CN]
Classification:

- **international:** *H04L12/14; H04M3/42; H04L12/14; H04M3/42;* (IPC1-7): H04L12/14; H04M3/42

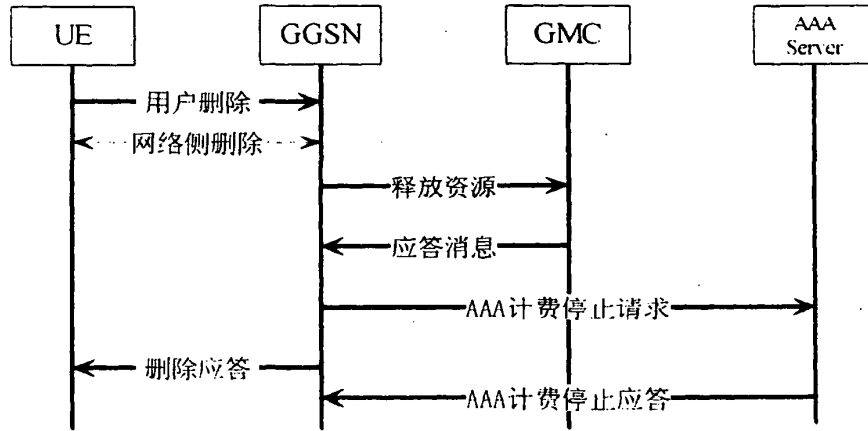
- **European:**

Application number: CN20021036361 20020802

Priority number(s): CN20021036361 20020802

Also published as:

 CN1241355 (C)

Abstract of CN 1472920 (A)

The present invention provides a method for realizing the business of charging calling party or called party through a specific calling instruction procedure in the mobile intelligent network. Using the mobile intelligent network, the invention can determine whether calling party or called party would be charged or share-partly charged according to a switch-in code plus a called number dialed by a user. Because the intelligent network can be used, the business of charging calling or called parties can facilitate the individual users and the group users of whole network owing to its flexible charge using the intelligent network and its flexible customizing business property. The business of charging calling or called parties can be actuated using either switch-in codes or number segments, or using the combination of the two, as well as using the signing information of the target network.

Data supplied from the *esp@cenet* database — Worldwide

[19] 中华人民共和国国家知识产权局

[51] Int. Cl⁷

H04L 12/14

H04M 3/42



[12] 发明专利申请公开说明书

[21] 申请号 02136361.7

[43] 公开日 2004年2月4日

[11] 公开号 CN 1472920A

[22] 申请日 2002.8.2 [21] 申请号 02136361.7

[71] 申请人 华为技术有限公司

地址 518057 广东省深圳市科技园科发路华为用户服务中心大厦

[72] 发明人 刘 勇

[74] 专利代理机构 上海市华诚律师事务所

代理人 徐申民

权利要求书2页 说明书7页 附图4页

[54] 发明名称 一种在智能网上实现主被叫付费业务的方法

[57] 摘要

本发明提供一种在移动智能网上通过特定的呼叫信令流程实现主被叫付费业务的方法。本发明可利用移动智能网实现用户拨打不同的接入码加被叫号码来决定呼叫是由主叫付费，或是由被叫付费，或是一部分由主叫付费、其余部分由被叫付费。主被叫付费业务可利用智能网计费灵活、业务特征可灵活定制的特点方便地为全网个人、集团用户提供服务。主被叫付费业务可以采用接入码触发或者号段触发或者接入码加号段触发，也可以采用目标网签约信息触发。

I S S N 1 0 0 8 - 4 2 7 4

知识产权出版社出版

1. 一种在移动智能网上实现主被叫付费业务的方法，其特征在于，所述方法包括以下步骤：
 - 1) 用户通过拨打被叫号码的方式或者通过拨打业务接入码加被叫号码的方式进行呼叫；
 - 2) 主叫方移动交换中心 (MSCa) 收到呼叫后通过一种触发方式触发业务，向主叫用户的业务控制点 (SCP) 发送初始事件上报 (IDP) 消息；
 - 3) SCP 根据主叫位置和被叫号码确定主叫用户的费率并折算成通话时长，向 MSCa 发送配置 EDP (Event Detection Point) 事件 (RRBE)、下发计费信息 (AC) 和下发接续操作 (Connect)；
 - 4) MSCa 收到 Connect 消息后向被叫用户的归属位置寄存器 (HLR) 发送获取用户漫游号码 (SRI) 消息，取得其相应于触发方式的信息和被叫位置信息 (Location Information)；
 - 5) MSCa 向 SCP 发送 IDP 消息，并将 MSCa 所在位置的长途区号放在 IDP 消息中的 Location Number 参数中，将 Location Information 放在 IDP 消息中的 Location Information 参数中；
 - 6) SCP 收到 IDP 消息后分析被叫用户帐户，若帐户有效则 SCP 根据资费政策和从 IDP 得到的被叫位置信息 Location Information 确定被叫费率并折算成通话时长，向 MSCa 发送 RRBE、AC 和 connect；
 - 7) MSCa 向被叫方 HLR 再次发送 SRI 消息，得到被叫的漫游号码 (MSRN)；
 - 8) MSCa 根据被叫的漫游号码 MSRN 进行接续；
 - 9) 主、被叫任一方挂机，MSCa 向 SCP 上报计费报告 (ApplyCharging Report) 和挂机事件 (ERB)；
 - 10) SCP 下发释放呼叫 (ReleaseCall) 消息，结束呼叫。
2. 如权利要求 1 所述的一种在移动智能网上实现主被叫付费业务的方法，其特征在于，主叫方移动交换中心 (MSCa) 同时具有业务交换点 (SSP) 和用户拜访位置寄存器 (VLR) 的功能。
3. 如权利要求 1 所述的一种在移动智能网上实现主被叫付费业务的方法，其特征在于，

被叫位置信息 (Location Information) 包含用户拜访位置寄存器信息 (Vlr-number)。

4. 如权利要求 1 所述的一种在移动智能网上实现主被叫付费业务的方法, 其特征在于, 用户拨打业务接入码加被叫号码进行呼叫时, 系统根据其不同的业务接入码可设置成对被叫方计费、对主叫方计费以及对主被叫方分摊计费。
5. 如权利要求 1 所述的一种在移动智能网上实现主被叫付费业务的方法, 其特征在于, 其采用的触发方式包括接入码触发、号段触发、接入码加号段触发、以及目标网签约信息触发。
6. 如权利要求 1 所述的一种在移动智能网上实现主被叫付费业务的方法, 其特征在于, 系统提供包括添加可接入号码、删除可接入号码、允许全部接入、禁止全部接入的维护操作。

一种在智能网上实现主被叫付费业务的方法

技术领域

本发明涉及移动通信领域，尤其涉及一种在移动智能网上实现主被叫付费业务的方法。

背景技术

移动智能网是在移动网络中引入智能网功能实体，以完成对移动呼叫的智能控制的一种网络。它是现有的移动网与智能网的结合。如果将移动网的交换中心改造为 SSP 业务交换点，使底层的移动网络与高层的智能网（SCP、SMP、SCE、SMAP 等）相连，从而将移动交换与业务分开实现，便形成了移动智能网。

借助于 No. 7 信令网和大型集中式数据库的支持，移动智能网将网络的交换功能与控制功能相分离，把电话网中原来位于各个端局交换机中的网络智能集中到新设的功能部件——由中小型计算机组成的智能网业务控制点上，而原有的交换机仅完成基本的接续功能。

移动智能网系统的总体结构如附图 1 所示，一般由业务交换点 18（SSP）、业务控制点 16（SCP）、智能外设 19（IP）、业务管理系统 13（SMS）、业务生成环境 11（SCE）等几部分组成。SSP 是连接现有移动网与智能网的连接点，提供接入智能网功能集的功能。SCP 是智能网的核心构件，它存储用户数据和业务逻辑。主要功能是接收 SSP 送来的查询信息并查询数据库，进行各种译码；同时，SCP 能根据 SSP 上报来的呼叫事件启动不同的业务逻辑，根据业务逻辑向相应的 SSP 发出呼叫控制指令，从而实现各种智能呼叫。IP 是协助完成智能业务的特殊资源。通常具有各种语音功能，如语音合成，播放录音通知，接收双音多频拨号，进行语音识别等等。SMS 由计算机系统组成，一般具备 5 种功能，即业务逻辑管理、业务数据管理、用户数据管理、业务监测以及业务量管理。SCE 的功能是根据客户的需求生成新的业务逻辑。

在目前的移动网中，用户使用手机呼叫还是双向计费，即手机用户不论呼叫或接听电话都要付费，这样就给用户带来一定的不便，例如离家在外地上学地学生，家长为沟通方

便为子女购买手机，但子女使用手机和家里通话后还需缴纳较高的电话费用，家里也不便为其缴纳费用；在公司业务中也有类似的问题，例如公司想向客户调查了解客户的意见或客户需要向公司反馈情况或投诉，在目前的计费政策下，客户需自己支付通话费用，而实际上公司是愿意为客户支付此通话费的。

而且此业务的开展也对移动运营商有好处，运营商的总收入会因此业务的开展刺激业务量，从而提供收入。

目前与本发明最类似的业务是固定电话的 800 被叫付费业务，此业务可在交换机上做数据，标识出被叫付费业务的话单，从而实现被叫付费，也可以在固定智能网上实现。但是，该现有技术具有以下缺点：

- 1、800 业务是针对集团用户的，而不是针对个人用户的。
- 2、800 业务只能使用固定电话拨打，不能使用移动电话拨打。
- 3、800 业务只能是被叫付费业务。
- 4、800 业务的资费政策不灵活。

发明内容

针对现有技术的以上缺点，本发明设计了一种在移动智能网上实现主被叫付费的业务。本发明的业务通过以下呼叫信令流程来实现：

- 1) 用户通过拨打被叫号码的方式或者通过拨打业务接入码加被叫号码的方式进行呼叫方；
- 2) 主叫方移动交换中心 (MSCa) 收到呼叫后通过一种触发方式触发业务，向主叫用户的业务控制点 (SCP) 发送初始事件上报 (IDP) 消息；
- 3) SCP 根据主叫位置和被叫号码确定主叫用户的费率并折算成通话时长，向 MSCa 发送配置 EDP (Event Detection Point) 事件 (RRBE)、下发计费信息 (AC) 和下发接续操作 (Connect)；
- 4) MSCa 收到 Connect 消息后向被叫用户的归属位置寄存器 (HLR) 发送获取用户漫游号码 (SRI) 消息，取得其相应于触发方式的信息和被叫位置信息 (Location Information)；
- 5) MSCa 向 SCP 发送 IDP 消息，并将 MSCa 所在位置的长途区号放在 IDP 消息中的 Location Number 参数中，将被叫位置信息 Location Information 放在 IDP 消息中的 Location Information 参数中；

- 6) SCP 收到 IDP 消息后分析被叫用户帐户,若帐户有效则 SCP 根据资费政策和从 IDP 得到的被叫位置信息 Location Information 确定被叫费率并折算成通话时长,向 MSCa 发送 RRBE、AC 和 connect;
- 7) MSCa 向被叫方 HLR 再次发送 SRI 消息,得到被叫的漫游号码 (MSRN);
- 8) MSCa 根据被叫的漫游号码 MSRN 进行接续;
- 9) 主、被叫任一方挂机, MSCa 向 SCP 上报计费报告 (ApplyCharging Report) 和挂机事件 (ERB);
- 10) SCP 下发释放呼叫 (ReleaseCall) 消息,结束呼叫。

其中,主叫方移动交换中心 (MSCa) 同时具有业务交换点 (SSP) 和用户拜访位置寄存器 (VLR) 的功能;被叫位置信息 (Location Information) 包含用户拜访位置寄存器信息 (Vlr-number)。

用户可根据自身的需要拨打某个业务接入码加被叫号码进行呼叫,此呼叫中被叫所需的费用记在主叫的帐户上,被叫免费接听;用户可拨打另外某个业务接入码加被叫号码进行呼叫,此呼叫中主叫所需的费用记在被叫的帐户上,主叫免费呼叫;用户也可拨打某个业务接入码加被叫号码进行呼叫,其资费部分记在主叫的帐户上,其余部分记在被叫的帐户上。

主被叫付费业务可利用智能网计费灵活、业务特征可灵活定制的特点方便地为全网个人、集团用户提供服务。

本发明的业务既可以采用接入码触发或者号段触发或者接入码加号段触发,也可以采用目标网签约信息触发。

采用接入码触发或者号段触发或者接入码加号段触发时, MSC 需根据接入码将呼叫路由至 SSP,在 SSP 上触发主被叫付费业务,而被叫流程的触发需 SCP 与 SSP 做特殊的指令配合才可。

在主叫流程中,采用目标网签约信息触发时,用户还需要拨打接入码,从 MSC 直接触发智能业务至 SCP,从而执行主被叫付费业务的业务逻辑。若主叫用户没有签约信息, MSC 可将呼叫路由至 SSP,在 SSP 上根据用户的号段信息或呼叫号码的前缀,在用户的“归属” SCP 上触发智能业务。

在被叫流程中,若用户有签约信息,还是根据签约信息触发被叫流程,若用户没有签约信息,则可在主叫流程中为被叫计费、出话单。

本发明还提供一系列管理功能,系统提供包括对用户表进行添加可接入号码、删除可

接入号码、允许全部接入、禁止全部接入的维护操作。

本发明成功地解决了现有技术所具有的缺点，其特点是：

- 1、本发明的客户群包含集团用户和个人用户；
- 2、本发明是针对移动用户的；
- 3、本发明既可实现主叫付费也可以实现被叫付费；
- 4、本发明可利用智能网计费灵活的特点实现灵活的资费政策，如在主叫付费业务中，可设置主叫只为被叫支付基本通话费或主被叫按一定比例分摊被叫应支付的费用。

附图说明

图1是移动智能网系统的总体结构图。

图2是主被叫流程图。

图3是业务管理流程图。

图4是呼叫信令流程图。

具体实施方式

下面结合附图和实施例来进一步介绍本发明。

本实施例以签约信息触发为例。

1. 呼叫信令流程

本实施例的呼叫信令流程如附图4所示。

- 1) 用户通过拨打被叫号码的方式或者通过拨打业务接入码加被叫号码的方式进行呼叫；
- 2) 主叫方移动交换中心(MSCa)收到呼叫后根据主叫的签约信息O_CSI触发业务，向主叫用户的业务控制点(SCP)发送初始事件上报(IDP)消息，并将MSCa所在位置的长途区号放在IDP消息中的位置号(Location Number)参数中；
- 3) SCP根据主叫位置和被叫号码确定主叫用户的费率并折算成通话时长，向MSCa发送配置EDP(Event Detection Point)事件(RRBE)、下发计费信息(AC)和下发接续操作(Connect)；
- 4) MSCa收到Connect消息后向被叫用户的归属位置寄存器(HLR)发送获取用户漫游号码(SRI)消息，若被叫是签约用户则返回签约信息O_CSI+T_CSI和被叫位置信息(Location Information)；
- 5) MSCa向SCP发送IDP消息，并将MSCa所在位置的长途区号放在IDP消息中的

Location Number 参数中, 将被叫位置信息 Location Information 放在 IDP 消息中的 Location Information 参数中;

- 6) SCP 收到 IDP 消息后分析被叫用户帐户, 若帐户有效则 SCP 根据资费政策和从 IDP 得到的被叫位置信息 Location Information 确定被叫费率并折算成通话时长, 向 MSCa 发送 RRBE、AC 和 connect;
- 7) MSCa 向被叫方 HLR 再次发送 SRI 消息, 此次 SRI 消息抑制 T-COI, 得到被叫的漫游号码 (MSRN);
- 8) MSCa 根据被叫的漫游号码 MSRN 进行接续, 包括 IAM, ACM, ANC 三个 ISUP 信令;
- 9) 主、被叫任一方挂机, MSCa 向 SCP 上报计费报告 (ApplyCharging Report) 和挂机事件 (ERB), 主叫挂机上报 DP9, 被叫挂机上报 DP17;
- 10) SCP 下发释放呼叫 (ReleaseCall) 消息, 结束呼叫。

2. 主被叫流程

如附图 2 所示, 本业务在接到呼叫时, 首先判断确认主叫号码和被叫号码是否都属于签约用户, 并对漫游出省的情况做出处理, 最后接收挂机信号后根据计费结果写出话单后释放呼叫, 结束处理。

其具体流程是:

- a. 用户拨被叫号码; 若该用户在用户表中检索到, 则执行步骤 b, 否则通知用户不能使用该业务, 执行步骤 h;
- b. 若被叫用户在用户表中检索到, 则执行步骤 c, 否则通知用户不能使用该业务, 执行步骤 h;
- c. 若被叫号码漫游出省, 则执行步骤 d, 否则执行步骤 e;
- d. 若允许被叫漫游出省, 则执行步骤 e, 否则通知用户不能使用该业务, 执行步骤 h;
- e. 设置呼叫费率处理;
- f. 双方通话, 结束时, 接收挂机信号;
- g. 根据计费结果写话单;
- h. 结束, 释放呼叫。

3. 业务管理流程

如附图 3 所示, 本业务可为用户提供一系列管理功能, 对用户表进行包括添加/删除用户, 允许/禁止全部接入的各种维护操作。

其具体流程为:

- a. 用户拨打业务管理用号码；若主叫号码在用户表中检索到，则执行步骤 b，否则通知用户不能使用该业务，执行步骤 g；
- b. 系统给出语音提示，用户选择业务菜单：添加可接入号码，删除可接入号码，允许（禁止）全部接入，查询，挂机退出；若用户选择添加可接入号码则执行步骤 c1，若用户选择删除可接入号码则执行步骤 d1，若用户选择允许（禁止）全部接入则执行步骤 e1，若用户选择查询则执行步骤 f1，若用户选择挂机退出则执行步骤 g；
- c1. 系统给出语音提示，请用户输入要添加的手机号码；
- c2. 用户输入号码；如号码正确，则执行步骤 c3，否则给出输入号码错误的语音提示，执行步骤 c2；
- c3. 系统给出语音提示，请用户确认，若用户选择确认则执行步骤 c4 否则执行步骤 c2；
- c4. 若用户输入的号码能使用此业务，则执行步骤 c5，否则系统给出语音提示，说明该手机号码不能使用该项业务，执行步骤 c6；
- c5. 执行操作，如操作成功，系统给出语音提示添加/删除号码操作成功；否则给出添加/删除号码操作失败的语音提示；
- c6. 执行步骤 b；
- d1. 系统给出语音提示，请用户输入要删除的手机号码；
- d2. 用户输入号码；如号码正确，则执行步骤 d3，否则系统给出输入号码错误的语音提示，执行步骤 d2；
- d3. 系统给出语音提示，请用户确认，若用户选择确认则执行步骤 d4，否则执行步骤 d2；
- d4. 执行操作，如操作成功，系统给出语音提示添加/删除号码操作成功；否则给出添加/删除号码操作失败的语音提示；
- d5. 执行步骤 b；
- e1. 如系统当前为禁止全部接入执行步骤 e2，否则执行步骤 e4；
- e2. 执行允许全部接入操作，如成功系统给出语音提示可接入号码已全部开放；否则给出操作不成功的语音提示；
- e3. 执行步骤 g；
- e4. 执行禁止全部接入操作，如成功系统给出语音提示可接入号码已全部禁止；否则给出操作不成功的语音提示；
- e5. 执行步骤 e3；

- f1. 系统给出语音提示所有可供接入的权限号码的信息;
- f2. 执行步骤 b;
- g. 结束。



图1



图2

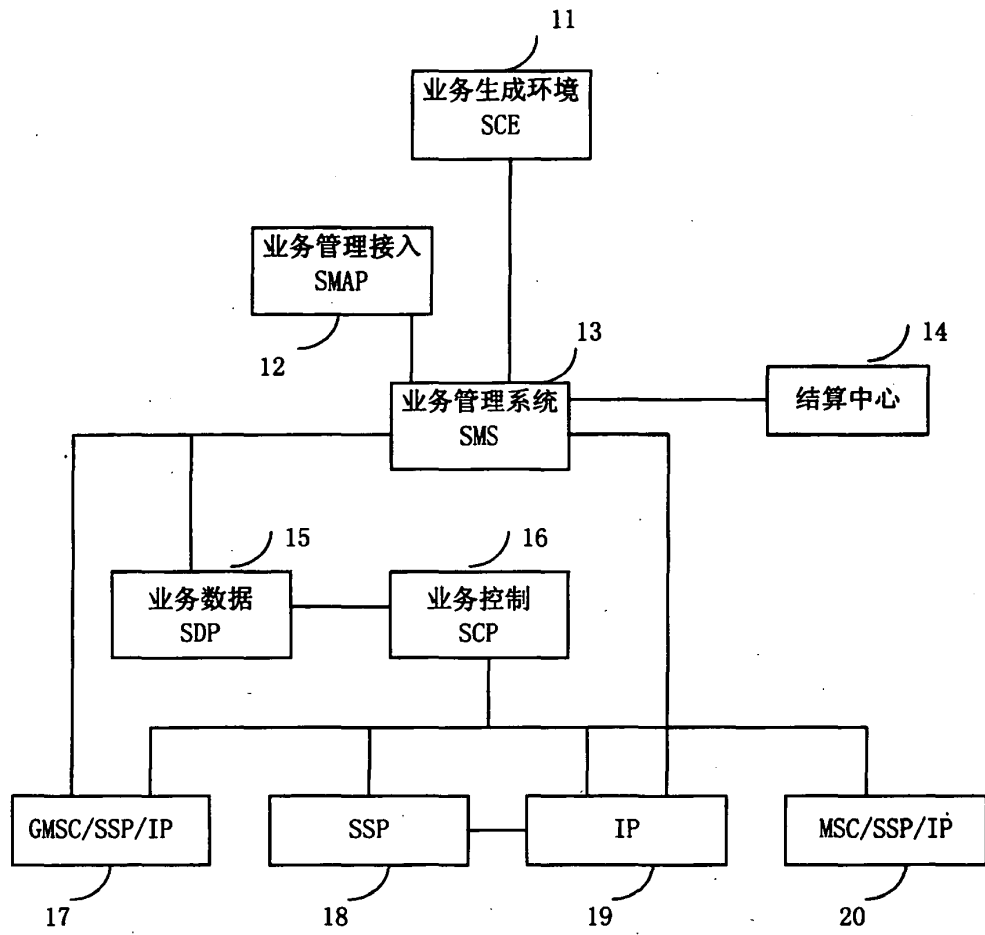

图3

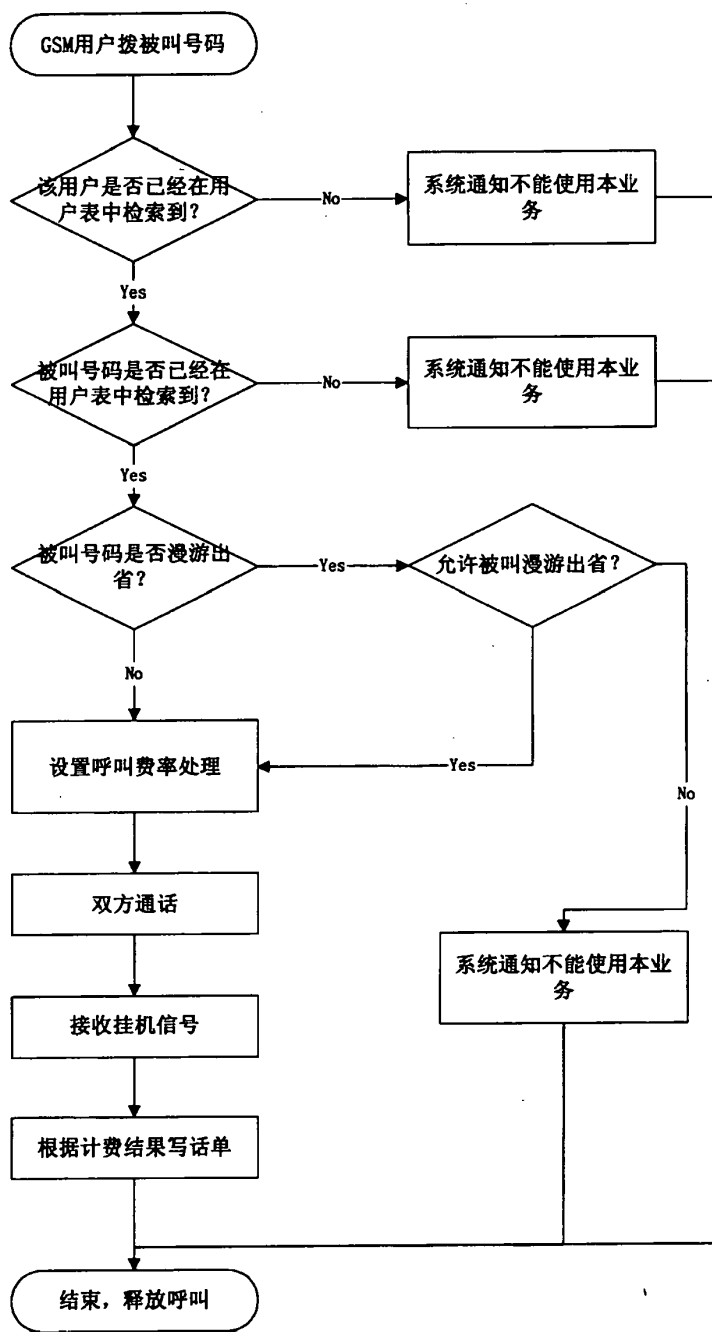

图4

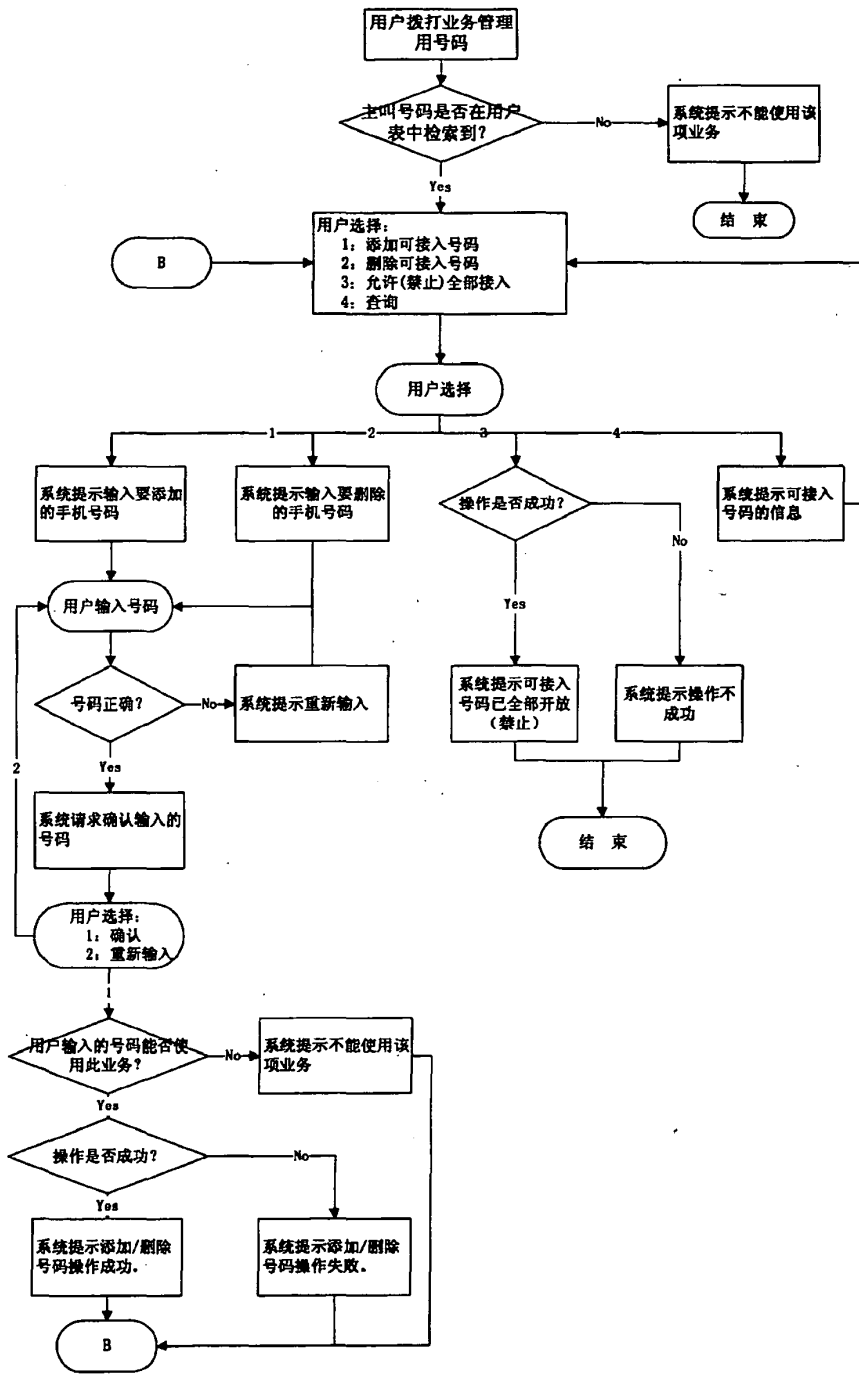

[Handwritten signature]

PATENT
Attorney Docket No. 11005.0219-00000
Huawei Ref. No.: 0410606US

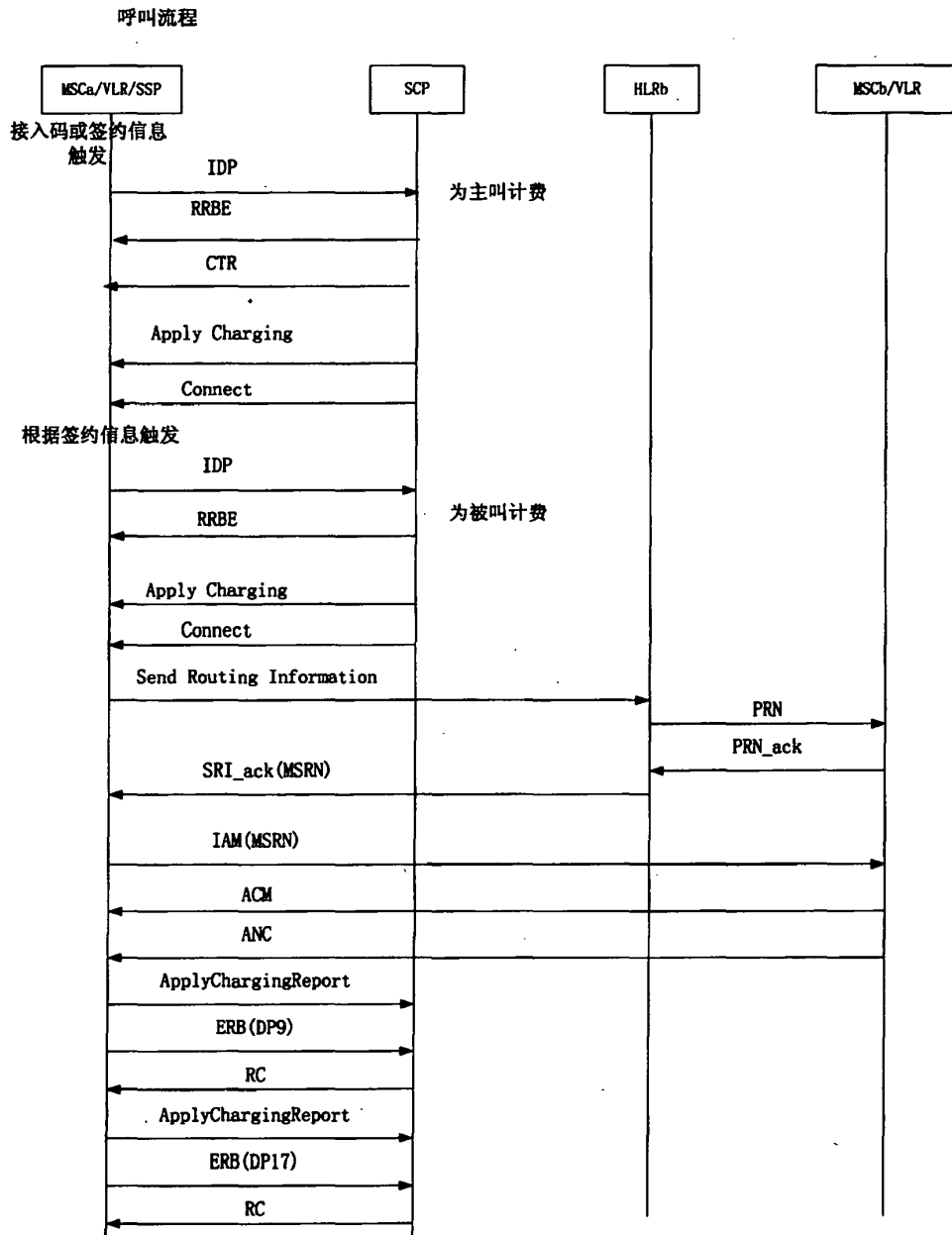
IN THE UNITED STATES PATENT AND TRADEMARK OFFICE

In re Application of:)	
Xiaoqin Duan)	Group Art Unit: 2614
Application No.: 11/502,921)	Examiner: Tieu, Binh Kien
Filed: August 11, 2006)	
For: METHOD FOR CONTROLLING)	Confirmation No.: 9151
CHARGING OF PACKET DATA)	
SERVICE)	

Commissioner for Patents
P.O. Box 1450
Alexandria, VA 22313-1450

Sir:

INFORMATION DISCLOSURE STATEMENT UNDER 37 C.F.R. § 1.97(c)

Pursuant to 37 C.F.R. §§ 1.56 and 1.97(c), Applicants bring to the attention of the Examiner the documents on the attached listing. This Information Disclosure Statement is being filed after the events recited in Section 1.97(b) but, to the undersigned's knowledge, before the mailing date of either a Final action, Quayle action, or a Notice of Allowance. Under the provisions of 37 C.F.R. § 1.97(c), this Information Disclosure Statement is accompanied by a fee of \$180.00 as specified by Section 1.17(p).

Copies of the listed foreign and non-patent literature documents are attached.

Copies of the U.S. patents and published applications are not enclosed.

02/26/2010 JADD01 00000004 11502921
01 FC:1306 180.00 DP

Applicants respectfully request that the Examiner consider the listed documents and indicate that they were considered by making appropriate notations on the attached form.

This submission does not represent that a search has been made or that no better art exists and does not constitute an admission that each or all of the listed documents are material or constitute "prior art." If the Examiner applies any of the documents as prior art against any claim in the application and Applicants determine that the cited documents do not constitute "prior art" under United States law, Applicants reserve the right to present to the office the relevant facts and law regarding the appropriate status of such documents.

Applicants further reserve the right to take appropriate action to establish the patentability of the disclosed invention over the listed documents, should one or more of the documents be applied against the claims of the present application.

If there is any fee due in connection with the filing of this Statement, please charge the fee to our Deposit Account No. 06-0916.

Respectfully submitted,

FINNEGAN, HENDERSON, FARABOW,
GARRETT & DUNNER, L.L.P.

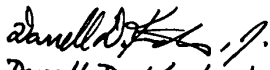
Darrell D. Kinder, Jr.

Dated: February 24, 2010

By: Reg. No. 57,460
Weiguo Chen
for Reg. No. 61,878
(650) 849-6600



UNITED STATES PATENT AND TRADEMARK OFFICE

UNITED STATES DEPARTMENT OF COMMERCE
United States Patent and Trademark Office
Address: COMMISSIONER FOR PATENTS
P.O. Box 1450
Alexandria, Virginia 22313-1450
www.uspto.gov

APPLICATION NUMBER	FILING OR 371(C) DATE	FIRST NAMED APPLICANT	ATTY. DOCKET NO./TITLE
11/502,921	08/11/2006	Xiaoqin Duan	30952/42236

CONFIRMATION NO. 9151

POA ACCEPTANCE LETTER

22852
FINNEGAN, HENDERSON, FARABOW, GARRETT & DUNNER
LLP
901 NEW YORK AVENUE, NW
WASHINGTON, DC 20001-4413



Date Mailed: 02/12/2010

NOTICE OF ACCEPTANCE OF POWER OF ATTORNEY

This is in response to the Power of Attorney filed 01/12/2010.

The Power of Attorney in this application is accepted. Correspondence in this application will be mailed to the above address as provided by 37 CFR 1.33.

/mjgordon/

Office of Data Management, Application Assistance Unit (571) 272-4000, or (571) 272-4200, or 1-888-786-0101



UNITED STATES PATENT AND TRADEMARK OFFICE

UNITED STATES DEPARTMENT OF COMMERCE
United States Patent and Trademark Office
Address: COMMISSIONER FOR PATENTS
P.O. Box 1450
Alexandria, Virginia 22313-1450
www.uspto.gov

APPLICATION NUMBER	FILING OR 371(C) DATE	FIRST NAMED APPLICANT	ATTY. DOCKET NO./TITLE
11/502,921	08/11/2006	Xiaoqin Duan	30952/42236

CONFIRMATION NO. 9151

POWER OF ATTORNEY NOTICE

4743
MARSHALL, GERSTEIN & BORUN LLP
233 SOUTH WACKER DRIVE
6300 SEARS TOWER
CHICAGO, IL 60606-6357



Date Mailed: 02/12/2010

NOTICE REGARDING CHANGE OF POWER OF ATTORNEY

This is in response to the Power of Attorney filed 01/12/2010.

- The Power of Attorney to you in this application has been revoked by the assignee who has intervned as provided by 37 CFR 3.71. Future correspondence will be mailed to the new address of record(37 CFR 1.33).

/mjgordon/

Office of Data Management, Application Assistance Unit (571) 272-4000, or (571) 272-4200, or 1-888-786-0101



UNITED STATES PATENT AND TRADEMARK OFFICE

UNITED STATES DEPARTMENT OF COMMERCE
United States Patent and Trademark Office
Address: COMMISSIONER FOR PATENTS
P.O. Box 1450
Alexandria, Virginia 22313-1450
www.uspto.gov

APPLICATION NO.	FILING DATE	FIRST NAMED INVENTOR	ATTORNEY DOCKET NO.	CONFIRMATION NO.
-----------------	-------------	----------------------	---------------------	------------------

11/502,921	08/11/2006	Xiaoqin Duan	30952/42236	9151
------------	------------	--------------	-------------	------

4743 7590 01/28/2010
 MARSHALL, GERSTEIN & BORUN LLP
 233 SOUTH WACKER DRIVE
 6300 SEARS TOWER
 CHICAGO, IL 60606-6357

EXAMINER

TIEU, BINH KIEN

ART UNIT	PAPER NUMBER
----------	--------------

2614

MAIL DATE	DELIVERY MODE
-----------	---------------

01/28/2010	PAPER
------------	-------

Please find below and/or attached an Office communication concerning this application or proceeding.

The time period for reply, if any, is set in the attached communication.

Interview Summary	Application No. 11/502,921	Applicant(s) DUAN, XIAOQIN	
	Examiner BINH K. TIEU	Art Unit 2614	

All participants (applicant, applicant's representative, PTO personnel):

(1) BINH K. TIEU. (3)_____.

(2) Applicant/s Rep. Mr. Vivian Hsu (Req.65,418). (4)_____.

Date of Interview: 25 January 2010.

Type: a) Telephonic b) Video Conference
c) Personal [copy given to: 1) applicant 2) applicant's representative]

Exhibit shown or demonstration conducted: d) Yes e) No.
If Yes, brief description: _____.

Claim(s) discussed: 1-16.

Identification of prior art discussed: Ricagni (Pub No.: US 2004/0255025).

Agreement with respect to the claims f) was reached. g) was not reached. h) N/A.

Substance of Interview including description of the general nature of what was agreed to if an agreement was reached, or any other comments: Discussed about the amendment filed on 01/12/2010. Discussed about the application server read on "CRF." Discussed about the Applicant's arguments stated on page 7 of his/her remarks. Examiner explained to the Applicant's Rep. that such arguments are not clearly stated in claim 1. Examiner suggested the Applicant's Rep to clarify the CRF in order to distinguish from teaching of the application server in the reference.

(A fuller description, if necessary, and a copy of the amendments which the examiner agreed would render the claims allowable, if available, must be attached. Also, where no copy of the amendments that would render the claims allowable is available, a summary thereof must be attached.)

THE FORMAL WRITTEN REPLY TO THE LAST OFFICE ACTION MUST INCLUDE THE SUBSTANCE OF THE INTERVIEW. (See MPEP Section 713.04). If a reply to the last Office action has already been filed, APPLICANT IS GIVEN A NON-EXTENDABLE PERIOD OF THE LONGER OF ONE MONTH OR THIRTY DAYS FROM THIS INTERVIEW DATE, OR THE MAILING DATE OF THIS INTERVIEW SUMMARY FORM, WHICHEVER IS LATER, TO FILE A STATEMENT OF THE SUBSTANCE OF THE INTERVIEW. See Summary of Record of Interview requirements on reverse side or on attached sheet.

/BINH K. TIEU/ Primary Examiner, Art Unit 2614	
---	--

Summary of Record of Interview Requirements

Manual of Patent Examining Procedure (MPEP), Section 713.04, Substance of Interview Must be Made of Record

A complete written statement as to the substance of any face-to-face, video conference, or telephone interview with regard to an application must be made of record in the application whether or not an agreement with the examiner was reached at the interview.

Title 37 Code of Federal Regulations (CFR) § 1.133 Interviews Paragraph (b)

In every instance where reconsideration is requested in view of an interview with an examiner, a complete written statement of the reasons presented at the interview as warranting favorable action must be filed by the applicant. An interview does not remove the necessity for reply to Office action as specified in §§ 1.111, 1.135. (35 U.S.C. 132)

37 CFR §1.2 Business to be transacted in writing.

All business with the Patent or Trademark Office should be transacted in writing. The personal attendance of applicants or their attorneys or agents at the Patent and Trademark Office is unnecessary. The action of the Patent and Trademark Office will be based exclusively on the written record in the Office. No attention will be paid to any alleged oral promise, stipulation, or understanding in relation to which there is disagreement or doubt.

The action of the Patent and Trademark Office cannot be based exclusively on the written record in the Office if that record is itself incomplete through the failure to record the substance of interviews.

It is the responsibility of the applicant or the attorney or agent to make the substance of an interview of record in the application file, unless the examiner indicates he or she will do so. It is the examiner's responsibility to see that such a record is made and to correct material inaccuracies which bear directly on the question of patentability.

Examiners must complete an Interview Summary Form for each interview held where a matter of substance has been discussed during the interview by checking the appropriate boxes and filling in the blanks. Discussions regarding only procedural matters, directed solely to restriction requirements for which interview recordation is otherwise provided for in Section 812.01 of the Manual of Patent Examining Procedure, or pointing out typographical errors or unreadable script in Office actions or the like, are excluded from the interview recordation procedures below. Where the substance of an interview is completely recorded in an Examiners Amendment, no separate Interview Summary Record is required.

The Interview Summary Form shall be given an appropriate Paper No., placed in the right hand portion of the file, and listed on the "Contents" section of the file wrapper. In a personal interview, a duplicate of the Form is given to the applicant (or attorney or agent) at the conclusion of the interview. In the case of a telephone or video-conference interview, the copy is mailed to the applicant's correspondence address either with or prior to the next official communication. If additional correspondence from the examiner is not likely before an allowance or if other circumstances dictate, the Form should be mailed promptly after the interview rather than with the next official communication.

The Form provides for recordation of the following information:

- Application Number (Series Code and Serial Number)
- Name of applicant
- Name of examiner
- Date of interview
- Type of interview (telephonic, video-conference, or personal)
- Name of participant(s) (applicant, attorney or agent, examiner, other PTO personnel, etc.)
- An indication whether or not an exhibit was shown or a demonstration conducted
- An identification of the specific prior art discussed
- An indication whether an agreement was reached and if so, a description of the general nature of the agreement (may be by attachment of a copy of amendments or claims agreed as being allowable). Note: Agreement as to allowability is tentative and does not restrict further action by the examiner to the contrary.
- The signature of the examiner who conducted the interview (if Form is not an attachment to a signed Office action)

It is desirable that the examiner orally remind the applicant of his or her obligation to record the substance of the interview of each case. It should be noted, however, that the Interview Summary Form will not normally be considered a complete and proper recordation of the interview unless it includes, or is supplemented by the applicant or the examiner to include, all of the applicable items required below concerning the substance of the interview.

A complete and proper recordation of the substance of any interview should include at least the following applicable items:

- 1) A brief description of the nature of any exhibit shown or any demonstration conducted,
- 2) an identification of the claims discussed,
- 3) an identification of the specific prior art discussed,
- 4) an identification of the principal proposed amendments of a substantive nature discussed, unless these are already described on the Interview Summary Form completed by the Examiner,
- 5) a brief identification of the general thrust of the principal arguments presented to the examiner,
(The identification of arguments need not be lengthy or elaborate. A verbatim or highly detailed description of the arguments is not required. The identification of the arguments is sufficient if the general nature or thrust of the principal arguments made to the examiner can be understood in the context of the application file. Of course, the applicant may desire to emphasize and fully describe those arguments which he or she feels were or might be persuasive to the examiner.)
- 6) a general indication of any other pertinent matters discussed, and
- 7) if appropriate, the general results or outcome of the interview unless already described in the Interview Summary Form completed by the examiner.

Examiners are expected to carefully review the applicant's record of the substance of an interview. If the record is not complete and accurate, the examiner will give the applicant an extendable one month time period to correct the record.

Examiner to Check for Accuracy

If the claims are allowable for other reasons of record, the examiner should send a letter setting forth the examiner's version of the statement attributed to him or her. If the record is complete and accurate, the examiner should place the indication, "Interview Record OK" on the paper recording the substance of the interview along with the date and the examiner's initials.

Under the Paperwork Reduction Act of 1995, no persons are required to respond to a collection of information unless it displays a valid OMB control number.

STATEMENT UNDER 37 CFR 3.73(b)

Applicant/Patent Owner: Huawei Technologies Co., Ltd.

Application No./Patent No.: 11/502,921 Filed/Issue Date: August 11, 2006

Titled: Method for Controlling Charging of Packet Data Service

Huawei Technologies Co., Ltd., a Corporation
(Name of Assignee) (Type of Assignee, e.g., corporation, partnership, university, government agency, etc.)

states that it is:

- 1. the assignee of the entire right, title, and interest in;
- 2. an assignee of less than the entire right, title, and interest in
(The extent (by percentage) of its ownership interest is _____ %); or
- 3. the assignee of an undivided interest in the entirety of (a complete assignment from one of the joint inventors was made)

the patent application/patent identified above, by virtue of either:

A. An assignment from the inventor(s) of the patent application/patent identified above. The assignment was recorded in the United States Patent and Trademark Office at Reel 018458, Frame 0674, or for which a copy therefore is attached.

OR

B. A chain of title from the inventor(s), of the patent application/patent identified above, to the current assignee as follows:

1. From: _____ To: _____

The document was recorded in the United States Patent and Trademark Office at
Reel _____, Frame _____, or for which a copy thereof is attached.

2. From: _____ To: _____

The document was recorded in the United States Patent and Trademark Office at
Reel _____, Frame _____, or for which a copy thereof is attached.

3. From: _____ To: _____

The document was recorded in the United States Patent and Trademark Office at
Reel _____, Frame _____, or for which a copy thereof is attached.

Additional documents in the chain of title are listed on a supplemental sheet(s).

As required by 37 CFR 3.73(b)(1)(i), the documentary evidence of the chain of title from the original owner to the assignee was, or concurrently is being, submitted for recordation pursuant to 37 CFR 3.11.

[NOTE: A separate copy (i.e., a true copy of the original assignment document(s)) must be submitted to Assignment Division in accordance with 37 CFR Part 3, to record the assignment in the records of the USPTO. See MPEP 302.06]

The undersigned (whose title is supplied below) is authorized to act on behalf of the assignee.

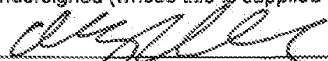
Signature

January 12, 2010
Date

Weiguo Chen
Printed or Typed Name

Attorney; Reg. No.: 61,878
Title

This collection of information is required by 37 CFR 3.73(b). The information is required to obtain or retain a benefit by the public which is to file (and by the USPTO to process) an application. Confidentiality is governed by 35 U.S.C. 122 and 37 CFR 1.11 and 1.14. This collection is estimated to take 12 minutes to complete, including gathering, preparing, and submitting the completed application form to the USPTO. Time will vary depending upon the individual case. Any comments on the amount of time you require to complete this form and/or suggestions for reducing this burden, should be sent to the Chief Information Officer, U.S. Patent and Trademark Office, U.S. Department of Commerce, P.O. Box 1450, Alexandria, VA 22313-1450. DO NOT SEND FEES OR COMPLETED FORMS TO THIS ADDRESS. SEND TO: Commissioner for Patents, P.O. Box 1450, Alexandria, VA 22313-1450.

If you need assistance in completing the form, call 1-800-PTO-9199 and select option 2.

Under the Paperwork Reduction Act of 1995, no persons are required to respond to a collection of information unless it displays a valid OMB control number.

POWER OF ATTORNEY TO PROSECUTE APPLICATIONS BEFORE THE USPTO

I hereby revoke all previous powers of attorney given in the application identified in the attached statement under 37 CFR 3.73(b).

I hereby appoint:

Practitioners associated with the Customer Number: 22852

OR

Practitioner(s) named below (if more than ten patent practitioners are to be named, then a customer number must be used):

Name	Registration Number	Name	Registration Number

as attorney(s) or agent(s) to represent the undersigned before the United States Patent and Trademark Office (USPTO) in connection with any and all patent applications assigned only to the undersigned according to the USPTO assignment records or assignment documents attached to this form in accordance with 37 CFR 3.73(b).

Please change the correspondence address for the application identified in the attached statement under 37 CFR 3.73(b) to:

The address associated with Customer Number: 22852

OR

<input type="checkbox"/> Firm or Individual Name			
Address			
City	State	Zip	
Country			
Telephone			Email

Assignee Name and Address:

Huawei Technologies Co., Ltd.
 Building B1-3-A, Huawei Industrial Base, Bantian
 Longgang District, Shenzhen, P.R. China 518129

A copy of this form, together with a statement under 37 CFR 3.73(b) (Form PTO/BB/90 or equivalent) is required to be filed in each application in which this form is used. The statement under 37 CFR 3.73(b) may be completed by one of the practitioners appointed in this form if the appointed practitioner is authorized to act on behalf of the assignee, and must identify the application in which this Power of Attorney is to be filed.

SIGNATURE of Assignee of Record

The individual whose signature and title is supplied below is authorized to act on behalf of the assignee

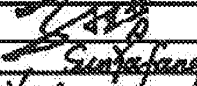
Signature		Date	8th October 2011
Name	Sunfang	Telephone	+86-755-2876700
Title	Director		

This collection of information is required by 37 CFR 1.31, 1.32 and 1.33. The information is required to obtain or retain a benefit by the public which is to file (and by the USPTO to process) an application. Confidentiality is governed by 38 U.S.C. 122 and 37 CFR 1.11 and 1.14. This collection is estimated to take 3 minutes to complete, including gathering, preparing, and submitting the completed application form to the USPTO. Time will vary depending upon the individual case. Any comments on the amount of time you require to complete this form and/or suggestions for reducing this burden, should be sent to the Chief Information Officer, U.S. Patent and Trademark Office, U.S. Department of Commerce, P.O. Box 1480, Alexandria, VA 22313-1480. DO NOT SEND FEES OR COMPLETED FORMS TO THIS ADDRESS. SEND TO: Commissioner for Patents, P.O. Box 1480, Alexandria, VA 22313-1480.

If you need assistance in completing the form, call 1-800-PTO-9198 and select option 2.

Electronic Acknowledgement Receipt

EFS ID:	6797851
Application Number:	11502921
International Application Number:	
Confirmation Number:	9151
Title of Invention:	Method for controlling charging of packet data service
First Named Inventor/Applicant Name:	Xiaoqin Duan
Customer Number:	04743
Filer:	Weiguo Chen/Nicole Walsh
Filer Authorized By:	Weiguo Chen
Attorney Docket Number:	30952/42236
Receipt Date:	12-JAN-2010
Filing Date:	11-AUG-2006
Time Stamp:	19:22:41
Application Type:	Utility under 35 USC 111(a)

Payment information:

Submitted with Payment	no
------------------------	----

File Listing:

Document Number	Document Description	File Name	File Size(Bytes)/ Message Digest	Multi Part /.zip	Pages (if appl.)
1		0410606USStatementUnder37 3andPOA110050219.pdf	152340 <small>34b381835e2108b20c66a7e766dc0eabb9 32040d</small>	yes	2

Multipart Description/PDF files in .zip description		
Document Description	Start	End
Miscellaneous Incoming Letter	1	1
Power of Attorney	2	2
Warnings:		
Information:		
Total Files Size (in bytes):		152340
<p>This Acknowledgement Receipt evidences receipt on the noted date by the USPTO of the indicated documents, characterized by the applicant, and including page counts, where applicable. It serves as evidence of receipt similar to a Post Card, as described in MPEP 503.</p> <p><u>New Applications Under 35 U.S.C. 111</u> If a new application is being filed and the application includes the necessary components for a filing date (see 37 CFR 1.53(b)-(d) and MPEP 506), a Filing Receipt (37 CFR 1.54) will be issued in due course and the date shown on this Acknowledgement Receipt will establish the filing date of the application.</p> <p><u>National Stage of an International Application under 35 U.S.C. 371</u> If a timely submission to enter the national stage of an international application is compliant with the conditions of 35 U.S.C. 371 and other applicable requirements a Form PCT/DO/EO/903 indicating acceptance of the application as a national stage submission under 35 U.S.C. 371 will be issued in addition to the Filing Receipt, in due course.</p> <p><u>New International Application Filed with the USPTO as a Receiving Office</u> If a new international application is being filed and the international application includes the necessary components for an international filing date (see PCT Article 11 and MPEP 1810), a Notification of the International Application Number and of the International Filing Date (Form PCT/RO/105) will be issued in due course, subject to prescriptions concerning national security, and the date shown on this Acknowledgement Receipt will establish the international filing date of the application.</p>		

PATENT
Customer No. 22,852
NEW ATTORNEY DOCKET NO.: 11005.0219
Huawei Ref. No.: 0410606US

IN THE UNITED STATES PATENT AND TRADEMARK OFFICE

In re Application of:)
)
Xiaoqin Duan) Group Art Unit: 2614
)
Application No.: 11/502,921) Examiner: Tieu, Binh Kien
)
Filed: August 11, 2006) Confirmation No.: 9151
)
For: METHOD FOR CONTROLLING)
CHARGING OF PACKET DATA)
SERVICE)

COMMISSIONER FOR PATENTS

P.O. Box 1450
Alexandria, VA 22313-1450

AMENDMENT

Sir:

In response to the Office Action mailed November 12, 2009, with a period for response extending through February 12, 2010, Applicant amends the above-identified U.S. patent application as follows:

Amendments to the Claims are reflected in the listing of claims which begins on page 2 of this paper.

Remarks/Arguments begin on page 6 of this paper.

REMARKS

In the Office Action,¹ the Examiner rejected claims 1-6 under 35 U.S.C. § 102(b) as being anticipated by Ricagni (U.S. Patent Publication No. 2004/0255025) ("Ricagni").

Applicant amends claims 1-6 to improve form and clarity. Support for the claim amendments may be found in Applicant's specification at, e.g., para. [0065] and [0066]. Applicant also adds new claims 7-17. Support for new claims 7-17 may be found in Applicant's specification at, e.g., para. [0064] - [0077] and Figure 6. Upon entry of this Amendment, claims 1-17 remain pending. Applicant respectfully traverses the rejection for at least the following reasons.

Rejection of Claims 1-6 under 35 U.S.C. § 102(b)

Applicant traverses the rejection of claims 1-6 under 35 U.S.C. § 102(b) as being anticipated by Ricagni. Ricagni does not anticipate these claims.

In order to properly establish anticipation under 35 U.S.C. § 102, the Federal Circuit has held that "[a] claim is anticipated only if each and every element as set forth in the claim is found, either expressly or inherently described, in a single prior art reference." *Verdegaal Bros. v. Union Oil Co. of California*, 814 F.2d 628, 631, 2 USPQ2d 1051, 1053 (Fed. Cir. 1987). Furthermore, "[t]he identical invention must be shown in as complete detail as is contained in the ... claim." *Richardson v. Suzuki Motor Co.*, 868 F.2d 1126, 1236, 9 U.S.P.Q.2d 1913, 1920 (Fed. Cir. 1989). *See also* M.P.E.P. § 2131.

Ricagni fails to teach or suggest each and every element recited in the claims. For example, Ricagni fails to teach or suggest at least "[a] method for controlling the charging of

¹ The Office Action may contain statements characterizing the related art, case law, and claims. Regardless of whether any such statements are specifically identified herein, Applicant declines to automatically subscribe to any statements in the Office Action.

packet data service, comprising: monitoring, by a Traffic Plane Function (TPF), an event trigger provided by a Charging Rule Function (CRF); and sending, by the TPF, a charging rule request to the CRF, if the event trigger is met,” as recited in independent claim 1 (emphasis added).

The Examiner alleged that “Ricagni teaches ... monitoring a plurality of event triggers (para. [0085]) [and] triggers being set by a network operator in para. [0072] and [0098]” (Office Action, p. 2). However, Ricagni does not teach or suggest “monitoring ... an event trigger provided by a Charging Rule Function (CRF),” as recited in claim 1 (emphasis added).

Ricagni discloses that “[t]he gateway (8) is set up by the network operator to associate a particular trigger with service flows to the application server (12) based on the service flow matching triggering criteria [box B in FIG. 3a]. ... The TPF (8) then sends a message [Box E in FIG. 3a] to the event owner containing” (para. [0072]-[0100], emphasis added). Ricagni further discloses “the network operator [is] generally a business organization” (para. [0007]). However, neither the portion of Ricagni cited by the Examiner nor any other portion of Ricagni teaches “[a] method for controlling the charging of packet data service, comprising: monitoring, by a Traffic Plane Function (TPF), an event trigger provided by a Charging Rule Function (CRF); and sending, by the TPF, a charging rule request to the CRF, if the event trigger is met,” as recited in independent claim 1 (emphasis added).

For at least the above reasons, Ricagni fails to teach or suggest each and every element recited in claim 1 and, hence, does not anticipate claim 1. Claim 1 is allowable. The 35 U.S.C. § 102(b) rejection of claim 1 and, hence, dependent claims 2-6, is therefore improper and should be withdrawn.

New Claims 7-17

Claim 7 depends from base claim 1. As discussed above, claim 1 includes allowable subject matter. Claim 7 is also allowable at least by virtue of its dependence from base claim 1.

Independent claims 8 and 14, although different in scope from claim 1 and from each other, recite elements similar to those as discussed with respect to claim 1 and are thus allowable for at least the reasons discussed above with respect to claim 1. Dependent claims 9-13 and 15-17 are also allowable at least by virtue of their dependence from one of base claims 8 and 14.

Conclusion

In view of the foregoing, Applicant requests reconsideration of the application and withdrawal of the rejection. Pending claims 1-17 are in condition for allowance. Accordingly, Applicant requests a favorable action.

If there are any remaining issues or misunderstandings, Applicant requests the Examiner telephone the undersigned representative to discuss them.

Please grant any extensions of time required to enter this response and charge any additional required fees to our deposit account 06-0916.

Respectfully submitted,

FINNEGAN, HENDERSON, FARABOW,
GARRETT & DUNNER, L.L.P.

Dated: January 12, 2010

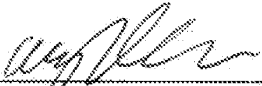
By: 
Weiguo (Will) Chen
Reg. No. 61,878

Electronic Acknowledgement Receipt

EFS ID:	6797875
Application Number:	11502921
International Application Number:	
Confirmation Number:	9151
Title of Invention:	Method for controlling charging of packet data service
First Named Inventor/Applicant Name:	Xiaoqin Duan
Customer Number:	04743
Filer:	Weiguo Chen/Nicole Walsh
Filer Authorized By:	Weiguo Chen
Attorney Docket Number:	30952/42236
Receipt Date:	12-JAN-2010
Filing Date:	11-AUG-2006
Time Stamp:	19:26:15
Application Type:	Utility under 35 USC 111(a)

Payment information:

Submitted with Payment	no
------------------------	----

File Listing:

Document Number	Document Description	File Name	File Size(Bytes)/ Message Digest	Multi Part /.zip	Pages (if appl.)
1	Amendment/Req. Reconsideration-After Non-Final Reject	0410606USAmendment110050 219.pdf	159453 f7eed2d6a3c1e4339213f8735b4b27e1714 2c018	no	8

Warnings:

Information:

Total Files Size (in bytes):

159453

This Acknowledgement Receipt evidences receipt on the noted date by the USPTO of the indicated documents, characterized by the applicant, and including page counts, where applicable. It serves as evidence of receipt similar to a Post Card, as described in MPEP 503.

New Applications Under 35 U.S.C. 111

If a new application is being filed and the application includes the necessary components for a filing date (see 37 CFR 1.53(b)-(d) and MPEP 506), a Filing Receipt (37 CFR 1.54) will be issued in due course and the date shown on this Acknowledgement Receipt will establish the filing date of the application.

National Stage of an International Application under 35 U.S.C. 371

If a timely submission to enter the national stage of an international application is compliant with the conditions of 35 U.S.C. 371 and other applicable requirements a Form PCT/DO/EO/903 indicating acceptance of the application as a national stage submission under 35 U.S.C. 371 will be issued in addition to the Filing Receipt, in due course.

New International Application Filed with the USPTO as a Receiving Office

If a new international application is being filed and the international application includes the necessary components for an international filing date (see PCT Article 11 and MPEP 1810), a Notification of the International Application Number and of the International Filing Date (Form PCT/RO/105) will be issued in due course, subject to prescriptions concerning national security, and the date shown on this Acknowledgement Receipt will establish the international filing date of the application.

AMENDMENTS TO THE CLAIMS

Please amend the claims, as indicated below. This listing of claims will replace all prior versions, and listings, of claims in the application.

Listing of Claims:

1. (Currently amended) A method for controlling the charging of packet data service, comprising ~~the steps of:~~
~~monitoring, by a Traffic Plane Function (TPF), a plurality of an event triggers trigger~~
~~provided by a Charging Rule Function (CRF); and~~
~~sending, by the TPF, a charging rule request from a Traffic Plane Function (TPF) to the~~
~~CRF, a Charging Rule Function (CRF), when one of said if the event trigger is met.~~

2. (Currently amended) The method according to Claim 1, wherein said ~~the event triggers~~
~~are trigger~~ is set by the CRF, and ~~includes a bearer modification event then provided to the TPF.~~

3. (Currently amended) The method according to Claim 2, ~~further comprising:~~
~~storing, by the TPF, the event trigger provided by the CRF.~~
~~wherein the TPF stores said event triggers received from the CRF and monitors if any of~~
~~said event triggers is met.~~

4. (Currently amended) The method according to Claim 1, wherein said ~~the charging rule~~
~~request sending sent~~ from the TPF to the CRF ~~when one of said event trigger is met selectively~~
~~comprises an event identifier indicating the event trigger which indicates a corresponding trigger~~
~~event.~~

5. (Currently amended) The method according to Claim 4, wherein the CRF ~~responses for~~ said responds to the charging rule request by providing a charging rule in a charging rule provision procedure according to the trigger event trigger.

6. (Currently amended) The method according to Claim 2, wherein ~~said the event triggers~~ trigger and a provision charging rule are provided by the CRF to the TPF, and the provision charging rule is set by the CRF are set according to relevant self-stored information stored in the CRF, or charging-relevant input information provided by the TPF, the charging-relevant input information including at least one of information related with a subscriber and a UE, bearer characteristics information, and network information, an Application Function (AF), an Online Charging System (OCS), the TPF, or combinations of the AF, the OCS, and the TPF.

7. (New) The method according to Claim 1, wherein the event trigger is set by the CRF, and includes at least one of a change of a Serving GPRS Support Node (SGSN), a change of a Public Land Mobile Network (PLMN), a change of a Radio Access Technology (RAT) type, a change of a Traffic Flow Template (TFT), and a change of Quality of Service (QoS).

8. (New) A Traffic Plane Function (TPF) for controlling charging of packet data service, comprising:

a monitoring unit, configured to monitor an event trigger provided by a Charging Rule Function (CRF); and

a sending unit, configured to send a charging rule request to the CRF if the event trigger is met.

9. (New) The TPF according to claim 8, wherein the event trigger includes a bearer modification event.

10. (New) The TPF according to claim 9, wherein the bearer modification event comprises at least one of a change of a Serving GPRS Support Node (SGSN), a change of a Public Land Mobile Network (PLMN), a change of a Radio Access Technology (RAT) type, a change of a Traffic Flow Template (TFT), and a change of Quality of Service (QoS).

11. (New) The TPF according to Claim 10, further comprising a unit configured to store the event trigger provided by the CRF.

12. (New) The TPF according to Claim 8, wherein the charging rule request sent from the TPF to the CRF comprises an event identifier indicating the event trigger.

13. (New) The TPF according to Claim 12, wherein the CRF responds to the charging rule request by providing a charging rule in a charging rule provision procedure according to the event trigger.

14. (New) A Charging Rule Function (CRF) for controlling charging of packet data service, comprising:

a determining unit, configured to determine an event trigger; and
a providing unit, configured to provide the event trigger to a Traffic Plane Function (TPF).

15. (New) The CRF according to claim 14, wherein the event trigger and a provision charging rule are provided by the CRF to the TPF, and the provision charging rule is set by the CRF according to relevant information stored in the CRF, or charging-relevant input information provided by the TPF, the charging-relevant input information including at least one of information related with a subscriber and a UE, bearer characteristics information, and network information.

16. (New) The CRF according to claim 14, wherein the event trigger includes a bearer modification event.

17. (New) The CRF according to claim 16, wherein the bearer modification event comprises at least one of a change of a Serving GPRS Support Node (SGSN), a change of a Public Land Mobile Network (PLMN), a change of a Radio Access Technology (RAT) type, a change of a Traffic Flow Template (TFT), and a change of Quality of Service (QoS).

Under the Paperwork Reduction Act of 1995, no persons are required to respond to a collection of information unless it displays a valid OMB control number.

PATENT APPLICATION FEE DETERMINATION RECORD Substitute for Form PTO-875					Application or Docket Number 11/502,921		Filing Date 08/11/2006		<input type="checkbox"/> To be Mailed	
APPLICATION AS FILED – PART I										
(Column 1)			(Column 2)		SMALL ENTITY <input type="checkbox"/>			OR		OTHER THAN SMALL ENTITY
FOR		NUMBER FILED	NUMBER EXTRA		RATE (\$)	FEE (\$)	OR		RATE (\$)	FEE (\$)
<input type="checkbox"/> BASIC FEE <small>(37 CFR 1.16(a), (b), or (c))</small>		N/A	N/A		N/A				N/A	
<input type="checkbox"/> SEARCH FEE <small>(37 CFR 1.16(k), (l), or (m))</small>		N/A	N/A		N/A		N/A			
<input type="checkbox"/> EXAMINATION FEE <small>(37 CFR 1.16(o), (p), or (q))</small>		N/A	N/A		N/A		N/A			
TOTAL CLAIMS <small>(37 CFR 1.16(i))</small>		minus 20 =	*		X \$ =		X \$ =			
INDEPENDENT CLAIMS <small>(37 CFR 1.16(h))</small>		minus 3 =	*		X \$ =		X \$ =			
<input type="checkbox"/> APPLICATION SIZE FEE <small>(37 CFR 1.16(s))</small>		If the specification and drawings exceed 100 sheets of paper, the application size fee due is \$250 (\$125 for small entity) for each additional 50 sheets or fraction thereof. See 35 U.S.C. 41(a)(1)(G) and 37 CFR 1.16(s).								
<input type="checkbox"/> MULTIPLE DEPENDENT CLAIM PRESENT <small>(37 CFR 1.16(j))</small>										
* If the difference in column 1 is less than zero, enter "0" in column 2.										
APPLICATION AS AMENDED – PART II										
(Column 1)			(Column 2)		SMALL ENTITY			OR		OTHER THAN SMALL ENTITY
AMENDMENT	01/12/2010	CLAIMS REMAINING AFTER AMENDMENT		HIGHEST NUMBER PREVIOUSLY PAID FOR	PRESENT EXTRA	RATE (\$)	ADDITIONAL FEE (\$)		RATE (\$)	ADDITIONAL FEE (\$)
	Total <small>(37 CFR 1.16(o))</small>	* 17	Minus	** 20	= 0	X \$ =		OR	X \$2=	0
	Independent <small>(37 CFR 1.16(h))</small>	* 2	Minus	***3	= 0	X \$ =		OR	X \$220=	0
	<input type="checkbox"/> Application Size Fee <small>(37 CFR 1.16(s))</small>									
	<input type="checkbox"/> FIRST PRESENTATION OF MULTIPLE DEPENDENT CLAIM <small>(37 CFR 1.16(j))</small>									
						TOTAL ADD'L FEE		OR	TOTAL ADD'L FEE	0
AMENDMENT		CLAIMS REMAINING AFTER AMENDMENT		HIGHEST NUMBER PREVIOUSLY PAID FOR	PRESENT EXTRA	RATE (\$)	ADDITIONAL FEE (\$)		RATE (\$)	ADDITIONAL FEE (\$)
	Total <small>(37 CFR 1.16(o))</small>	*	Minus	**	=	X \$ =		OR	X \$ =	
	Independent <small>(37 CFR 1.16(h))</small>	*	Minus	***	=	X \$ =		OR	X \$ =	
	<input type="checkbox"/> Application Size Fee <small>(37 CFR 1.16(s))</small>									
	<input type="checkbox"/> FIRST PRESENTATION OF MULTIPLE DEPENDENT CLAIM <small>(37 CFR 1.16(j))</small>									
						TOTAL ADD'L FEE		OR	TOTAL ADD'L FEE	
* If the entry in column 1 is less than the entry in column 2, write "0" in column 3.										
** If the "Highest Number Previously Paid For" IN THIS SPACE is less than 20, enter "20".										
*** If the "Highest Number Previously Paid For" IN THIS SPACE is less than 3, enter "3".										
The "Highest Number Previously Paid For" (Total or Independent) is the highest number found in the appropriate box in column 1.										
						Legal Instrument Examiner: /MARCIA J. GORDON/				

This collection of information is required by 37 CFR 1.16. The information is required to obtain or retain a benefit by the public which is to file (and by the USPTO to process) an application. Confidentiality is governed by 35 U.S.C. 122 and 37 CFR 1.14. This collection is estimated to take 12 minutes to complete, including gathering, preparing, and submitting the completed application form to the USPTO. Time will vary depending upon the individual case. Any comments on the amount of time you require to complete this form and/or suggestions for reducing this burden, should be sent to the Chief Information Officer, U.S. Patent and Trademark Office, U.S. Department of Commerce, P.O. Box 1450, Alexandria, VA 22313-1450. DO NOT SEND FEES OR COMPLETED FORMS TO THIS ADDRESS. **SEND TO: Commissioner for Patents, P.O. Box 1450, Alexandria, VA 22313-1450.**

If you need assistance in completing the form, call 1-800-PTO-9199 and select option 2.



UNITED STATES PATENT AND TRADEMARK OFFICE

UNITED STATES DEPARTMENT OF COMMERCE
United States Patent and Trademark Office
Address: COMMISSIONER FOR PATENTS
P.O. Box 1450
Alexandria, Virginia 22313-1450
www.uspto.gov

APPLICATION NO.	FILING DATE	FIRST NAMED INVENTOR	ATTORNEY DOCKET NO.	CONFIRMATION NO.
11/502,921	08/11/2006	Xiaoqin Duan	30952/42236	9151
4743 7590 11/12/2009 MARSHALL, GERSTEIN & BORUN LLP 233 SOUTH WACKER DRIVE 6300 SEARS TOWER CHICAGO, IL 60606-6357			EXAMINER	
			TIEU, BINH KIEN	
			ART UNIT	PAPER NUMBER
			2614	
			MAIL DATE	DELIVERY MODE
			11/12/2009	PAPER

Please find below and/or attached an Office communication concerning this application or proceeding.

The time period for reply, if any, is set in the attached communication.

Office Action Summary	Application No. 11/502,921	Applicant(s) DUAN, XIAOQIN	
	Examiner BINH K. TIEU	Art Unit 2614	

-- The MAILING DATE of this communication appears on the cover sheet with the correspondence address --
Period for Reply

A SHORTENED STATUTORY PERIOD FOR REPLY IS SET TO EXPIRE 3 MONTH(S) OR THIRTY (30) DAYS, WHICHEVER IS LONGER, FROM THE MAILING DATE OF THIS COMMUNICATION.

- Extensions of time may be available under the provisions of 37 CFR 1.136(a). In no event, however, may a reply be timely filed after SIX (6) MONTHS from the mailing date of this communication.
- If NO period for reply is specified above, the maximum statutory period will apply and will expire SIX (6) MONTHS from the mailing date of this communication.
- Failure to reply within the set or extended period for reply will, by statute, cause the application to become ABANDONED (35 U.S.C. § 133). Any reply received by the Office later than three months after the mailing date of this communication, even if timely filed, may reduce any earned patent term adjustment. See 37 CFR 1.704(b).

Status

- 1) Responsive to communication(s) filed on 11 August 2006.
- 2a) This action is **FINAL**. 2b) This action is non-final.
- 3) Since this application is in condition for allowance except for formal matters, prosecution as to the merits is closed in accordance with the practice under *Ex parte Quayle*, 1935 C.D. 11, 453 O.G. 213.

Disposition of Claims

- 4) Claim(s) 1-6 is/are pending in the application.
 - 4a) Of the above claim(s) _____ is/are withdrawn from consideration.
- 5) Claim(s) _____ is/are allowed.
- 6) Claim(s) 1-6 is/are rejected.
- 7) Claim(s) _____ is/are objected to.
- 8) Claim(s) _____ are subject to restriction and/or election requirement.

Application Papers

- 9) The specification is objected to by the Examiner.
- 10) The drawing(s) filed on _____ is/are: a) accepted or b) objected to by the Examiner.
 Applicant may not request that any objection to the drawing(s) be held in abeyance. See 37 CFR 1.85(a).
 Replacement drawing sheet(s) including the correction is required if the drawing(s) is objected to. See 37 CFR 1.121(d).
- 11) The oath or declaration is objected to by the Examiner. Note the attached Office Action or form PTO-152.

Priority under 35 U.S.C. § 119

- 12) Acknowledgment is made of a claim for foreign priority under 35 U.S.C. § 119(a)-(d) or (f).
 - a) All b) Some * c) None of:
 - 1. Certified copies of the priority documents have been received.
 - 2. Certified copies of the priority documents have been received in Application No. _____.
 - 3. Copies of the certified copies of the priority documents have been received in this National Stage application from the International Bureau (PCT Rule 17.2(a)).
- * See the attached detailed Office action for a list of the certified copies not received.

Attachment(s)

- 1) Notice of References Cited (PTO-892)
- 2) Notice of Draftsperson's Patent Drawing Review (PTO-948)
- 3) Information Disclosure Statement(s) (PTO/SB/08)
 Paper No(s)/Mail Date 3/12/07&3/16/07&5/29/07&8/20/09.
- 4) Interview Summary (PTO-413)
 Paper No(s)/Mail Date. _____.
- 5) Notice of Informal Patent Application
- 6) Other: _____.

DETAILED ACTION

Claim Rejections - 35 USC § 102

1. The following is a quotation of the appropriate paragraphs of 35 U.S.C. 102 that form the basis for the rejections under this section made in this Office action:

A person shall be entitled to a patent unless –

(b) the invention was patented or described in a printed publication in this or a foreign country or in public use or on sale in this country, more than one year prior to the date of application for patent in the United States.

2. Claims 1-6 are rejected under 35 U.S.C. 102(b) as being anticipated by Ricagni (Pub. No.: US 2004/0255025).

Regarding claim 1, Ricagni teaches a method for controlling the charging of packet data service, comprising the steps of:

monitoring a plurality of event triggers (para. [0085]); and

sending a charging rule request from a Traffic Plane Function (TPF) to a Charging Rule Function (CRF), when one of said event trigger is met (i.e., TPF (8) sends a message (read on charging rule request) to event owner (14) as shown in para. [0100]-[0105], and the event owner (14) replies to the TPF (8) with an event result specified a cost code as shown in examples 2 and 4 in TABLE ONE, see para. [0106], [0109], [0111] and [0113]).

Regarding claim 2, note triggers being set by a network operator in para. [0072] and [0098].

Regarding claim 3, note monitoring all service flows that match to trigger criteria set up at the TPF (8) in para. [0100]-[0098].

Regarding claim 4, note an identification of a set of service flow characteristic to be sent to the event owner (14) in para. [0092] and/or the information on the set of events that are reported to the event owner (14) in para. [0103].

Regarding claim 5, note the event result being sent back to the TPF (8) wherein the event results comprised a cost code as shown in Table One, para. [0111], [0106] and [0109].

Regarding claim 6, note examples in para. [0112]-[0116].

Conclusion

3. The prior art made of record and not relied upon is considered pertinent to applicant's disclosure.

Roberts (Pub. No.: US 2004/0125755) teaches in a packet communications network, combined billing of a user is provided for the delivery of communications services to that user and for the on-line purchase of goods and services by the user via the communication service. A set of rules is provided and a respective billing tariff and account is determined from the rules and each packet address.

4. Any inquiry concerning this communication or earlier communications from the examiner should be directed to Binh K. Tieu whose telephone number is (571) 272-7510 and E-mail address: BINH.TIEU@USPTO.GOV.

If attempts to reach the examiner by telephone are unsuccessful, the examiner's supervisor, Mr. Curtis Kuntz, can be reached on (571) 272-7499 and **IF PAPER HAS BEEN MISSED FROM THIS OFFICIAL ACTION PACKAGE, PLEASE CALL CUSTOMER SERVICE FOR THE SUBSTITUTIONS OR COPIES.**

Application/Control Number: 11/502,921

Page 4

Art Unit: 2614

Any response to this action should be mailed to:
Commissioner of Patents and Trademarks
Washington, D.C. 20231
Or faxed to: (571) 273-8300
Hand Carry Deliveries to:
Customer Service Window
(Randolph Building)
401 Dulany Street
Alexandria, VA 22314

Information regarding the status of an application may be obtained from the Patent Application Information Retrieval (PAIR) system. Status information for published applications may be obtained from either Private PAIR or Public PAIR. Status information for unpublished applications is available through Private PAIR only. For more information about the FAIR system, see <http://pair-direct.uspto.gov>. If you have any questions on access to the Private PAIR system, contact the Electronic Business Center (EBC) at 866-217-9197 (toll-free).

/BINH K. TIEU/
Primary Examiner
Technology Division 2614

Date: November 2009

Notice of References Cited	Application/Control No. 11/502,921	Applicant(s)/Patent Under Reexamination DUAN, XIAOQIN	
	Examiner BINH K. TIEU	Art Unit 2614	Page 1 of 1

U.S. PATENT DOCUMENTS

*	Document Number Country Code-Number-Kind Code	Date MM-YYYY	Name	Classification
*	A US-2004/0125755	07-2004	Roberts, Timothy	370/259
*	B US-2004/0255025	12-2004	Ricagni, Giuseppe	709/224
	C US-			
	D US-			
	E US-			
	F US-			
	G US-			
	H US-			
	I US-			
	J US-			
	K US-			
	L US-			
	M US-			

FOREIGN PATENT DOCUMENTS

*	Document Number Country Code-Number-Kind Code	Date MM-YYYY	Country	Name	Classification
	N				
	O				
	P				
	Q				
	R				
	S				
	T				

NON-PATENT DOCUMENTS

*	Include as applicable: Author, Title Date, Publisher, Edition or Volume, Pertinent Pages)
U	
V	
W	
X	

*A copy of this reference is not being furnished with this Office action. (See MPEP § 707.05(a).)
Dates in MM-YYYY format are publication dates. Classifications may be US or foreign.



UNITED STATES PATENT AND TRADEMARK OFFICE

UNITED STATES DEPARTMENT OF COMMERCE
 United States Patent and Trademark Office
 Address: COMMISSIONER FOR PATENTS
 P.O. Box 1450
 Alexandria, Virginia 22313-1450
 www.uspto.gov

BIB DATA SHEET

CONFIRMATION NO. 9151

SERIAL NUMBER	FILING or 371(c) DATE RULE	CLASS	GROUP ART UNIT	ATTORNEY DOCKET NO.		
11/502,921	08/11/2006	370	2614	30952/42236		
APPLICANTS Xiaoqin Duan, Shenzhen, CHINA;						
** CONTINUING DATA ***** This application is a CON of PCT/CN05/00388 03/28/2005						
** FOREIGN APPLICATIONS ***** CHINA 200410030955.8 04/01/2004 CHINA 200410033721.9 04/09/2004						
** IF REQUIRED, FOREIGN FILING LICENSE GRANTED ** 08/29/2006						
Foreign Priority claimed <input checked="" type="checkbox"/> Yes <input type="checkbox"/> No 35 USC 119(a-d) conditions met <input checked="" type="checkbox"/> Yes <input type="checkbox"/> No Verified and Acknowledged <u>/BINH KIEN TIEU/</u> Examiner's Signature		<input type="checkbox"/> Met after Allowance <u>/BKT/</u> Initials	STATE OR COUNTRY CHINA	SHEETS DRAWINGS 6	TOTAL CLAIMS 6	INDEPENDENT CLAIMS 1
ADDRESS MARSHALL, GERSTEIN & BORUN LLP 233 SOUTH WACKER DRIVE 6300 SEARS TOWER CHICAGO, IL 60606-6357 UNITED STATES						
TITLE Method for controlling charging of packet data service						
FILING FEE RECEIVED 1130	FEES: Authority has been given in Paper No. _____ to charge/credit DEPOSIT ACCOUNT No. _____ for following:			<input type="checkbox"/> All Fees <input type="checkbox"/> 1.16 Fees (Filing) <input type="checkbox"/> 1.17 Fees (Processing Ext. of time) <input type="checkbox"/> 1.18 Fees (Issue) <input type="checkbox"/> Other _____ <input type="checkbox"/> Credit		



11502921 - GAU: 2614
[Signature]

PATENT
30952/42236

**IN THE UNITED STATES PATENT
AND TRADEMARK OFFICE**

Applicant: Duan)
Serial No.: 11/502,921)
Filed: August 11, 2006)
For: METHOD FOR)
CONTROLLING CHARGING OF)
PACKET DATA SERVICE)
Group Art Unit: 2616)
Examiner: To be assigned)

I hereby certify that this paper is being deposited with the United States Postal Service, first class postage prepaid, addressed to: MS Amendment, Commissioner for Patents, P.O. Box 1450, Alexandria, VA 22313-1450 on

March 6, 2007

[Signature]

James P. Zeller
Registration No. 28,491

INFORMATION DISCLOSURE STATEMENT

MS Amendment
Commissioner for Patents
P.O. Box 1450
Alexandria, VA 22313-1450

Sir:

The patents listed on the enclosed Form PTO-1449 are identified pursuant to 37 CFR §§1.56, 1.97, and 1.98. Copies of the patents are enclosed as required.

Entry and consideration of the submitted documents are solicited.

Respectfully submitted,

MARSHALL, GERSTEIN & BORUN LLP

March 6, 2007

By:

[Signature]

James P. Zeller, Registration No. 28,491
Attorney for Applicants
Customer No. 04743
6300 Sears Tower
233 South Wacker Drive
Chicago, Illinois 60606
312-474-6300



Sheet 1 of 1

Form PTO-449 (Mod. 03)	U.S. Department of Commerce Patent and Trademark Office	Atty. Docket No. 30952/42236	Serial No. 11/502,921
INFORMATION DISCLOSURE STATEMENT		Applicant Duan	
		Filing Date August 11, 2006	Group 2616 2614

U.S. PATENT DOCUMENTS							
*Examiner Initials	Document Number	Issue Date	Name	Class	Subclass	Filing Date if Appropriate	
/BKT/	2003/152039	08-14-2003	Roberts				

FOREIGN PATENT DOCUMENTS							
*Examiner Initials	Document Number	Publication Date	Country	Class	Subclass	Translation	
						Yes	No
/BKT/	WO-0139483	05-31-2001	PCT				
/BKT/	WO-0167706	09-13-2001	PCT				
/BKT/	WO-0191446	11-29-2001	PCT				

OTHER DOCUMENTS (Including Author, Title, Date, Pertinent Pages, etc.)	
/BKT/	International Search Report for PCT/CN2005/000388, mailed June 9, 2005.
/BKT/	Written Opinion for PCT/CN2005/000388, mailed June 9, 2005.

Examiner	/BINH TIEU/	Date Considered	11/04/2009
*EXAMINER: Initial if reference considered, whether or not citation is in conformance with MPEP 609; Draw line through citation if not in conformance and not considered. Include copy of this form with next communication to applicant.			

<i>Index of Claims</i> 	Application/Control No. 11502921	Applicant(s)/Patent Under Reexamination DUAN, XIAOQIN
	Examiner BINH K TIEU	Art Unit 2614

✓	Rejected	-	Cancelled	N	Non-Elected	A	Appeal
=	Allowed	÷	Restricted	I	Interference	O	Objected

<input type="checkbox"/> Claims renumbered in the same order as presented by applicant		<input type="checkbox"/> CPA		<input type="checkbox"/> T.D.		<input type="checkbox"/> R.1.47			
CLAIM		DATE							
Final	Original	11/04/2009							
	1	✓							
	2	✓							
	3	✓							
	4	✓							
	5	✓							
	6	✓							

Search Notes 	Application/Control No. 11502921	Applicant(s)/Patent Under Reexamination DUAN, XIAOQIN
	Examiner BINH K TIEU	Art Unit 2614

SEARCHED			
Class	Subclass	Date	Examiner
379	111, 114.01, 114.03, 114.05, 114.12, 115.01, 121.01, 124	11/05/2009	BKT
370	356-360, 401	11/05/2009	BKT

SEARCH NOTES		
Search Notes	Date	Examiner
WEST DATABASES TERMS SEARCHES	11/05/2009	BKT

INTERFERENCE SEARCH			
Class	Subclass	Date	Examiner

--	--



11502921 / 164 AU: 2614

I hereby certify that this paper (along with any paper referred to as being attached
(enclosed) is being deposited with the U.S. Postal Service on the date shown
below with sufficient postage as First Class Mail, in an envelope addressed to:
MS Amendment, Commissioner for Patents, P.O. Box 1450, Alexandria, VA
22313-1450.
Dated: March 13, 2007 Signature: [Signature]
(James P. Zeller)

Docket No.: 30952/42236
(PATENT)

IN THE UNITED STATES PATENT AND TRADEMARK OFFICE

In re Patent Application of:

Xiaoqin DUAN

Application No.: 11/502,921

Confirmation No.: 9151

Filed: August 11, 2006

Art Unit: 2616

For: METHOD FOR CONTROLLING
CHARGING OF PACKET DATA SERVICE

Examiner: Not Yet Assigned

**SUPPLEMENTAL
INFORMATION DISCLOSURE STATEMENT (IDS)**

MS Amendment
Commissioner for Patents
P.O. Box 1450
Alexandria, VA 22313-1450

Dear Sir:

The attached documents were cited in an Supplemental Search Report issued by the European Patent Office in counterpart European Patent Application No. 738259.0-1525 on February 22, 2007. Copies of the patents are enclosed as required.

Entry and consideration of the submitted documents are solicited.

Respectfully submitted,

MARSHALL, GERSTEIN & BORUN LLP
6300 Sears Tower
233 South Wacker Drive
Chicago, Illinois 60606
312-474-6300

By: [Signature]
James P. Zeller, Registration No. 28,491
Attorney for Applicant

March 13, 2007

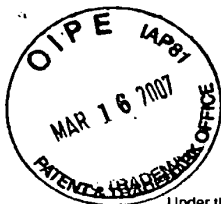

11502921 - GAU: 2614

PTO/SB/08A/B (09-06)

Approved for use through 03/31/2007. OMB 0651-0031
U.S. Patent and Trademark Office; U.S. DEPARTMENT OF COMMERCE

Under the Paperwork Reduction Act of 1995, no persons are required to respond to a collection of information unless it contains a valid OMB control number.

Substitute for form 1449/PTO		Complete if Known	
INFORMATION DISCLOSURE STATEMENT BY APPLICANT (Use as many sheets as necessary)		Application Number	11/502,921-Conf. #9151
		Filing Date	August 11, 2006
		First Named Inventor	Xiaoqin Duan
		Art Unit	2616
		Examiner Name	Not Yet Assigned
		Attorney Docket Number	30952/42236
Sheet	1	of	1

U.S. PATENT DOCUMENTS					
Examiner Initials*	Cite No. ¹	Document Number	Publication Date MM-DD-YYYY	Name of Patentee or Applicant of Cited Document	Pages, Columns, Lines, Where Relevant Passages or Relevant Figures Appear
		Number-Kind Code ² (if known)			
/BKT/	A*	US-2003/014367	01-16-2003	Tubinis	
/BKT/	B*	US-2002/152319 A1	10-17-2002	Amin	

FOREIGN PATENT DOCUMENTS						
Examiner Initials*	Cite No. ¹	Foreign Patent Document	Publication Date MM-DD-YYYY	Name of Patentee or Applicant of Cited Document	Pages, Columns, Lines, Where Relevant Passages or Relevant Figures Appear	T ⁶
		Country Code ³ -Number ⁴ -Kind Code ⁵ (if known)				
/BKT/	C	WO-WO 2004/036890 A1	04-29-2004	Lialiamou et al.		✓
/BKT/	D	WO-WO 01/91446 A2	11-29-2001	Nokia Corp.		✓

*EXAMINER: Initial if reference considered, whether or not citation is in conformance with MPEP 609. Draw line through citation if not in conformance and not considered. Include copy of this form with next communication to applicant. *CITE NO.: Those application(s) which are marked with a single asterisk (*) next to the Cite No. are not supplied (under 37 CFR 1.98(a)(2)(iii)) because that application was filed after June 30, 2003 or is available in the IFW. ¹ Applicant's unique citation designation number (optional). ² See Kinds Codes of USPTO Patent Documents at www.uspto.gov or MPEP 901.04. ³ Enter Office that issued the document, by the two-letter code (WIPO Standard ST.3). ⁴ For Japanese patent documents, the indication of the year of the reign of the Emperor must precede the serial number of the patent document. ⁵ Kind of document by the appropriate symbols as indicated on the document under WIPO Standard ST.16 if possible. ⁶ Applicant is to place a check mark here if English language Translation is attached.

NON PATENT LITERATURE DOCUMENTS			
Examiner Initials	Cite No. ¹	Include name of the author (in CAPITAL LETTERS), title of the article (when appropriate), title of the item (book, magazine, journal, serial, symposium, catalog, etc.), date, page(s), volume-issue number(s), publisher, city and/or country where published.	T ²
/BKT/	E	ETSI: "Universal Mobile Telecommunications System (UMTS); Telecommunications Management; Charging and Billing; 3G Call And Even Data For The Packet Switched (PS) Domain (3GPP TS 32.015 version 3.12.0 Release 1999) ETSI TS 132 015 V3.12.0 (2003-12) 31 December 2003 (2003-12-31) Pages 1-66.	
/BKT/	F	"3rd Generation Partnership Project," March 2004 (2004-03), 3GPP TS 23.125 V6.0.0, XX, Page(s) 1-29.	
/BKT/	G	Communication and Supplemental European Search Report corresponding to European Patent Application Serial No. EP 05738259.0-1525, European Patent Office, dated February 22, 2007, 5 pages.	

*EXAMINER: Initial if reference considered, whether or not citation is in conformance with MPEP 609. Draw line through citation if not in conformance and not considered. Include copy of this form with next communication to applicant.

¹ Applicant's unique citation designation number (optional). ² Applicant is to place a check mark here if English language Translation is attached.

Examiner Signature	/BINH TIEU/	Date Considered	11/04/2009
--------------------	-------------	-----------------	------------



PATENT
30952/42236

**IN THE UNITED STATES PATENT
AND TRADEMARK OFFICE**

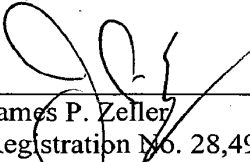
Applicant: Duan)	I hereby certify that this paper is being
)	deposited with the United States Postal
Serial No.: 11/502,921)	Service, first class postage prepaid, addressed
)	to: MS Amendment, Commissioner for
Filed: August 11, 2006)	Patents, P.O. Box 1450, Alexandria, VA
)	22313-1450 on
For: METHOD FOR)	
CONTROLLING CHARGING OF)	May 24, 2007
PACKET DATA SERVICE)	
)	
Group Art Unit: 2616)	
)	James P. Zeller
Examiner: To be assigned)	Registration No. 28,491

SUPPLEMENTAL INFORMATION DISCLOSURE STATEMENT

MS Amendment
Commissioner for Patents
P.O. Box 1450
Alexandria, VA 22313-1450

Sir:

The document listed on the enclosed Form PTO-1449 is identified pursuant to 37 CFR §§1.56, 1.97, and 1.98. A copy of the document is enclosed as required.

Entry and consideration of the submitted documents are solicited.

Respectfully submitted,

MARSHALL, GERSTEIN & BORUN LLP

May 24, 2007

By:

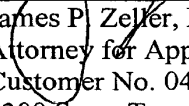

 James P. Zeller, Registration No. 28,491
 Attorney for Applicants
 Customer No. 04743
 6300 Sears Tower
 233 South Wacker Drive
 Chicago, Illinois 60606
 312-474-6300



Form PTO-1449 (Modified)	U.S. Department of Commerce Patent and Trademark Office	Atty. Docket No. 30952/42236	Serial No. 11/502,921
SUPPLEMENTAL INFORMATION DISCLOSURE STATEMENT		Applicant Duan	
		Filing Date August 11, 2006	Group 2616

U.S. PATENT DOCUMENTS							
*Examiner Initials	Document Number	Issue Date	Name	Class	Subclass	Filing Date if Appropriate	

FOREIGN PATENT DOCUMENTS							
*Examiner Initials	Document Number	Publication Date	Country	Class	Subclass	Translation	
						Yes	No

OTHER DOCUMENTS (Including Author, Title, Date, Pertinent Pages, etc.)	
/BKT/	European Office Action for European Application No. 05738259.0, dated May 11, 2007.

Examiner /BINH TIEU/	Date Considered 11/04/2009
*EXAMINER: Initial if reference considered, whether or not citation is in conformance with MPEP 609; Draw line through citation if not in conformance and not considered. Include copy of this form with next communication to applicant.	



11502921 - GAU: 2614

Sheet 1 of 1

Form PTO-1449 (Modified)	U.S. Department of Commerce Patent and Trademark Office	Atty. Docket No. 30952/42236	Serial No. 11/502,921
SECOND SUPPLEMENTAL INFORMATION DISCLOSURE STATEMENT		Applicant Xiaoqin Duan	
		Filing Date March 28, 2005	Group 2616

U.S. PATENT DOCUMENTS							
*Examiner Initials	Document Number	Issue Date	Name	Class	Subclass	Filing Date if Appropriate	
/BKT/	2003/153333	08-14-2003	Shirai et al.	455	466		

FOREIGN PATENT DOCUMENTS							
*Examiner Initials	Document Number	Publication Date	Country	Class	Subclass	Translation	
						Yes	No
/BKT/	2003-152778	05-23-2003	JP			Abstract Only	
/BKT/	WO-02/093835	11-21-2002	PCT			Abstract Only	

OTHER DOCUMENTS (Including Author, Title, Date, Pertinent Pages, etc.)	
/BKT/	English-language translation of Official Action for correspondence Japanese Application No. 2007-503178, dated July 14, 2009.

Examiner	/BINH TIEU/	Date Considered	11/04/2009
*EXAMINER: Initial if reference considered, whether or not citation is in conformance with MPEP 609; Draw line through citation if not in conformance and not considered. Include copy of this form with next communication to applicant.			

WEST Search History for Application 11502921

Creation Date: 2009110413:15

Prior Art Searches

Query	DB	Op.	Plur.	Thes.	Date
PDP context	PGPB, USPT, USOC, EPAB, JPAB, DWPI, TDBD	ADJ	YES		10-29-2009
different with charg\$3	PGPB, USPT, USOC, EPAB, JPAB, DWPI, TDBD	ADJ	YES		10-29-2009
(different with charg\$3) and (PDP context)	PGPB, USPT, USOC, EPAB, JPAB, DWPI, TDBD	ADJ	YES		10-29-2009
WAP with browse	PGPB, USPT, USOC, EPAB, JPAB, DWPI, TDBD	ADJ	YES		10-29-2009
packet data with data service	PGPB, USPT, USOC, EPAB, JPAB, DWPI, TDBD	ADJ	YES		10-29-2009
packet with data service	PGPB, USPT, USOC, EPAB, JPAB, DWPI, TDBD	ADJ	YES		10-29-2009
(packet with data service) and (different with charg\$3 and PDP context)	PGPB, USPT, USOC, EPAB, JPAB, DWPI, TDBD	ADJ	YES		10-29-2009
bear or transmission channel	PGPB, USPT, USOC, EPAB, JPAB, DWPI, TDBD	ADJ	YES		10-29-2009
(bear or transmission channel) and (packet with data service and different with charg\$3 and PDP context)	PGPB, USPT, USOC, EPAB, JPAB, DWPI, TDBD	ADJ	YES		10-29-2009
charg\$3 with rule	PGPB, USPT, USOC, EPAB, JPAB, DWPI, TDBD	ADJ	YES		10-29-2009
(charg\$3 with rule) and (different with charg\$3 and PDP context)	PGPB, USPT, USOC, EPAB, JPAB, DWPI, TDBD	ADJ	YES		10-29-2009

tpf	PGPB, USPT, USOC, EPAB, JPAB, DWPI, TDBD	ADJ	YES		10-29-2009
(tpf) and (PDP context)	PGPB, USPT, USOC, EPAB, JPAB, DWPI, TDBD	ADJ	YES		10-29-2009
(tpf and PDP context) and (charg\$3 with rule)	PGPB, USPT, USOC, EPAB, JPAB, DWPI, TDBD	ADJ	YES		10-29-2009
(tpf and PDP context and charg\$3 with rule) not (charg\$3 with rule and different with charg\$3 and PDP context)	PGPB, USPT, USOC, EPAB, JPAB, DWPI, TDBD	ADJ	YES		10-29-2009
crf	PGPB, USPT, USOC, EPAB, JPAB, DWPI, TDBD	ADJ	YES		10-29-2009
(crf) and (tpf)	PGPB, USPT, USOC, EPAB, JPAB, DWPI, TDBD	ADJ	YES		10-29-2009
(crf and tpf) and (PDP context)	PGPB, USPT, USOC, EPAB, JPAB, DWPI, TDBD	ADJ	YES		10-29-2009
(crf and tpf) not (crf and tpf and PDP context)	PGPB, USPT, USOC, EPAB, JPAB, DWPI, TDBD	ADJ	YES		10-29-2009
(crf and tpf not crf and tpf and PDP context) and (charg\$3 with rule)	PGPB, USPT, USOC, EPAB, JPAB, DWPI, TDBD	ADJ	YES		10-29-2009
charg\$3 (policy or rule)	PGPB, USPT, USOC, EPAB, JPAB, DWPI, TDBD	ADJ	YES		11-02-2009
pdp context	PGPB, USPT, USOC, EPAB, JPAB, DWPI, TDBD	ADJ	YES		11-02-2009
(pdp context) and (charg\$3 (policy or rule))	PGPB, USPT, USOC, EPAB, JPAB, DWPI, TDBD	ADJ	YES		11-02-2009
tieu.xp.	PGPB, USPT, USOC, EPAB, JPAB, DWPI, TDBD	ADJ	YES		11-02-2009
(tieu.xp.) and (tieu.xp.)	PGPB, USPT, USOC, EPAB, JPAB, DWPI, TDBD	ADJ	YES		11-02-2009

(tieu.xp. and tieu.xp.) and (pdp context and charg\$3 (policy or rule))	PGPB, USPT, USOC, EPAB, JPAB, DWPI, TDBD	ADJ	YES		11-02-2009
(charg\$3 (policy or rule)) and (tieu.xp.)	PGPB, USPT, USOC, EPAB, JPAB, DWPI, TDBD	ADJ	YES		11-02-2009
370/\$.ccls.	PGPB, USPT, USOC, EPAB, JPAB, DWPI, TDBD	ADJ	YES		11-02-2009
(370/\$.ccls.) and (tieu.xp.)	PGPB, USPT, USOC, EPAB, JPAB, DWPI, TDBD	ADJ	YES		11-02-2009
(pdp context) and (370/\$.ccls. and tieu.xp.)	PGPB, USPT, USOC, EPAB, JPAB, DWPI, TDBD	ADJ	YES		11-02-2009
crf	PGPB, USPT, USOC, EPAB, JPAB, DWPI, TDBD	ADJ	YES		11-02-2009
(crf) and (charg\$3 (policy or rule))	PGPB, USPT, USOC, EPAB, JPAB, DWPI, TDBD	ADJ	YES		11-02-2009
(crf and charg\$3 (policy or rule)) and (pdp context)	PGPB, USPT, USOC, EPAB, JPAB, DWPI, TDBD	ADJ	YES		11-02-2009
(crf and charg\$3 (policy or rule)) not (crf and charg\$3 (policy or rule) and pdp context)	PGPB, USPT, USOC, EPAB, JPAB, DWPI, TDBD	ADJ	YES		11-02-2009



Form PTO-1449 (Modified)	U.S. Department of Commerce Patent and Trademark Office	Atty. Docket No. 30952/42236	Serial No. 11/502,921
SECOND SUPPLEMENTAL INFORMATION DISCLOSURE STATEMENT		Applicant Xiaoqin Duan	
		Filing Date March 28, 2005	Group 2616

U.S. PATENT DOCUMENTS							
*Examiner Initials	Document Number	Issue Date	Name	Class	Subclass	Filing Date if Appropriate	
	2003/153333	08-14-2003	Shirai et al.	455	466		

FOREIGN PATENT DOCUMENTS							
*Examiner Initials	Document Number	Publication Date	Country	Class	Subclass	Translation	
						Yes	No
	2003-152778	05-23-2003	JP			Abstract Only	
	WO-02/093835	11-21-2002	PCT			Abstract Only	

OTHER DOCUMENTS (Including Author, Title, Date, Pertinent Pages, etc.)	
	English-language translation of Official Action for correspondence Japanese Application No. 2007-503178, dated July 14, 2009.

Examiner	Date Considered
*EXAMINER: Initial if reference considered, whether or not citation is in conformance with MPEP 609; Draw line through citation if not in conformance and not considered. Include copy of this form with next communication to applicant.	

Publication number: JP2003152778 (A)

Also published as:

Publication date: 2003-05-23

 JP3553918 (B2)

Inventor(s): MINATO KENJI; YADA KOJI

Applicant(s): NIPPON TELEGRAPH & TELEPHONE

Classification:

- **international:** H04L12/56; H04L12/14; H04L12/46;
H04L12/56; H04L12/14; H04L12/46;
(IPC1-7): H04L12/56; H04L12/14;
H04L12/46

- **European:**

Application number: JP20010348954 20011114

Priority number(s): JP20010348954 20011114

[View INPADOC patent family](#)

[View list of citing documents](#)

[Report a data error here](#)

Abstract of **JP 2003152778 (A)**

PROBLEM TO BE SOLVED:

To provide an edge router device capable of being set so as to be able to transmit a high priority packet to a client side user terminal without allowing the manager of a server side user terminal to have to be aware of the packet transmission and in addition, being automatically set so as to make the manager of the client side user terminal pay the charge of the high priority packet, who has requested the high priority packet, a network management system, its program and a network managing method.

SOLUTION: A client side edge router device 110A changes a policy table on the basis of a policy setting request transmitted by the client side user terminal 12A and also transfers the policy setting request to an edge router device 110B with the server side user terminal 12B connected thereto through a network managing device 130.; The server side edge router device 110B changes its policy table and charging table on the basis of the received policy setting request.

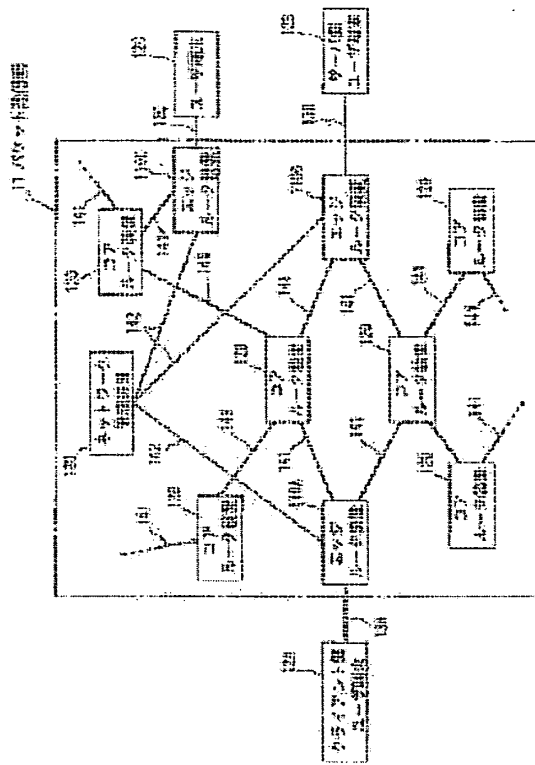

(19)日本国特許庁 (J P)

(12) 公開特許公報 (A)

(11)特許出願公開番号
特開2003-152778
(P2003-152778A)

(43)公開日 平成15年5月23日(2003.5.23)

(51)Int.Cl.7	識別記号	F I	データベース(参考)
H04L 12/56	100	H04L 12/56	100C 5K030
12/14		12/14	5K033
12/46	100	12/46	100R

審査請求 未請求 請求項の数14 O L (全 15 頁)

(21)出願番号 特願2001-348954(P2001-348954)
 (22)出願日 平成13年11月14日(2001.11.14)

(71)出願人 000004226
 日本電信電話株式会社
 東京都千代田区大手町二丁目3番1号
 (72)発明者 深 賢治
 東京都千代田区大手町二丁目3番1号 日本電信電話株式会社内
 (72)発明者 矢田 浩二
 東京都千代田区大手町二丁目3番1号 日本電信電話株式会社内
 (74)代理人 100069981
 弁理士 吉田 裕孝

最終頁に続く

(54)【発明の名称】 エッジルータ装置及びネットワーク管理システムとそのプログラム並びにネットワーク管理方法

(57)【要約】

【課題】 サーバ側ユーザ端末の管理者が全く意識する必要なしにクライアント側ユーザ端末に対して高優先度のパケットを送信できるように設定することができ、さらには、その課金を高優先度パケットを要求したクライアント側ユーザ端末の管理者が支払うように自動的に設定できるエッジルータ装置及びネットワーク管理システムとそのプログラム並びにネットワーク管理方法を提供する。

【解決手段】 クライアント側ユーザ端末12Aが送信したポリシー設定要求に基づいてクライアント側エッジルータ装置110Aがポリシーテーブルを変更すると共に、エッジルータ装置110Aはポリシー設定要求をネットワーク管理装置130を介してサーバ側ユーザ端末12Bが接続されたエッジルータ装置110Bに転送し、サーバ側エッジルータ装置110Bは受信したポリシー設定要求に基づいてポリシーテーブルと課金テーブルを変更する。

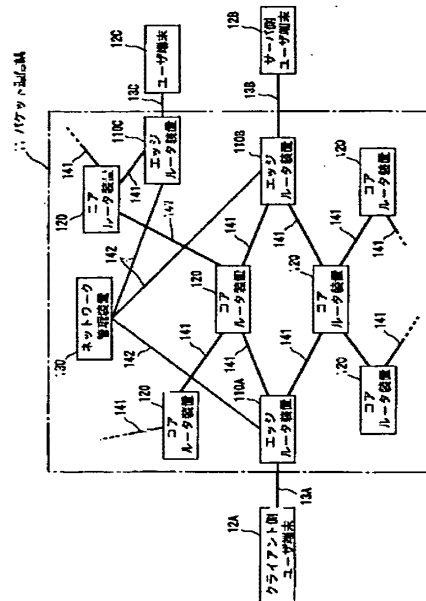

【特許請求の範囲】

【請求項1】 バケットの優先度を設定してバケット転送可能なバケット通信網の末端に設けられ、該バケット通信網以外のユーザ端末からのアクセス線路を前記バケット通信網に接続する手段と、少なくともバケットの送信元アドレスと送信先アドレス及びバケット優先度が1組の情報として格納されるポリシーテーブルと、前記ユーザ端末が送信したバケットの優先度を前記ポリシーテーブルに従って変更する手段とを有するエッジルータ装置であって、

前記ユーザ端末から送信され、少なくともバケットの送信元アドレスと、送信先アドレス、バケット優先度のそれぞれの情報を含むポリシー設定要求のバケットを前記アクセス線路から受信する手段と、

前記ユーザ端末から受信したポリシー設定要求のバケットから該ポリシー設定要求を送信したユーザ端末のアドレスを抽出する手段と、

前記ユーザ端末から受信したポリシー設定要求に含まれる送信元アドレスと前記抽出したユーザ端末のアドレスが同一であるときに、前記ポリシーテーブルの内容を前記ポリシー設定要求の内容に基づいて変更する手段と、前記ユーザ端末から受信したポリシー設定要求の送信先アドレスと前記抽出したユーザ端末のアドレスが同一であるときに、前記ポリシー設定要求をネットワーク管理装置へ転送する手段と、

前記ネットワーク管理装置からポリシー設定要求を受信する手段と、

前記ネットワーク管理装置から受信したポリシー設定要求の内容に基づいて前記ポリシーテーブルの内容を変更する手段とを備えていることを特徴とするエッジルータ装置。

【請求項2】 前記ユーザ端末から受信したポリシー設定要求のバケットのヘッダ部から該ポリシー設定要求を送信したユーザ端末のアドレスを抽出する手段を備えていることを特徴とする請求項1に記載のエッジルータ装置。

【請求項3】 前記アクセス線路で接続されるユーザ端末の管理者にとって課金対象となる受信バケットの種別情報と課金対象外となる送信バケットの種別情報を格納する課金テーブルと、

前記アクセス線路を介してユーザ端末から受信した通信バケットを課金対象とし且つ前記課金テーブルで指定されている受信バケットを課金対象とすると共に前記課金テーブルで指定されている送信バケットを課金対象外として前記アクセス線路で接続されるユーザ端末のバケット通信に課金する手段と、

前記ネットワーク管理装置から受信したポリシー設定要求で指定される通信バケットに対して該ポリシー設定要求に含まれる送信元アドレスで特定されるユーザ端末の管理者に課金しないように前記課金テーブルの内容を変

更する手段とを有することを特徴とする請求項1に記載のエッジルータ装置。

【請求項4】 バケットの優先度を設定可能なバケット通信網の末端に設けられ、該バケット通信網以外のユーザ端末からのアクセス線路を前記バケット通信網に接続する手段と、前記ユーザ端末が送信したバケットの優先度をポリシーテーブルに従って変更する手段とを有する複数のエッジルータ装置と、該エッジルータ装置と通信網を介して接続されたネットワーク管理装置とからなるネットワーク管理システムであって、

前記エッジルータ装置は、

前記ユーザ端末から送信され、少なくともバケットの送信元アドレスと、送信先アドレス、バケット優先度のそれぞれの情報を含むポリシー設定要求のバケットを前記アクセス線路から受信する手段と、

前記ユーザ端末から受信したポリシー設定要求のバケットから該ポリシー設定要求を送信したユーザ端末のアドレスを抽出する手段と、

前記ユーザ端末から受信したポリシー設定要求に含まれる送信元アドレスと前記抽出したユーザ端末のアドレスが同一であるときに、前記ポリシーテーブルの内容を前記ポリシー設定要求の内容に基づいて変更する手段と、前記ユーザ端末から受信したポリシー設定要求の送信先アドレスと前記抽出したユーザ端末のアドレスが同一であるときに、前記ポリシー設定要求をネットワーク管理装置へ転送する手段と、

前記ネットワーク管理装置からポリシー設定要求を受信する手段と、

前記ネットワーク管理装置から受信したポリシー設定要求の内容に基づいて前記ポリシーテーブルの内容を変更する手段とを備え、

前記ネットワーク管理装置は、

前記エッジルータ装置から前記通信網を介して送信されたポリシー設定要求を受信する手段と、

該受信したポリシー設定要求に含まれる送信元アドレスを抽出する手段と、

該抽出した送信元アドレスのユーザ端末と前記アクセス線路によって接続されているエッジルータ装置へ前記受信したポリシー設定要求を転送する手段とを備えていることを特徴とするネットワーク管理システム。

【請求項5】 前記エッジルータ装置は、前記ユーザ端末から受信したポリシー設定要求のバケットのヘッダ部から該ポリシー設定要求を送信したユーザ端末のアドレスを抽出する手段を備えていることを特徴とする請求項4に記載のネットワーク管理システム。

【請求項6】 前記エッジルータ装置は、

前記アクセス線路で接続されるユーザ端末の管理者にとって課金対象となる受信バケットの種別情報と課金対象外となる送信バケットの種別情報を格納する課金テーブルと、

前記アクセス線路を介してユーザ端末から受信した通信パケットを課金対象とし且つ前記課金テーブルで指定されている受信パケットを課金対象とすると共に前記課金テーブルで指定されている送信パケットを課金対象外として前記アクセス線路で接続されるユーザ端末のバケット通信に課金する手段と、

前記ネットワーク管理装置から受信したポリシー設定要求で指定される通信パケットに対して該ポリシー設定要求に含まれる送信元アドレスで特定されるユーザ端末の管理者に課金しないように前記課金テーブルの内容を変更する手段とを有することを特徴とする請求項4に記載のネットワーク管理システム。

【請求項7】 バケットの優先度を設定してバケット転送可能なバケット通信網の末端に設けられ、該バケット通信網以外のユーザ端末からのアクセス線路を前記バケット通信網に接続する手段と、少なくともバケットの送信元アドレスと送信先アドレス及びバケット優先度が1組の情報として格納されるポリシーテーブルと、前記ユーザ端末が送信したバケットの優先度を前記ポリシーテーブルに従って変更する手段とを有するコンピュータを主体として構成されたエッジルータ装置のコンピュータプログラムであって、

前記ユーザ端末から送信され、少なくともバケットの送信元アドレスと、送信先アドレス、バケット優先度のそれぞれの情報を含むポリシー設定要求のパケットを前記アクセス線路から受信したときに、該受信したポリシー設定要求のパケットから該ポリシー設定要求を送信したユーザ端末のアドレスを抽出するステップと、

前記ユーザ端末から受信したポリシー設定要求に含まれる送信元アドレスと前記抽出したユーザ端末のアドレスが同一であるときに、前記ポリシーテーブルの内容を前記ポリシー設定要求の内容に基づいて変更するステップと、

前記ユーザ端末から受信したポリシー設定要求の送信先アドレスと前記抽出したユーザ端末のアドレスが同一であるときに、前記ポリシー設定要求をネットワーク管理装置へ転送するステップと、

前記ネットワーク管理装置からポリシー設定要求を受信したときに、該ネットワーク管理装置から受信したポリシー設定要求の内容に基づいて前記ポリシーテーブルの内容を変更するステップとを含むことを特徴とするエッジルータ装置のコンピュータプログラム。

【請求項8】 ユーザ端末からのアクセス線路をバケット通信網に接続する手段と、少なくともバケットの送信元アドレスと送信先アドレス及びバケット優先度が1組の情報として格納されるポリシーテーブルと、前記ユーザ端末が送信したバケットの優先度を前記ポリシーテーブルに従って変更する手段と、前記ユーザ端末の管理者にとって課金対象となる受信パケットの種別情報と課金対象外となる送信パケットの種別情報が格納されている

課金テーブルと、前記アクセス線路を介してユーザ端末から受信した通信パケットを課金対象とし且つ前記課金テーブルで指定されている受信パケットを課金対象とすると共に前記課金テーブルで指定されている送信パケットを課金対象外として前記ユーザ端末のバケット通信に課金する手段とを有するコンピュータを主体として構成されたエッジルータ装置のコンピュータプログラムであって、

前記ユーザ端末から送信され、少なくともバケットの送信元アドレスと、送信先アドレス、バケット優先度のそれぞれの情報を含むポリシー設定要求のパケットを前記アクセス線路から受信したときに、該受信したポリシー設定要求のパケットから該ポリシー設定要求を送信したユーザ端末のアドレスを抽出するステップと、

前記ユーザ端末から受信したポリシー設定要求に含まれる送信元アドレスと前記抽出したユーザ端末のアドレスが同一であるときに、前記ポリシーテーブルの内容を前記ポリシー設定要求の内容に基づいて変更するステップと、

前記ユーザ端末から受信したポリシー設定要求の送信先アドレスと前記抽出したユーザ端末のアドレスが同一であるときに、前記ポリシー設定要求をネットワーク管理装置へ転送するステップと、

前記ネットワーク管理装置からポリシー設定要求を受信したときに、該ネットワーク管理装置から受信したポリシー設定要求の内容に基づいて前記ポリシーテーブルの内容を変更するステップと、

前記ネットワーク管理装置から受信したポリシー設定要求で指定される通信パケットに対して該ポリシー設定要求に含まれる送信元アドレスで特定されるユーザ端末の管理者に課金しないように前記課金テーブルの内容を変更するステップとを含むことを特徴とするエッジルータ装置のコンピュータプログラム。

【請求項9】 前記ユーザ端末から受信したポリシー設定要求のパケットのヘッダ部から前記ユーザ端末のアドレスを抽出するステップを含むことを特徴とする請求項7または請求項8に記載のエッジルータ装置のコンピュータプログラム。

【請求項10】 バケットの優先度を設定してバケット転送可能なバケット通信網の末端に設けられ、且つ該バケット通信網以外のユーザ端末からのアクセス線路を前記バケット通信網に接続する手段と、前記ユーザ端末が送信したバケットの優先度をポリシーテーブルに従って変更する手段とを有する複数のエッジルータ装置に対して通信網を介して接続されたコンピュータを主体として構成されているネットワーク管理装置のコンピュータプログラムであって、

前記エッジルータ装置から前記通信網を介して送信されたポリシー設定要求を受信するステップと、

該受信したポリシー設定要求に含まれる送信元アドレス

を抽出して、該抽出した送信元アドレスのユーザ端末と前記アクセス線路によって接続されているエッジルータ装置へ前記受信したポリシー設定要求を転送するステップとを含むことを特徴とするネットワーク管理装置のコンピュータプログラム。

【請求項11】 前記請求項7乃至請求項10の何れかに記載のコンピュータプログラムが記録されているコンピュータ読み取り可能な情報記録媒体。

【請求項12】 パケットの優先度を設定可能なパケット通信網の末端に設けられ、且つ該パケット通信網以外のユーザ端末からのアクセス線路を前記パケット通信網に接続する手段と、前記ユーザ端末が送信したパケットの優先度をポリシーテーブルに従って変更する手段とを有する複数のエッジルータ装置と、該エッジルータ装置に対して通信網を介して接続されたネットワーク管理装置とからなるネットワークシステムのネットワーク管理方法であって、

前記エッジルータ装置は、

前記ユーザ端末から送信され、少なくともパケットの送信元アドレスと、送信先アドレス、パケット優先度のそれぞれを含むポリシー設定要求のパケットを前記アクセス線路から受信したときに、該受信したポリシー設定要求のパケットから該ポリシー設定要求を送信したユーザ端末のアドレスを抽出し、

前記ユーザ端末から受信したポリシー設定要求に含まれる送信元アドレスと前記抽出したユーザ端末のアドレスが同一であるときに、前記ポリシーテーブルの内容を前記ポリシー設定要求の内容に基づいて変更し、

前記ユーザ端末から受信したポリシー設定要求の送信先アドレスと前記抽出したユーザ端末のアドレスが同一であるときに、前記ポリシー設定要求をネットワーク管理装置へ転送し、

前記ネットワーク管理装置からポリシー設定要求を受信したときに、該ネットワーク管理装置から受信したポリシー設定要求の内容に基づいて前記ポリシーテーブルの内容を変更し、

前記ネットワーク管理装置は、

前記エッジルータ装置から前記通信網を介して送信されたポリシー設定要求を受信し、

該受信したポリシー設定要求に含まれる送信元アドレスを抽出して、該抽出した送信元アドレスのユーザ端末と前記アクセス線路によって接続されているエッジルータ装置へ前記受信したポリシー設定要求を転送することを特徴とするネットワーク管理方法。

【請求項13】 前記エッジルータ装置は、前記ユーザ端末から受信したポリシー設定要求のパケットのヘッダ部の内容から前記ユーザ端末のアドレスを抽出することを特徴とする請求項12に記載のネットワーク管理方法。

【請求項14】 前記エッジルータ装置は、

前記アクセス線路で接続されるユーザ端末の管理者にとって課金対象となる受信パケットの種別情報と課金対象外となる送信パケットの種別情報とを課金テーブルに格納して保持し、

前記アクセス線路を介してユーザ端末から受信した通信パケットを課金対象とし且つ前記課金テーブルで指定されている受信パケットを課金対象とすると共に前記課金テーブルで指定されている送信パケットを課金対象外として前記アクセス線路で接続されるユーザ端末のパケット通信に課金し、

前記ネットワーク管理装置から受信したポリシー設定要求で指定される通信パケットに対して該ポリシー設定要求に含まれる送信元アドレスで特定されるユーザ端末の管理者に課金しないように前記課金テーブルの内容を変更することを特徴とする請求項12に記載のネットワーク管理方法。

【発明の詳細な説明】

【0001】

【発明の属する技術分野】本発明は、Diff-servなどのパケット優先度を設定可能なパケット通信網において、クライアント側ユーザ端末からの操作でサーバ側ユーザ端末が送信するパケットの優先度を変更可能なエッジルータ装置及びネットワーク管理システムとそのプログラム並びにネットワーク管理方法に関するものである。

【0002】

【従来の技術】パケット通信網には複数種の通信網が存在するが、その中にはパケットに優先度を付けて優先度の高いパケットほど高速にパケットを転送することができるパケット通信網が存在する。その一例としてDiff-servベースのパケット通信網を挙げることができる。

【0003】図9に従来例としてのDiff-servベースパケット通信網の構成を示す。図において、21はパケット通信網で、通信網の末端に設けられた複数のエッジルータ装置210と、複数のコアルータ装置220とを備え、エッジルータ装置210とコアルータ装置220との間及び複数のコアルータ装置220間はパケット通信線241を介して接続されている。さらに、各エッジルータ装置210は制御通信網242を介してネットワーク管理装置230に接続されている。

【0004】上記構成のDiff-servベースのパケット通信網21では、パケットに優先度を付けてその優先度に従って各ルータでパケットを配送することができる。

【0005】パケットに優先度を付ける方法としては2種類の方法がある。その一つは、ユーザ端末22において、パケットのヘッダ部分の優先度フィールドに優先度を付加してパケット通信網21に送信する方法である。他の一つはアクセス線路24を介してユーザ端末22が接続されたエッジルータ装置210内のポリシー制御部211において、ユーザ端末22が送信したパケットのヘッダ部分の優先度フィールドを変更する方法である。

【0006】図10に、エッジルータ装置210の一構成例を示す。このエッジルータ装置210は、ポリシー制御部211と、ポリシーテーブル212、パケット課金部213を備え、ポリシーテーブル212には、パケットの送信元アドレス、送信先アドレス、パケット優先度が1組の情報として複数の情報がリストとして保存されている。

【0007】ポリシー制御部211は、ユーザ端末22からアクセス線路24を介してパケット301を受信すると、そのパケット301のヘッダ部分にある送信元アドレスと送信先アドレスを取得してポリシーテーブル212内の情報と比較する。この比較の結果、該当する情報がポリシーテーブル212にあれば、その中に記録されている優先度をパケット301のヘッダ部分の優先度フィールドに付加したパケット302を生成してパケット通信網21内のコアルータ装置220に送信する。上記2つの方法の何れかによって、パケット301を送信するユーザ端末22で優先度を付加したパケットを生成する、もしくはアクセス線路24を介してユーザ端末22に接続されているエッジルータ装置210のポリシー制御部301において優先度を付加したパケット302を生成して、このパケット302をコアルータ装置220へ送信し、高優先度のパケットほど高速に転送することができる。

【0008】また、上記エッジルータ装置210において、優先度が付けられたパケットをカウントして課金することができる。この場合、エッジルータ装置210のパケット課金部213において、通過するパケットを優先度毎に分類して、パケット数と各パケットのバイト長をカウントする。このカウントした値は、一定期間毎にネットワーク管理装置230によって制御通信網242を介して集計され、優先度毎の料金を掛け合わせた値がユーザ端末22の管理者に課金される。

【0009】ここで、カウント対象のパケットには、ユーザ端末22が送信するパケットと、ユーザ端末22に送られてくるパケットの2種類があるが、どちらか一方のパケットをカウントして課金するか、もしくは両方をカウントして課金するかは、ネットワークサービス提供者の課金ポリシーに依存する。

【0010】このようにして従来は、パケットの送信側においてのみパケットに優先度を付加して、その優先度付きパケットの課金処理を行えるようになっていた。

【0011】

【発明が解決しようとする課題】しかしながら、前述した従来例では、パケットの優先度を変更できるのは、送信側のみであった。さらに、パケットに対する課金処理に関しても、送信パケットだけに課金するか、送受信の両方のパケットに課金するかのどちらかを固定的に選択できるだけであった。

【0012】このような従来例の方式は、クライアント・サーバ形式でパケット転送を行う場合に多くの問題点があった。クライアント・サーバ形式とは、クライアン

ト側ユーザ端末がサーバ側ユーザ端末に要求を出して、サーバ側ユーザ端末から情報を入手する形式である。一例としては、クライアント側ユーザ端末がサーバ側ユーザ端末に要求を出して、サーバ側ユーザ端末が保持しているファイルをダウンロードする場合がある。さらに、サーバ側ユーザ端末が、音楽や映像等のストリーム型のデータを保持していて、クライアント側ユーザ端末がサーバ側ユーザ端末に要求してそれらのストリームデータを入手する場合がある。

【0013】このクライアント・サーバ形式では、データを要求するのはクライアント側ユーザ端末であるが、そのデータを送信するのはサーバ側ユーザ端末である。このためクライアント側ユーザ端末が、サーバ側ユーザ端末からのデータを高優先パケットで配送してほしい場合は、クライアント側ユーザ端末の管理者がサーバ側ユーザ端末の管理者になんらかの方法で連絡をしてサーバ側ユーザ端末の送信パケットの優先度を変更してもらう必要がある。

【0014】さらに、サーバ側ユーザ端末が送信するパケットの課金はサーバ側ユーザ端末の管理者に課されるため、サーバ側ユーザ端末の管理者は高優先パケットの料金を何らかの方法でクライアント側ユーザ端末の管理者に支払ってもらう必要がある。もし、クライアント側のエッジルータ装置210でクライアント側ユーザ端末が送信したパケットとクライアント側ユーザ端末がサーバ側ユーザ端末から受信したパケットの両方のパケットに対して課金するという課金ポリシーにすれば、サーバ側では課金されないが、クライアント側ユーザ端末内のアプリケーションの中にサーバとして情報を提供するアプリケーションが混在している場合は問題の解決にはならない。

【0015】このように従来方式では、クライアント側ユーザ端末の管理者とサーバ側ユーザ端末の管理者で何らかの方法で連絡を取り、パケット優先度の変更と課金処理の付け替えをする必要がある。この連絡による方法は取引の信用度を確保するために複雑な処理が必要となる。また、フリーソフトを配布するような決済手段を持っていないサーバでは、クライアントからの高優先度パケットによる配送要求に答えるために決済手段を持つのは運営上困難である。さらに、個人レベルでパケット網に常時接続して自由に情報発信をするような使い方を考えた場合に、個人レベルで立ち上げたサーバに複雑な取引システムをサポートさせることは、大衆のネットワーク通信への参加を阻害する要因にもなる。

【0016】本発明の目的は上記の問題点に鑑み、サーバ側ユーザ端末の管理者が全く意識する必要なしにクライアント側ユーザ端末に対して高優先度のパケットを送信できるように設定することができ、さらには、その課金を高優先度パケットを要求したクライアント側ユーザ端末の管理者が支払うように自動的に設定できるエッジ

ルータ装置及びネットワーク管理システムとそのプログラム並びにネットワーク管理方法を提供することである。

【0017】

【課題を解決するための手段】本発明は上記の目的を達成するために、パケットの優先度を設定可能なパケット通信網の末端に設けられ、該パケット通信網以外のユーザ端末からのアクセス線路を前記パケット通信網に接続する手段と、前記ユーザ端末が送信したパケットの優先度をポリシーテーブルに従って変更する手段とを有する複数のエッジルータ装置と、該エッジルータ装置と通信網を介して接続されたネットワーク管理装置とからなるネットワーク管理システムにおける前記エッジルータ装置とネットワーク管理装置を次のように構成した。

【0018】前記エッジルータ装置は、前記ユーザ端末から送信され、少なくともパケットの送信元アドレスと、送信先アドレス、パケット優先度のそれぞれの情報を含むポリシー設定要求のパケットを前記アクセス線路から受信する手段と、前記ユーザ端末から受信したポリシー設定要求のパケットから該ポリシー設定要求を送信したユーザ端末のアドレスを抽出する手段と、前記ユーザ端末から受信したポリシー設定要求に含まれる送信元アドレスと前記抽出したユーザ端末のアドレスが同一であるときに、前記ポリシーテーブルの内容を前記ポリシー設定要求の内容に基づいて変更する手段と、前記ユーザ端末から受信したポリシー設定要求の送信先アドレスと前記抽出したユーザ端末のアドレスが同一であるときに、前記ポリシー設定要求をネットワーク管理装置へ転送する手段と、前記ネットワーク管理装置からポリシー設定要求を受信する手段と、前記ネットワーク管理装置から受信したポリシー設定要求の内容に基づいて前記ポリシーテーブルの内容を変更する手段とを備えている。

【0019】また、前記ネットワーク管理装置は、前記エッジルータ装置から前記通信網を介して送信されたポリシー設定要求を受信する手段と、該受信したポリシー設定要求に含まれる送信元アドレスを抽出する手段と、該抽出した送信元アドレスのユーザ端末と前記アクセス線路によって接続されているエッジルータ装置へ前記受信したポリシー設定要求を転送する手段とを備えている。

【0020】上記ネットワーク管理システムでは、ユーザ端末からポリシー設定要求を送信することにより、このユーザ端末から特定の送信先アドレスのユーザ端末に送信されるパケットの優先度を変更することができる。共に、特定の送信元アドレスのユーザ端末から自己ユーザ端末に送信されるパケットの優先度を変更することができる。

【0021】即ち、ユーザ端末から送信されるポリシー設定要求のパケットには、少なくともパケットの送信元アドレスと、送信先アドレス、パケット優先度のそれぞ

れの情報が含まれている。このポリシー設定要求のパケットは、エッジルータ装置によって受信される。このエッジルータ装置は、パケットの優先度を設定可能なパケット通信網の末端に設けられて、このパケット通信網以外のユーザ端末からのアクセス線路を前記パケット通信網に接続する装置であり、前記パケット通信網内のパケット優先度を設定したパケット転送をすることができる。

【0022】前記エッジルータ装置は、前記ユーザ端末からポリシー設定要求のパケットを受信すると、ユーザ端末から受信したポリシー設定要求のパケットから、このポリシー設定要求を送信したユーザ端末のアドレスを抽出し、このポリシー設定要求に含まれる送信元アドレスと前記抽出したユーザ端末のアドレスが同一であるときに、ポリシーテーブルの内容を前記ポリシー設定要求の内容に基づいて変更する。また、エッジルータ装置は、前記ユーザ端末から受信したポリシー設定要求の送信先アドレスと前記抽出したユーザ端末のアドレスが同一であるときに、前記ポリシー設定要求をネットワーク管理装置へ転送する。さらに、エッジルータ装置は、他のエッジルータ装置から前記ネットワーク管理装置を介してポリシー設定要求を受信したときに、この受信したポリシー設定要求の内容に基づいて前記ポリシーテーブルの内容を変更する。

【0023】また、前記ネットワーク管理装置は、エッジルータ装置から通信網を介して送信されたポリシー設定要求を受信し、この受信したポリシー設定要求に含まれる送信元アドレスを抽出して、抽出した送信元アドレスのユーザ端末とアクセス線路によって接続されているエッジルータ装置へ前記受信したポリシー設定要求を転送する。

【0024】上記構成によって、例えば、クライアント側のユーザ端末がサーバ側のユーザ端末に要求を送信してサーバ側ユーザ端末から情報を入力するクライアント・サーバ形式の場合、クライアント側ユーザ端末からポリシー設定要求を送信して、サーバ側ユーザ端末からデータを高優先パケットで配送させることが可能となる。このとき、サーバ側ユーザ端末の管理者に対して連絡をしなくても、サーバ側ユーザ端末の送信パケットの優先度を変更することができる。従って、サーバ側ユーザ端末が保持している音楽や映像等のストリーム型のデータをクライアント側ユーザ端末がダウンロードするとき、サーバ側ユーザ端末の送信パケットの優先度を変更することにより、高速なダウンロードが可能となる。

【0025】また、本発明では、エッジルータ装置に、ユーザ端末から受信したポリシー設定要求のパケットのヘッダ部の内容から、このポリシー設定要求を送信したユーザ端末のアドレスを抽出する手段を備えた。これにより、ポリシー設定要求を送信したユーザ端末のアドレスを容易に且つ確実に抽出することができる。

【0026】また、本発明では、エッジルータ装置が、アクセス線路で接続されるユーザ端末の管理者にとって課金対象となる受信パケットの種別情報と課金対象外となる送信パケットの種別情報を格納する課金テーブルと、この課金テーブルに従って前記アクセス線路で接続されるユーザ端末のパケット通信に課金する手段を備えることにより、上記ポリシー設定要求によって生じた高優先度通信パケットに対する課金が、上記ポリシー設定要求を送信したユーザ端末の管理者に対して自動的に課せられるようにした。

【0027】即ち、このネットワーク管理システムでは、エッジルータ装置に、アクセス線路を介してユーザ端末から受信した通信パケットを課金対象とし且つ前記課金テーブルで指定されている受信パケットを課金対象とすると共に前記課金テーブルで指定されている送信パケットを課金対象外として前記アクセス線路で接続されるユーザ端末のパケット通信に課金する手段と、ネットワーク管理装置から受信したポリシー設定要求で指定される通信パケットに対してこのポリシー設定要求に含まれる送信元アドレスで特定されるユーザ端末の管理者に課金しないように課金テーブルの内容を変更する手段とを備えた。

【0028】上記構成によって、例えば前述した一例のクライアント・サーバ形式のように、クライアント側ユーザ端末の管理者がポリシー設定要求を送信して、サーバ側ユーザ端末からデータを高優先パケットで配送させるように設定したときに、このポリシー設定要求によって生じた高優先度通信パケットに対する課金は、上記ポリシー設定要求を送信した管理者に対して自動的に課せられるようになる。

【0029】

【発明の実施の形態】以下、図面に基づいて本発明の一実施形態を説明する。

【0030】図1は本発明の一実施形態におけるパケット通信網及びネットワーク管理システムを示す構成図である。図において、11はDiff-servベースのパケット通信網で、通信網の末端に設けられた複数のエッジルータ装置110(110A, 110B, 110C, ...)と、複数のコアルータ装置120とを備え、各エッジルータ装置110の間には1つ以上のコアルータ装置120がパケット通信線141を介して接続されている。さらに、各エッジルータ装置110は制御通信網142を介して、このパケット通信網11を管理するネットワーク管理装置130に接続されている。また、各ユーザ端末12(12A, 12B, 12C)がアクセス線路13(13A, 13B, 13C)を介してエッジルータ装置110(110A, 110B, 110C)に接続されている。図1においては、クライアント側ユーザ端末12Aがアクセス線路13Aを介してエッジルータ装置110Aに接続され、サーバ側ユーザ端末12Bがアクセス線路13Bを介してエッジルータ装置110Bに接続され、ユーザ端末12Cがアクセス線路13Cを介してエッジルータ装

置110Cに接続されている。

【0031】エッジルータ装置110は、周知のコンピュータを主体として構成され、コンピュータプログラムに基づいて動作するもので、図2に示すように、ユーザ要求処理部401と、ポリシー制御部402、ポリシーテーブル403、パケット課金部404、課金テーブル405、ルーティング制御部406、主制御部407、通信処理部408、及びユーザ要求処理部401と、ポリシー制御部402、パケット課金部404、ルーティング制御部406を接続するパケット通信路410を備え、パケット通信網11と、ユーザ端末12及びこのパケット通信網11以外のパケット通信網との接続を行い、通信パケットの転送を行うと共に、通信パケットの優先度設定処理と通信パケットに対する課金処理を行う。

【0032】主制御部407は、通信処理部408と通信網142を介してネットワーク管理装置130との間で通信を行い、ネットワーク管理装置130から受信した制御命令を実行すると共にエッジルータ装置110内に保持している情報をネットワーク管理装置130に送信する。さらに、主制御部407は、制御バス409によってユーザ要求処理部401と、ポリシー制御部402、パケット課金部404、ルーティング制御部406に接続され、これらの動作制御を行う。

【0033】ユーザ要求処理部401は、アクセス線路13を介してユーザ端末12から受信した要求を受け付けて主制御部407に通知する。ユーザ要求処理部401の内部には、図3に示すように、Webサーバ411と要求処理サーバ412が存在し、これらはアクセス線路13に接続されたパケット通信路410に接続されている。つまり、Webサーバ411と要求処理サーバ412は特定のポート番号で起動しているネットワーク上のアプリケーションである。ユーザ端末12の管理者は、Web端末で要求を出す場合はWebサーバ411にアクセスし、ユーザ端末12上のアプリケーションから通信によって要求を出したい場合は要求処理サーバ412にアクセスする。どちらも受け付ける情報の内容は同じであり、その手段が異なるだけである。

【0034】ポリシー制御部402は、ポリシーテーブル403を参照してポリシー制御を行う。ポリシーテーブル403には、送信元アドレスと、送信元ポート番号、送信先アドレス、送信先ポート番号、プロトコル種別、パケット優先度の各項目の情報を1組として、複数組の情報を保持するテーブルである。また、プロトコル種別は、パケットの種別を識別する項目で、本実施形態ではTcpかUdpが設定される。

【0035】ポリシー制御部402は、ユーザ端末12側のアクセス線路13からコアルータ装置120側のパケット通信線141へ向かって送信されるパケットのヘッダ情報を抽出して、このヘッダ情報に含まれる送信元アドレスと、送信元ポート番号、送信先アドレス、送信先ポート番号、プロトコル種別が、ポリシーテーブル403に存

在する情報と一致するか否かをチェックする。もし一致すれば、そのパケットの優先度をポリシーテーブル403に記載されている優先度に付け替える。また、ポリシーテーブル403内のどの情報とも一致しなければ、ポリシー制御部402はパケットの優先度を変えないでそのまま転送する。尚、ポリシーテーブル403において、送信元ポート番号が省略されていれば、すべての送信元ポート番号が対象となる。同様に送信先ポート番号が省略されていれば、すべての送信先ポート番号が対象となる。さらに、ポリシーテーブル403において、プロトコル種別が省略されていれば、すべてのプロトコルが対象になる。

【0036】パケット課金部404は、エッジルータ装置110にアクセス線路13で接続されたユーザ端末12の通信パケットに対して課金処理を行うものであり、課金テーブル405を参照して通過パケットのカウントとこれに基づくパケットの課金処理を行い、ユーザ端末12毎の集計結果をネットワーク管理装置130に通知する。

【0037】課金テーブル405は、通常の課金対象となる通信パケット以外に課金対象となる受信パケットの種別情報と、課金対象外となる送信パケットの種別情報が格納されているテーブルである。上記パケットの種別情報としては、送信元アドレスと、送信元ポート番号、送信先アドレス、送信先ポート番号、プロトコル種別、課金フラグの各項目の情報を1組として、複数組の情報が格納されている。ここで、課金フラグは、課金をするかしないかを指示する2値のフラグである。

【0038】また、パケット課金部404は、ユーザ端末12側のアクセス線路13からコアルータ装置120側のパケット通信線141へ向けて送信されるパケットは原則として課金対象とし、さらに上記課金テーブル405に指定されている受信パケットに対して課金すると共に、上記課金テーブル405に指定されている送信パケットに対して課金対象外とする。この課金されたパケットの料金は、ユーザ端末12の管理者に請求される。

【0039】ここで、パケット課金部404は、上記アクセス線路13で接続されたユーザ端末12からの送信パケットであっても、このパケットのヘッダ情報に含まれる送信元アドレスと、送信元ポート番号、送信先アドレス、送信先ポート番号、プロトコル種別が、課金テーブル405に存在するアドレス情報（送信元アドレス、送信元ポート番号、送信先アドレス、送信先ポート番号、プロトコル種別）と一致して、且つ、その課金フラグが課金しない設定になっている場合は、パケット課金部404は該当するパケットを課金対象にはしない。

【0040】逆にパケット課金部404は、コアルータ装置120側のパケット通信線141からユーザ端末12側のアクセス線路13へ向けて受信されるパケットは原則として課金対象とはしない。また、この受信パケットであっても、このパケットのヘッダ情報に含まれる送信元アド

レスと、送信元ポート番号、送信先アドレス、送信先ポート番号、プロトコル種別が、課金テーブル405に存在するアドレス情報（送信元アドレス、送信元ポート番号、送信先アドレス、送信先ポート番号、プロトコル種別）と一致して、且つ、その課金フラグが課金する設定になっている場合は、パケット課金部404は該当するパケットを課金対象とする。この受信パケットの料金は、パケットの送信先ユーザ端末12の管理者に請求される。

【0041】尚、ポリシーテーブル403と課金テーブル405を1つのテーブルにまとめることも可能であることは言うまでもない。その場合、その1つのテーブルが所持する情報は、送信元アドレス、送信元ポート番号、送信先アドレス、送信先ポート番号、プロトコル種別、パケット優先度、及び課金フラグになる。このまとめたテーブルは、ポリシー制御部402とパケット課金部404の両方から参照されることになる。

【0042】ルーティング制御部406は、アクセス線路13を介してユーザ端末12から送られてきたパケットに対して最適な経路のパケット通信線141を選択して転送すると共に、パケット通信線141を介してユーザ端末12に向けて送られてきたパケットをユーザ端末12に転送する。

【0043】ネットワーク管理装置130は、周知のコンピュータを主体として構成され、コンピュータプログラムに基づいて動作するもので、図4に示すように、主制御部501と、各エッジルータ装置110と制御通信網142を介して接続された通信処理部502、キーボードやモニター装置などを含む入出力部503、記憶部504を備え、ネットワーク内のエッジルータ装置110のアドレス情報を記憶部504に保持して、エッジルータ装置110と共にポリシー設定処理を行う。さらに、ネットワーク管理装置130は、エッジルータ装置110内で各ユーザ端末12への課金を集計し、各ユーザ端末12の管理者への請求書の発行処理を行う。

【0044】上記構成において、本発明のネットワーク管理システムは、各エッジルータ装置110とネットワーク管理装置130を含む。

【0045】次に、上記ネットワーク管理システムにおいて、ユーザ端末12からエッジルータ装置110に対してポリシー設定要求を送信することにより特定のユーザ端末との間のパケット優先度を変更する手順及び各装置における処理について図5乃至図7のフローチャートを参照して説明する。

【0046】ここでは、クライアント・サーバ形式を例にとり、クライアント側ユーザ端末12Aがサーバ側ユーザ端末12Bに要求を出して、サーバ側ユーザ端末12Bからストリーム型のデータを入力する際に、サーバ側ユーザ端末12Bの送信パケットの優先度をクライアント側ユーザ端末12Aの管理者が変更する場合に重点を置いて説明

する。

【0047】クライアント側ユーザ端末12Aの管理者が、自己端末12Aからの送信パケットの優先度或いは特定のユーザ端末12から自己端末12Aへ送信されるパケットの優先度を変更したいときは、アクセス線路13を介して自己端末12Aが接続しているエッジルータ装置110Aにポリシー設定要求のパケットを送信する。

【0048】また、ポリシー設定要求には、優先度の変更対象となるパケットの送信側を特定するための送信元アドレスと送信元ポート番号、受信側を特定するための送信先アドレスと送信先ポート番号、パケットのプロトコル種別、及び変更後のパケット優先度の情報が記載される。尚、送信元ポート番号が省略されている場合は送信元アドレス上のすべてのポートが対象となる。同様に、送信先ポート番号が省略されている場合は送信先アドレス上のすべてのポートが対象となる。さらにプロトコル種別が省略されている場合はすべてのプロトコルが対象となる。

【0049】エッジルータ装置110は、ユーザ端末12からのポリシー設定要求を受信したか否かを監視する（SA1）と共に、ネットワーク管理装置130からポリシー設定要求を受信したか否かを監視している（SA14）。

【0050】ユーザ端末12が上記のポリシー設定要求を送信すると、このポリシー設定要求は、アクセス線路13Aを介してユーザ端末12に接続されたエッジルータ装置110のユーザ要求処理部401によって受け付けられる（SA2）。

【0051】ユーザ要求処理部401において、要求処理サーバ412が要求を受けた場合は、要求処理サーバ412はポリシー設定要求パケットのヘッダ部に格納されている情報からポリシー設定要求を送信したユーザ端末12のアドレスを要求元アドレスとして抽出する。また、Webサーバ411が要求を受けた場合は、Webのログイン処理によってユーザ端末12のアドレスが要求元アドレスとして抽出される（SA3）。この後、ユーザ要求処理部401は、ポリシー設定要求と抽出した要求元アドレスを主制御部407へ送る。

【0052】ユーザ要求処理部401からポリシー設定要求と要求元アドレスを受け取った主制御部407は、ポリシー設定要求の内容から送信元アドレスを抽出し（SA4）、この抽出した送信元アドレスと要求元アドレスが同一であるか否かを比較する（SA5）。この比較の結果、これらが異なるときは後述するSA7のエラー処理に移行し、同一の場合は変更命令と共にポリシー設定要求の内容をポリシー制御部402に送る。

【0053】尚、クライアント側ユーザ端末12Aの管理者が、自己ユーザ端末12Aから送信するパケットの優先度を変更する場合、送信元アドレスと要求元アドレスが同一になる。

【0054】変更命令と共にポリシー設定要求の内容を受け取ったポリシー制御部402は、ポリシー設定要求の内容に基づいてポリシーテーブル403の内容を変更する、或いはポリシー設定要求の内容をポリシーテーブル403に追加することによって、要求元アドレスのユーザ端末12から送信されるパケットの優先度を変更し、設定完了を主制御部407に通知し（SA6）、後述するSA12の処理に移行する。尚、前述したようにユーザ端末12の管理者が自己ユーザ端末12Aから送信するパケットの優先度を変更した場合、この変更に応じて自動的に課金され、上記管理者に請求されることになる。

【0055】一方、上記SA5の比較の結果、前記抽出した送信元アドレスと要求元アドレスが異なるときは、主制御部407は、ポリシー設定要求の内容から送信先アドレスを抽出し（SA7）、この抽出した送信先アドレスと要求元アドレスが同一であるか否かを比較する（SA8）。この比較の結果、送信先アドレスと要求元アドレスが異なる場合は後述するSA13の処理に移行し、これらが同一の場合は、このポリシー設定要求を制御通信網142を介してネットワーク管理装置130に転送する（SA9）。この後行われるネットワーク管理装置130における処理（SB1～SB9）と送信側のエッジルータ装置110における処理（SA14～SA18）に関しては後述する。

【0056】尚、クライアント側ユーザ端末12Aの管理者が、サーバ側ユーザ端末12Bから送信されるパケットの優先度を変更する場合、送信先アドレスと要求元アドレスが同一になる。

【0057】この後、主制御部407は、ネットワーク管理装置130から設定完了の通知を受信したか否かを監視し（SA10）、ネットワーク管理装置130から設定拒絶通知を受け取ったときは後述するSA13の処理に移行し、設定完了通知を受け取ったときは上記ポリシー設定要求のアドレス情報（送信元アドレス、送信元ポート番号、送信先アドレス、送信先ポート番号、プロトコル種別）で指定されるパケットを課金対象にするように課金テーブル405の内容を変更する（SA11）。

【0058】これにより、クライアント側ユーザ端末12Aの管理者がサーバ側ユーザ端末12Bから送信されるパケットの優先度を変更して高速転送できるようにしたときには、この高優先度パケットに対しては、クライアント側ユーザ端末12Aが接続されたエッジルータ装置110Aのパケット課金部404で課金され、このパケットに対する料金は、自動的にクライアント側ユーザ端末12Aの管理者に請求されることになる。

【0059】次いで、主制御部407は、ユーザ要求処理部401に命じてクライアント側ユーザ端末12Aに対して全ての設定が終了した旨を通知する（SA12）。

【0060】また、上記SA8の比較の結果、送信先アドレスと要求元アドレスが異なるとき、或いは、上記S

A10の判定の結果、ネットワーク管理装置130から設定拒絶通知を受け取ったときは、主制御部407は、エラー処理を行う(SA13)。

【0061】このエラー処理において、上記SA8の比較の結果、送信先アドレスと要求元アドレスが異なるときは、ポリシー設定要求を送信したユーザ端末12の管理者が自分とは全く無関係なユーザ端末12に係るポリシーを変更しようとしていることになるので、主制御部407は、エラーとしてポリシー設定要求を拒絶する旨を、ユーザ要求処理部401に命じてクライアント側ユーザ端末12Aに対して通知する。また、上記SA10の判定の結果、ネットワーク管理装置130から設定拒絶通知を受け取ったときは、主制御部407は、ポリシーの設定変更ができなかった旨を、ユーザ要求処理部401に命じてポリシー設定要求を送信したユーザ端末12に対して通知する。

【0062】一方、ネットワーク管理装置130では、主制御部501が、エッジルータ装置110からポリシー設定要求を受信したか否かを監視している(SB1)。上記SA9の処理においてエッジルータ装置110からネットワーク管理装置130にポリシー設定要求が転送されると、ネットワーク管理装置130の主制御部501は、通信処理部502を介してこのポリシー設定要求を受け取り(SB2)、ポリシー設定要求の内容から送信元アドレスを抽出する(SB3)。

【0063】次いで、ネットワーク管理装置103は、この送信元アドレスを収容するエッジルータが存在するか否かを判定する(SB4)。この判定の結果、ポリシー設定要求に含まれる送信元アドレスを収容するエッジルータ装置110が存在しないときは後述するSB9の処理に移行し、存在するときは、このポリシー設定要求を、送信元アドレスのユーザ端末12がアクセス線路13によって接続されているエッジルータ装置110に通信処理部502を介して転送する(SB5)。

【0064】例えば、上記のようにクライアント側ユーザ端末12Aの管理者が、サーバ側ユーザ端末12Bから自己ユーザ端末12Aに対して送信されるパケットの優先度を変更するときは、クライアント側ユーザ端末12Aから送信されたポリシー設定要求はエッジルータ装置110Aからネットワーク管理装置130を介してサーバ側ユーザ端末12Bがアクセス線路13によって接続されているエッジルータ装置110Bに転送される。これにより、ポリシー設定要求に基づくパケット優先度の変更処理がサーバ側のエッジルータ装置110Bによって行われ、その処理結果が応答通知として、エッジルータ装置110Bからネットワーク管理装置130に通知される。各エッジルータ装置110における、サーバ側エッジルータ装置110Bとしての処理(SA14~SA18)に関しては後述する。

【0065】次いで、ネットワーク管理装置130の主制御部501は、ポリシー設定要求の転送先のエッジルータ

装置110から応答通知を受信したか否かを監視し(SB6)、応答通知を受信したときはこれを受け取る(SB7)。さらに、主制御部501は、この応答通知に対応するポリシー設定要求の送信元のエッジルータ装置110に上記応答通知を転送する(SB8)。これにより、サーバ側のエッジルータ装置110Bによって行われたパケット優先度の変更処理結果が、応答通知としてクライアント側のエッジルータ装置110Aに転送され、エッジルータ装置110Aでは上記SA10の処理が行われる。

【0066】また、上記SB4の判定の結果、上記抽出した送信元アドレスを収容するエッジルータ装置110が存在しないときは、ネットワーク管理装置130は、エラー処理を行う(SB9)。このエラー処理では、ポリシー設定要求を拒絶する旨を応答通知として、この応答通知をポリシー設定要求の送信元のエッジルータ装置110に送信する。

【0067】一方、ネットワーク管理装置130からポリシー設定要求を受信したエッジルータ装置110では、即ち、上記サーバ側のエッジルータ装置110Bでは、以下の処理が行われる。

【0068】エッジルータ装置110は、ユーザ端末12からのポリシー設定要求を受信したか否かを監視する(SA1)と共に、ネットワーク管理装置130からポリシー設定要求を受信したか否かを監視しており(SA14)、主制御部407はネットワーク管理装置130からポリシー設定要求を受信したときにこれを受け取る(SA15)。

【0069】次いで、主制御部407は、変更命令と共にポリシー設定要求の内容をポリシー制御部402に送る。

【0070】変更命令と共にポリシー設定要求の内容を受け取ったポリシー制御部402は、ポリシー設定要求の内容に基づいてポリシーテーブル403の内容を変更する、或いはポリシー設定要求の内容をポリシーテーブル403に追加することによって、上記送信元アドレスで特定されるユーザ端末12から上記送信先アドレス(要求元アドレス)へ向けて送信されるパケットの優先度を変更し、設定完了を主制御部407に通知する(SA16)。その後、主制御部407は、上記ポリシー設定要求のアドレス情報(送信元アドレス、送信元ポート番号、送信先アドレス、送信先ポート番号、プロトコル種別)で指定されるパケットを課金対象外にするように課金テーブル405の内容を変更する(SA17)。これにより、クライアント側ユーザ端末12Aの管理者がサーバ側ユーザ端末12Bから送信されるパケットの優先度を変更して高速転送できるようにしたときには、この高優先度パケットに対しては、サーバ側ユーザ端末12Bが接続されたエッジルータ装置110Bのパケット課金部404で課金されることがなく、サーバ側ユーザ端末12Bの管理者に請求されることがない。このパケットに対する料金は、自動的にクライアント側ユーザ端末12Aの管理者に請求

されることになる。

【0071】この後、主制御部407は、ポリシーテーブル403及び課金テーブル405の設定が完了したことを表す設定完了通知（応答通知）をネットワーク制御装置130に送信する（SA18）。

【0072】一方、上記手順で設定した内容を解除するには、上記手順と同様の手順でクライアント側ユーザ端末12Aが接続されたエッジルータ装置110Aのポリシーテーブル403と課金テーブル405、及びサーバ側ユーザ端末12Bが接続されたエッジルータ装置110Bのポリシーテーブル403と課金テーブル405を変更して、設定を元に戻せば良い。

【0073】前述したように、上記実施形態によれば、エッジルータ装置110とコアルータ装置120で構成されるパケット通信網11において、クライアント側ユーザ端末12Aがサーバ側ユーザ端末12Bからのパケットの優先度を、サーバ側ユーザ端末12Bの管理者がまったく関知せずに、クライアント側ユーザ端末12Aの管理者の自由に変更することができる。さらに、クライアント側ユーザ端末12Aの管理者がサーバ側ユーザ端末12Bから自己端末12Aに向けて送信されるパケットの優先度を変更した時のパケット課金は、クライアント側のエッジルータ装置110Aで処理され、クライアント側ユーザ端末12Aの管理者に料金請求が行われ、サーバ側ユーザ端末12Bの管理者には課金されない。そのため、悪意な設定でサーバ側ユーザ端末12Bの管理者が知らない間にサーバ側に課金される心配がない。従って、本実施形態では、パケット通信網11の提供者がポリシー制御と課金処理を行うので、パケット通信網11の利用者すなわちクライアント側ユーザ端末12Aの管理者とサーバ側ユーザ端末12Bの管理者及びその他のユーザ端末12の管理者が課金処理に関して特別な処理を行う必要はない。

【0074】また、上記のコンピュータプログラムが記録されているコンピュータ読み取り可能な情報記録媒体を作成することにより、上記コンピュータプログラムを容易に配布することができる。また、通信網を介して上記コンピュータプログラムを配布してもよいことは言うまでもない。

【0075】尚、上記図1は、サーバ側ユーザ端末12Bがネットワーク管理装置130によって管理されるエッジルータ装置110Bに接続された構成になっているが、図8に示すように、エッジルータ装置110Bにアクセス線路13Bを介して接続されたグローバルネットワーク610にサーバ側ユーザ端末12Bが接続されている場合においても本発明は有効である。サーバ側エッジルータ装置110Bがグローバルネットワーク610を介したサーバ側ユーザ端末12Bからのパケットのヘッダ部を見て処理すれば、図1の構成と同様の処理が可能である。ただし、図8の構成においては、グローバルネットワーク610内に関してはサーバ側ユーザ端末12Bからのパケットの優先度を変更す

ることはできない。

【0076】

【発明の効果】以上説明したように本発明によれば、ユーザ端末からポリシー設定要求を送信することにより、このユーザ端末から特定の送信先アドレスのユーザ端末に送信されるパケットの優先度を変更することができると共に、特定の送信元アドレスのユーザ端末から自己ユーザ端末に送信されるパケットの優先度を変更することができるため、例えば、クライアント側のユーザ端末がサーバ側のユーザ端末に要求を送信してサーバ側ユーザ端末から情報を入手するクライアント・サーバ形式の場合、サーバ側ユーザ端末の管理者に対して連絡をしなくても、サーバ側ユーザ端末の送信パケットの優先度をクライアント側ユーザ端末の管理者が変更することができるので、サーバ側ユーザ端末が保持している音楽や映像等のストリーム型のデータをクライアント側ユーザ端末がダウンロードするときに、高速なダウンロードを簡単な操作で可能にすることができる。

【0077】また、ユーザ端末から受信したポリシー設定要求のパケットのヘッダ部の内容から、このポリシー設定要求を送信したユーザ端末のアドレスを抽出することにより、ポリシー設定要求を送信したユーザ端末のアドレスを容易に且つ確実に抽出することができる。

【0078】さらに、前記エッジルータ装置において課金処理が行われる場合に、上記ポリシー設定要求によって生じた課金対象となる高優先度通信パケットに対する課金が、上記ポリシー設定要求を送信したユーザ端末の管理者に対して自動的に課せられるようにしたので、上記のようなクライアント・サーバ形式の場合においてもサーバ側ユーザ端末の管理者に課金の付け替えのための複雑な処理の負担をかけることがない。

【0079】さらにまた、クライアント側ユーザ端末内のアプリケーションの中にサーバとして情報を提供するアプリケーションが混在している場合や、そのサーバがフリーソフトを配布するような決済手段を持っていない場合にも、パケット優先度変更に伴う面倒な課金の付け替えのための複雑な処理を行う必要がないため、個人レベルで立ち上げたサーバとしてのユーザ端末の管理者が複雑な取引システムをサポートする必要がないので、大衆のネットワーク参加を阻害する要因を低減することができ、ネットワーク通信の普及と向上を図ることができる。

【図面の簡単な説明】

【図1】本発明の一実施形態におけるパケット通信網及びネットワーク管理システムを示す構成図

【図2】本発明の一実施形態におけるエッジルータ装置を示す構成図

【図3】本発明の一実施形態におけるユーザ要求処理部を示す構成図

【図4】本発明の一実施形態におけるネットワーク管理

装置を示す構成図

【図5】本発明の一実施形態におけるエッジルータ装置の本発明に係る処理の流れを示すフローチャート

【図6】本発明の一実施形態におけるエッジルータ装置の本発明に係る処理の流れを示すフローチャート

【図7】本発明の一実施形態におけるネットワーク管理装置の本発明に係る処理の流れを示すフローチャート

【図8】本発明の一実施形態における他の例のネットワーク通信網及びネットワーク管理システムを示す構成図

【図9】従来例のDiff-servベースネットワーク通信網の構成を示す図

【図10】従来例のエッジルータ装置の構成を示す図

【符号の説明】

1 1…パケット通信網、1 2 (12A, 12B, 12C)…ユーザ端末、1 3 (13A, 13B, 13C)…アクセス線路、110(110A, 110B, 110C)…エッジルータ装置、120…コアルータ装置、130…ネットワーク管理装置、141…パケット通信線、142…制御通信網、401…ユーザ要求処理部、402…ポリシー制御部、403…ポリシーテーブル、404…パケット課金部、405…課金テーブル、406…ルーティング制御部、407…主制御部、408…通信処理部、410…パケット通信路、411…Webサーバ、412…要求処理サーバ、501…主制御部、502…通信処理部、503…入出力部、504…記憶部、610…グローバルネットワーク。

【図1】

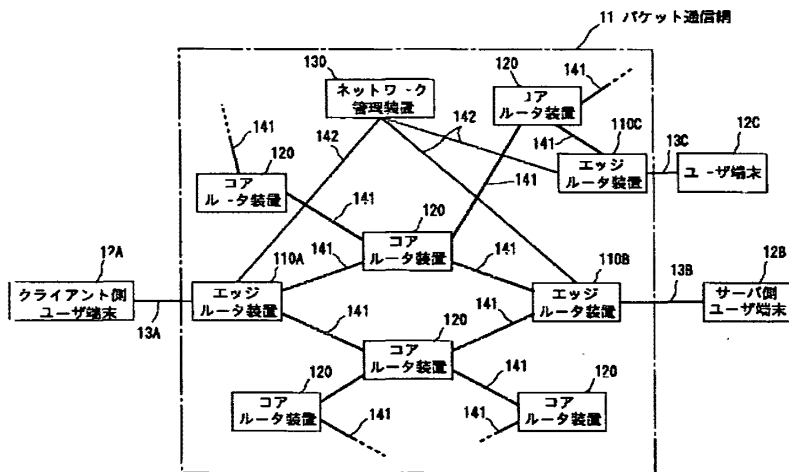

【図2】

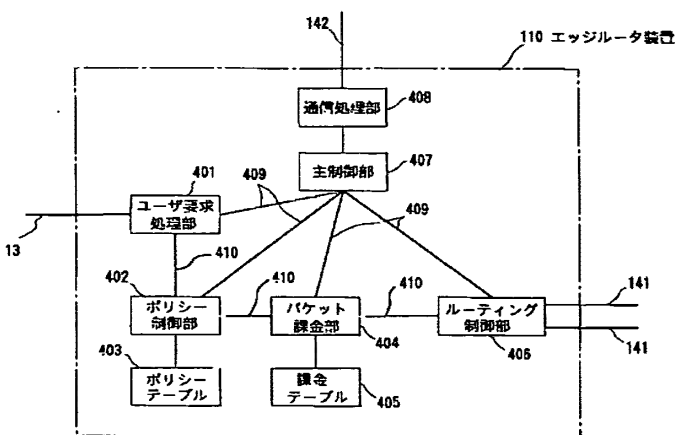

【図4】

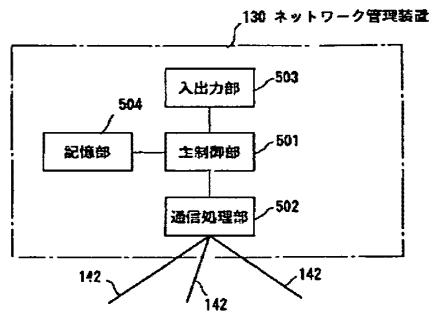

【図3】

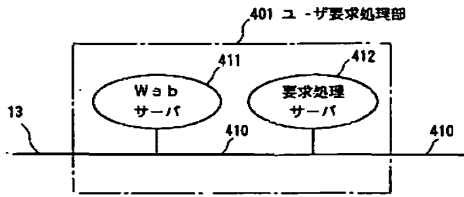

【図5】

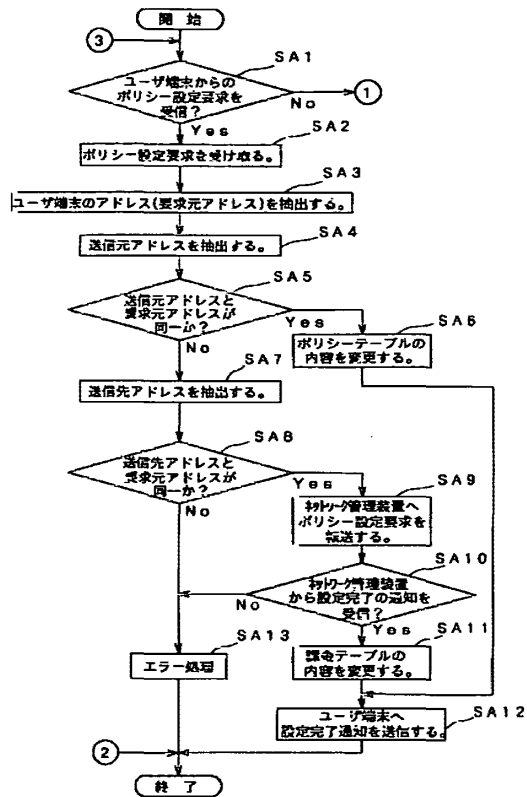

【図6】

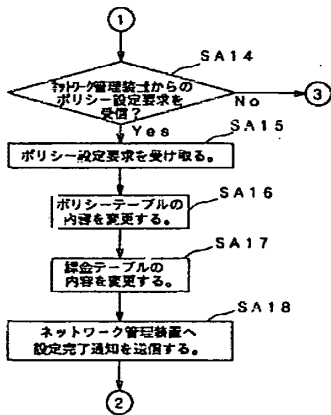

【図10】

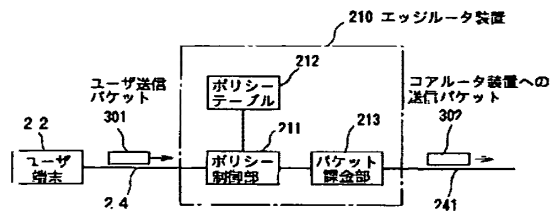

【図7】

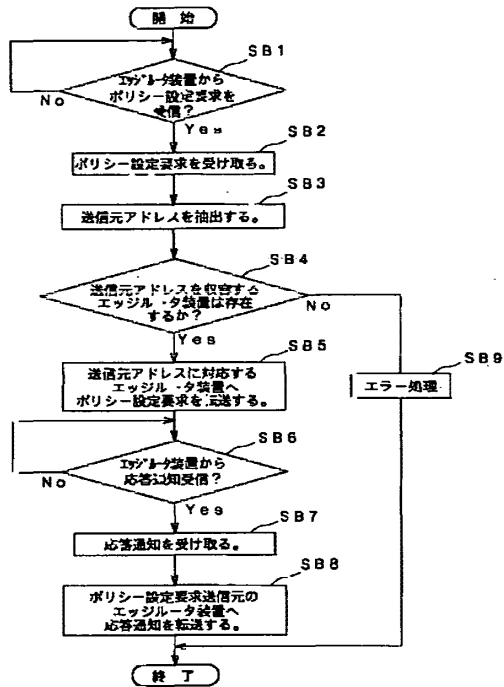

【図8】

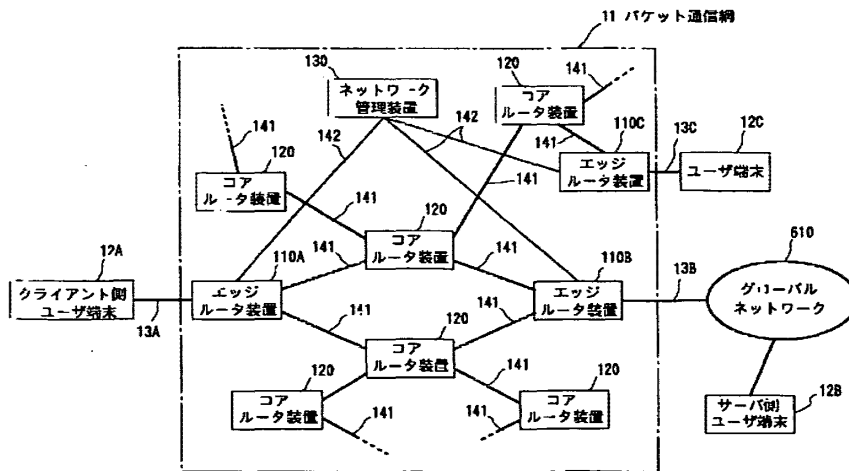

【図9】

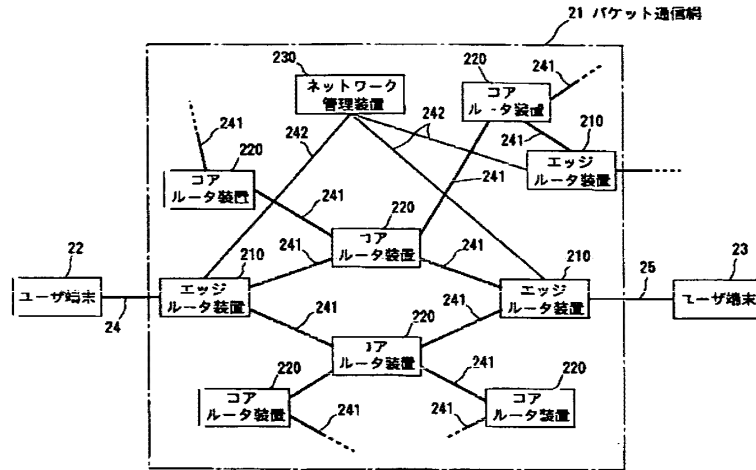

フロントページの続き

Fターム(参考) 5K030 HA08 HB08 HB17 HD03 KA01
KA05 LB05
5K033 BA08 CB17 CC01 DB18 EC04

MOBILE COMMUNICATION SERVICE CHARGING APPARATUS AND MOBILE COMMUNICATION SERVICE CHARGING METHOD

Publication number: WO02093835 (A1)

Publication date: 2002-11-21

Inventor(s): SHIRAI RYO [JP]; IITAKA TAKESHI [JP]; OGURO MASAMI [JP]; NAKANISHI MASAYUKI [JP]; KIKKAWA MIHO [JP]

Applicant(s): NTT DOCOMO INC [JP]; SHIRAI RYO [JP]; IITAKA TAKESHI [JP]; OGURO MASAMI [JP]; NAKANISHI MASAYUKI [JP]; KIKKAWA MIHO [JP]

Classification:

- international: G06Q20/00; H04L12/14; H04L29/08; H04M15/00; H04M15/28; H04M15/30; G06Q20/00; H04L12/14; H04L29/08; H04M15/00; H04M15/28; (IPC1-7): H04L12/14; H04L12/56; H04M11/08; H04M15/00

- European: H04L29/08N1; G06Q20/00K3D; H04L12/14; H04M15/00; H04M15/28; H04M15/30

Application number: WO2002JP04615 20020513

Priority number(s): JP20010143665 20010514

Also published as:

EP1296481 (A1)
 EP1296481 (A4)
 US2003153333 (A1)
 CN1462521 (A)
 CN1206833 (C)

Cited documents:

EP1026853 (A1)
 JP11066182 (A)
 JP11074882 (A)
 XP002953589 (A)
 XP002953590 (A)

more >>

Abstract of WO 02093835 (A1)

A mobile communication service charging apparatus (100) comprises delivery originator extracting means for extracting a delivery originator of information transmitted and received between a content delivery apparatus (200) and a mobile terminal (400) when a content is delivered from the content delivery apparatus (200) via a cellular telephone network (300) to the mobile terminal (400), charging rule setting means for setting a charging rule in accordance with the delivery originator of the information and/or the content of the information, and charging means for calculating a communication fee for delivery of the content in accordance with the charging rule.

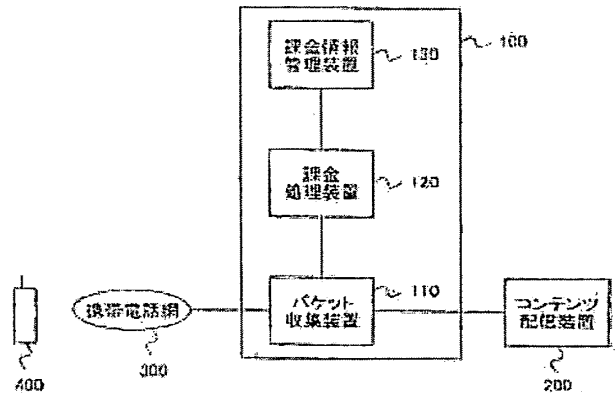

100...CHARGING INFORMATION MANAGEMENT APPARATUS
 110...PACKET COLLECTION APPARATUS
 120...CHARGING APPARATUS
 130...CHARGING INFORMATION MANAGEMENT APPARATUS
 200...CONTENT DELIVERY APPARATUS
 300...CELLULAR TELEPHONE NETWORK
 400...MOBILE TERMINAL

Data supplied from the esp@cenet database — Worldwide

(12)特許協力条約に基づいて公開された国際出願

(19) 世界知的所有権機関
国際事務局



(43) 国際公開日
2002年11月21日 (21.11.2002)

PCT

(10) 国際公開番号
WO 02/093835 A1

- (51) 国際特許分類: H04L 12/14, [JP/JP]; 〒100-6150 東京都千代田区永田町二丁目11番1号 Tokyo (JP).
12/56, H04M 15/00, 11/08
- (21) 国際出願番号: PCT/JP02/04615 (72) 発明者; および (75) 発明者/出願人 (米国についてのみ): 白井 亮 (SHIRAI, Ryo) [JP/JP]; 〒100-6150 東京都千代田区永田町2丁目11番1号山王パークタワー株式会社エヌ・ティ・ティ・ドコモ知的財産部内 Tokyo (JP). 飯高 剛士 (IITAKA, Takeshi) [JP/JP]; 〒100-6150 東京都千代田区永田町2丁目11番1号山王パークタワー株式会社エヌ・ティ・ティ・ドコモ知的財産部内 Tokyo (JP). 小黒 雅己 (OGURO, Masami) [JP/JP]; 〒100-6150 東京都千代田区永田町2丁目11番1号山王パークタワー株式会社エヌ・ティ・ティ・ドコモ知的財産部内 Tokyo (JP). 中西 雅之 (NAKANISHI, Masayuki) [JP/JP]; 〒100-6150 東京都千代田区永田町2丁目11番1号
- (22) 国際出願日: 2002年5月13日 (13.05.2002)
- (25) 国際出願の言語: 日本語
- (26) 国際公開の言語: 日本語
- (30) 優先権データ: 特願2001-143665 2001年5月14日 (14.05.2001) JP
- (71) 出願人 (米を除く全ての指定国について): 株式会社エヌ・ティ・ティ・ドコモ (NTT DOCOMO, INC.)

[続葉有]

(54) Title: MOBILE COMMUNICATION SERVICE CHARGING APPARATUS AND MOBILE COMMUNICATION SERVICE CHARGING METHOD

(54) 発明の名称: 移動通信サービス課金装置及び移動通信サービス課金方法

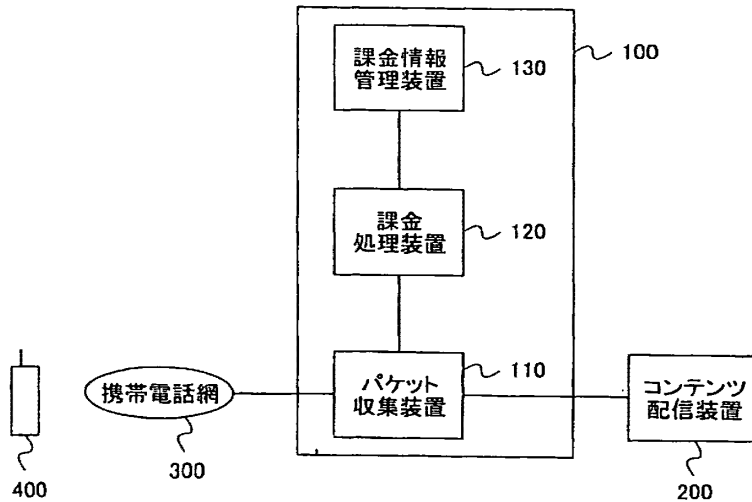

(57) Abstract: A mobile communication service charging apparatus (100) comprises delivery originator extracting means for extracting a delivery originator of information transmitted and received between a content delivery apparatus (200) and a mobile terminal (400) when a content is delivered from the content delivery apparatus (200) via a cellular telephone network (300) to the mobile terminal (400), charging rule setting means for setting a charging rule in accordance with the delivery originator of the information and/or the content of the information, and charging means for calculating a communication fee for delivery of the content in accordance with the charging rule.

- 130...CHARGING INFORMATION MANAGEMENT APPARATUS
120...CHARGING APPARATUS
110...PACKET COLLECTION APPARATUS
300...CELLULAR TELEPHONE NETWORK
200...CONTENT DELIVERY APPARATUS

[続葉有]

WO 02/093835 A1



山王パークタワー株式会社エヌ・ティ・ティ・ドコモ知的財産部内 Tokyo (JP). 吉川 実穂 (KIKKAWA, Miho) [JP/JP]; 〒100-6150 東京都千代田区永田町2丁目11番1号山王パークタワー株式会社エヌ・ティ・ティ・ドコモ知的財産部内 Tokyo (JP).

(84) 指定国 (広域): ヨーロッパ特許 (AT, BE, CH, CY, DE, DK, ES, FI, FR, GB, GR, IE, IT, LU, MC, NL, PT, SE, TR).

添付公開書類:
— 国際調査報告書

(74) 代理人: 伊東 忠彦 (ITO, Tadahiko); 〒150-6032 東京都渋谷区恵比寿4丁目20番3号恵比寿ガーデンプレイスタワー32階 Tokyo (JP).

2文字コード及び他の略語については、定期発行される各PCTガゼットの巻頭に掲載されている「コードと略語のガイダンスノート」を参照。

(81) 指定国 (国内): CN, JP, KR, SG, US.

(57) 要約:

コンテンツ配信装置 (200) から携帯電話網 (300) を介して移動端末 (400) へのコンテンツの配信に際し、前記コンテンツ配信装置 (200) と前記移動端末 (400) との間で送受される情報の配信元を抽出する配信元抽出手段と、前記情報の配信元及び/または前記情報の内容に基づいて課金ルールを設定する課金ルール設定手段と、前記課金ルールに基づいて前記コンテンツの配信に対する通信料金を計算する課金手段と、を備える移動通信サービス課金装置 (100)。

明 細 書

移動通信サービス課金装置及び移動通信サービス課金方法

5 技術分野

本発明は、各種の移動通信サービスにおける通信料金を計算する移動通信サービス課金装置及び移動通信サービス課金方法に関する。

背景技術

- 10 近年、移動通信においては、移動端末に対しインターネット上のコンテンツ等様々なコンテンツを配信するサービスが行われている。このようなコンテンツ配信サービスでは、コンテンツ配信に際し、コンテンツ配信装置から移動端末へ送信されるパケットのパケット量や移動端末からコンテンツ配信装置へ送信されるパケットのパケット量を測定し、このパケット量に応じた通信料金が計算される
- 15 。

- しかしながら、上述した従来のコンテンツ配信サービスでは、通信料金はパケット量に応じて決定されており、配信されるコンテンツに応じた通信料金を計算することができなかった。例えば、従来のコンテンツ配信サービスでは、利用価値の高いコンテンツの配信に際しては通信料金を高くし、利用価値の低いコンテンツの配信に際しての通信料金を低くする等、柔軟に通信料金を設定することができなかった。このため、今後の移動通信において柔軟な通信料金の設定を可能とすべく、新たな課金方法が要求されている。
- 20

発明の開示

- 25 本発明は、上記問題点を解決するものであり、その目的は、通信料金を柔軟に設定することが可能な移動通信サービス課金装置及び移動通信サービス課金方法を提供することにある。

上記の目的を達成するため、本発明の移動通信サービス課金装置は、コンテンツ配信装置から移動端末へのコンテンツの配信に際し、前記コンテンツ配信装置

と前記移動端末との間で送受される情報の配信元を抽出する配信元抽出手段と、前記配信元情報抽出手段により抽出された配信元情報及び又は前記情報の内容に基づいて課金ルールを設定する課金ルール設定手段と、前記課金ルール設定手段により設定された課金ルールに基づいて、前記コンテンツの配信に対する通信料

5 金を計算する課金手段とを備える。

このような移動通信サービス課金装置では、配信されるコンテンツ毎に、その内容に応じた課金ルールが設定され、その課金ルールに従ってコンテンツ配信に対する通信料金が計算されるため、通信料金を柔軟に設定することが可能となる。

10 また、本発明の移動通信サービス課金装置は、前記課金ルールを登録する課金ルール登録手段を備え、前記課金ルール設定手段は、前記課金ルール登録手段により登録された課金ルールの中から、前記情報の内容に基づいて課金ルールを設定するようにした。

また、本発明の移動通信サービス課金装置は、前記配信元抽出手段が前記コン

15 テンツ配信装置から前記移動端末へ配信されるコンテンツとともに送信される当該コンテンツの配信元情報を抽出するようにした。

配信元情報がインターネット上のコンテンツの所在位置を示すURL (Uniform Resource Locator) 等のコンテンツと1対1に対応する情報である場合には、このように、配信元情報に基づいて課金ルールを設定することにより、配信され

20 るコンテンツ毎に課金ルールが設定されるため、通信料金を柔軟に設定することが可能となる。

同様の観点から、本発明の移動通信サービス課金装置は、前記配信元抽出手段が前記移動端末から前記コンテンツ配信装置へ送信されるコンテンツ配信要求に含まれる配信元情報を抽出するようにした。

25 また、本発明の移動通信サービス課金装置は、前記コンテンツ配信装置から前記移動端末へ配信されるコンテンツとともに送信される課金ルールを抽出する課金ルール抽出手段を備え、前記課金ルール設定手段が前記課金ルール抽出手段により抽出された課金ルールを設定するようにした。

この場合には、コンテンツとともに送信される課金ルールに従って、通信料金

が計算されるため、コンテンツ提供者が課金ルールを変更した場合、その変更を直ちに反映することが可能となる。

また、本発明の移動通信サービス課金装置は、前記配信元抽出手段が前記移動端末から前記コンテンツ配信装置へ送信されるコンテンツ配信要求に含まれる配信元情報を抽出し、前記課金ルール設定手段が前記抽出された配信元情報に対応するコンテンツ配信装置から送信される課金ルールを、前記情報の内容に応じた課金ルールとして設定するようにした。

配信元情報がコンテンツと1対1に対応する情報である場合には、このように、配信元情報に基づいて課金ルールを設定することにより、配信されるコンテンツ毎に課金ルールが設定されるため、通信料金を柔軟に設定することが可能となる。

また、本発明の移動通信サービス課金装置は、前記コンテンツ配信装置と前記移動端末との間で送受される情報の情報量を測定する情報量測定手段を備え、前記課金手段が前記課金ルール設定手段により設定された課金ルールに基づいて、前記情報量測定手段により測定された情報量に応じた通信料金を計算するようにした。

また、本発明の移動通信サービス課金方法は、コンテンツ配信装置から移動端末へのコンテンツの配信に際し、前記コンテンツ配信装置と前記移動端末との間で送受される情報の配信元を抽出し、前記抽出した配信元情報及び又は前記情報の内容に基づいて課金ルールを設定し、前記設定した課金ルールに基づいて、前記コンテンツの配信に対する通信料金を計算するようにした。

また、本発明の移動通信サービス課金方法は、前記課金ルールを登録し、前記登録した課金ルールの中から、前記情報の内容に基づいて課金ルールを設定するようにした。

また、本発明の移動通信サービス課金方法は、前記コンテンツ配信装置から前記移動端末へ配信されるコンテンツとともに送信される当該コンテンツの配信元情報を抽出するようにした。

また、本発明の移動通信サービス課金方法は、前記移動端末から前記コンテンツ配信装置へ送信されるコンテンツ配信要求に含まれる配信元情報を抽出するよ

うにした。

また、本発明の移動通信サービス課金方法は、前記コンテンツ配信装置から前記移動端末へ配信されるコンテンツとともに送信される課金ルールを抽出し、前記抽出された課金ルールを設定するようにした。

- 5 また、本発明の移動通信サービス課金方法は、前記移動端末から前記コンテンツ配信装置へ送信されるコンテンツ配信要求に含まれる配信元情報を抽出し、前記抽出した配信元情報に対応するコンテンツ配信装置から送信される課金ルールを、前記情報の内容に応じた課金ルールとして設定するようにした。

- 10 また、本発明の移動通信サービス課金方法は、前記コンテンツ配信装置と前記移動端末との間で送受される情報の情報量を測定し、前記設定した課金ルールに基づいて、前記測定した情報量に応じた通信料金を計算するようにした。

なお、本発明の他の目的、特徴、利点は、添付図面と共になされる以下の詳細な説明にて、明らかにされる。

15 図面の簡単な説明

図1は、移動通信サービス課金装置の構成例を示す図である。

図2は、パケット収集装置の構成例を示す図である。

図3は、課金ルールの一例を示す図である。

- 20 図4は、第1実施例における移動通信サービス課金装置の動作を示すシーケンス図である。

図5は、第2実施例における移動通信サービス課金装置の動作を示すシーケンス図である。

発明を実施するための最良の形態

- 25 以下、本発明の実施の形態を図面に基づいて、説明する。図1は、本発明の実施の形態に係る移動通信サービス課金装置の構成例を示す図である。

同図に示す移動通信サービス課金装置100は、コンテンツ配信装置200の所有者（コンテンツ提供者）によって事前に登録されたコンテンツ毎の課金ルール、又はコンテンツ配信装置200からコンテンツとともに送信される課金ルー

ルに基づいて、当該コンテンツ配信装置 200 と移動端末としての携帯電話機 400 との間で送受される情報の情報量に応じた通信料金を計算する。

移動通信サービス課金装置 100 は、コンテンツ配信装置 200 と接続され、携帯電話網 300 を介して携帯電話機 400 と接続される。また、この移動通信
5 サービス課金装置 100 は、パケット収集装置 110、課金処理装置 120、課金情報管理装置 130 を備えて構成される。

パケット収集装置 110 は、コンテンツ配信装置 200 から携帯電話機 400
へのコンテンツの配信に際し、コンテンツ配信装置 200 から携帯電話機 400
へ送信される TCP (Transmission Control Protocol) パケットと、携帯電話
10 機 400 からコンテンツ配信装置 200 へ送信される TCP パケットを受信する
。

パケット収集装置 110 は、これら受信した TCP パケットのヘッダに含まれ
る送受信アドレス及び送受信ポート番号を解析し、同一の送受信アドレス及び送
受信ポート番号を含む TCP パケットをまとめて HTTP (Hyper Text Transfe
15 r Protocol) データを復元する。

携帯電話機 400 からコンテンツ配信装置 200 へ送信される TCP パケット
から復元される HTTP データは、携帯電話機 400 からコンテンツ配信装置 2
00 へのコンテンツ配信要求である HTTP リクエストである。一方、コンテン
ツ配信装置 200 から携帯電話機 400 へ送信される TCP パケットから復元さ
20 れる HTTP データは、上述した HTTP リクエストに対するコンテンツ配信装
置 200 の応答である HTTP レスポンスである。なお、この HTTP レスポン
スには、配信されるコンテンツのデータが含まれる。

パケット収集装置 110 は、図 2 に示すように、データ量を測定するデータ量
測定部 112 と、URL (Uniform Resource Locator) を抽出する HTTP ヘッ
25 ダ抽出部 114 と、課金処理装置との情報の送受信を行う送受信部 116 とを備
える。このパケット収集装置 110 は、復元した HTTP リクエストや HTTP
レスポンスのデータ量を測定し、その測定結果を課金処理装置 120 へ送信す
る。また、パケット収集装置 110 は、これら復元した HTTP リクエストヘッダ
からコンテンツ配信装置 200 内のコンテンツの所在位置を示す URL (Unifor

m Resource Locator) を抽出する。この抽出されたコンテンツの所在位置としてのURLは、コンテンツと1対1に対応する。パケット収集装置110は、抽出したURLを、上述したHTTPリクエストやHTTPレスポンスのデータ量の測定結果とともに、課金処理装置120へ送信する。

5 また、コンテンツ配信装置200からコンテンツとともに課金ルールが送信される場合には、パケット収集装置110は、更に復元したHTTPレスポンスのヘッダから課金ルールを抽出し、この抽出した課金ルールを、当該HTTPレスポンスのデータ量の測定結果及びHTTPリクエストヘッダから抽出したURLとともに、課金処理装置120へ送信する。

10 課金処理装置120は、パケット収集装置110から送信されるURLを受信すると、携帯電話機400が要求し、当該要求に応じてコンテンツ配信装置200から配信されるコンテンツに対応する課金ルールを設定する。

 具体的には、コンテンツ提供者により課金ルールが事前に登録されている場合には、課金処理装置120は、パケット処理装置110から受信したURLを課
15 金情報管理装置130へ送信し、課金ルールを問い合わせる。

 課金情報管理装置130は、コンテンツ提供者により事前に登録された課金ルールと、当該課金ルールに対応するコンテンツの所在位置のURLとが対応付けられた課金ルールデータベース（図示せず）を所有している。課金情報管理装置
20 130は、課金処理装置120からのURLを受信すると、当該URLをキーとして課金ルールデータベースを検索し、当該URLに対応する課金ルールを取得する。

 図3は、課金ルールの一例を示す図である。同図に示す課金ルールは、携帯電話機400のユーザとコンテンツ提供者とが通信料をどのような割合で負担するかについて定めた課金ルールの一例である。課金ルールは、この他にもさまざまなものが考えられる。例えば、平日は通常の通信料であり休日は割り引いた通信料、
25 昼間は通常の通信料であり夜間は割り引いた通信料というように、時間帯で通信料が変更されるように定められた課金ルール等がある。

 課金情報管理装置130は、このようにして取得した課金ルールを課金処理装置120へ送信する。課金処理装置120は、この課金ルールを受信し、通信料

金計算に用いる課金ルールとして設定する。そして、課金処理装置120は、この設定した課金ルールに従って、当該課金ルールに対応するURLを含んだHTTPリクエストやHTTPレスポンスのデータ量に応じた通信料金計算を行う。

一方、コンテンツ配信装置200からコンテンツとともに課金ルールが送信される場合には、課金処理装置120は、パケット収集装置110から送信される課金ルールを受信する。

次に、課金処理装置120は、この受信した課金ルールを通信料金計算に用いる課金ルールとして設定する。そして、課金処理装置120は、この設定した課金ルールに従って、当該課金ルールをヘッダに含んだHTTPレスポンスのデータ量に応じた通信料金計算を行うとともに、当該HTTPレスポンスに対応するHTTPリクエストのデータ量に応じた通信料金計算を行う。

なお、HTTPレスポンスに対応するHTTPリクエストは、パケット収集装置110により判断され、課金処理装置120に通知される。課金処理装置120は、HTTPリクエストヘッダ内のURLと、パケット収集装置110から通知された、対応するHTTPレスポンスヘッダ内の課金ルールを、当該HTTP通信のデータ量に応じた通信料金計算に用いる課金ルールとして、通信料金の計算を行う。

次に、シーケンス図を用いて、コンテンツ提供者によってコンテンツ毎の課金ルールが事前に登録される第1実施例における移動通信サービス課金装置100の動作と、コンテンツ配信装置200からコンテンツとともに課金ルールが送信される第2実施例における移動通信サービス課金装置100の動作とを説明する。

図4は、第1実施例における移動通信サービス課金装置100の動作を示すシーケンス図である。課金情報管理装置130は、コンテンツ提供装置200から送信される課金ルールのデータを受信し、この課金ルールを予め課金ルールデータベース(DB)に登録する(ステップ101)。

課金ルールが課金ルールDBに登録された後、パケット収集装置110は、コンテンツ配信装置200から携帯電話機400へのコンテンツの配信に際し、携帯電話機400から送信される、HTTPリクエストを構成するTCPパケット

を受信するとともに、これらTCPパケットをコンテンツ配信装置200へ中継する(ステップ102)。

また、パケット収集装置110は、このHTTPリクエストに応じてコンテンツ配信装置200から送信される、HTTPレスポンスを構成するTCPパケットを受信するとともに、これらTCPパケットを携帯電話機400へ中継する(ステップ103)。

パケット収集装置110は、これら受信したTCPパケットからHTTPリクエスト及びHTTPレスポンスを復元する。そして、パケット収集装置110は、これらHTTPリクエスト及びHTTPレスポンスのデータ量を測定するとともに、HTTPリクエストヘッダからURLを抽出する(ステップ104)。次にパケット収集装置110は、測定したHTTPリクエスト及びHTTPレスポンスのデータ量と、抽出したURLとを課金処理装置120へ送信する(ステップ105、106)。

課金処理装置120は、HTTPリクエスト及びHTTPレスポンスのデータ量とURLとを受信すると、URLを課金情報管理装置130へ送信し、課金ルールを問い合わせる(ステップ107)。

課金情報管理装置130は、課金処理装置120からのURLを受信すると、当該URLをキーとして課金ルールデータベースを検索し、当該URLに対応する課金ルールを取得する(ステップ108、109)。課金情報管理装置130は、このようにして取得した課金ルールを課金処理装置120へ送信する(ステップ110)。

課金処理装置120は、この課金ルールを受信すると、通信料金計算に用いる課金ルールとして設定する。そして、課金処理装置120は、この設定した課金ルールに従って、当該課金ルールに対応するURLを含んだHTTPリクエストやHTTPレスポンスのデータ量に応じた通信料金計算を行う(ステップ111)。

図5は、第2実施例における移動通信サービス課金装置100の動作を示すシーケンス図である。パケット収集装置110は、コンテンツ配信装置200から携帯電話機400へのコンテンツの配信に際し、携帯電話機400から送信され

る、HTTPリクエストを構成するTCPパケットを受信するとともに、これらTCPパケットをコンテンツ配信装置200へ中継する(ステップ201)。

また、パケット収集装置110は、このHTTPリクエストに応じてコンテンツ配信装置200から送信される、HTTPレスポンスを構成するTCPパケットを受信するとともに、これらTCPパケットを携帯電話機400へ中継する(ステップ202)。

パケット収集装置110は、これら受信したTCPパケットからHTTPリクエスト及びHTTPレスポンスを復元する。そして、パケット収集装置110は、これらHTTPリクエスト及びHTTPレスポンスのデータ量を測定する。また、パケット収集装置110は、HTTPリクエストヘッダからURLを抽出するとともに、HTTPレスポンスのヘッダから課金ルールを抽出する(ステップ203)。

次にパケット収集装置110は、測定したHTTPリクエスト及びHTTPレスポンスのデータ量と、抽出したURL及び課金ルールとを課金処理装置120へ送信する(ステップ204~206)。

課金処理装置120は、HTTPリクエスト及びHTTPレスポンスのデータ量、URL及び課金ルールを受信すると、当該受信した課金ルールを通信料金計算に用いる課金ルールとして設定する。そして、課金処理装置120は、この設定した課金ルールに従って、当該課金ルールをヘッダに含んだHTTPレスポンスのデータ量に応じた通信料金計算を行うとともに、当該HTTPレスポンスに対応するHTTPリクエストのデータ量に応じた通信料金計算を行う(ステップ207)。

このように、本実施形態の移動通信サービス課金装置100は、コンテンツ提供者からの課金ルールを予め課金ルールDBに登録しておき、コンテンツ配信装置200から携帯電話機400へのコンテンツの配信に際し、コンテンツ配信装置200と携帯電話機400との間で送受されるTCPパケットからHTTPリクエスト及びHTTPレスポンスを復元し、これらHTTPリクエスト及びHTTPレスポンスのデータ量を測定するとともに、HTTPリクエストヘッダからURLを抽出する。そして、移動通信サービス課金装置100は、抽出したUR

Lに対応する課金ルールを課金ルールDBから取得し、当該課金ルールを通信料金計算に用いる課金ルールとして設定した上で、HTTPリクエストやHTTPレスポンスのデータ量に応じた通信料金計算を行う。

また、本実施形態の移動通信サービス課金装置100は、コンテンツ配信装置
5 200から携帯電話機400へのコンテンツの配信に際し、コンテンツ配信装置
200と携帯電話機400との間で送受されるTCPパケットからHTTPリク
エスト及びHTTPレスポンスを復元し、これらHTTPリクエスト及びHTT
Pレスポンスのデータ量を測定するとともに、HTTPリクエストヘッダからU
R Lを抽出し、更にHTTPレスポンスから課金ルールを抽出する。そして、移
10 動通信サービス課金装置100は、抽出した課金ルールを通信料金計算に用いる
課金ルールとして設定した上で、HTTPリクエストやHTTPレスポンスのデ
ータ量に応じた通信料金計算を行う。

即ち、配信されるコンテンツ毎に課金ルールが設定され、その課金ルールに従
ってコンテンツ配信装置200と携帯電話機300との間で送受されるHTTP
15 リクエストやHTTPレスポンスのデータ量に応じた通信料が計算されるため、
通信料金を柔軟に設定することが可能となる。

なお、上述した実施形態では、移動通信サービス課金装置100は、HTTP
リクエストヘッダからURLを抽出し、この抽出したURLに対応する課金ル
ールを通信料金計算に用いる課金ルールとして設定したが、HTTPレスポンスに
20 含まれるコンテンツデータの拡張子を抽出して、当該拡張子に対応する課金ル
ールを設定するようにしても良い。この場合は、コンテンツデータの拡張子により
当該コンテンツの内容が識別可能であるため、上述した実施形態と同様、配信さ
れるコンテンツ毎に課金ルールを設定することが可能となる。

上述の如く、本願発明によれば、配信されるコンテンツ毎に課金ルールが設定
25 され、その課金ルールに従ってコンテンツの配信に対する通信料金が計算される
ため、通信料金を柔軟に設定することが可能となる。

請求の範囲

1. コンテンツ配信装置から移動端末へのコンテンツの配信に際し、前記コンテンツ配信装置と前記移動端末との間で送受される情報の配信元を抽出する配信元抽出手段と、
5 前記配信元情報抽出手段により抽出された配信元情報及び又は前記情報の内容に基づいて課金ルールを設定する課金ルール設定手段と、
前記課金ルール設定手段により設定された課金ルールに基づいて、前記コンテンツの配信に対する通信料金を計算する課金手段と、
10 を備える移動通信サービス課金装置。
2. 請求項1に記載の移動通信サービス課金装置において、
前記課金ルールを登録する課金ルール登録手段を備え、
前記課金ルール設定手段は、前記課金ルール登録手段により登録された課金ルールの中から、前記情報の内容に基づいて課金ルールを設定するようにした移動通信サービス課金装置。
3. 請求項1又は2に記載の移動通信サービス課金装置において、
前記配信元抽出手段は、前記コンテンツ配信装置から前記移動端末へ配信されるコンテンツとともに送信される当該コンテンツの配信元情報を抽出するようにした移動通信サービス課金装置。
4. 請求項1又は2に記載の移動通信サービス課金装置において、
前記配信元抽出手段は、前記移動端末から前記コンテンツ配信装置へ送信されるコンテンツ配信要求に含まれる配信元情報を抽出するようにした移動通信サービス課金装置。
5. 請求項1に記載の移動通信サービス課金装置において、
前記コンテンツ配信装置から前記移動端末へ配信されるコンテンツとともに送

信される課金ルールを抽出する課金ルール抽出手段を備え、

前記課金ルール設定手段は、前記課金ルール抽出手段により抽出された課金ルールを設定するようにした移動通信サービス課金装置。

- 5 6. 請求項 5 に記載の移動通信サービス課金装置において、
前記配信元抽出手段は、前記移動端末から前記コンテンツ配信装置へ送信されるコンテンツ配信要求に含まれる配信元情報を抽出し、
前記課金ルール設定手段は、前記抽出された配信元情報に対応するコンテンツ配信装置から送信される課金ルールを、前記情報の内容に応じた課金ルールとして設定するようにした移動通信サービス課金装置。
- 10 7. 請求項 1 乃至 6 の何れかに記載の移動通信サービス課金装置において、
前記コンテンツ配信装置と前記移動端末との間で送受される情報の情報量を測定する情報量測定手段を備え、
15 前記課金手段は、前記課金ルール設定手段により設定された課金ルールに基づいて、前記情報量測定手段により測定された情報量に応じた通信料金を計算するようにした移動通信サービス課金装置。
- 20 8. コンテンツ配信装置から移動端末へのコンテンツの配信に際し、前記コンテンツ配信装置と前記移動端末との間で送受される情報の配信元を抽出し、
前記抽出した配信元情報及び又は前記情報の内容に基づいて課金ルールを設定し、
前記設定した課金ルールに基づいて、前記コンテンツの配信に対する通信料金を計算するようにした移動通信サービス課金方法。
- 25 9. 請求項 8 に記載の移動通信サービス課金方法において、
前記課金ルールを登録し、
前記登録した課金ルールの中から、前記情報の内容に基づいて課金ルールを設定するようにした移動通信サービス課金方法。

10. 請求項8又は9に記載の移動通信サービス課金方法において、
前記コンテンツ配信装置から前記移動端末へ配信されるコンテンツとともに送信される当該コンテンツの配信元情報を抽出するようにした移動通信サービス課金方法。
11. 請求項8又は9に記載の移動通信サービス課金方法において、
前記移動端末から前記コンテンツ配信装置へ送信されるコンテンツ配信要求に含まれる配信元情報を抽出するようにした移動通信サービス課金方法。
12. 請求項1に記載の移動通信サービス課金方法において、
前記コンテンツ配信装置から前記移動端末へ配信されるコンテンツとともに送信される課金ルールを抽出し、
前記抽出された課金ルールを設定するようにした移動通信サービス課金方法。
13. 請求項12に記載の移動通信サービス課金方法において、
前記移動端末から前記コンテンツ配信装置へ送信されるコンテンツ配信要求に含まれる配信元情報を抽出し、
前記抽出した配信元情報に対応するコンテンツ配信装置から送信される課金ルールを、前記情報の内容に応じた課金ルールとして設定するようにした移動通信サービス課金方法。
14. 請求項8乃至13の何れかに記載の移動通信サービス課金方法において、
前記コンテンツ配信装置と前記移動端末との間で送受される情報の情報量を測定し、
前記設定した課金ルールに基づいて、前記測定した情報量に応じた通信料金を計算するようにした移動通信サービス課金方法。

FIG.1

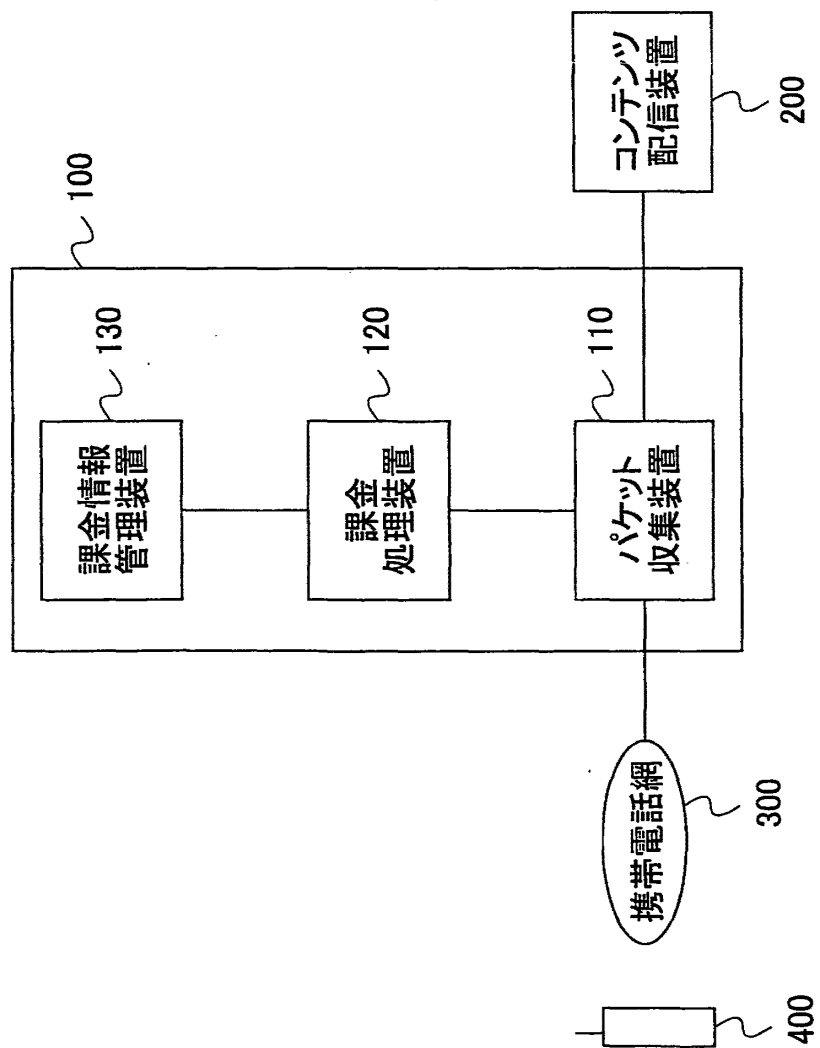

FIG.2

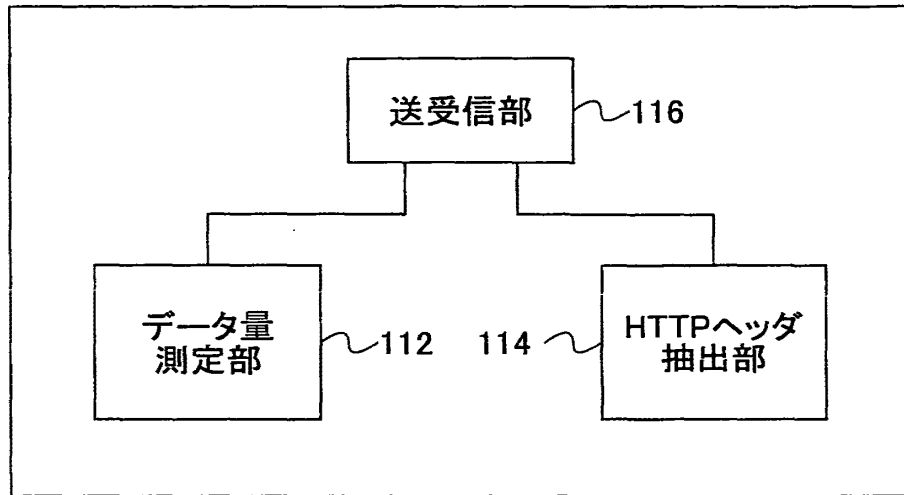

FIG.3

通信用料負担割合		サービスイメージ
ユーザ	コンテンツ提供者	
100%	0%	通常の課金
0%	100%	コンテンツ提供者負担(例: 広告)
100-N%	N%	通信用料割引
100×M%	0%	情報料追加徴収
アクセス通信用料	ダウンロード通信用料	ダウンロード料をコンテンツ提供者が負担

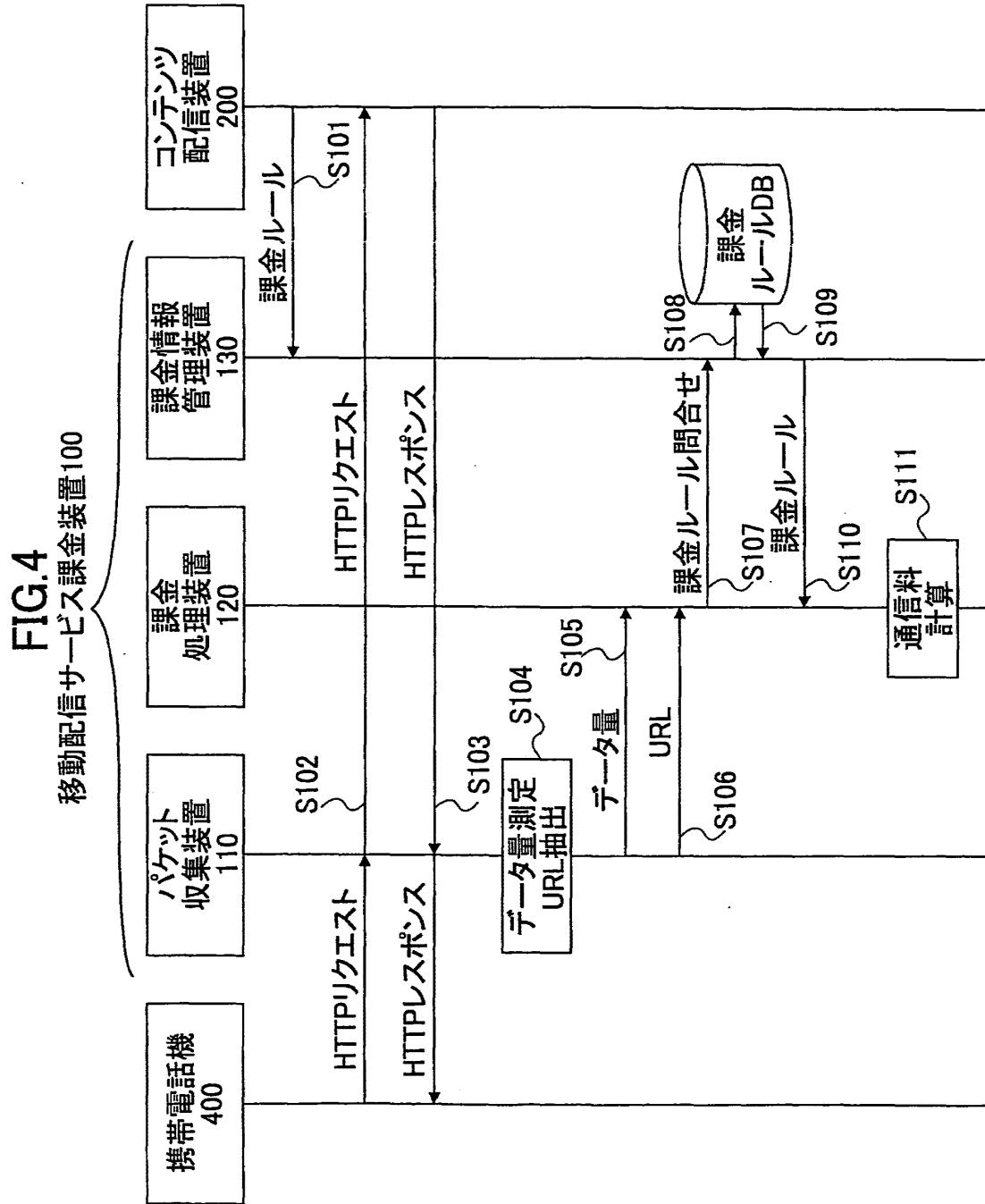
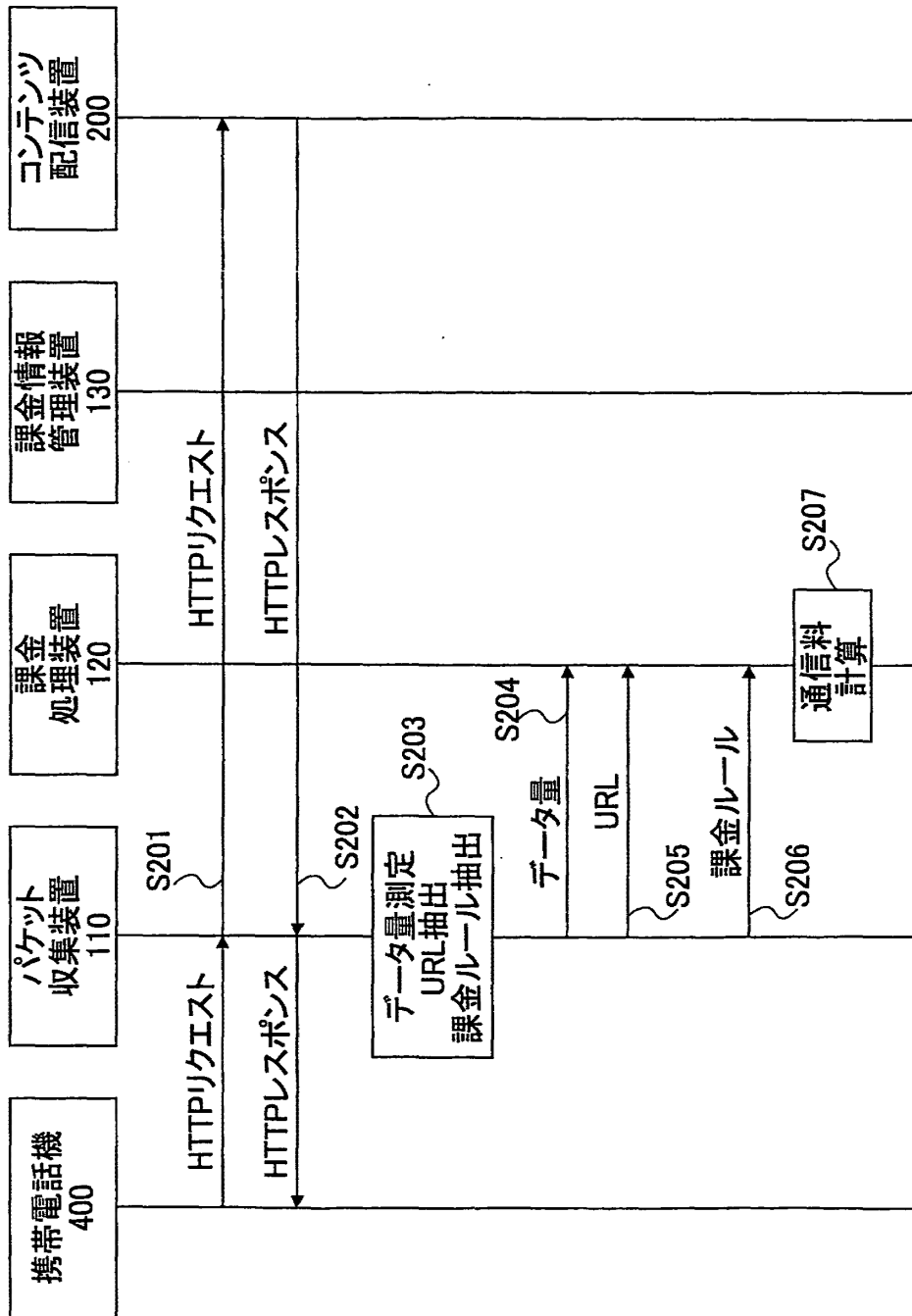

FIG.5
移動配信サービス課金装置100



INTERNATIONAL SEARCH REPORT

International application No.
PCT/JP02/04615

A. CLASSIFICATION OF SUBJECT MATTER Int.Cl ⁷ H04L12/14, H04L12/56, H04M15/00, H04M11/08 According to International Patent Classification (IPC) or to both national classification and IPC		
B. FIELDS SEARCHED Minimum documentation searched (classification system followed by classification symbols) Int.Cl ⁷ H04L12/14, H04L12/56, H04M15/00, H04M11/08 Documentation searched other than minimum documentation to the extent that such documents are included in the fields searched Electronic data base consulted during the international search (name of data base and, where practicable, search terms used)		
C. DOCUMENTS CONSIDERED TO BE RELEVANT		
Category*	Citation of document, with indication, where appropriate, of the relevant passages	Relevant to claim No.
X	EP 1026853 A1 (NTT Mobile Communications Network Inc.), 09 August, 2000 (09.08.00), Par. Nos. [0019] to [0027], [0066] to [0077], [0078] (4); Figs. 1 to 3, 8, 9 & JP 2000-78129 A (Par. Nos. [0018] to [0023], [0053] to [0062], [0066]; Figs. 1 to 3, 8, 9) & WO 00/13370 A1 & JP 3142821 B2 & JP 2001-186125 A & JP 3274455 B2 & AU 9954446 A & NO 200001761 A & BR 9906770 A & CN 1275281 A & KR 2001031466 A & TW 444462 A	1-14
<input checked="" type="checkbox"/> Further documents are listed in the continuation of Box C. <input type="checkbox"/> See patent family annex.		
* Special categories of cited documents: "A" document defining the general state of the art which is not considered to be of particular relevance "E" earlier document but published on or after the international filing date "L" document which may throw doubts on priority claim(s) or which is cited to establish the publication date of another citation or other special reason (as specified) "O" document referring to an oral disclosure, use, exhibition or other means "P" document published prior to the international filing date but later than the priority date claimed		"T" later document published after the international filing date or priority date and not in conflict with the application but cited to understand the principle or theory underlying the invention "X" document of particular relevance; the claimed invention cannot be considered novel or cannot be considered to involve an inventive step when the document is taken alone "Y" document of particular relevance; the claimed invention cannot be considered to involve an inventive step when the document is combined with one or more other such documents, such combination being obvious to a person skilled in the art "&" document member of the same patent family
Date of the actual completion of the international search 21 June, 2002 (21.06.02)		Date of mailing of the international search report 02 July, 2002 (02.07.02)
Name and mailing address of the ISA/ Japanese Patent Office Facsimile No.		Authorized officer Telephone No.

INTERNATIONAL SEARCH REPORT

International application No.

PCT/JP02/04615

C (Continuation). DOCUMENTS CONSIDERED TO BE RELEVANT		
Category*	Citation of document, with indication, where appropriate, of the relevant passages	Relevant to claim No.
Y	Yoko KIKUCHI et al., "PDC Packet Ido Tsushinmo ni okeru Kakinsaki Seigyo Hoshiki", 2000 Nen The Institute of Electronics, Information and Communication Engineers Tsushin Society Taikai Koen Ronbunshu 2, page 28, B-6-28, The Institute of Electronics, Information and Communication Engineers, 07 September, 2000 (07.09.00), full text; all drawings	1, 2, 4-9, 11-14 3, 10
A		
Y	JP 11-66182 A (NTT Data Corp.), 09 March, 1999 (09.03.99), Par. Nos. [0020] to [0027]; Figs. 1 to 3 (Family: none)	1, 2, 4-6, 8, 9, 11-13
Y	JP 11-74882 A (Net Base Inc.), 16 March, 1999 (16.03.99), Par. Nos. [0017] to [0020], [0022], [0033] to [0036]; Figs. 1, 3, 8 (Family: none)	1, 2, 4, 7-9, 11, 14
A	Mitsuaki HANAOKA et al., "i Mode Service Tokushu Network Hoshiki", NTT DoCoMo Technical Journal, Vol.7, No.2, pages 16 to 21, The Telecommunications Association, 01 July, 1999 (01.07.99), full text; all drawings	1-14
A	Toshiyasu YABE, "i Mode Service Tokushu i Mode Server", NTT DoCoMo Technical Journal, Vol.7, No.2, pages 22 to 27, The Telecommunications Association, 01 July, 1999 (01.07.99), (cited non-patent technical literature 01/008245), full text; all drawings	1-14

Form PCT/ISA/210 (continuation of second sheet) (July 1998)

A. 発明の属する分野の分類 (国際特許分類 (IPC))
 Int. Cl. ⁷ H04L 12/14, H04L 12/56, H04M 15/00, H04M 11/08

B. 調査を行った分野
 調査を行った最小限資料 (国際特許分類 (IPC))
 Int. Cl. ⁷ H04L 12/14, H04L 12/56, H04M 15/00, H04M 11/08

最小限資料以外の資料で調査を行った分野に含まれるもの

国際調査で使用した電子データベース (データベースの名称、調査に使用した用語)

C. 関連すると認められる文献

引用文献の カテゴリー*	引用文献名 及び一部の箇所が関連するときは、その関連する箇所の表示	関連する 請求の範囲の番号
X	EP 1026853 A1 (NTT MOBILE COMMUNICATIONS NETWORK INC.) 2000. 08. 09 [0019]-[0027], [0066]-[0077], [0078] (4); FIG. 1-3, 8, 9 & JP 2000-78129 A (【0018】 - 【0023】 , 【0053】 - 【0062】 , 【0066】 , 【図1】 - 【図3】 , 【図8】 , 【図9】) & WO 00/13370 A1 & JP 3142821 B2 & JP 2001-186125 A & JP 3274455 B2 & AU 9954446 A & NO 200001761 A & BR 9906770 A & CN 1275281 A & KR 2001031466 A & TW 444462 A	1-14

C欄の続きにも文献が列挙されている。 パテントファミリーに関する別紙を参照。

* 引用文献のカテゴリー	の日の後に公表された文献
「A」 特に関連のある文献ではなく、一般的技術水準を示すもの	「T」 国際出願日又は優先日後に公表された文献であって出願と矛盾するものではなく、発明の原理又は理論の理解のために引用するもの
「E」 国際出願日前の出願または特許であるが、国際出願日以後に公表されたもの	「X」 特に関連のある文献であって、当該文献のみで発明の新規性又は進歩性がないと考えられるもの
「L」 優先権主張に疑義を提起する文献又は他の文献の発行日若しくは他の特別な理由を確立するために引用する文献 (理由を付す)	「Y」 特に関連のある文献であって、当該文献と他の1以上の文献との、当業者にとって自明である組合せによって進歩性がないと考えられるもの
「O」 口頭による開示、使用、展示等に言及する文献	「&」 同一パテントファミリー文献
「P」 国際出願日前で、かつ優先権の主張の基礎となる出願	

国際調査を完了した日 21. 06. 02

国際調査報告の発送日 02.07.02

国際調査機関の名称及びあて先
 日本国特許庁 (ISA/JJP)
 郵便番号100-8915
 東京都千代田区霞が関三丁目4番3号

特許庁審査官 (権限のある職員) 5 X 9744
 間野 裕一
 電話番号 03-3581-1101 内線 3594

C (続き) 関連すると認められる文献		
引用文献の カテゴリー*	引用文献名 及び一部の箇所が関連するときは、その関連する箇所の表示	関連する 請求の範囲の番号
Y	菊田洋子他, 「PDCパケット移動通信網における課金先制御方式」, 2000年電子情報通信学会通信ソサイエティ大会講演論文集2, 第28頁, B-6-28, 社団法人電子情報通信学会, 2000. 09. 07 全文, 全図	1, 2, 4-9, 11-14
A		3, 10
Y	JP 11-66182 A (株式会社エヌ・ティ・ティ・データ) 1999. 03. 09 【0020】 - 【0027】 , 【図1】 - 【図3】 (ファミリーなし)	1, 2, 4-6, 8, 9, 11-13
Y	JP 11-74882 A (有限会社ネットベース) 1999. 03. 16 【0017】 - 【0020】 , 【0022】 , 【0033】 - 【0036】 , 【図1】 , 【図3】 , 【図8】 (ファミリーなし)	1, 2, 4, 7-9, 11, 14
A	花岡光昭他, 「iモードサービス特集 ネットワーク方式」, NTT DoCoMo テクニカル・ジャーナル, 第7巻, 第2号, 第16-21頁, 社団法人電気通信協会, 1999. 07. 01 全文, 全図	1-14
A	矢部俊康, 「iモードサービス特集 iモードサーバ」, NTT DoCoMo テクニカル・ジャーナル, 第7巻, 第2号, 第22-27頁, 社団法人電気通信協会, 1999. 07. 01 (引用非特許01/008245) 全文, 全図	1-14



107W

PATENT
30952/42236

**IN THE UNITED STATES PATENT
AND TRADEMARK OFFICE**

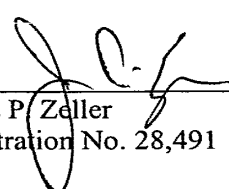
Applicant: Xiaoqin Duan)	I hereby certify that this paper is being
)	deposited with the United States Postal
Serial No.: 11/502,921)	Service, first class postage prepaid, addressed
)	to: MS Amendment, Commissioner for
Based on PCT/CN2005/000388, filed)	Patents, P.O. Box 1450, Alexandria, VA
March 28, 2005)	22313-1450 on
)	
For: METHOD FOR)	August 17, 2009
CONTROLLING CHARGING OF)	
PACKET DATA SERVICE)	
)	
Group Art Unit: 2616)	
)	James P. Zeller
Examiner: To be assigned)	Registration No. 28,491

SECOND SUPPLEMENTAL INFORMATION DISCLOSURE STATEMENT

MS Amendment
Commissioner for Patents
P.O. Box 1450
Alexandria, VA 22313-1450

Sir:

The document listed on the enclosed Form PTO-1449 is identified pursuant to 37 CFR §§1.56, 1.97, and 1.98. A copy of the document is enclosed as required.

U.S. Patent Application No. 2003/153333 is an English-language equivalent to WO 02/093835.

Entry and consideration of the submitted documents are solicited.

Respectfully submitted,

MARSHALL, GERSTEIN & BORUN LLP

August 17, 2009

By:

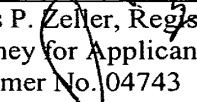

 James P. Zeller, Registration No. 28,491
 Attorney for Applicants
 Customer No. 04743
 6300 Sears Tower
 233 South Wacker Drive
 Chicago, Illinois 60606
 312-474-6300



pcw

PATENT
30952/42236

**IN THE UNITED STATES PATENT
AND TRADEMARK OFFICE**

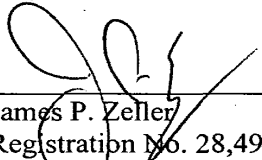
Applicant: Duan)	I hereby certify that this paper is being
)	deposited with the United States Postal
Serial No.: 11/502,921)	Service, first class postage prepaid, addressed
)	to: MS Amendment, Commissioner for
Filed: August 11, 2006)	Patents, P.O. Box 1450, Alexandria, VA
)	22313-1450 on
For: METHOD FOR)	
CONTROLLING CHARGING OF)	May 24, 2007
PACKET DATA SERVICE)	
)	
Group Art Unit: 2616)	
)	
Examiner: To be assigned)	James P. Zeller
)	Registration No. 28,491

SUPPLEMENTAL INFORMATION DISCLOSURE STATEMENT

MS Amendment
Commissioner for Patents
P.O. Box 1450
Alexandria, VA 22313-1450

Sir:

The document listed on the enclosed Form PTO-1449 is identified pursuant to 37 CFR §§1.56, 1.97, and 1.98. A copy of the document is enclosed as required.

Entry and consideration of the submitted documents are solicited.

Respectfully submitted,

MARSHALL, GERSTEIN & BORUN LLP

May 24, 2007

By:

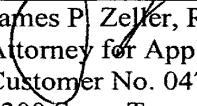

 James P. Zeller, Registration No. 28,491
 Attorney for Applicants
 Customer No. 04743
 6300 Sears Tower
 233 South Wacker Drive
 Chicago, Illinois 60606
 312-474-6300



Form PTO-1449 (Modified)	U.S. Department of Commerce Patent and Trademark Office	Atty. Docket No. 30952/42236	Serial No. 11/502,921
SUPPLEMENTAL INFORMATION DISCLOSURE STATEMENT		Applicant Duan	
		Filing Date August 11, 2006	Group 2616

U.S. PATENT DOCUMENTS							
*Examiner Initials	Document Number	Issue Date	Name	Class	Subclass	Filing Date if Appropriate	

FOREIGN PATENT DOCUMENTS							
*Examiner Initials	Document Number	Publication Date	Country	Class	Subclass	Translation	
						Yes	No

OTHER DOCUMENTS (Including Author, Title, Date, Pertinent Pages, etc.)	
	European Office Action for European Application No. 05738259.0, dated May 11, 2007.

Examiner	Date Considered
*EXAMINER: Initial if reference considered, whether or not citation is in conformance with MPEP 609; Draw line through citation if not in conformance and not considered. Include copy of this form with next communication to applicant.	



IFW

I hereby certify that this paper (along with any paper referred to as being attached
 enclosed) is being deposited with the U.S. Postal Service on the date shown
 below with sufficient postage as First Class Mail, in an envelope addressed to:
 MS Amendment, Commissioner for Patents, P.O. Box 1450, Alexandria, VA
 22313-1450.

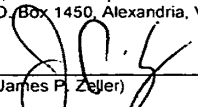
Dated: March 13, 2007 Signature: 
 (James P. Zeller)

Docket No.: 30952/42236
(PATENT)

IN THE UNITED STATES PATENT AND TRADEMARK OFFICE

In re Patent Application of:

Xiaoqin DUAN

Application No.: 11/502,921

Confirmation No.: 9151

Filed: August 11, 2006

Art Unit: 2616

For: METHOD FOR CONTROLLING
CHARGING OF PACKET DATA SERVICE

Examiner: Not Yet Assigned

**SUPPLEMENTAL
INFORMATION DISCLOSURE STATEMENT (IDS)**

MS Amendment
Commissioner for Patents
P.O. Box 1450
Alexandria, VA 22313-1450

Dear Sir:

The attached documents were cited in an Supplemental Search Report issued by the European Patent Office in counterpart European Patent Application No. 738259.0-1525 on February 22, 2007. Copies of the patents are enclosed as required.

Entry and consideration of the submitted documents are solicited.

Respectfully submitted,

MARSHALL, GERSTEIN & BORUN LLP
6300 Sears Tower
233 South Wacker Drive
Chicago, Illinois 60606
312-474-6300

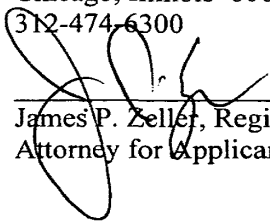
By: 
James P. Zeller, Registration No. 28,491
Attorney for Applicant

March 13, 2007

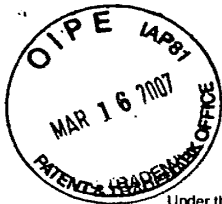

PTO/SB/08A/B (09-06)

Approved for use through 03/31/2007. OMB 0651-0031

U.S. Patent and Trademark Office; U.S. DEPARTMENT OF COMMERCE

Under the Paperwork Reduction Act of 1995, no persons are required to respond to a collection of information unless it contains a valid OMB control number.

Substitute for form 1449/PTO				Complete if Known	
INFORMATION DISCLOSURE STATEMENT BY APPLICANT <i>(Use as many sheets as necessary)</i>				Application Number	11/502,921-Conf. #9151
				Filing Date	August 11, 2006
				First Named Inventor	Xiaoqin Duan
				Art Unit	2616
				Examiner Name	Not Yet Assigned
				Attorney Docket Number	30952/42236
Sheet	1	of	1		

U.S. PATENT DOCUMENTS						
Examiner Initials*	Cite No. ¹	Document Number		Publication Date MM-DD-YYYY	Name of Patentee or Applicant of Cited Document	Pages, Columns, Lines, Where Relevant Passages or Relevant Figures Appear
		Number-Kind Code ² (if known)				
	A*	US-2003/014367		01-16-2003	Tubinis	
	B*	US-2002/152319 A1		10-17-2002	Amin	

FOREIGN PATENT DOCUMENTS							
Examiner Initials*	Cite No. ¹	Foreign Patent Document		Publication Date MM-DD-YYYY	Name of Patentee or Applicant of Cited Document	Pages, Columns, Lines, Where Relevant Passages or Relevant Figures Appear	T ⁶
		Country Code ³ -Number ⁴ -Kind Code ⁵ (if known)					
	C	WO-WO 2004/036890 A1		04-29-2004	Lialiamou et al.		<input checked="" type="checkbox"/>
	D	WO-WO 01/91446 A2		11-29-2001	Nokia Corp.		<input checked="" type="checkbox"/>

EXAMINER: Initial if reference considered, whether or not citation is in conformance with MPEP 609. Draw line through citation if not in conformance and not considered. Include copy of this form with next communication to applicant. ¹CITE NO.: Those application(s) which are marked with an asterisk () next to the Cite No. are not supplied (under 37 CFR 1.98(a)(2)(iii)) because that application was filed after June 30, 2003 or is available in the IFW. ²Applicant's unique citation designation number (optional). ³See Kinds Codes of USPTO Patent Documents at www.uspto.gov or MPEP 901.04. ⁴Enter Office that issued the document, by the two-letter code (WIPO Standard ST.3). ⁵For Japanese patent documents, the indication of the year of the reign of the Emperor must precede the serial number of the patent document. ⁶Kind of document by the appropriate symbols as indicated on the document under WIPO Standard ST.16 if possible. ⁶Applicant is to place a check mark here if English language Translation is attached.

NON PATENT LITERATURE DOCUMENTS			
Examiner Initials	Cite No. ¹	Include name of the author (in CAPITAL LETTERS), title of the article (when appropriate), title of the item (book, magazine, journal, serial, symposium, catalog, etc.), date, page(s), volume-issue number(s), publisher, city and/or country where published.	T ²
	E	ETSI: "Universal Mobile Telecommunications System (UMTS); Telecommunications Management; Charging and Billing; 3G Call And Even Data For The Packet Switched (PS) Domain (3GPP TS 32.015 version 3.12.0 Release 1999) ETSI TS 132 015 V3.12.0 (2003-12) 31 December 2003 (2003-12-31) Pages 1-66.	
	F	"3rd Generation Partnership Project," March 2004 (2004-03), 3GPP TS 23.125 V6.0.0, XX, XX, Page(s) 1-29.	
	G	Communication and Supplemental European Search Report corresponding to European Patent Application Serial No. EP 05738259.0-1525, European Patent Office, dated February 22, 2007, 5 pages.	

*EXAMINER: Initial if reference considered, whether or not citation is in conformance with MPEP 609. Draw line through citation if not in conformance and not considered. Include copy of this form with next communication to applicant.

¹Applicant's unique citation designation number (optional). ²Applicant is to place a check mark here if English language Translation is attached.

Examiner Signature		Date Considered	
--------------------	--	-----------------	--

(12) INTERNATIONAL APPLICATION PUBLISHED UNDER THE PATENT COOPERATION TREATY (PCT)

(19) World Intellectual Property
Organization
International Bureau



(43) International Publication Date
29 April 2004 (29.04.2004)

PCT

(10) International Publication Number
WO 2004/036890 A1

- (51) International Patent Classification⁷: H04M 15/00, H04L 12/14, 12/28
- (74) Agents: PELLMANN, Hans-Bernd et al.; TBK-Patent, Bavariaring 4-6, 80336 München (DE).
- (21) International Application Number: PCT/IB2002/003877
- (81) Designated States (*national*): AE, AG, AL, AM, AT, AU, AZ, BA, BB, BG, BR, BY, BZ, CA, CH, CN, CO, CR, CU, CZ, DE, DK, DM, DZ, EC, EE, ES, FI, GB, GD, GE, GH, GM, HR, HU, ID, IL, IN, IS, JP, KE, KG, KP, KR, KZ, LC, LK, LR, LS, LT, LU, LV, MA, MD, MG, MK, MN, MW, MX, MZ, NO, NZ, OM, PH, PL, PT, RO, RU, SD, SE, SG, SI, SK, SL, TJ, TM, TN, TR, TT, TZ, UA, UG, US, UZ, VN, YU, ZA, ZM, ZW.
- (22) International Filing Date: 20 September 2002 (20.09.2002)
- (25) Filing Language: English
- (26) Publication Language: English
- (71) Applicant (*for all designated States except US*): NOKIA CORPORATION [FI/FI]; Keilalahdentie 4, FIN-02150 Espoo (FI).
- (72) Inventors; and
- (75) Inventors/Applicants (*for US only*): LIALIAMOU, Elena [GR/FI]; Westendintie 93 F 35, FIN-02160 Espoo (FI). STURA, Marco [FI/FI]; Koivuviita 7 B 6, FIN-02130 Espoo (FI). KOSKINEN, Juha-Pekka [FI/FI]; Heinäjoenkatu 13, FIN-13210 Hämeenlinna (FI). NARHI, Anne [FI/FI]; Väälisalonkuja 8 A 5, FIN-33400 Tampere (FI).
- (84) Designated States (*regional*): ARIPO patent (GH, GM, KE, LS, MW, MZ, SD, SL, SZ, TZ, UG, ZM, ZW), Eurasian patent (AM, AZ, BY, KG, KZ, MD, RU, TJ, TM), European patent (AT, BE, BG, CH, CY, CZ, DE, DK, EE, ES, FI, FR, GB, GR, IE, IT, LU, MC, NL, PT, SE, SK, TR), OAPI patent (BF, BJ, CF, CG, CI, CM, GA, GN, GQ, GW, ML, MR, NE, SN, TD, TG).

Published:

— with international search report

For two-letter codes and other abbreviations, refer to the "Guidance Notes on Codes and Abbreviations" appearing at the beginning of each regular issue of the PCT Gazette.

(54) Title: METHOD FOR CHARGING OF DATA REACHING A NETWORK ELEMENT OF A COMMUNICATION NETWORK DURING A DATA SESSION

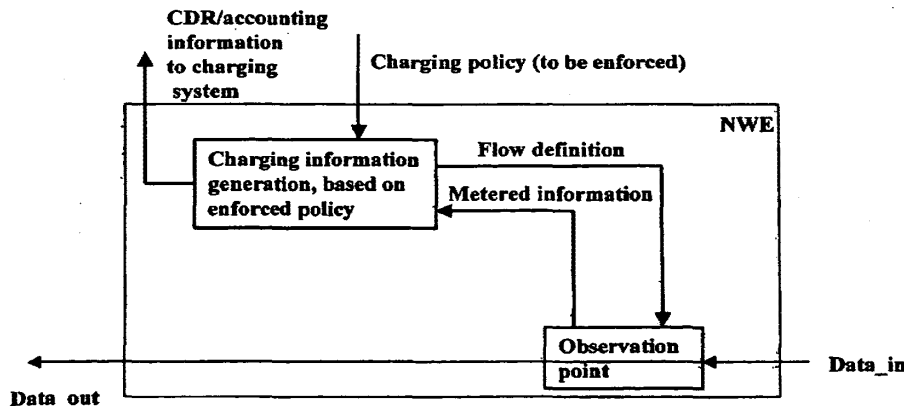

(57) Abstract: The present invention proposes a method for charging of data reaching a network element of a communication network during a data session, the data session comprising a plurality of data flows, with each flow being distinguishable by a set of flow parameters, the method comprising the steps of: enforcing a charging policy at the network element to be applied to said data, wherein said charging policy defines charging rules per flow; observing said data reaching said network element and detecting at least one flow of data; and matching said detected flow of data to an enforced charging policy, applying said matching charging policy to said flow, thereby generating charging information. Also, the present invention concerns a method for supplying a network element with a charging policy to be enforced at said network element for charging of data reaching said network element of a communication network during a data session. Additionally, corresponding devices are concerned by the present invention.

WO 2004/036890 A1

- 1 -

TITLE OF THE INVENTION

Method for charging of data reaching a network element of a communication network during a data session

5

FIELD OF THE INVENTION

The present invention relates to a method for charging of data reaching a network element of a communication network during a data session, and correspondingly to a method for supplying a network element with a charging policy to be enforced at said network element for charging of data reaching said network element of a communication network during a data session.

15

BACKGROUND OF THE INVENTION

Recently, communication networks have penetrated more and more in every day life and are adopted by subscribers for more and more services such as phone calls, data transmission and the like. Also, so-called value added services are implemented using communication networks.

With the increasing number of possible services available for subscription in communication networks, also new network types and/or subnetworks are emerging, while interoperability therebetween is still given.

In view of this variety of services to be subscribed and different networks/subnetworks used by subscribers when using their terminals, network operators are facing challenges in implementing new value added services based on messaging applications over e.g. GPRS (General Packet Radio Services).

35

CONFIRMATION COPY

- 2 -

With the increasing variety of services and the different qualities of services a subscriber can subscribe to, charging and/or billing for services offered by the network and used by the subscriber becomes rather complex.

5

Therefore, in this connection a new type of mediation functionality for charging is needed, which is capable of coping with additional requirements related to managing prepaid challenges, controlling charging logic based on context and processing capabilities of collected charging information.

10

SUMMARY OF THE INVENTION

Consequently, according to an aspect of the present invention, it is an object of the present invention to provide an improved method for charging of data reaching a network element of a communication network during a data session.

20

In addition, according to a further aspect of the present invention, it is an object of the present invention to provide an improved method for supplying a network element with a charging policy to be enforced at said network element for charging of data reaching said network element of a communication network during a data session.

25

According to an aspect of the present invention, the above object is for example achieved by a method for charging of data reaching a network element of a communication network during a data session, the data session comprising a plurality of data flows, with each flow being distinguishable by a set of flow parameters, the method comprising the steps of: enforcing a charging policy at the network element to be applied to said data, wherein said

30

35

- 3 -

charging policy defines charging rules per flow; observing said data reaching said network element and detecting at least one flow of data; and matching said detected flow of data to an enforced charging policy, applying said matching charging policy to said flow, thereby generating charging information.

According to favorable further developments of the method,
- the method comprises a step of forwarding said generated charging information to a charging system of the communication network;

- enforcing is performed upon start-up of the network element;

- enforcing is performed upon activation of the data session;

- enforcing is performed dynamically during the lifetime of the data session;

- upon enforcing said charging policy, data volume counters and/or time counters are initialized.

- said data flows are Internet Protocol based packet data flows, and said flow parameters comprise at least one of an IP header field, a transport header field, and an application level information;

- said charging policy comprises at least one flow parameter, and at least one of a charging/accounting type, an accounting event trigger, a charging metrics, and a tariffing indication;

According to a further aspect of the present invention, the above object is for example achieved by a method for supplying a network element with a charging policy to be enforced at said network element for charging of data reaching said network element of a communication network during a data session, the method comprising the step of: creating a plurality of charging policies, each comprising at least one flow parameter, and at least one of a

- 4 -

charging/accounting type, an accounting event trigger, a charging metrics, and a tariffing indication, selecting a charging policy based on offered services and subscriber information, and distributing said selected charging policy
5 to at least one network element.

According to favorable further developments of the method,
- a charging policy is selected for a type of a network element.

10

Furthermore, according to the present invention, the above objects are for example achieved by a device for charging of data reaching a network element of a communication network during a data session, the data session comprising
15 a plurality of data flows, with each flow being distinguishable by a set of flow parameters, the system comprising: enforcing means adapted to enforce a charging policy at the network element to be applied to said data, wherein said charging policy defines charging
20 rules per flow; observation means adapted to observe said data reaching said network element and detecting at least one flow of data; and matching means adapted to match said detected flow of data to an enforced charging policy, application means adapted to apply said matching charging
25 policy to said flow, and generation means, responsive to said application means, adapted to generate charging information.

According to favorable further developments:

30 - the device further comprises forwarding means adapted to forward said generated charging information to a charging system of the communication network;
- said enforcing means are responsive to a start-up of the network element to perform the enforcing;

- 5 -

- said enforcing means are responsive to activation of the data session to perform the enforcing;
- said enforcing means are dynamically performing the enforcing during the life-time of the data session;
- 5 - the device further comprises initialization means adapted to initialize data volume counters and/or time counters responsive to enforcing said charging policy;
- said data flows are Internet Protocol based packet data flows, and said flow parameters comprise at least one of an
10 IP header field, a transport header field, and an application level information;
- said charging policy comprises at least one flow parameter, and at least one of a charging/accounting type, an accounting event trigger, a charging metrics, and a
15 tariffing indication.

Furthermore, according to the present invention, the above objects are for example achieved by a device for supplying a network element with a charging policy to be enforced at
20 said network element for charging of data reaching said network element of a communication network during a data session, the device comprising creation means adapted to create a plurality of charging policies, each comprising at least one flow parameter, and at least one of a
25 charging/accounting type, an accounting event trigger, a charging metrics, and a tariffing indication, selection means adapted to select a charging policy based on offered services and subscriber information, and distribution means adapted to distribute said selected charging policy to at
30 least one network element.

According to favorable further developments a charging policy is selected for a type of a network element.

- 6 -

By virtue of the present invention, which proposes a generally improved method for charging of data reaching a network element of a communication network during a data session and an improved method for supplying a network element with a charging policy to be enforced at said
5 network element for charging of data reaching said network element of a communication network during a data session, basically the following advantages can be achieved

- access charges are based on metering of data
10 sessions, which may contain several flows, which in turn may be charged differently, e.g. reverse charged, free of charge;
- charging end user (subscriber) for services provided directly by third parties while also differentiating
15 charges for the access bearer;
- provisioning of charging logic and control of the proper real time metering and accounting mechanism differently per each flow of a specific service type.

20 BRIEF DESCRIPTION OF THE DRAWINGS

In the following, the present invention will be described in greater detail with reference to the accompanying drawings, in which

25

Fig. 1 shows in schematic outline the functionalities and steps involved in the method for supplying a network element with a charging policy to be enforced at said network element for charging of data reaching said network
30 element of a communication network during a data session; and

Fig. 2 shows in schematic outline the functionalities and steps involved in the method for charging of data reaching

- 7 -

a network element of a communication network during a data session.

Fig. 3 shows details of a device for charging of data reaching a network element of a communication network during a data session.

DETAILED DESCRIPTION OF THE EMBODIMENTS

10 In brief, with the proposed charging mediation functionality, through a policy management interface the operator is allowed to create and manage charging policies. A charging policy decision logical function selects the appropriate charging policy according to the offered
15 services and relevant subscription information. Via the charging policy control interface, the charging policy is sent to one or more network elements where it is locally enforced to relevant processes. Charging policies for access network devices such as GGSN are being considered
20 but it can also apply to other network elements depending on the relevant needs such as core network elements, as will be set out in greater detail herein below.

In order to create charging policies for access network
25 devices, a flow definition such as an IP flow definition is required. An IP flow, or any other flow which need not necessarily be based on the Internet Protocol IP, is a set of packets passing an observation point in the network during a certain time interval A set of IP flows (one or
30 more) can correspond to the usage of a certain application or service differing from an application flow. There are services which use single IP flow or services which use more than one IP flows such as for example streaming or rich call. All packets belonging to a particular flow have
35 a set of common properties derived from the data contained

- 8 -

in the packet and from the packet treatment at the observation point. In the GPRS or 3G networks, the observation point can be a Gateway GPRS Support Node GGSN with additional capabilities. Packets are mapped to flows
5 by evaluating their properties. Packets with common properties are considered to belong to the same flow. A packet showing at least one difference in the set of properties is considered to belong to a different flow. Depending on the specific case, only a subset of the
10 properties could be used to distinguish flows or else extra parameters such as application level information (e.g. Uniform Resource Locator URL) may be required to distinguish application data flows (consisting of one or more IP flows)

15

This will be explained in greater detail with reference to Fig. 1. Fig. 1 shows in schematic outline the charging mediation functionality CMF and involved functionalities / steps involved in the method for supplying a network
20 element with a charging policy to be enforced at said network element for charging of data reaching said network element of a communication network during a data session.

As shown in Fig. 1, the charging mediation functionality
25 CMF comprises a policy management interface functionality. This policy management interface is adapted to create charging policies. The creation is based on an operator input as well as on input flow definitions. A flow definition defines a flow of data, which are packet data.
30 Thus, properties of the packets define a flow in that all packets having the same properties belong to the same flow. A property of a packet and/or flow is also referred to as attribute.

- 9 -

Among the items input as operator input there are at least one of a charging/accounting type, an accounting event trigger, a charging metrics, and a tariffing indication, which is/are mapped and/or assigned to a corresponding flow distinguished from other flows by a set of packet flow attributes. For example, charging/accounting type is defined by an indication whether online accounting (prepaid, hot billing) or off-line accounting is to be effected. As accounting event triggers are possible (either one or several in combination): QoS changes, tariff changes, time thresholds and/or volume thresholds. Charging metrics include a volume metering (which is On/Off), a time metering (which is On/Off), a QoS metering (which is On/Off) (either one or several in combination). Further, tariffing comprises an indication of the tariff class and a co-assigned value of the tariff.

The above input is supplied by the operator, e.g. „manually,, or as a preconfigured file.

As regards properties of the packets defining a flow, these properties may also be input by the operator as the above items. Nevertheless, the properties may also be supplied as a result obtained at an observation point or measurement device monitoring data flows or directly by an application. Irrespective of whether input manually or as a result of a measurement or by an application, the properties/attributes of the packets defining a flow may comprise for example source address and port; destination address and port; Layer 3 Protocols used (Network protocols); TOS (IPv4 Type Of Service); Traffic Class (IPv6); Flow Identifier; URL (if needed); Destination Classification such as internal / partner / external (e.g. „Sonera,, partner or external).

- 10 -

To each set of attributes/properties of a flow is mapped a corresponding set of operator specified input items listed above to thereby define a charging policy for the respective flow.

5

Thus, at the output of the policy management interface as plurality of charging policies and/or charging rules is defined, which serve as an input to a charging policy decision/selection functionality. At the selection
10 functionality, a charging policy is selected out of said plurality of policies. The selection is based on information on offered services as well as information on relevant subscribers also supplied to the selection
15 functionality. The information related to offered services is provided by the network operator, e.g. upon network configuration, while information on relevant subscribers can be obtained e.g. from subscriber databases such as the home subscriber server HSS or the like.

20 At the output of the selection functionality, one charging policy is then present which is distributed via a charging policy control functionality to one or more network elements. The charging policy thus selected may for example be selected for a specific network element type such as an
25 access network element (e.g. GGSN) or a core network element (e.g. Application server APS or Call Processing server CPS (sometimes also denoted as Connection Processing Server)). Then, the selected charging policy can be distributed to all network elements of the same type
30 concerned.

The above description has mainly be given with regard to the parameters used in connection with access network elements, while in case of core network elements, at least
35 the following parameters as an example could at least be

- 11 -

part of a charging policy delivered to the core network elements (in addition or alternatively to those mentioned above in connection with access network elements): charging/accounting type (online accounting (prepaid, hot 5 billing), off-line accounting), accounting event triggers (URL, time change, service class change, add/remove media component, Session Initiated Protocol SIP Method 1 with list of messages, SIP Method n with list of messages), charging metrics (content size (On/Off), time metering 10 (On/Off), number of transactions (On/Off), tariffing (tariff class and value).

Charging policies could be enforced to core network elements such as CPS to indicate which event, sequence of events or actions could trigger accounting actions.

15 Thus, with regard to the method for supplying a network element with a charging policy to be enforced at said network element for charging of data reaching said network element of a communication network during a data session, the foregoing made clear that the method comprises the 20 steps of creating a plurality of charging policies, each comprising at least one flow parameter, and at least one of a charging/accounting type, an accounting event trigger, a charging metrics, and a tariffing indication, selecting a charging policy based on offered services and subscriber 25 information, and distributing said selected charging policy to at least one network element.

Also, a respective charging policy is for example selected for a type of a network element and distributed to all 30 network elements of said specific type. In case of access network elements such as GGSN, enforced charging policies for Access Network Devices such as GGSN define the triggering detection points for a chargeable flow.

- 12 -

Fig. 2 shows in schematic outline the functionalities and steps involved in the method for charging of data reaching a network element of a communication network during a data session.

5

As shown, data reaching a network element (data_in) pass through an observation point (here illustrated to be located in the network element). An observation point is a measurement equipment located in the network at which data packets such as IP based packets can be observed and their properties can be determined. Examples are a line to which a probe is attached, a shared medium such as an Ethernet based Local Area Network LAN, a single port of a router or a set of interfaces (physical or logical) of a router. As a result of the flow or flows being observed at the observation point, a flow record (per flow) is obtained. A flow record contains information about a specific flow that was metered at the observation point, and more particularly, contains measure properties of the flow such as the total number of bytes of all packets of the flow and usually characteristic properties of the flow such as an IP source address. A plurality of flows are also referred to as a session. Such a session may for example be a PDP context (PDP: Packet Data Protocol) or any other logical context.

Stated in other words, the observation point yields information on flow definitions of the flows contained in the current session, the data of which are passing through the observation point.

These information on the flows, i.e. the flow records of the individual flows are forwarded to a charging information generation entity. At the charging information generation entity, the charging policies received from the

- 13 -

charging mediation functionality are enforced, i.e. rendered valid for charging purposes. Thus, based on the enforced charging policy at the network element and the observed flow parameters (metered information), charging information is generated and forwarded, e.g. as a call detail record CDR (also referred to as a Charging Data record) or as a RADIUS/DIAMETER accounting information (Remote Authentication Dial In User Service (RADIUS)), to a charging system of the network.

10

Stated in other words, the present invention concerning a method for charging of data reaching a network element of a communication network during a data session, the data session comprising a plurality of data flows, with each flow being distinguishable by a set of flow parameters, comprises the steps of enforcing a charging policy at the network element to be applied to said data, wherein said charging policy defines charging rules per flow; observing said data reaching said network element and detecting at least one flow of data; and matching said detected flow of data to an enforced charging policy, and applying said matching charging policy to said flow, thereby generating charging information.

15

20

25

Of course, there is also conceived a forwarding of said generated charging information to a charging system of the communication network.

30

The charging policy for access network devices defines, in case of an IP flow as an example of a flow of a session such as a PDP context, the IP flow specification that must be distinguished upon being measured as well as the relevant accounting action to be taken upon being distinguished. A charging policy can for example suppress

- 14 -

accounting/charging for the distinguished data flow and assign a tariff class 0.

Enforcement of charging policies to access network devices such as GGSN can be realized during start up or upon session, i.e. PDP context activation. In addition, charging policies can be enforced to access network devices such as a GGSN dynamically during the context lifetime. When a charging policy is enforced to the access network device, it initiates the creation of volume and/or time counters. Such counters are initiated upon receiving the charging policy and appropriate accounting actions are triggered as specified within the charging policy. Charging policy enforced to GGSN in principle remains active only during the lifetime of the context. However, in certain cases, it is possible to maintain charging policies active within the access network device regardless of the context lifetime. Such charging policies apply for services independently of the subscriber base. Furthermore, application level information carried as payload within the IP packets such as URL specification can be needed as parameters in order to distinguish the IP Flow. In particular, there are several occasions on which the information at Layer 2/Layer 3 is not enough to distinguish the appropriate IP Flow, and in which cases the application level information will additionally be referred to for unambiguously distinguishing the flows (at least one) which correspond to the use of the application or service.

Thus, summing up the above, as regards the enforcing, this is performed upon start-up of the network element, while enforcing may also be performed upon activation of the data session (such as a PDP context). Considering an active session, enforcing may also be performed dynamically during the life-time of the data session.

- 15 -

It is further to be understood that upon enforcing said charging policy, data volume counters and/or time counters are initialized at the network element, more specifically, at the charging information generation functionality.

5 Even though said data flows are not restricted to Internet Protocol based packet data flows, and in case of IP based data flows, said flow parameters comprise at least one of an IP header field, a transport header field, and an application level information.

10

More particularly, as regards the flow parameters to be observed, concerning

- IP Header Fields, the measuring device is capable of separating the flows by the following fields of the IP header as indicated: Source IP address, Destination IP address, Transport protocol type (Layer 4 protocol type),
15 IP version number, TOS (IPv4 Type of Service), Traffic Class (IPv6);

- Transport Header Fields, the measuring device is
20 capable of separating flows by the port numbers of the transport header in case of Transmission Control Protocol TCP or User Datagram Protocol UDP being used as transport protocol. Both source and destination port number are supported for distinguishing flows, individually as well as
25 in combination;

- application level information carried as payload within the data packets (e.g. URL), this information can also be used as parameter to distinguish data flows (at least one data flow).

30

An enforced charging policy comprises, as stated further above at least one flow parameter as mentioned above, and at least one of a charging/accounting type, an accounting event trigger, a charging metrics, and a tariffing
35 indication (explained above).

- 16 -

Even though herein above the present invention has been described with a focus on the method aspect, it is of course to be understood that the invention also concerns
5 corresponding devices.

Fig. 3 shows details of such a device, labeled in Fig. 2 merely as „charging information generation, based on enforced policy“, which are surrounded in Fig. 3 by a
10 dashed line.

Thus, the device for charging of data reaching a network element of a communication network during a data session, the data session comprising a plurality of data flows, with
15 each flow being distinguishable by a set of flow parameters, comprises enforcing means adapted to enforce a charging policy at the network element to be applied to said data, wherein said charging policy defines charging rules per flow. The policy/policies is/are received from
20 outside, e.g. from a device for supplying a network element with a charging policy to be enforced and as described later on.

Furthermore, an observation means is provided which is
25 adapted to observe said data reaching said network element and detecting at least one flow of data. The observation means may be part of the device for charging or considered as a separate unit, while however it is in cooperation with the device for charging if considered separate.

30 In addition, the device comprises a matching means adapted to match said detected flow of data to an enforced charging policy, and application means adapted to apply said matching charging policy to said flow, and still further

- 17 -

generation means, responsive to said application means, adapted to generate charging information.

The charging policy is received at the enforcing means
5 where it is rendered valid to be enforced and e.g. buffered
in a memory (not shown). The enforcing means informs the
matching means of the policy. The matching means in turn
supplies a flow definition (to be detected) to the
10 observation means, which returns information on detected
flow definitions to the matching means. In case the flow
definitions (the detected and the one to be detected) are
matching (identical), the matching means triggers the
application means to apply the enforced policy to metered
15 information received from the observation means. The
application means then forwards the available information
to the generation means where the charging information as
such is generated.

In addition, as shown in Fig. 3, the device further
20 comprises forwarding means adapted to forward said
generated charging information from the generation means to
a charging system of the communication network.

Similarly as explained in connection with the corresponding
25 method, said enforcing means are responsive to a start-up
of the network element to perform the enforcing, or said
enforcing means are responsive to activation of the data
session to perform the enforcing, or said enforcing means
are dynamically performing the enforcing during the life-
30 time of the data session.

Also, the device further comprises initialization means
(not shown) which are adapted to initialize data volume
counters and/or time counters responsive to enforcing said
35 charging policy.

- 18 -

Like in connection with the explanations of the method further above, Said data flows are Internet Protocol based packet data flows, and said flow parameters comprise at least one of an IP header field, a transport header field, and an application level information. Said charging policy comprises at least one flow parameter, and at least one of a charging/accounting type, an accounting event trigger, a charging metrics, and a tariffing indication.

10

Also, even though not shown in detail in the Figures, but as outlined in Fig. 1, the present invention concerns a device for supplying a network element with a charging policy to be enforced at said network element for charging of data reaching said network element of a communication network during a data session, the device comprising creation means adapted to create a plurality of charging policies, each comprising at least one flow parameter, and at least one of a charging/accounting type, an accounting event trigger, a charging metrics, and a tariffing indication, selection means adapted to select a charging policy based on offered services and subscriber information, and distribution means adapted to distribute said selected charging policy to at least one network element. A charging policy is selected for a type of a network element.

Accordingly, as has been described herein before, the present invention proposes a method for charging of data reaching a network element of a communication network during a data session, the data session comprising a plurality of data flows, with each flow being distinguishable by a set of flow parameters, the method comprising the steps of: enforcing a charging policy at the network element to be applied to said data, wherein said

35

- 19 -

charging policy defines charging rules per flow; observing
said data reaching said network element and detecting at
least one flow of data; and matching said detected flow of
data to an enforced charging policy, applying said
5 matching charging policy to said flow, thereby generating
charging information. Also, the present invention concerns
a method for supplying a network element with a charging
policy to be enforced at said network element for charging
of data reaching said network element of a communication
10 network during a data session. Additionally, corresponding
devices are concerned by the present invention.

While the invention has been described with reference to a
preferred embodiment, the description is illustrative of
15 the invention and is not to be construed as limiting the
invention. Various modifications and applications may occur
to those skilled in the art without departing from the true
spirit and scope of the invention as defined by the
appended claims.

20

- 20 -

LIST OF REFERENCE SIGNS USED IN FIG. 1

- IN1:
Operator input (e.g. at least one of charging/accounting
5 type, an accounting event trigger, a charging metrics, and
a tariffing indication)
- IN2:
Flow definitions (packet properties), e.g. from observation
10 point or application
- P1:
policies
- 15 IN3:
Information on offered services (e.g. defined by operator)
- IN4:
Information on subscribers (e.g. from HSS)
20
- P2:
Selected policy (e.g. per network element type)
- P3:
25 Selected policy distributed to network elements such as of
type „GGSN“
- I/F: Interface
- 30 CMF: charging mediation functionality