

## CERTIFICATE OF TRANSLATION

I, JIANQING YU, CERTIFY THAT:

1. I am fluent in Chinese and English.
2. I have 15 years of Chinese-English translation experience, particularly in Patent areas.
3. I certify that the English-language document attached hereto, titled "A Method for Controlling Charging of Packet Data Service" is , to the best of my knowledge, a true and accurate translation from Chinese to English of Exhibit 1004.
4. I hereby declare that all statements made herein of my own knowledge are true and that all statements made on information and behalf are believed to be true; and further that these statements were made with the knowledge that willful false statements and the like so made are punishable by fine or imprisonment, or both, under Section 1001 of Title 18 of the United States Code.

Executed this 2<sup>nd</sup> day of November, 2016 in Surrey, BC, Canada.



---

Jianqing Yu

[stamp:] 040409

# Document made available under the Patent Cooperation Treaty (PCT)

International application number: PCT/CN05/000388

International filing date: 28 March 2005 (28.03.2005)

Document type: Certified copy of priority document

Document details: Country/Office: CN  
Number: 200410033721.9  
Filing date: 09 April 2004 (09.04.2004)

Date of receipt at the International Bureau: 24 May 2005 (24.05.2005)

Remark: Priority document submitted or transmitted to the International Bureau in compliance with Rule 17.1(a) or (b)



World Intellectual Property Organization (WIPO) - Geneva, Switzerland  
Organisation Mondiale de la Propriété Intellectuelle (OMPI) - Genève, Suisse

[stamp:] 040409

PCT/CN2005/000388

Proof

The attachment to the proof is a copy of the following patent application submitted to the patent office.

Filing date: 9 April, 2004

Application number: 200410033721.9

Application type: Invention

Title of the invention: A method for controlling charging of packet data service

Applicant: Huawei Technologies Co., Ltd.

Inventor or designer: Duan Xiaoqin

[seal:] [illegible]

Commissioner of the State Intellectual Property Office  
of the People's Republic of China:

[signature:] Wang Jingchuan

12 April, 2005

## Claims

---

1. A method for controlling charging of packet data service, characterized in that the method comprises the following steps:
- 5       A. the service data flow based charging rule function (CRF) sets a trigger event;  
      B. when said trigger event occurs, the traffic plane function (TPF) sends a Request Charging Rules to the CRF.
2. The method according to claim 1, characterized in that said Step A is: the CRF sets a trigger event and sends said trigger event to the TPF.
3. The method according to claim 2, characterized in that before said Step A the method further  
10 comprises:
- A0. A static trigger event is configured in the TPF and when said static trigger event occurs, the TPF sends a Request Charging Rules to the CRF.
4. The method according to claim 3, characterized in that before said static trigger event occurs the method further comprises: the TPF monitors the occurrence of said static trigger event.
- 15       5. The method according to claim 3, characterized in that said Request Charging Rules in Step A0 contains an event ID used to identify the static trigger event.
6. The method according to claim 3, 4, or 5, characterized in that said Step A is: after receiving the Request Charging Rules, the CRF sets a dynamic trigger event and sends said dynamic trigger event to the TPF.
- 20       7. The method according to claim 3, characterized in that after said Step A0 the method further comprises: the CRF provides a charging rule for the TPF.
8. The method according to claim 1, characterized in that before said Step B the method further comprises: the TPF stores said trigger event and monitors the occurrence of said trigger event.
9. The method according to claim 1, characterized in that said Request Charging Rules in Step B contains  
25 an event ID used to identify the trigger event.
10. The method according to claim 1, characterized in that after said Step B the method further comprises: the CRF provides a charging rule for the TPF.
11. The method according to claim 10, characterized in that the CRF determines said charging rule  
30 according to the occurred trigger event.

12. The method according to claim 1, characterized in that said trigger event is set by the CRF according to the stored information.

5 13. The method according to claim 1, characterized in that said trigger event is set by the CRF according to the charging-related input information provided by the application function (AF), or the online charging system (OCS), or the TPF, or any two or three of all.

## Description

---

### A Method for Controlling Charging of Packet Data Service

#### Technical Field

5 The present invention relates to the charging field, and in particular relates to a method for controlling charging of packet data service.

#### Background Art

With the wide applications of packet data service, how to accurately and reasonably charge for packet data service has become a popular concern of network operators.

10 Figure 1 is a flow chart of packet data protocol (PDP) context activation, data transmission, and PDP context deactivation. As shown in Figure 1, the implementation process of PDP context activation, data transmission, and PDP context deactivation in the general packet radio service (GPRS) comprises the following steps:

15 Step 101: The user equipment (UE) sends an Activate PDP Context Request to the serving GPRS support node (SGSN) and the Activate PDP Context Request contains information such as network layer service access point identifier (NSAPI), PDP type, access point name (APN), required QoS parameters, and transaction identifier (TI), wherein the NSAPI as a part of the tunnel identifier (TEID) between the SGSN and the gateway GPRS support node (GGSN) is used to identify the PDP context, the PDP type can be the peer-peer protocol (PPP) type, the Internet protocol (IP) type, or other else, an APN is provided by the UE for the SGSN (in this case, the SGSN addresses the corresponding GGSN according to the APN and the GGSN determines the external network to be accessed according to the APN) or no APN is provided by the UE for the SGSN (in this case, the SGSN selects the default APN according to the subscriber data of the UE), the QoS parameters are the quality requirements for the packet data service designated for the UE, and the TI is used by the UE to identify one PDP context.

25

Step 102: After receiving the Activate PDP Context Request, the SGSN performs a security check and encryption with the UE. This step is optional.

5 Step 103: The SGSN analyzes the address information of the GGSN according to the APN. If the SGSN is able to obtain the address information of the GGSN according to the APN, the SGSN creates a TEID for the PDP context. The TEID can be a combination of an international mobile subscriber identity (IMSI) with an NSAPI and is used to uniquely identify one PDP context between the SGSN and the GGSN. Then the SGSN sends a Create PDP Context Request to the GGSN. The Create PDP Context Request contains PDP type, PDP address, APN, QoS parameters, TEID, and selection mode, wherein the PDP address, an optional parameter, is the IP address of the UE (the Create PDP Context Request can contain no PDP address and in this case the  
10 GGSN allocates an IP address to the UE during subsequent processing, or the packet data network (PDN) which finally establishes a connection with the UE allocates an IP address to the UE) and the selection mode refers to the selection mode of the APN (that is to say, the APN is selected by the UE or the SGSN). If the SGSN is unable to obtain the address information of the GGSN according to the APN, the SGSN rejects the Activate PDP Context Request initiated by the UE.

15 Step 104: After receiving the Create PDP Context Request, the GGSN determines the external PDN according to the APN, then allocates a charging ID, starts charging, and negotiates the QoS. If the GGSN is able to satisfy the QoS of the QoS parameters, the GGSN returns a Create PDP Context Response to the SGSN. The Create PDP Context Response contains TEID, PDP address, backbone bearer protocol, QoS parameters, and charging ID. If the GGSN is unable to satisfy the QoS of the QoS parameters, the GGSN rejects the Create  
20 PDP Context Request initiated by the SGSN and the SGSN rejects the Activate PDP Context Request initiated by the UE.

Step 105: After receiving the Create PDP Context Response, the SGSN inserts an NSAPI and the address information of the GGSN into the PDP context to identify the PDP context, selects the radio priority according to the QoS parameters, and then returns an Activate PDP Context Accept to the UE. The Activate PDP Context  
25 Accept contains PDP type, PDP address, QoS parameters, radio priority, and PDP configuration options. The SGSN starts charging. The UE receives the Activate PDP Context Accept and establishes a route with the GGSN. At this time, a transmission channel is established between the UE and the PDN and data transmission is available.

Step 106: The UE performs data transmission with the PDN through the SGSN and the GGSN.

Step 107: Data transmission is completed and the UE sends a Deactivate PDP Context Request to the SGSN. The Deactivate PDP Context Request contains a TI.

5 Step 108: After receiving the Deactivate PDP Context Request, the SGSN performs a security check and encryption with the UE. This step is optional.

10 Step 109 to Step 111: The SGSN sends a Delete PDP Context Request to the GGSN. The Delete PDP Context Request contains a TEID. After receiving the Delete PDP Context Request, the GGSN stops the charging of the UE, deletes the corresponding PDP context of the TEID, and sends a Delete PDP Context Response to the SGSN. The Delete PDP Context Response contains the TEID. After receiving the Delete PDP Context Response, the SGSN stops the charging of the UE, deletes the corresponding PDP context of the TEID, and sends a Deactivate PDP Context Response to the UE. The Deactivate PDP Context Response contains the TI. After receiving the Deactivate PDP Context Response, the UE deletes the PDP context of the TI.

15 From the process described in Figure 1, it can be seen that in the current GPRS charging system, charging starts when the PDP context is activated and charging ends when the PDP context is deleted. Therefore, charging can only be based on the transmitted data traffic of the PDP context or based on the duration the PDP context is in the activated state. In practical applications, after a transmission channel is established between the UE and the PDN, the UE can perform various services based on one activated PDP context, however. That is to say, if the PDN can provide various services, for example, email sending and receiving service, wireless application protocol (WAP) browsing service, and file transfer protocol (FTP) service, various services that can  
20 be provided by the PDN can be borne by one activated PDP context after the UE establishes a transmission channel with the PDN. Network operators may adopt different charging modes for various services, however. For example, for the email sending and receiving service, metering charging can be triggered based on an email sending or receiving event, for the WAP browsing service, traffic-based charging can be adopted, and for the FTP service, traffic-based charging can also be adopted. The charging rate for the WAP browsing service is  
25 different from the charging rate for the FTP service, however. The prior GPRS charging system is completely unable to perform differential charging for different services borne by one PDP context.



For the above-mentioned situation, the 3rd Generation Partnership Project (3GPP) is now discussing how to implement flow based charging (FBC). When the user of the UE uses a packet data service, all transmitted and received IP flows or IP packets are generally called service data flows. That is to say, service data flows are a set of a plurality of IP flows. Therefore, FBC can truly reflect the resource occupation by a service data flow. For FBC, it can be considered that IP flows of different services borne by one PDP context are respectively screened out by some sieve-like filters and charging is respectively performed for IP flows screened out by different filters to achieve the purpose of respective charging of different service data flows. Thus, the charging granularity based on IP flows is by far smaller than the charging granularity based on one PDP context. The granularity can be considered as the size of a sieve hole. For the charging granularity based on one PDP context, one PDP context is a sieve hole, while for the charging granularity based on IP flows, one IP flow is a sieve hole and one PDP context contains a plurality of sieve holes. Therefore, as seen from a comparison of charging based on IP flows with charging based on one PDP context, charging based on IP flows can provide network operators with diversified charging means.

The structure, function requirements, and message exchange process of the FBC system are described in the 3GPP. Figure 2A shows the structure of the FBC system supporting online charging. The service control point (SCP) (201) of the customized application for mobile network enhanced logic (CAMEL) and the service data flow based credit control function (CCF) (202) form the online charging system (OCS) (206). The CCF (202) is connected to the service data flow based charging rule function (CRF) (203) through the Ry interface, the CRF (203) is connected to the application function (AF) (204) through the Rx interface, the CRF (203) is connected to the traffic plane function (TPF) (205) through the Gx interface, and the CCF (202) is connected to the TPF (205) through the Gy interface.

Figure 2B shows the structure of the FBC system supporting offline charging. The CRF (203) is connected to the AF (204) through the Rx interface, the CRF (203) is connected to the TPF (205) through the Gx interface, the TPF (205) is respectively connected to the charging gateway function (CGF) (207) and the charging collection function (CCF) (208) through the Gz interface.

5        According to the 3GPP's current division of the functional entities implementing FBC, the TPF (205) bears IP flows. When the bearer of IP flows is established, the TPF (205) sends a Request Charging Rules to the CRF (203) through the Gx interface. The Request Charging Rules contains information related to the user and the UE, bearer characteristics, and network related information, wherein the information related to the user and the UE can be an MSISDN or IMSI, and the network related information can be an MNC or MCC. In  
10        addition, since the bearer will be modified (for example, the QoS parameters will be re-negotiated) during IP flow transmission, when the QoS parameters of the same service used by the user are different, the charging rules may be different (for example, if the QoS of the QoS parameters decreases, the corresponding charging rate will also decrease). In this case, when the bearer is modified, the TPF (205) can resend a Request Charging Rules to the CRF (203) to request new charging rules; the CRF (203) selects proper charging rules according to  
15        the input information provided by the TPF (205) and returns the selected charging rules to the TPF (205). The charging rules include the charging mechanism, charging type, charging key, service data flow filter, and charging rule priority, wherein the charging mechanism can be online charging or offline charging, the charging type can be duration-based charging or traffic-based charging, the charging key is a charging rate related parameter (the CRF (203) can provide a charging rate related parameter to the TPF (205), instead of  
20        directly providing a charging rate), and the service data flow filter is used to indicate the IP flows which the TPF (205) will filter and then the TPF (205) performs charging for the filtered IP flows according to the charging rules. The service data flow filter can contain IP quintuple. The IP quintuple can include the source/destination IP address, source/destination port number, and protocol ID. For example, the CRF (203) instructs the TPF to filter IP flows whose source address is 10.0.0.1, destination address is 10.0.0.2,  
25        source/destination port number is 20, and protocol type is TCP and the TPF performs charging for the filtered IP flows according to the charging rule. Finally, when the bearer is deleted, the TPF (205) can also send a Request Charging Rules to the CRF (203) to require the CRF (203) to provide a new charging rule. In this case, the CRF (203) can require the TPF (205) to delete the previously established charging rule.

In addition, besides the CRF (203) determines the charging rule according to the input information of the TPF (205), the CRF (203) can determine the charging rule according to the input information of the AF (204) or the OCS (206). For example, the AF (204) notifies the CRF (203) of the type of the service currently used by the user and the CRF (203) selects a corresponding charging rule according to the service type.

5 In a GPRS network, the TPF (205) is a GGSN, the AF is a service gateway or service server, and the CRF (203) is a new logic entity. The TPF (205) is the execution point of charging rules and the CRF (203) is the control point of charging rules.

10 Figure 3A is a flow chart of the issuance of a charging rule when the bearer service is established. As shown in Figure 3A, when the bearer service is established, the implementation process of the issuance of a charging rule comprises the following steps:

Step 301A: The UE sends an Establish Bearer Service Request to the TPF. In a GPRS network, it is the GGSN that receives the Create PDP Context Request.

15 Step 302A: After receiving the Establish Bearer Service Request, the TPF sends a Request Charging Rules to the CRF. The Request Charging Rules contains the input information used by the CRF to determine the charging rule.

Step 303A to Step 304A: After receiving the Request Charging Rules, the CRF selects a charging rule according to the input information in the Request Charging Rules, and then returns a Provision Charging Rules to the TPF. The Provision Charging Rules can contain the selected charging rule.

5 Step 305A to Step 306A: After receiving the Provision Charging Rules, according to the charging rule selected by the CRF, the TPF establishes a new charging rule, or deletes the original charging rule, or deletes the original charging rule and establishes a new charging rule, and then returns an Establish Bearer Service Accept to the UE to accept the Establish Bearer Service Request initiated by the UE and continue the subsequent bearer service establishment process.

10 Figure 3B is a flow chart of the issuance of a charging rule when the bearer service is modified. As shown in Figure 3A, when the bearer service is modified, the implementation process of the issuance of a charging rule comprises the following steps:

Step 301B: The UE sends a Modify Bearer Service Request to the TPF. In a GPRS network, it is the GGSN that receives the Update PDP Context Request.

15 Step 302B: After receiving the Modify Bearer Service Request, the TPF sends a Request Charging Rules to the CRF. The Request Charging Rules contains the input information used by the CRF to determine the charging rule.

Step 303B to Step 304B: After receiving the Request Charging Rules, the CRF selects a charging rule according to the input information in the Request Charging Rules, and then returns a Provision Charging Rules to the TPF. The Provision Charging Rules can contain the selected charging rule.

20 Step 305B to Step 306B: After receiving the Provision Charging Rules, according to the charging rule selected by the CRF, the TPF establishes a new charging rule, or deletes the original charging rule, or deletes the original charging rule and establishes a new charging rule, and then returns a Modify Bearer Service Accept to the UE to accept the Modify Bearer Service Request initiated by the UE and continue the subsequent bearer service modification process.

25 Figure 3C is a flow chart of the issuance of charging rules when the bearer is deleted. As shown in Figure 3C, when the bearer is deleted, the implementation process of the issuance of charging rules comprises the following steps:

Step 301C: The UE sends a Remove Bearer Service Request to the TPF. In a GPRS network, it is the GGSN that receives the Delete PDP Context Request.

30

Step 302C: After receiving the Remove Bearer Service Request, the TPF sends a Request Charging Rules to the CRF. The Request Charging Rules contains the input information used by the CRF to determine the charging rule.

5 Step 303C to Step 304C: After receiving the Request Charging Rules, the CRF selects a charging rule according to the input information in the Request Charging Rules, and then returns a Provision Charging Rules to the TPF. The Provision Charging Rules can contain the selected charging rule.

10 Step 305C to Step 306C: After receiving the Provision Charging Rules, according to the charging rule selected by the CRF, the TPF establishes a new charging rule, or deletes the original charging rule, or deletes the original charging rule and establishes a new charging rule, and then returns a Remove Bearer Service Accept to the UE to accept the Remove Bearer Service Request initiated by the UE and continue the subsequent bearer service deletion process.

15 In addition, the CRF can also proactively send a charging rule to the TPF. For example, during service data transmission between the UE and the AF, after receiving charging related input information from the AF, the CRF selects a proper charging rule according to the input information provided by the AF, and then proactively sends the selected charging rule to the TPF. Figure 4 shows the specific implementation process of how the AF provides charging related input information for the CRF.

Step 401: The AF sends an Application/Service Data Flow Charging Information to the CRF.

Step 402: After receiving the Application/Service Data Flow Charging Information, the CRF returns an Ack to the AF to notify the AF of the receipt of the charging information.

20 Figure 5 is a flow chart of how the CRF proactively sends a charging rule to the TPF. As shown in Figure 5, the implementation process of how the CRF proactively sends a charging rule to the TPF comprises the following steps:

Step 501: The CRF receives an Internal or External Trigger Event and the information related to the event, for example, the event that the AF sends input information for the selection of a charging rule to the CRF.

25 Step 502: The CRF selects a corresponding charging rule according to the obtained information. The obtained information can be the charging information provided by the AF, for example, special charging requirements for a service provided by the AF for a user, such as charging rate different from those of other services.

Step 503: If required, the CRF sends a Provision Charging Rules to the TPF. The Provision Charging Rules can contain the selected charging rule.

Step 504: After receiving the Charging Rules Response, according to the charging rule selected by the CRF, the TPF establishes a new charging rule, or deletes the original charging rule, or deletes the original charging rule and establishes a new charging rule.

According to the exchange of a charging rule between the TPF and the CRF defined in the current 3GPP standard, when a trigger event occurs (for example, the bearer service needs to be established, modified, or deleted), the TPF sends a Request Charging Rules to the CRF, and the CRF selects a proper charging rule according to the information in the Request Charging Rules and sends the selected charging rule to the TPF. Thus, the events of a Request Charging Rules are controlled by the TPF and are pre-configured in the TPF. For example, an event set for the Request Charging Rules is that the TPF needs to send a Request Charging Rules to the CRF when the bearer is established, modified, or deleted. In some cases, when the bearer service is modified, for example, the QoS parameters are modified, the differences between the QoS parameters after the modification and the QoS parameters before the modification are too small to reach a level at which the charging rule needs to be modified, however. If the TPF still sends a Request Charging Rules to the CRF in this case, the TPF will select a charging rule the same as the original charging rule and send it to the TPF. In this way, a lot of redundant information will inevitably be produced between the TPF and the CRF.

From the description above, it can be seen that although the CRF is the control point of charging rules in the 3GPP standard, the CRF cannot implement the complete control over charging.

### Summary of the Invention

In view of this, the present invention is intended to provide a method for controlling the charging of packet data service so that the control over the charging of packet data service is more reasonable and perfect.

To achieve the above-mentioned objective, the present invention provides a method for controlling the charging of packet data service. The method comprises:

A. the CRF sets a trigger event;

B. when said trigger event occurs, the TPF sends a Request Charging Rules to the CRF.

Said Step A is: the CRF sets a trigger event and sends said trigger event to the TPF.

Before said Step A, the method further comprises:

5 A0. A static trigger event is configured in the TPF and when said static trigger event occurs, the TPF sends a Request Charging Rules to the CRF.

Before said static trigger event occurs, the method further comprises: the TPF monitors the occurrence of said static trigger event.

The Request Charging Rules in Step A0 contains an event ID used to identify the static trigger event.

10 Said Step A is: after receiving the Request Charging Rules, the CRF sets a dynamic trigger event and sends said dynamic trigger event to the TPF.

After said Step A0, the method further comprises: the CRF provides a charging rule for the TPF.

Before said Step B, the TPF stores said trigger event and monitor the occurrence of said trigger event.

Said Request Charging Rules in Step B contains an event ID used to identify the trigger event.

15 After said Step B, the method further comprises: the CRF provides a charging rule for the TPF.

The CRF determines said charging rule according to the occurred trigger event.

Said trigger event is set by the CRF according to the stored information.

Said trigger event is set by the CRF according to the charging-related input information provided by the AF or the OCS or the TPF or any two or three of all.

20 In the present invention, the CRF determines the trigger event of the charging rule that the TPF needs to request of the CRF, and then sends the trigger event to the TPF; when the trigger event occurs, the TPF requests a charging rule of the CRF and provides charging related input information; the CRF selects a proper charging rule according to charging related input information and sends the selected charging rule to the TPF. In this way, the CRF can control the time when the TPF requests a charging rule of the CRF and redundant  
25 information caused when the TPF unnecessarily requests a charging rule of the CRF can be avoided so that message exchange between the TPF and the CRF is more efficient and the control over the charging of packet data service is more reasonable and perfect.

In addition, the CRF can obtain the charging related input information of the AF or OCS, and the charging related input information may affect charging rules. According to the method in the present invention, the CRF can flexibly set an event according to the charging related input information and then send the event to the TPF so that the TPF can request a new charging rule of the CRF when a certain condition is satisfied, namely, an event occurs. In this way, the applications of charging rules are more flexible and diversified. These functions cannot be implemented through message exchange between the prior TPF and CRF at all.

Brief Description of the Drawings

- Figure 1 is a flow chart of PDP context activation, data transmission, and PDP context deactivation.
- 10 Figure 2A shows the structure of the FBC system supporting online charging.
- Figure 2B shows the structure of the FBC system supporting offline charging.
- Figure 3A is a flow chart of the issuance of a charging rule when the bearer service is established.
- Figure 3B is a flow chart of the issuance of a charging rule when the bearer service is modified.
- Figure 3C is a flow chart of the issuance of a charging rule when the bearer service is deleted.
- 15 Figure 4 is a flow chart of how the AF provides charging related input information for the CRF.
- Figure 5 is a flow chart of how the CRF proactively sends a charging rule to the TPF.
- Figure 6 is a flow chart of how the CRF controls the TPF's sending Request Charging Rules in the present invention.
- Figure 7 is a schematic diagram for embodiment 1 of the present invention.
- 20 Figure 8 is a schematic diagram for embodiment 2 of the present invention.

Detailed Description of the Invention

To make clearer the objective, technical solution, and advantages of the present invention, the following will further describe the present invention in detail in combination with drawings.

25 In the present invention, the CRF determines the trigger events of the charging rules that the TPF needs to request of the CRF, and then sends the trigger events to the TPF; when a trigger event occurs, the TPF requests a charging rule of the CRF and provides charging related input information; the CRF selects a proper charging rule according to charging related input information and sends the selected charging rule to the TPF. In this way, the CRF can flexibly set trigger events according to the charging rules and charging modes to implement

30 complete control over charging so that the TPF can effectively request charging rules of the CRF to avoid generation of redundant information between the TPF and the CRF.



Figure 6 is a flow chart of how the CRF controls the TPF's sending Request Charging Rules in the present invention. As shown in Figure 6, the implementation process of how the CRF controls the TPF's sending a Request Charging Rules comprises the following steps:

5 Step 601: A static trigger event (for example, bearer service establishment) of a charging rule requested of the CRF is configured in the TPF. When the static trigger event occurs, the TPF sends a Request Charging Rules to the CRF. The Request Charging Rules contains charging related input information, such as information related to the user and the UE, bearer characteristics, and network related information. The Request Charging Rules additionally contains an event ID which is used to indicate that the current Request  
10 Charging Rules is triggered by the static trigger event.

In addition, a plurality of static trigger events, for example, bearer service establishment and bearer service deletion, can be configured in the TPF. When one of the static trigger events occurs, the TPF sends a Request Charging Rules to the CRF.

15 Step 602: After receiving the Request Charging Rules, the CRF sets the dynamic trigger event of the charging rule required by the TPF to request and then sends a Request Dynamic Event Report to the TPF. The Request Dynamic Event Report contains a dynamic events list of dynamic trigger event A, dynamic trigger event B, dynamic trigger event C, etc., which can be bearer service modification, modified different levels divided for the QoS parameters, or bearer service deletion.

20 Step 603: The CRF selects a proper charging rule according to the charging related input information in the Request Charging Rules and then sends a Provision Charging Rules to the TPF. The Provision Charging Rules can contain the selected charging rule, for example, charging rule 1.

The information which the CRF sends to the TPF in Step 602 and Step 603 can be contained in one message.

25 Step 604: After receiving the dynamic events list and the charging rule currently selected by the CRF, the TPF stores the dynamic events list, makes statistics of charging information according to the charging rule, and monitors the occurrence of dynamic trigger events.

Step 605: The TPF monitors the occurrence of dynamic trigger event A and sends a Request Charging Rules to the CRF. The Request Charging Rules contains a dynamic trigger event A occurrence indication.

Step 606: After receiving the Request Charging Rules, the CRF determines that the charging rule is triggered by dynamic trigger event A according to the dynamic trigger event A occurrence indication, selects a proper charging rule according to dynamic trigger event A, and then sends a Provision Charging Rules to the TPF. The Provision Charging Rules can contain the newly selected charging rule, for example, charging rule 2.

5 Step 607: After receiving the Provision Charging Rules, the TPF makes statistics of charging information according to the charging rule.

In the case of a plurality of dynamic trigger events, the TPF continues to monitor the occurrence of the other dynamic trigger events.

10 Step 608: The TPF monitors the occurrence of dynamic trigger event B and sends a Request Charging Rules to the CRF. The Request Charging Rules contains a dynamic trigger event B occurrence indication.

Step 609: After receiving the Request Charging Rules, the CRF determines that the charging rule is triggered by dynamic trigger event B according to the dynamic trigger event B occurrence indication, selects a proper charging rule according to dynamic trigger event B, and then sends a Provision Charging Rules to the TPF. The Provision Charging Rules can contain the newly selected charging rule, for example, charging rule 3.

15 Step 610: After receiving the Provision Charging Rules, the TPF makes statistics of charging information according to the charging rule.

The subsequent process is similar to the above-mentioned process and will not be described again here.

Moreover, in one session in a GPRS network, one session is one PDP context and the CRF can set dynamic trigger events for more than once and sends them to the TPF. For example, when receiving charging related input information of the AF or OCS, the CRF determines whether it is necessary to set a new dynamic trigger event according to the charging related input information. If yes, the CRF sets a new dynamic trigger event and sends it to the TPF. After receiving the new dynamic trigger event, the TPF stores the new dynamic trigger event and monitors its occurrence.

25 In addition, since static trigger events used to request charging rules of the CRF can be configured in the TPF, for some fixed events (for example, bearer service establishment, modification of QoS parameters of bearer service, traffic or duration reaching a certain fixed value, and bearer service deletion) static trigger events can directly be pre-configured in the TPF to report the change information of the bearer service to the CRF. But the CRF does not need to send dynamic trigger events to the TPF. The events of bearer service changes are fixed for some network operators or service providers. For example, they always require that the TPF reports bearer service changes to CRF when the service traffic reaches 10 M or when the service activation duration reaches 100 minutes, and no dynamically configured events are required. In this way, reporting can be implemented by only pre-configuring corresponding static trigger events in the TPF, without the CRF sending any dynamic trigger events to the TPF. Thus, the signaling load between the TPF and the CRF is reduced.

35

Figure 7 is a schematic diagram for embodiment 1 of the present invention. In embodiment 1, the static trigger event of the charging rule which the TPF requests of the CRF is set to bearer service establishment, the TPF sets the dynamic trigger event of the charging rule that the TPF needs to request of the CRF to bearer service modification and bearer service deletion, and the implementation process of how the CRF controls the TPF's sending a Request Charging Rules comprises the following steps:

Step 701: The UE sends an Establish Bearer Service Request to the TPF. In a GPRS network, it is the GGSN that receives the Create PDP Context Request.

Step 702: After receiving the Establish Bearer Service Request, the TPF determines that the static trigger event has occurred, and sends a Request Charging Rules to the CRF. The Request Charging Rules contains charging related input information, such as information related to the user and the UE, bearer characteristics, and network related information. The Request Charging Rules additionally contains an event ID which is used to indicate that the current Request Charging Rules is triggered by the static trigger event.

Step 703 to Step 704: After receiving the Request Charging Rules, the CRF determines that the Request Charging Rules is triggered by the static trigger event according to the event ID, then sets a dynamic events list containing bearer service modification and bearer service deletion, and sends a Request Dynamic Event Report to the TPF. The Request Dynamic Event Report contains the dynamic events list. In addition, the CRF can set a plurality of different values (for example, different levels of the QoS parameters) in the dynamic trigger event of bearer service modification, and each value can be used as an independent dynamic trigger event.

Step 705 to Step 706: The CRF selects a proper charging rule according to the charging related input information in the Request Charging Rules and then sends a Charging Rules Response to the TPF. The Charging Rules Response can contain the selected charging rule.

Step 707 to Step 708: After receiving the dynamic events list set by the CRF and the charging rule selected by the CRF, the TPF stores the dynamic events list, makes statistics of charging information according to the charging rule, and monitors the occurrence of the dynamic trigger events. The TPF returns Establish Bearer Service Accept to the UE to accept the Establish Bearer Service Request initiated by the UE and  
5 continue the subsequent bearer service establishment process.

Step 709: After some time, the UE sends a Modify Bearer Service Request to the TPF. In a GPRS network, it is the GGSN that receives the Update PDP Context Request.

Step 710: After receiving the Modify Bearer Service Request, the TPF determines that the dynamic trigger event of bearer service modification in the dynamic events list has occurred and sends a Request Charging  
10 Rules to the CRF. The Request Charging Rules contains a dynamic trigger event occurrence indication.

Step 711 to Step 712: After receiving the Request Charging Rules, the CRF determines that the charging rule is triggered by the dynamic trigger event of bearer service modification according to the dynamic trigger event occurrence indication, selects a proper charging rule according to the bearer service modification, and then sends a Charging Rules Response to the TPF. The Charging Rules Response can contain the selected  
15 charging rule.

Step 713 to Step 714: After receiving the Charging Rules Response, according to the charging rule selected by the CRF, the TPF establishes a new charging rule, or deletes the original charging rule, or deletes the original charging rule and establishes a new charging rule, and then returns a Modify Bearer Service Accept to the UE to accept the Modify Bearer Service Request initiated by the UE and continue the subsequent  
20 bearer service modification process.

Step 715: After some time, the UE sends a Remove Bearer Service Request to the TPF. In a GPRS network, it is the GGSN that receives the Delete PDP Context Request.

Step 716: After receiving the Remove Bearer Service Request, the TPF determines that the dynamic trigger event of bearer service deletion in the dynamic events list has occurred and sends a Request Charging  
25 Rules to the CRF. The Request Charging Rules contains a dynamic trigger event occurrence indication.

Step 717 to Step 718: After receiving the Request Charging Rules, the CRF determines that the charging rule is triggered by the dynamic trigger event of bearer service deletion according to the dynamic trigger event occurrence indication, selects a proper charging rule according to the bearer service deletion, and then sends a Charging Rules Response to the TPF. The Charging Rules Response can contain the selected charging rule.  
30

Step 719 to Step 720: After receiving the Charging Rules Response, according to the charging rule selected by the CRF, the TPF establishes a new charging rule, or deletes the original charging rule, or deletes the original charging rule and establishes a new charging rule, and then returns a Remove Bearer Service  
5 Accept to the UE to accept the Remove Bearer Service Request initiated by the UE and continue the subsequent bearer service deletion process.

In the prior art, the AF can send Application/Service Data Flow Charging Information to the CRF to serve as charging related input information according to which the CRF selects a charging rule. According to the method provided in the present invention, the AF can send Application/Service Data Flow Charging  
10 Information to the CRF to serve as input information according to which the CRF sets dynamic trigger events.

Figure 8 is a schematic diagram for embodiment 2 of the present invention. As shown in Figure 2, in embodiment 2, the implementation process of how the CRF sends a dynamic trigger event to the TPF comprises the following steps:

Step 801: The CRF receives an internal or external trigger event. For example, the AF provides a bonus  
15 point activity for users. If the data traffic of the AF's service accessed by a user reaches a certain value, then the charging rate for the user's subsequent access to the service will decrease, and in this case, the AF requires that the CRF should adopt a preferential charging rate to make statistics of charging information for subsequent data traffic when the data traffic of a service filter reaches a certain value. Or if the duration the user accesses a service of the AF reaches a certain value, the charging rate for the user's subsequent access to the service will  
20 decrease, and in this case, the AF requires that the CRF should adopt a preferential charging rate to make statistics of charging information for subsequent data traffic when the duration of a service filter reaches a certain value.

Step 802: The CRF configures a dynamic trigger event. For example, the CRF sets the dynamic trigger event to the data traffic of a service filter reaching a certain value or sets the dynamic trigger event to the  
25 service duration of a service filter reaching a certain value. In addition, the CRF can select a proper charging rule according to the information obtained currently, for example, user/UE information, bearer characteristics, and network related information provided by the TPF.

Step 803: The CRF sends a Request Dynamic Event Report to the TPF to require the TPF to request a charging rule of the CRF when a dynamic trigger event occurs. The Request Dynamic Event Report contains  
30 the dynamic events list which is currently set.

Step 804: The CRF sends a Charging Rules Response to the TPF. The Charging Rules Response can contain the currently selected charging rule. This step is optional.

5 Step 805: The TPF receives the dynamic events list currently set by the CRF and stores the dynamic events list. If the TPF additionally receives the Charging Rules Response, according to the charging rule selected by the CRF, the TPF establishes a new charging rule, or deletes the original charging rule, or deletes the original charging rule and establishes a new charging rule.

10 Step 806: After some time, the TPF monitors the occurrence of a dynamic trigger event and sends a Request Charging Rules to the CRF. The Request Charging Rules contains a dynamic trigger event occurrence indication.

15 Step 807 to Step 808: After receiving the Request Charging Rules, the CRF can determine the dynamic trigger event (for example, the data traffic of a service filter reaching a certain value or the service duration of a service filter reaching a certain value) triggering the Request Charging Rules according to the dynamic trigger event occurrence indication, selects a proper charging rule according to the dynamic trigger event, and sends a Charging Rule Response to the TPF. The Charging Rule Response can contain the selected charging rule.

20 Step 809: After receiving the Charging Rules Response, according to the charging rule selected by the CRF, the TPF establishes a new charging rule, or deletes the original charging rule, or deletes the original charging rule and establishes a new charging rule.

In addition, the CRF can dynamically set a dynamic trigger event according to the user credit related charging information sent from the OCS. The corresponding process is basically similar to the above-mentioned process and is not described again here.

In a word, the embodiments described above are preferred embodiments of the present invention, but are not used to limit the protection scope of the present invention.

25

Drawings

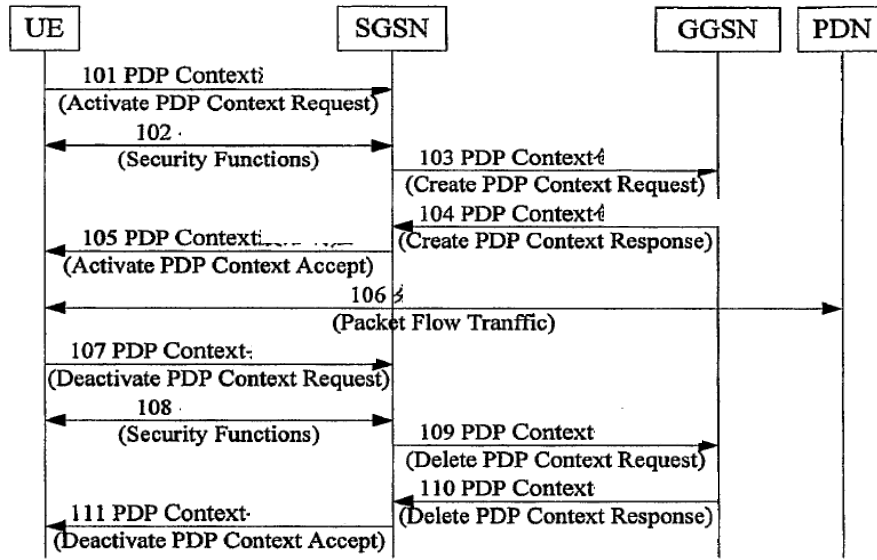

Figure 1

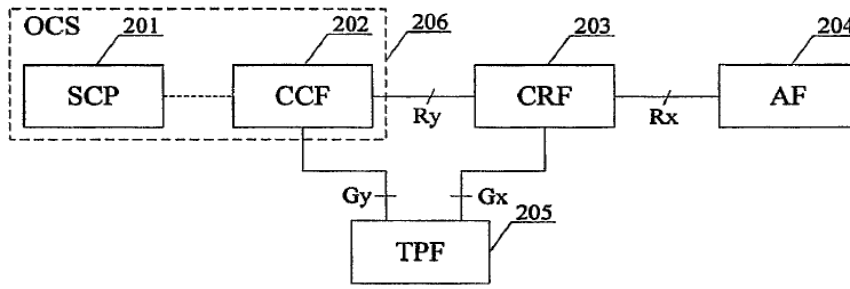

Figure 2A

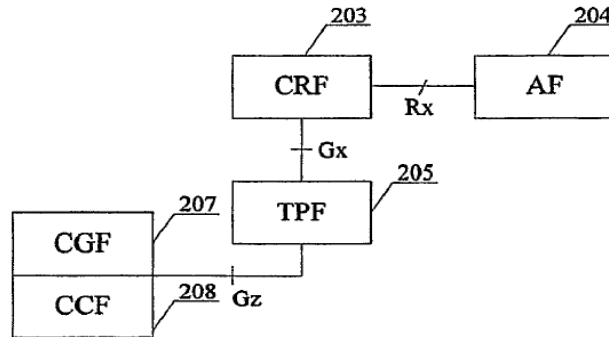

Figure 2B

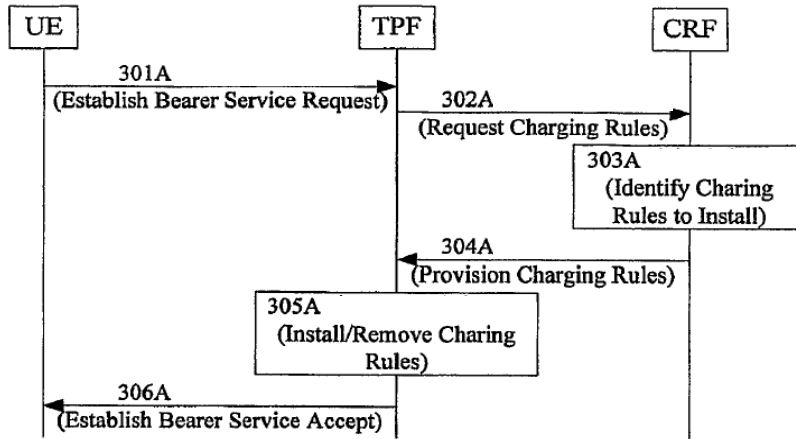

Figure 3A

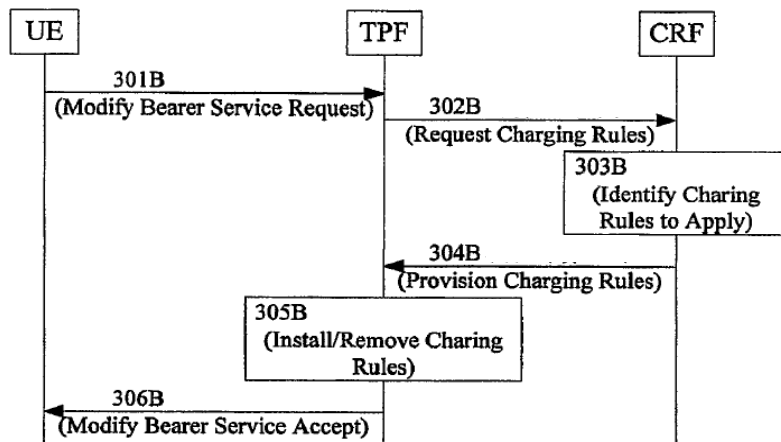

Figure 3B

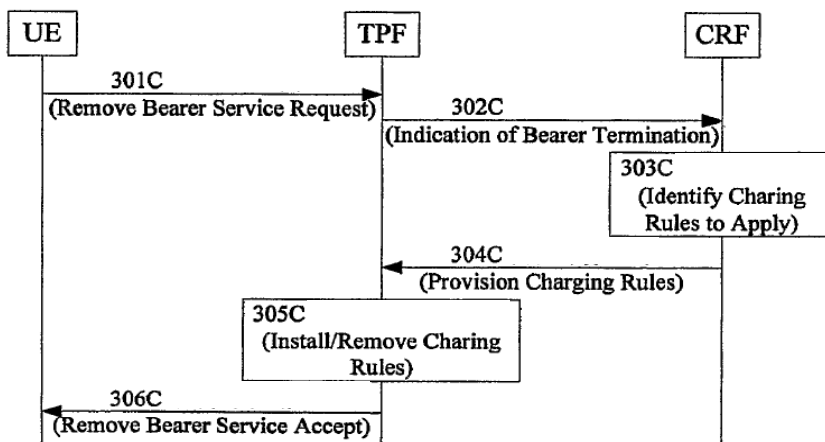

Figure 3C



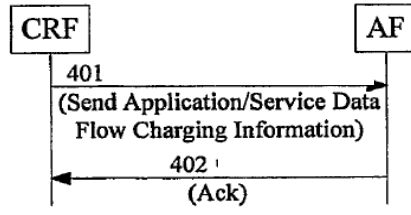

Figure 4

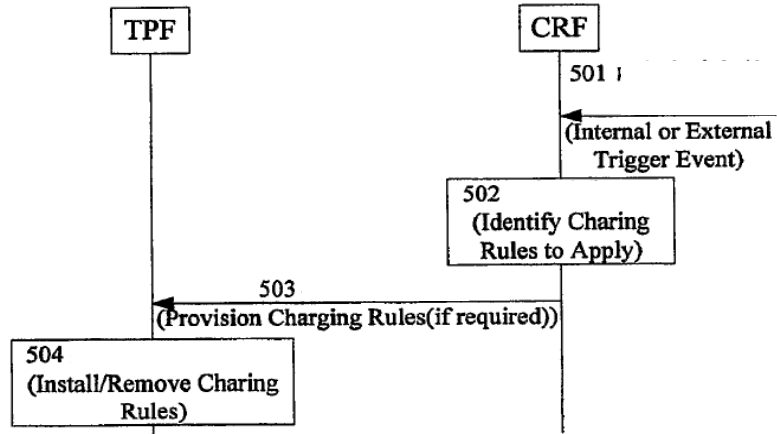

Figure 5

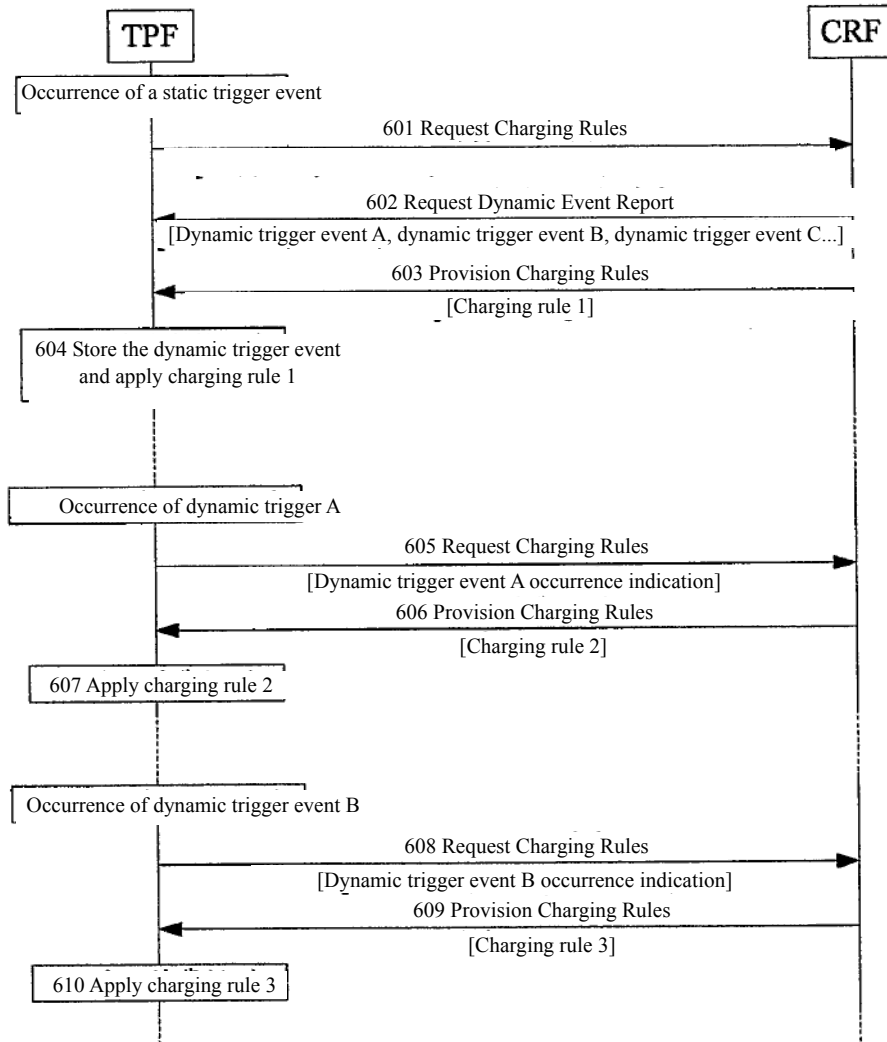

Figure 6

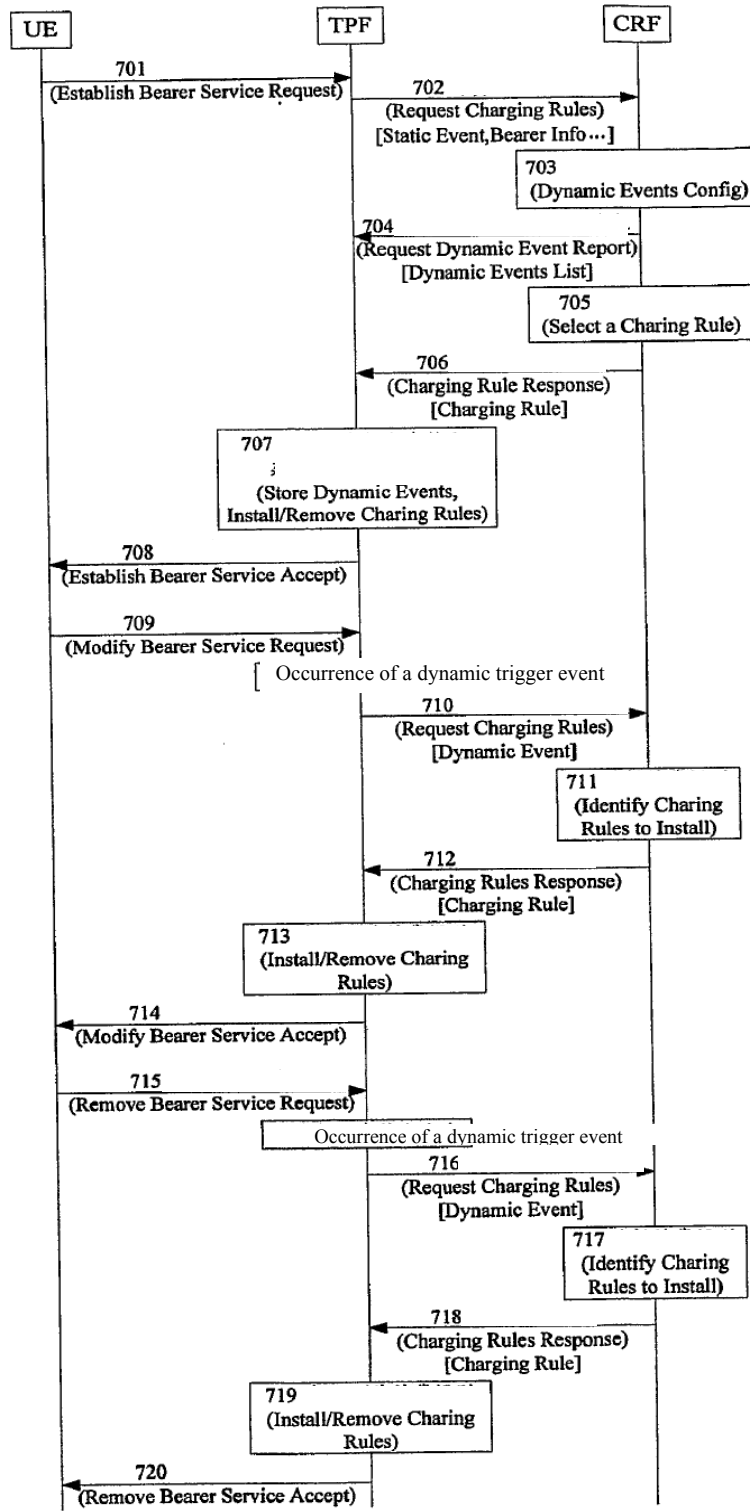

Figure 7

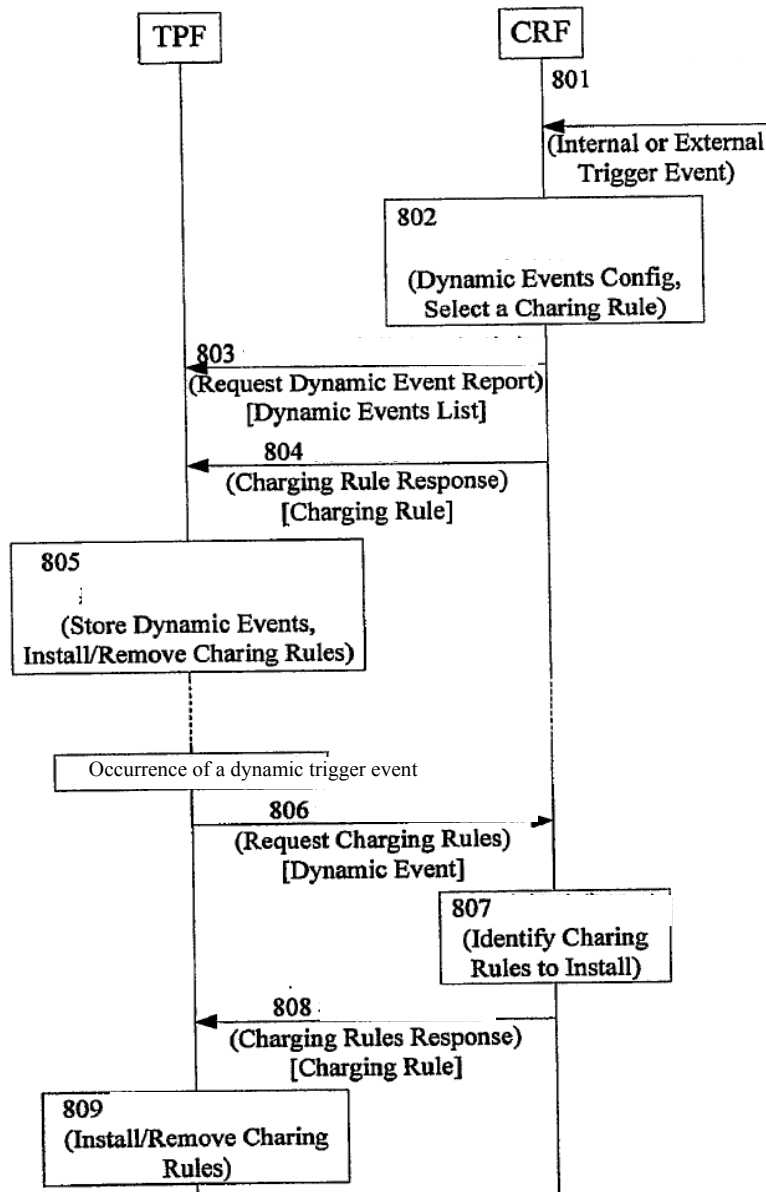

Figure 8