

Shear Stiffness and Maximum Shear Stress of Tubular Members

P.C.J. Hoogenboom and R. Spaan
 Department of Civil Engineering and Geosciences, Delft University of Technology
 Delft, The Netherlands

ABSTRACT

The shear stiffness and the maximum shear stress predicted by commonly used formulae are accurate for thin-wall tubes but too small for thick-wall tubes. New formulae for the shear stiffness and the maximum shear stress are proposed.





KEYWORDS: Shear Stiffness; Shear Stress; Tubes; Pipes; Circular Cross-Section; Frame Analysis

INTRODUCTION

Tubular members are frequently used in offshore structures. In the analysis of these structures often axial forces in the members are dominant but also moments and shear forces can be important. Obviously, the values of the member stiffnesses are needed to perform the structural analysis and compute the force flow. The values of the member section moduli are needed to check the member maximum stresses. Formulae for shear stiffnesses and maximum shear stresses are provided in text books and reference books for various cross-sections (Table 1) (Timoshenko 1970), (Hartsuiker 2000), (Blaauwendraad 2002). They have been derived analytically in various ways including the principle of minimum complementary energy. Recently, the authors studied tubular members using finite element analysis and found that the real values can be substantially larger than predicted by the formula (Spaan 2003). The formulae for thin-walled tubes were found to be accurate. However, the shear stiffness and maximum stress increase substantially with the wall thickness.

In the next section of this paper the traditional formula for the shear stiffness and maximum shear stress in round tubular members are derived. Subsequently finite element models are used to check these formulae. The finite element results on the maximum shear stress and the shear stiffness are presented. In the conclusions new formulae are proposed for the shear stiffness and maximum shear stress in round tubular members.

Table 1. Traditional shear formulae for several cross-sections

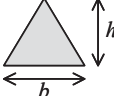
Cross-Section	Shear Stiffness GA_s	Maximum Shear Stress τ_{\max}
	$\frac{5}{6}GA$	$\frac{3}{2}\frac{V}{A}$
	$\frac{32}{37}GA$	$\frac{4}{3}\frac{V}{A}$
	$\frac{1}{2}GA$	$2\frac{V}{A}$
	GA_{web}	$\frac{15}{14}\frac{V}{A_{\text{web}}}$
	$\frac{10h^2}{12h^2 + b^2}GA$	$\frac{3}{4}\sqrt{4 + \frac{b^2}{h^2}}\frac{V}{A}$

TRADITIONAL DERIVATION OF SHEAR FORMULAE

Traditionally, the shear stiffness of a cross-section of a prismatic beam is derived by setting equal the complementary energy of a slice of the beam to the complementary energy of a slice of the wire model of the beam. This method can be used for any cross-section shape. The first step in the derivation is assuming a statically allowable stress distribution. A reasonable assumption for a thin wall tube is

$$\sigma_{x\theta} = \tau_{\max} \cos \theta, \quad (1)$$

where $\sigma_{x\theta}$ is the shear stress in the circumferential direction of the cross-section and τ_{\max} is the largest shear stress (Fig. 1). In fact it can be shown that this is the exact distribution of the shear stress using cylindrical shell theory (Timoshenko 1959)(Hoefakker 2003). The

resulting shear force V is the integral of the vertical component of the shear force $\sigma_{x\theta} t ds$ over the circumference s of the tube (Fig. 1)

$$V = \int_{s=0}^{2\pi r} \sigma_{x\theta} t ds \cos \theta, \quad (2)$$

where t is the tube thickness and ds is part of the circumference.

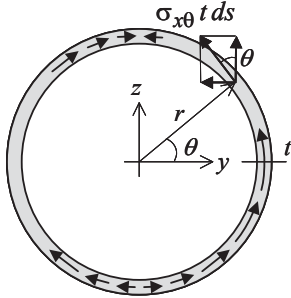

Fig. 1. Shear stress distribution and decomposition in the z direction

Substitution of (1) in (2) and evaluation gives

$$V = \tau_{\max} t r \pi. \quad (3)$$

Therefore the maximum stress can be expressed in the beam shear

$$\tau_{\max} = 2 \frac{V}{A}, \quad (4)$$

where A is the cross-section area. The complementary energy of a slice of the tube is the shear force $\sigma_{x\theta} t ds$ times the displacement $\gamma \Delta x$ over 2, integrated over the circumference s of the tube.

$$E_c = \int_{s=0}^{2\pi r} \frac{1}{2} \sigma_{x\theta} t ds \gamma \Delta x \quad (5)$$

The factor $\frac{1}{2}$ needs to be included to obtain the area above the shear force–displacement curve. Using (1), $\sigma_{x\theta} = G \gamma$ and evaluation of the complementary energy gives

$$E_c = \frac{r \Delta x t \pi \tau_{\max}^2}{2G}. \quad (6)$$

The complementary energy of the wire model is the area over the load–displacement diagram (Fig. 2).

$$E_c = \frac{1}{2} V \gamma \Delta x. \quad (7)$$

The constitutive equation is

$$V = GA_s \gamma, \quad (8)$$

where GA_s is the wire model shear stiffness and γ is the wire model shear deformation. In fact the constitutive equation gives the definition of the shear stiffness. Substituting (8) in (7) gives

$$E_c = \frac{1}{2} \frac{V^2}{GA_s} \Delta x. \quad (9)$$

The complementary energy of the tube slice is equal to the complementary energy of the wire model slice.

$$\frac{r \Delta x t \pi \tau_{\max}^2}{2G} = \frac{1}{2} \frac{V^2}{GA_s} \Delta x \quad (10)$$

From this (4) and $A = 2\pi r t$ we solve the shear stiffness

$$GA_s = \frac{1}{2} GA \quad (11)$$

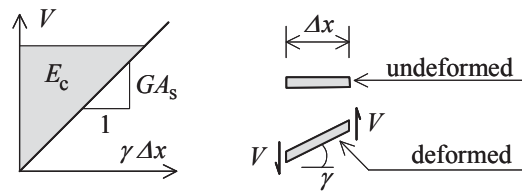

Fig. 2. Complementary energy of a wire model part

FINITE ELEMENT MODEL

The finite element analyses are performed on a cylindrical tube with a length of 1000 mm and an outer radius of 100 mm. The tube ends are loaded by concentrated forces, which result in a constant shear force over the length (Fig. 3). In the middle section the moment is zero.¹ The loading is in perfect equilibrium.

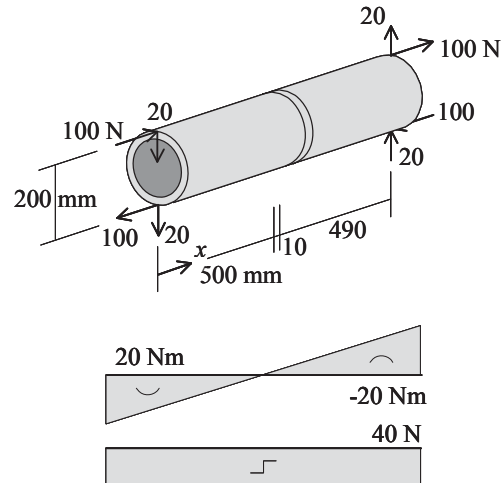

Fig. 3. Tube loading, moment diagram and shear force diagram

¹ This prevents any influence of the moment on the calculated shear stiffness. However, this might be an unnecessary precaution because analyses of rectangular cross-sections showed that the presence of a moment does not influence the shear stiffness (Van der Meer 2003).

In a tube of this length the peak stresses due to the loading applied at the ends will have disappeared in the middle cross-section. The tube is supported in the middle section such that the deformation is not restrained and only rigid body translations and rotations are prevented. Clearly all support reactions will be zero.

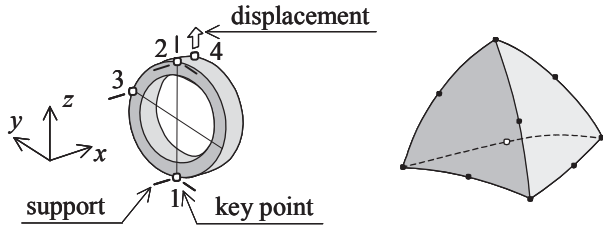

Fig. 4. Tube support at the middle slice and the applied element type

The finite element analysis are performed with ANSYS (2004) on models with a wall thickness of 5, 7.5, 10, 20, 30, 40, 50, 60, 70, 80, 90 mm and a solid model. The models consist of tetrahedron elements (SOLID92) with each 10 nodes (Fig. 4, 5). Young's modulus is $E = 2.1 \cdot 10^5 \text{ N/mm}^2$ and Poisson's ratio is $\nu = 0.30$. The model is supported in the middle section at key points 1, 2 and 3 (Fig. 4). $u_{x1} = u_{y1} = u_{x2} = u_{y2} = u_{z2} = u_{x3} = 0$.

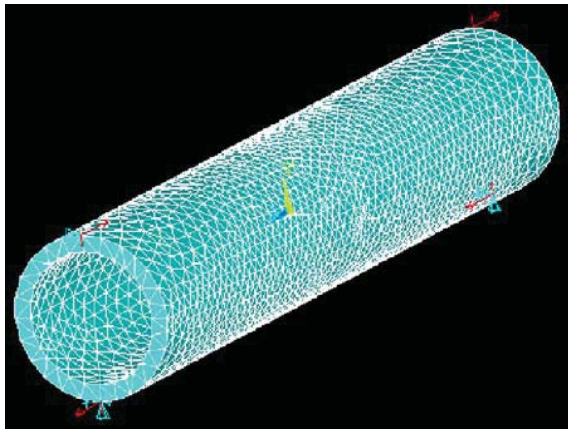

Fig. 5. Finite element model of the tube with 20 mm wall thickness

MAXIMUM SHEAR STRESS

In Figure 6 the maximum shear stress is plotted as a function of the wall thickness. It occurs around the inner surface of the tube (Fig. 7). This peak stress increases with the wall thickness and disappears in a solid section.

In this model the mesh would need to be very dense, which was not possible due to the maximum number of elements and restricted computation time. A straight line can be drawn through the results representing the following function.

$$\frac{\tau_{\max} A}{V} = 2 + \frac{t}{r} \quad (15)$$

For a solid section the maximum shear stress is

$$\tau_{\max} = \frac{3}{2} \frac{V}{A}, \quad (16)$$

which is 13% larger than predicted by the traditional formula (Table 1).

When the tube inner diameter is very small compared to the outer diameter the situation resembles a cylindrical hole in an infinite continuum. The finite element results indicate that in this situation the maximum shear stress is two times the uniform shear stress at some distance of the hole. After all, without hole the maximum stress is $1.5 V/A$ and with the small hole it is $3 V/A$. Stress concentrations around cylindrical holes in infinite continua are studied thoroughly in the elasticity theory. However, for this particular situation the authors could not find analytical results. Nonetheless, it is expected that an analytical solution can be derived that will confirm the finite element results.

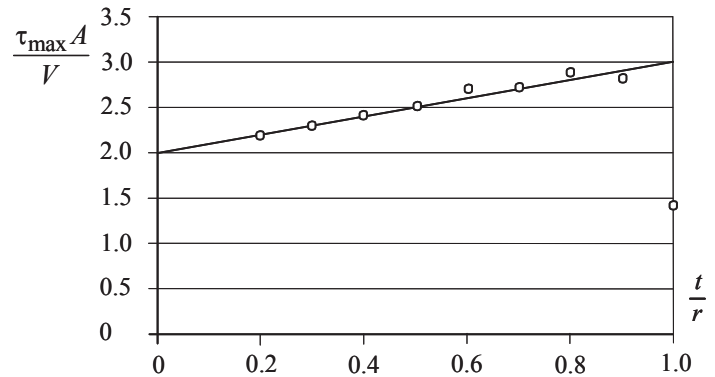

Fig. 6. Maximum shear stress as a function of the wall thickness (The dots are the FEM results and the line is the design formula)

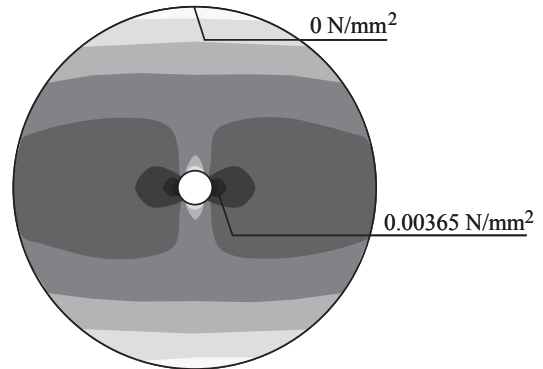

Fig. 7. Shear stress distribution in the middle slice of the tube with 90 mm wall thickness

SHEAR STIFFNESS

The shear deformation of the middle slide is (Fig. 4).

$$\gamma = \frac{u_z 4}{\Delta x} \quad (17)$$

where Δx is the slice thickness and u_{z4} is the displacement of key point 4 in the z direction. The shear stiffness is defined as

$$GA_s = \frac{V}{\gamma} \quad (18)$$

Substituting (17) in (18) we obtain

$$GA_s = \frac{V \Delta x}{u_{z4}} \quad (19)$$

where $V = 40$ N and $\Delta x = 10$ mm.

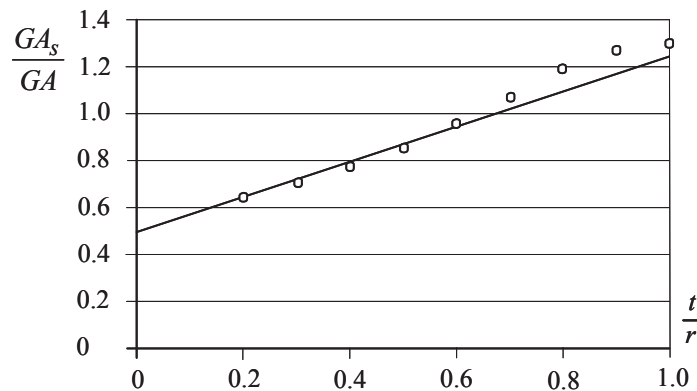

Fig. 8. Shear stiffness as a function of the wall thickness (The dots are the FEM results and the line is the design formula)

In Figure 8 the shear stiffness is plotted as a function of the wall thickness. A straight line has been drawn through the results representing the following function.

$$\frac{GA_s}{GA} = \frac{1}{2} + \frac{3}{4} \frac{t}{r} \quad (20)$$

CONCLUSIONS

Traditionally the following formulae are used for the shear stiffness GA_s and largest shear stress τ_{\max} of circular tubes.

$$GA_s = \frac{1}{2} GA \quad (21)$$

$$\tau_{\max} = 2 \frac{V}{A} \quad (22)$$

Where G is the material shear modulus, A is the cross-section area and V is the shear force.

It was found that these formulae are only accurate for thin walled tubes. For example in a 200 mm diameter tube with a wall thickness of 20 mm the shear stress is 10% larger than predicted by the latter formula. Therefore the following formulae are proposed which are also valid for thick walls.

$$GA_s = \left(\frac{1}{2} + \frac{3}{4} \frac{t}{r}\right) GA \quad 0 \leq t \leq r \quad (23)$$

$$\tau_{\max} = \left(2 + \frac{t}{r}\right) \frac{V}{A} \quad 0 \leq t < r \quad (24)$$

Where r is the tube outer radius and t is the wall thickness. It is noted that the shear stress formula is not valid for solid cross-sections ($t = r$)

because than the maximum shear stress drops to $\tau_{\max} = \frac{3}{2} \frac{V}{A}$.

The computed shear stiffness and the maximum shear stress of solid round sections are 44% and 13% larger than predicted by the traditional formulae.

LITERATURE

- ANSYS (2004), finite element program, online <http://www.ansys.com>.
- Barber JR (1992), "Elasticity", *Kluwer Academic Publishers*.
- Case J, Chilver L, Ross CTF (1999), "Strength of Materials and Structures", 4th Edition, *Elsevier*.
- Blaauwendraad J (2002), "Theory of Elasticity", Lecture book, *Delft University of Technology*.
- Hartsuiker C (2000), "Strength of Materials (Toegepaste Mechanica), Part 2", *Academic Service*, Schoonhoven, ISBN 9039505942 (In Dutch).
- Hoefakker JH, Blaauwendraad J (2003), "Theory of Shells", Lecture book, *Delft University of Technology*.
- Spaan R (2003), "Afschuifstijfheid van ronde doorsneden", "Shear Stiffness of Circular Cross-Sections", B.Sc. project report, *Delft University of Technology* (in Dutch) online http://www.mechanics.citg.tudelft.nl/graduation/BSc_projects.htm
- Timoshenko S, Woinowsky-Krieger S (1959), "Theory of Plates and Shells", *Mc Graw Hill*, New York.
- Timoshenko SP, Goodier JN (1970), "Theory of Elasticity", *Mc Graw Hill* Singapore, third edition.
- Van der Meer JM (2003), "Shear stiffness of beams and columns (Afschuifstijfheid van liggers en kolommen)", B.Sc. project report, *Delft University of Technology*, (In Dutch), online http://www.mechanics.citg.tudelft.nl/graduation/BSc_projects.htm