



US005990927A

United States Patent [19]
Hendricks et al.

[11] **Patent Number:** **5,990,927**
[45] **Date of Patent:** **Nov. 23, 1999**

[54] **ADVANCED SET TOP TERMINAL FOR CABLE TELEVISION DELIVERY SYSTEMS**

OTHER PUBLICATIONS

[75] Inventors: **John S. Hendricks**, Potomac; **Alfred E. Bonner**, Bethesda, both of Md.; **Richard E. Wunderlich**, Alpharetta; **Eric C. Berkobin**, Woodstock, both of Ga.

Hong Kong Enterprise advertisement: Two Innovative New Consumer Products From SVI; Nov. 1988, p. 379.

Great Presentations advertisement: Remote, Remote; 1987; p. 32H.

Consumer Dist. advertisement: Xpand Your TV's Channel Capability; Fall/Winter 1992; p. 215.

[73] Assignee: **Discovery Communications, Inc.**, Bethesda, Md.

Henrie van den Boom: An Interactive Videotex System for Two-Way CATV Networks; AEU, Band 40; 1986; pp. 397-401.

[21] Appl. No.: **08/160,194**

Daniel M. Moloney: Digital Compression in Today's Addressable Environment; 1993 NCTA Technical Papers; Jun. 6, 1993; pp. 308-316.

[22] Filed: **Dec. 2, 1993**

(List continued on next page.)

Related U.S. Application Data

Primary Examiner—Chris Grant

Attorney, Agent, or Firm—Dorsey & Whitney LLP

[63] Continuation-in-part of application No. 07/991,074, Dec. 9, 1992.

[51] **Int. Cl.**⁶ **H04N 7/16**

[52] **U.S. Cl.** **348/6; 348/10; 455/6.2; 455/6.3**

[58] **Field of Search** 348/10, 11, 6, 348/7, 12, 13, 578, 584, 589, 906; 455/5.1, 6.1, 4.2, 6.2, 6.3; H04N 7/16, 7/173

[57] **ABSTRACT**

A novel advanced set top terminal capable of digital decompression, menu generation, interactivity and other advanced functional capabilities for use in a television program delivery system is described. The invention relates to methods and apparatus for upgrading existing set top terminals to provide menu generation capability and advanced functional capabilities. The invention is particularly useful in television program delivery systems with hundreds of channels of programming, providing (i) menu driven program selection through the addition of an upgrade module or menu generation card and (ii) advanced functional capabilities using a set of hardware upgrades and/or an expansion card. Specifically, the invention is an upgradeable system that supports advanced set top functionality through the use of internal software, hardware upgrades, an upgrade module and/or expansion cards. The upgraded hardware generally includes a microprocessor, various input/output ports, processing circuitry and memory. The invention results in an upgraded set top terminal that supports: menu generation; picture-on-picture displays; program catalogue services; interactive services; telephone caller identification; digital audio reception; VCR control; HDTV reception; and backyard satellite system interoperability, among other features and capabilities.

[56] **References Cited**

U.S. PATENT DOCUMENTS

- D. 301,037 5/1989 Matsuda .
- D. 314,383 2/1991 Hafner .
- D. 325,581 4/1992 Schwartz .

(List continued on next page.)

FOREIGN PATENT DOCUMENTS

- 2044574 12/1992 Canada .
- 149536 1/1984 European Pat. Off. .
- 103438 3/1984 European Pat. Off. .
- 145063 6/1985 European Pat. Off. .
- 158548 10/1985 European Pat. Off. .
- 167237 1/1986 European Pat. Off. .

(List continued on next page.)

35 Claims, 32 Drawing Sheets

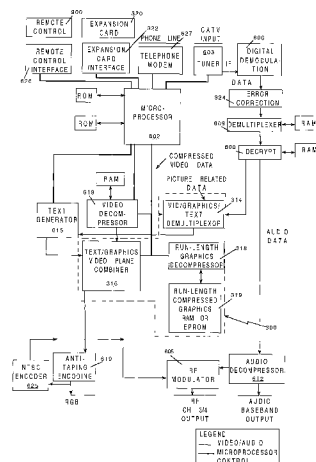

U.S. PATENT DOCUMENTS

D. 329,238	9/1992	Grasso et al. .	5,343,239	8/1994	Lappington et al. .
D. 331,760	12/1992	Renk, Jr. .	5,345,594	9/1994	Tsuda .
4,361,848	11/1982	Poignet et al. .	5,349,638	9/1994	Pitroda et al. .
4,398,216	8/1983	Field et al. .	5,351,075	9/1994	Herz et al. .
4,488,179	12/1984	Kruger et al. .	5,353,121	10/1994	Young et al. .
4,517,598	5/1985	Van Valkenburg et al. .	5,355,162	10/1994	Yazolino et al. .
4,587,520	5/1986	Astle .	5,357,276	10/1994	Banker et al. 348/7
4,621,282	11/1986	Ahern .	5,365,265	11/1994	Shibata et al. .
4,633,462	12/1986	Stifle et al. .	5,367,571	11/1994	Bowen et al. 348/10
4,688,246	8/1987	Eilers et al. .	5,390,348	2/1995	Magin et al. .
4,697,209	9/1987	Kiewit et al. .	5,396,546	3/1995	Remillard .
4,706,121	11/1987	Young .	5,400,401	3/1995	Wasilewski et al. .
4,712,105	12/1987	Kohler .	5,404,393	4/1995	Remillard .
4,712,130	12/1987	Casey 348/566	5,404,505	4/1995	Levinson .
4,724,491	2/1988	Lambert .	5,410,326	4/1995	Goldstein .
4,792,972	12/1988	Cook, Jr. .	5,412,416	5/1995	Nemirofsky .
4,829,558	5/1989	Welsh .	5,414,426	5/1995	O'Donnell et al. .
4,860,379	8/1989	Schoeneberger et al. .	5,416,508	5/1995	Sakuma et al. .
4,876,736	10/1989	Kiewit .	5,440,632	8/1995	Bacon et al. .
4,947,429	8/1990	Bestler et al. .	5,442,626	8/1995	Wei .
4,949,187	8/1990	Cohen .	5,446,919	8/1995	Wilkins .
4,959,810	9/1990	Darbee et al. .	5,461,667	10/1995	Remillard .
4,961,109	10/1990	Tanaka .	5,469,206	11/1995	Strubbe et al. .
4,975,951	12/1990	Bennett .	5,477,263	12/1995	O'Callaghan et al. .
4,977,455	12/1990	Young .	5,479,268	12/1995	Young et al. .
4,995,078	2/1991	Monslow et al. .	5,481,294	1/1996	Thomas et al. .
5,001,554	3/1991	Johnson et al. .	5,481,296	1/1996	Craquon et al. .
5,014,125	5/1991	Pocock et al. .	5,481,542	1/1996	Logston et al. .
5,015,829	5/1991	Eilert et al. .	5,483,278	1/1996	Strubbe et al. .
5,020,129	5/1991	Martin et al. .	5,515,098	5/1996	Carles .
5,027,400	6/1991	Baji et al. .	5,561,708	10/1996	Remillard .
5,036,394	7/1991	Morii et al. .	5,561,709	10/1996	Remillard .
5,038,402	8/1991	Robbins .	5,644,354	7/1997	Thompson et al. .
5,046,093	9/1991	Wachob .	5,663,757	9/1997	Morales .
5,047,867	9/1991	Strubbe et al. .			
5,056,138	10/1991	Tyson, Sr. .			
5,077,607	12/1991	Johnson et al. .			
5,078,019	1/1992	Aoki .			
5,093,718	3/1992	Hoarty et al. .			
5,103,314	4/1992	Keenan .			
5,105,268	4/1992	Yamanouchi .			
5,132,789	7/1992	Ammon et al. .			
5,132,992	7/1992	Yurt et al. .			
5,133,079	7/1992	Ballantyne et al. .			
5,144,663	9/1992	Kudelski et al. .			
5,150,118	9/1992	Finkle et al. .			
5,151,782	9/1992	Ferraro .			
5,151,789	9/1992	Young .			
5,166,886	11/1992	Molnar et al. .			
5,172,413	12/1992	Bradley et al. .			
5,182,639	1/1993	Jutamulia et al. .			
5,202,817	4/1993	Koenck et al. .			
5,223,924	6/1993	Strubbe .			
5,237,311	8/1993	Mailey et al. .			
5,237,610	8/1993	Gammie 380/10			
5,247,347	9/1993	Litteral et al. .			
5,253,066	10/1993	Vogel .			
5,253,275	10/1993	Yurt et al. .			
5,260,778	11/1993	Kauffman et al. .			
5,282,028	1/1994	Johnson et al. .			
5,283,639	2/1994	Esch et al. .			
5,285,272	2/1994	Bradley et al. .			
5,289,271	2/1994	Watson .			
5,293,540	3/1994	Trani et al. .			
5,293,633	3/1994	Robbins .			
5,319,455	6/1994	Hoarty et al. .			
5,319,707	6/1994	Wasilewski et al. .			
5,327,554	7/1994	Palazzi, III et al. .			
5,339,315	8/1994	Maeda et al. .			
5,341,474	8/1994	Gelman .			

FOREIGN PATENT DOCUMENTS

243312	10/1987	European Pat. Off. .
355697	2/1990	European Pat. Off. .
402809	12/1990	European Pat. Off. .
420123	4/1991	European Pat. Off. .
424648	5/1991	European Pat. Off. .
506435	9/1992	European Pat. Off. .
61-060150	3/1986	Japan .
1-20454	1/1989	Japan .
1130683	5/1989	Japan .
1142918	5/1989	Japan .
3114375	5/1991	Japan .
5250106	9/1993	Japan .
2168227	6/1986	United Kingdom .
8601962	3/1986	WIPO .
8909528	10/1989	WIPO .
9100670	1/1991	WIPO .
9103112	3/1991	WIPO .
9211713	7/1992	WIPO .
9212599	7/1992	WIPO .
9217027	10/1992	WIPO .
9221206	11/1992	WIPO .
9322877	11/1993	WIPO .

OTHER PUBLICATIONS

Caitlin Bestler: Flexible Data Structures and Interface Rituals For Rapid Development of OSD Applications; 93 NCTA Tech. Papers; Jun. 6, 1993 pp. 223-236.

A.D. Gelman, et al.: A Store-And-Forward Architecture For Video-On-Demand Service; ICC 91 Conf.; Jun. 1991; pp. 842-846.

Olshansky et al., Subscriber Distribution Networks Using Compressed Digital Video, Journal of Lightwave Technology, Nov. 1992, pp. 1760-1765.

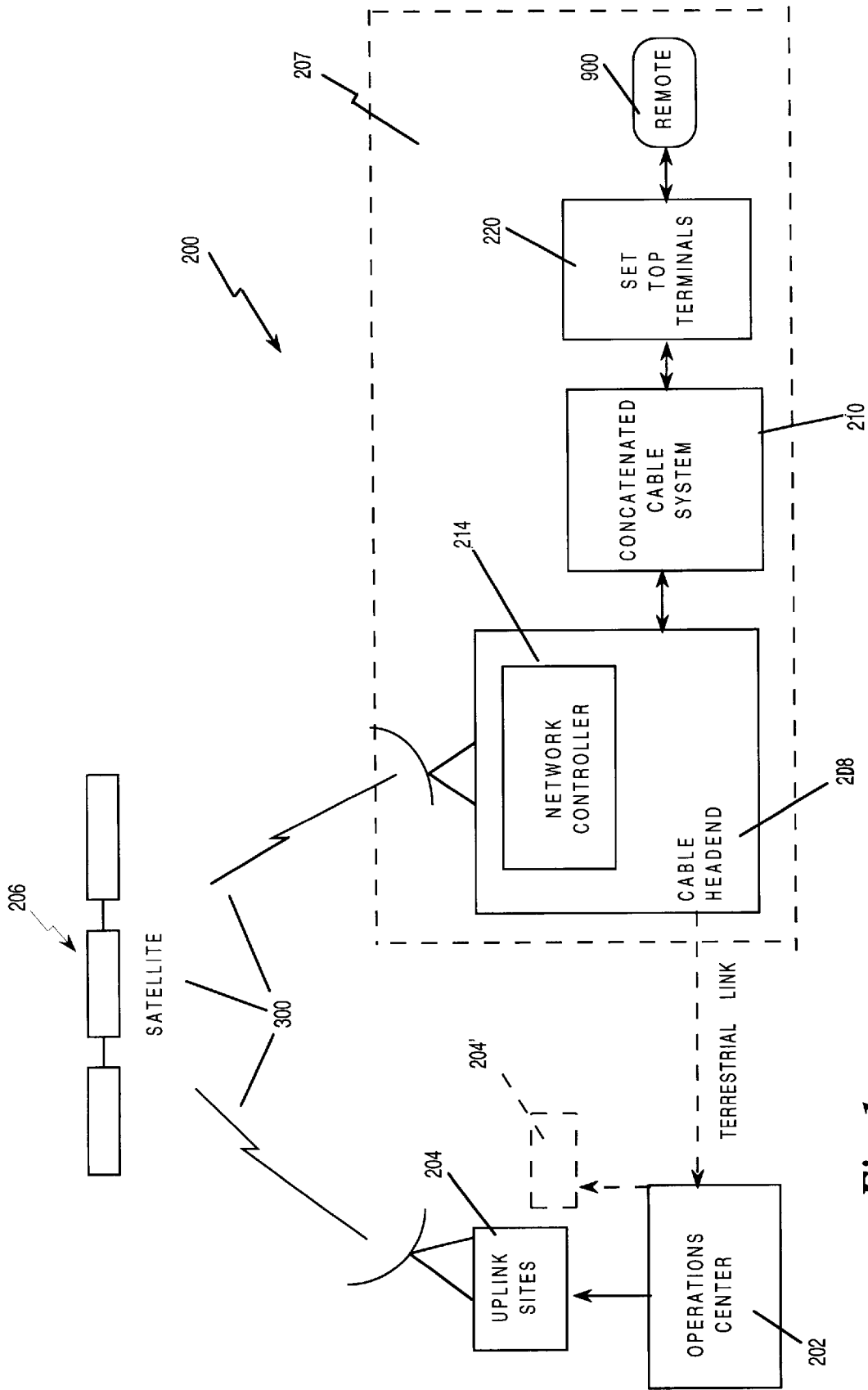

Fig. 1

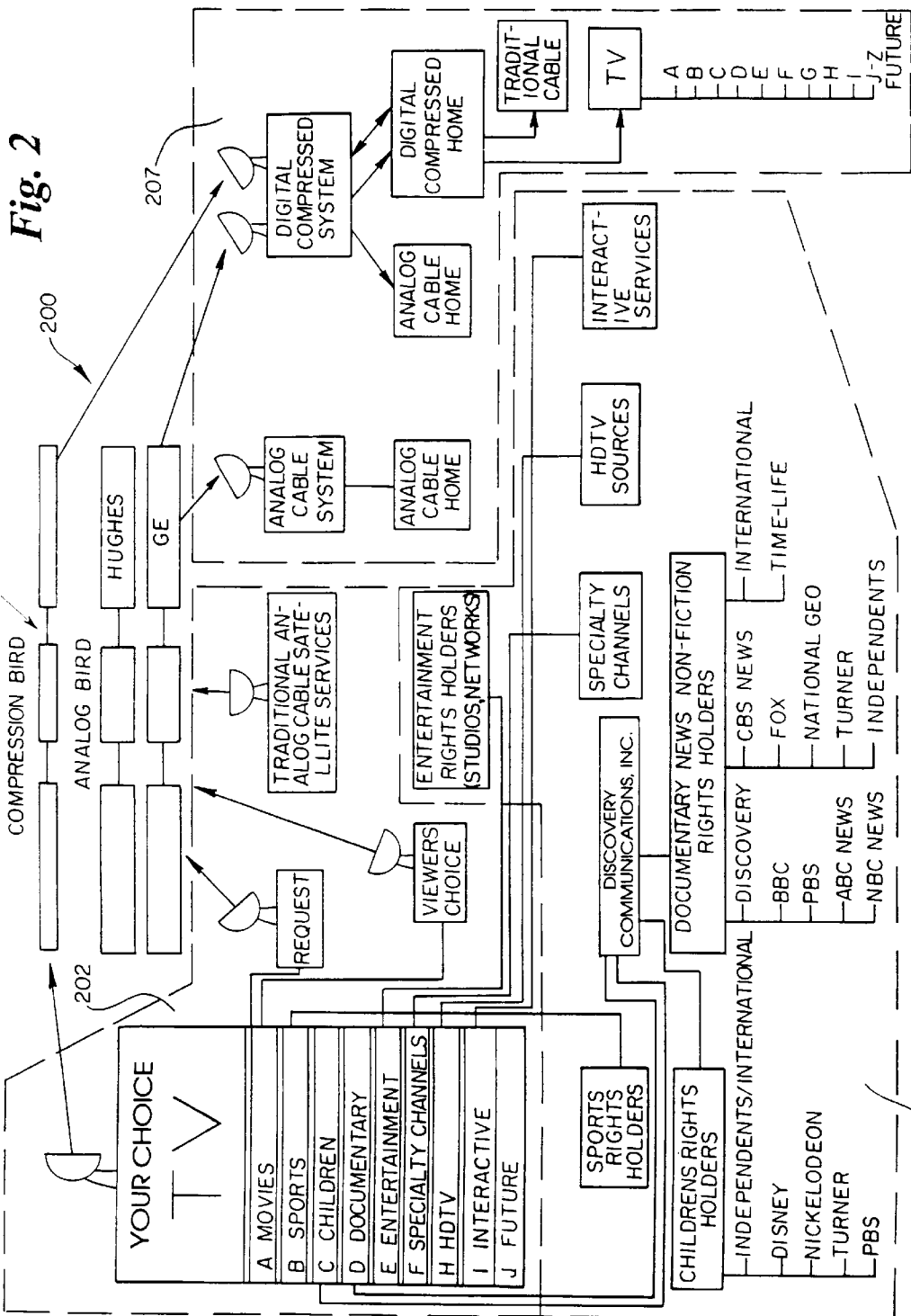
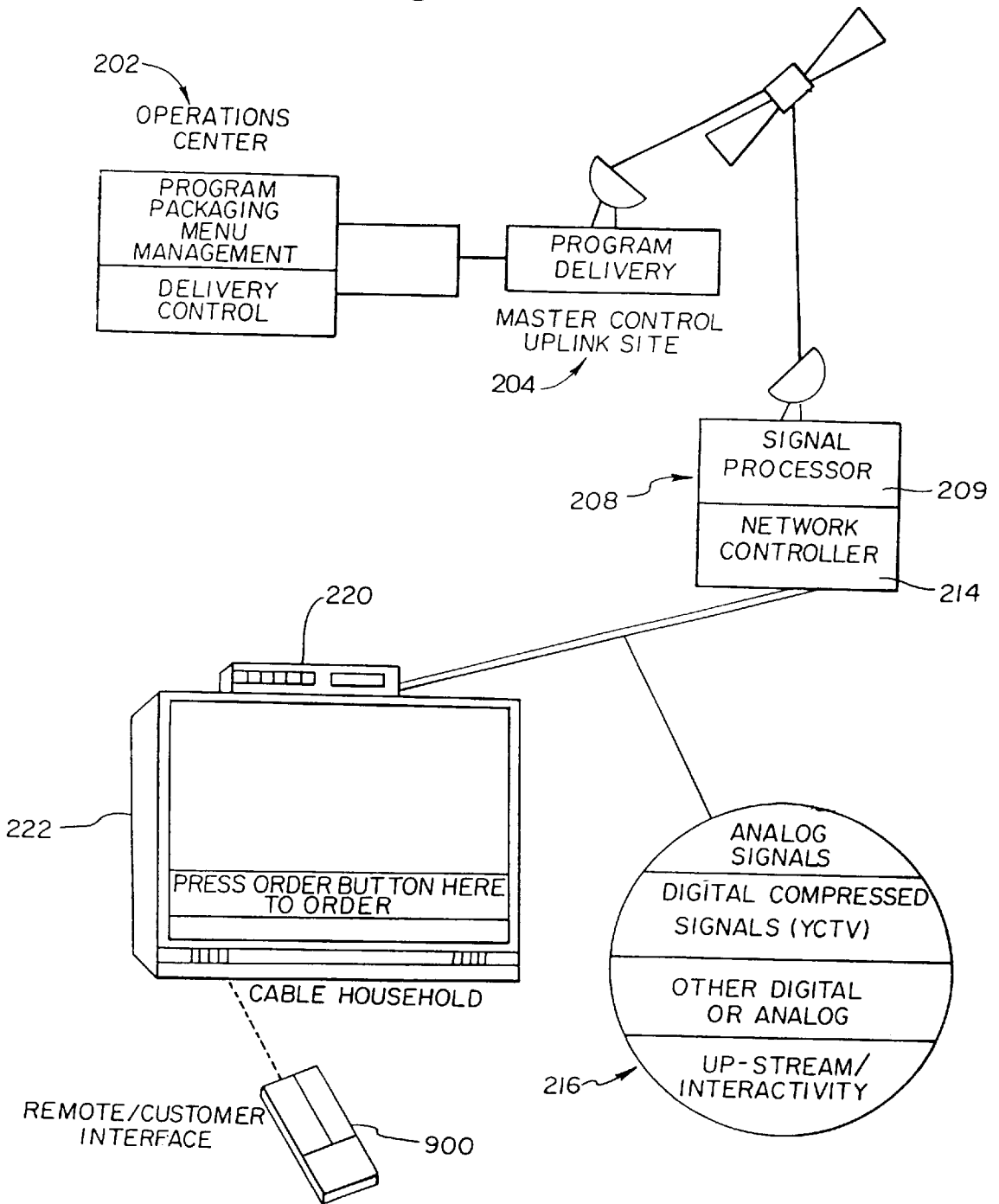

Fig. 3



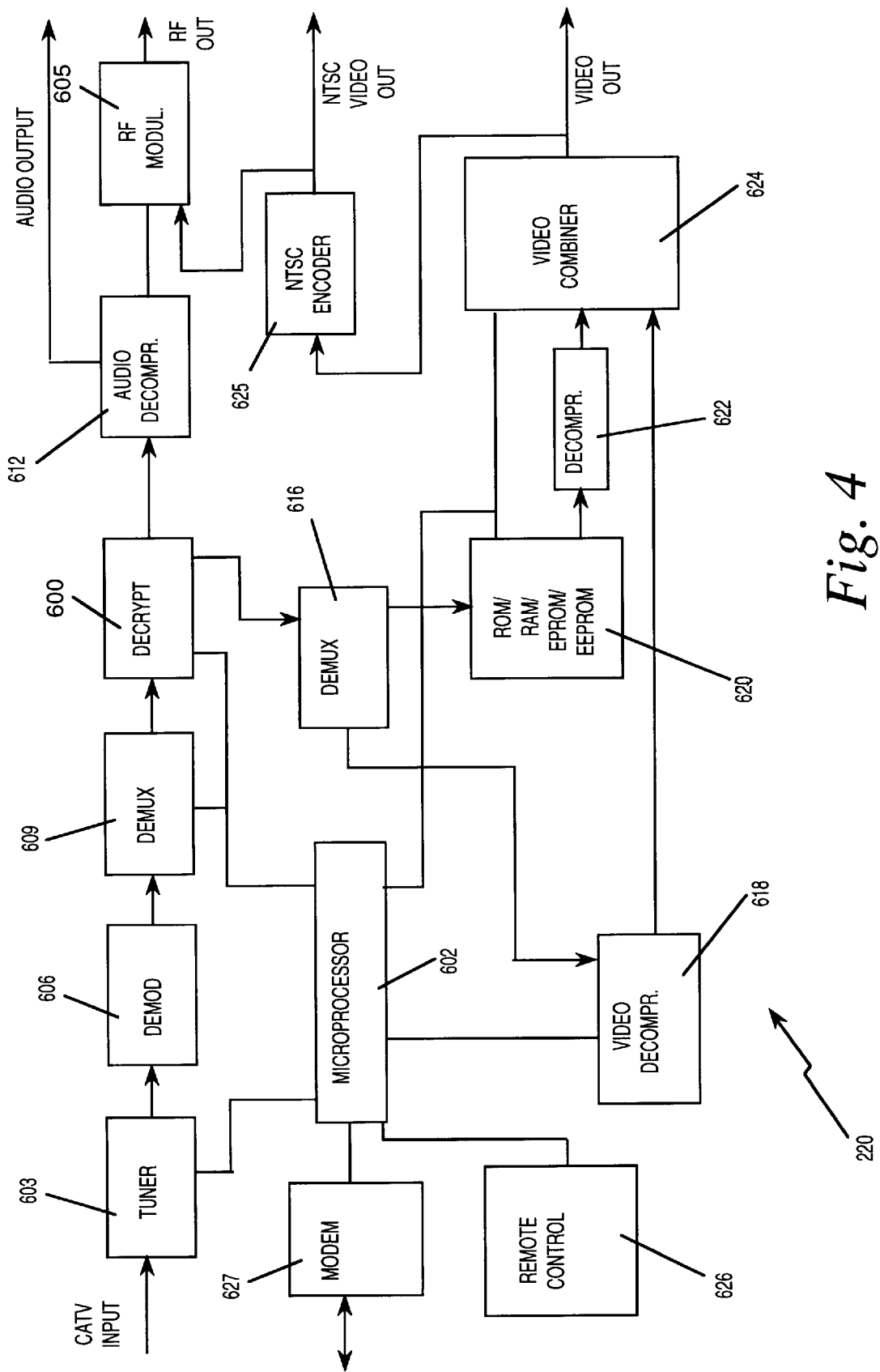

Fig. 4

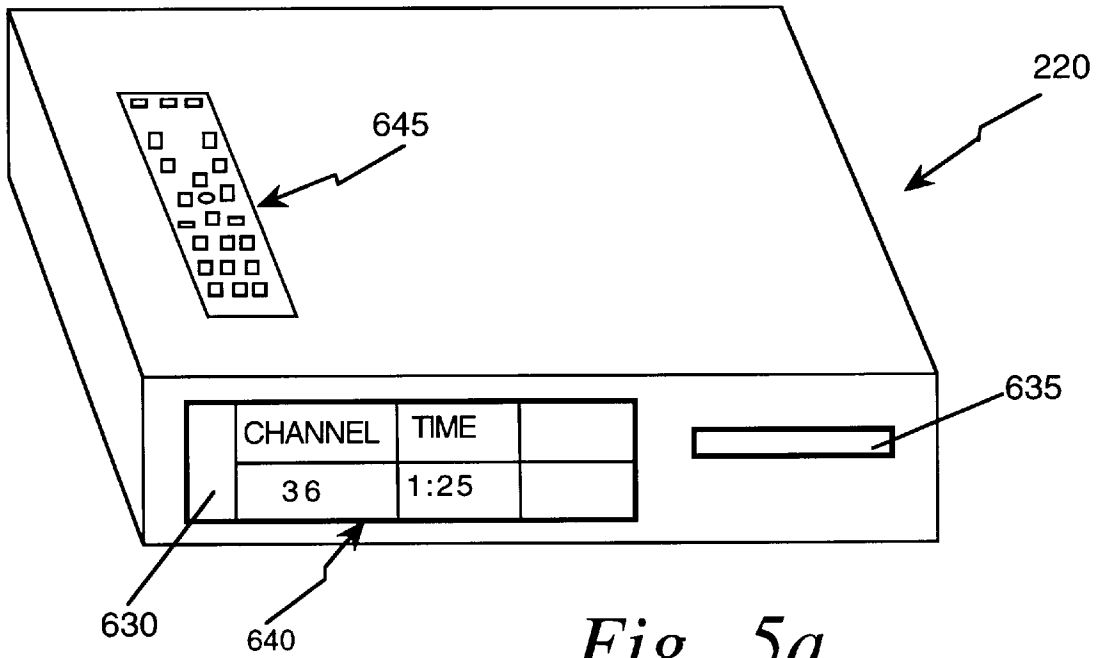

Fig. 5a

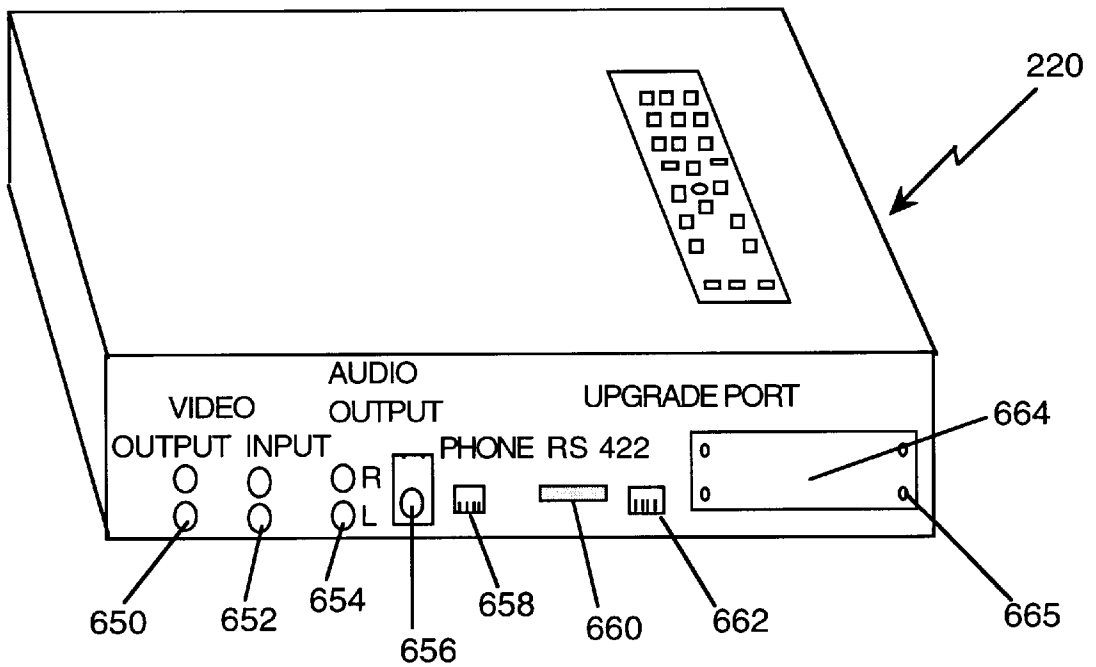

Fig. 5b

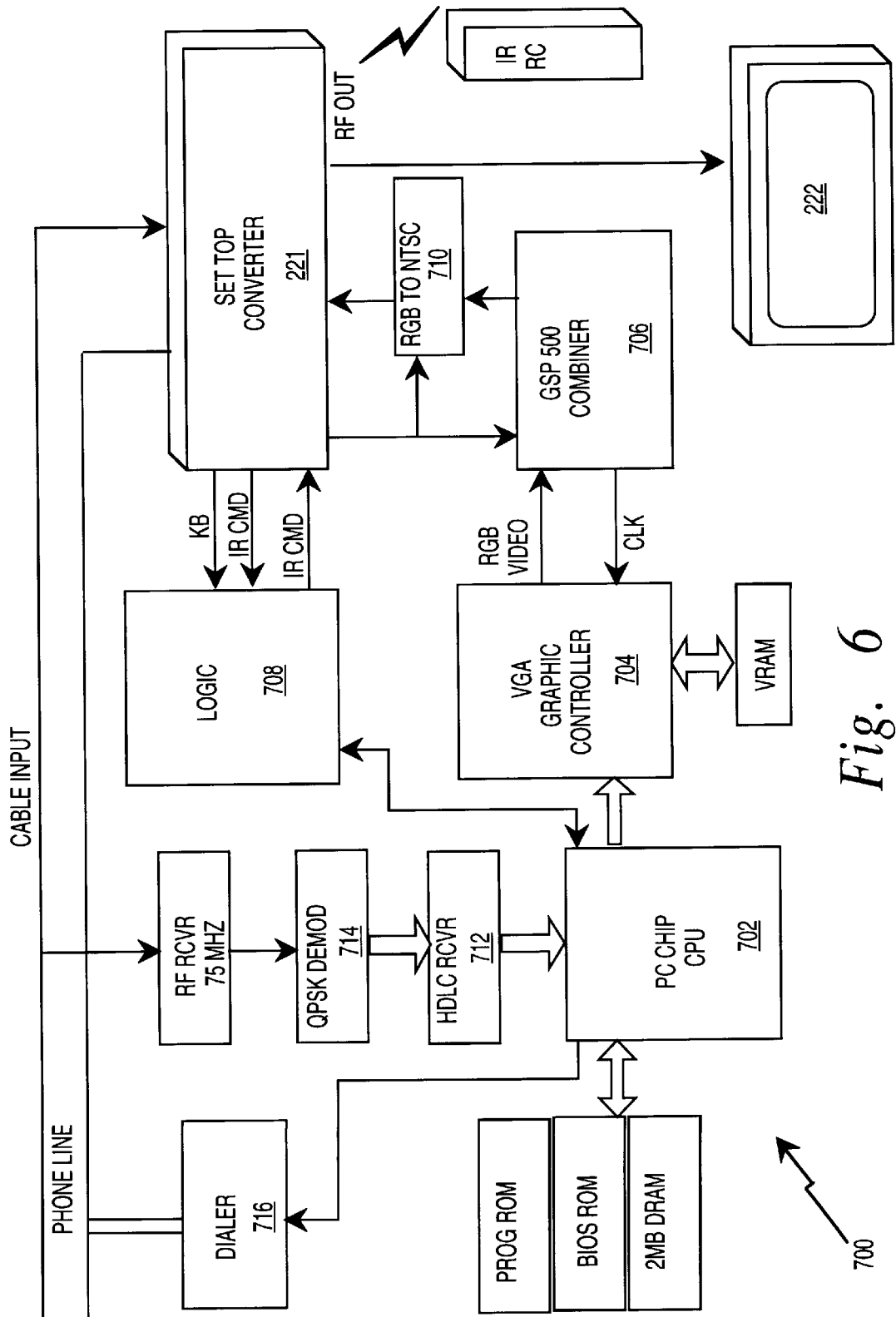

Fig. 6

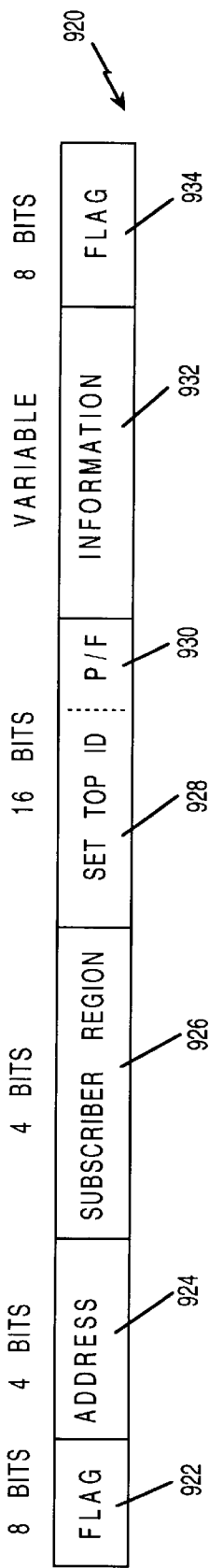

Fig. 7a

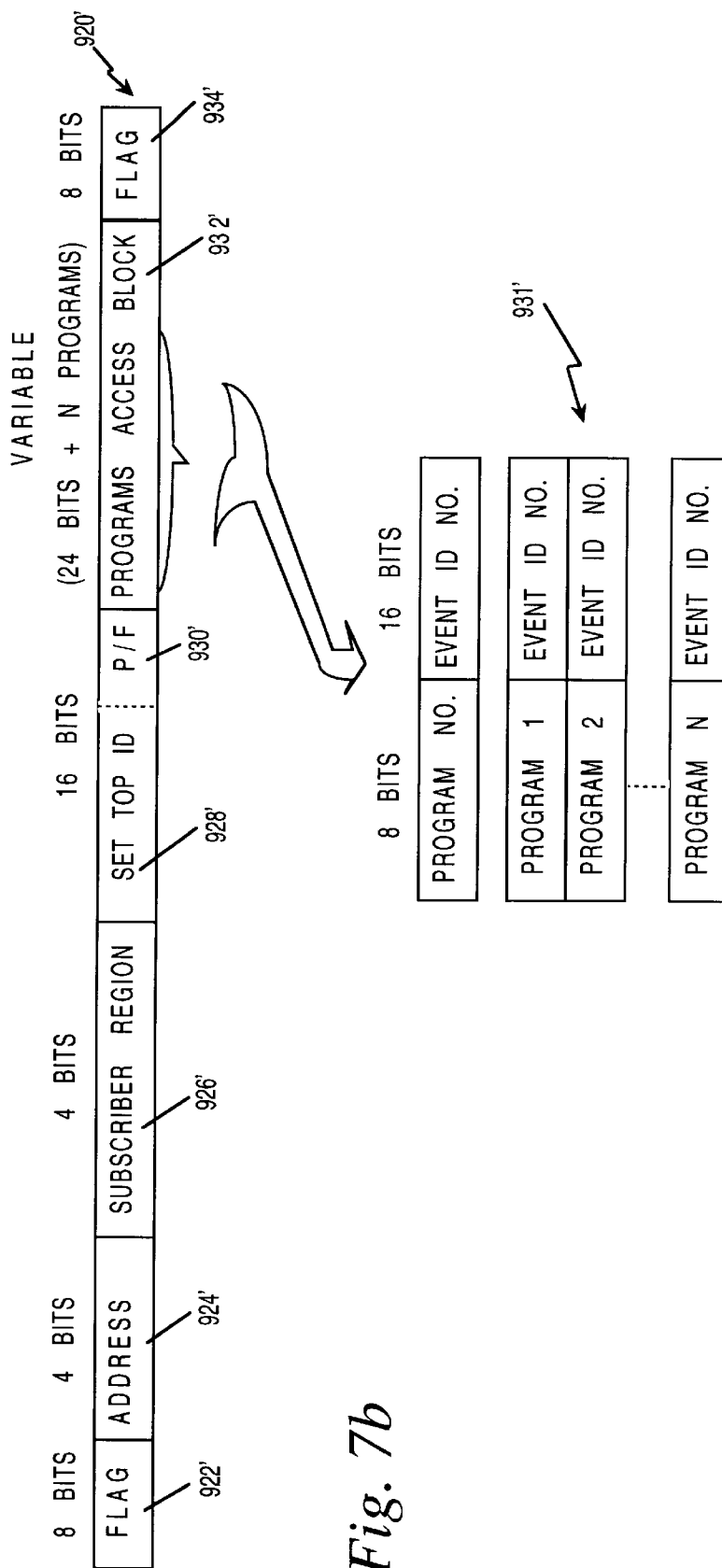

Fig. 7b

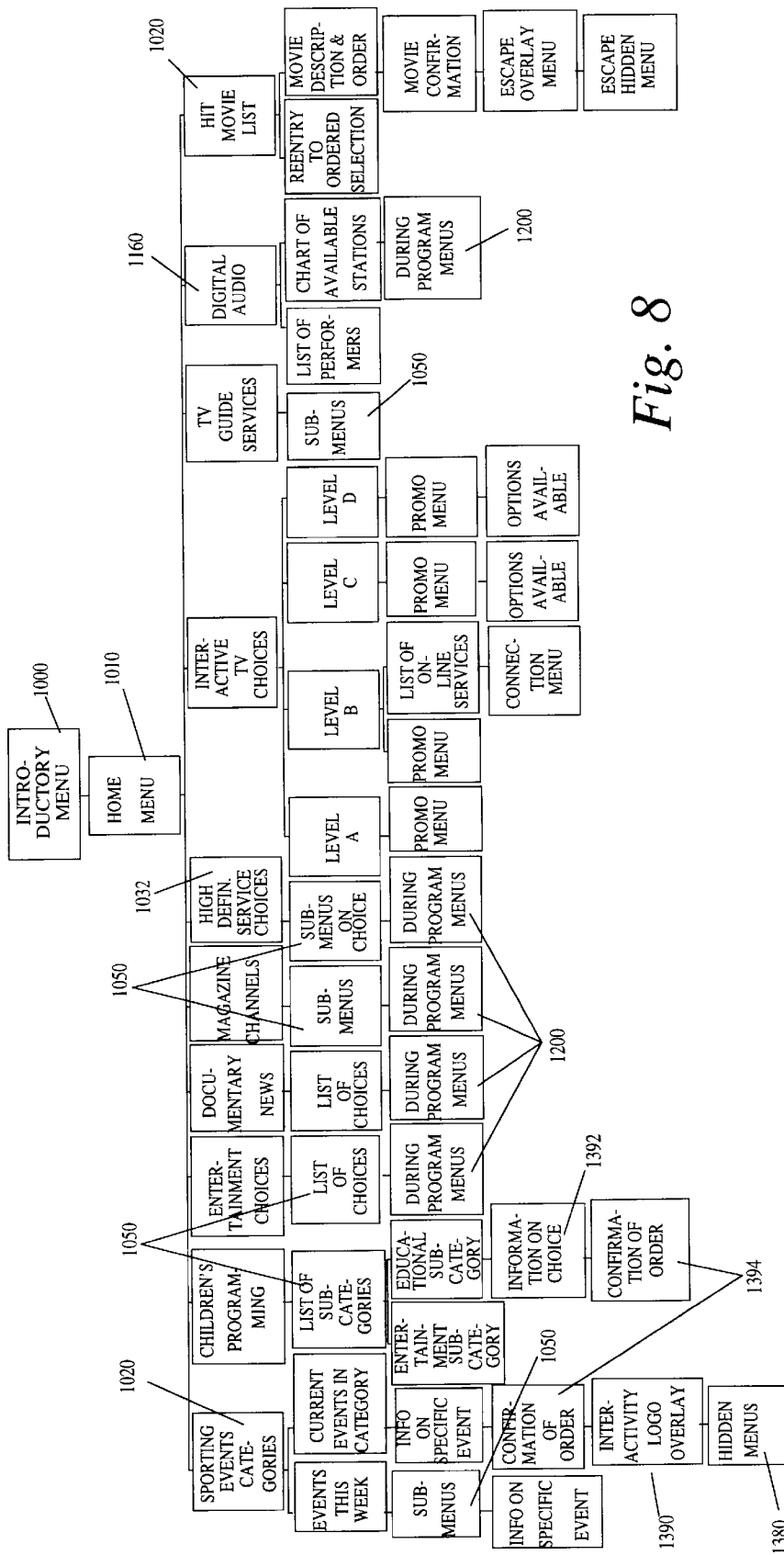

Fig. 8

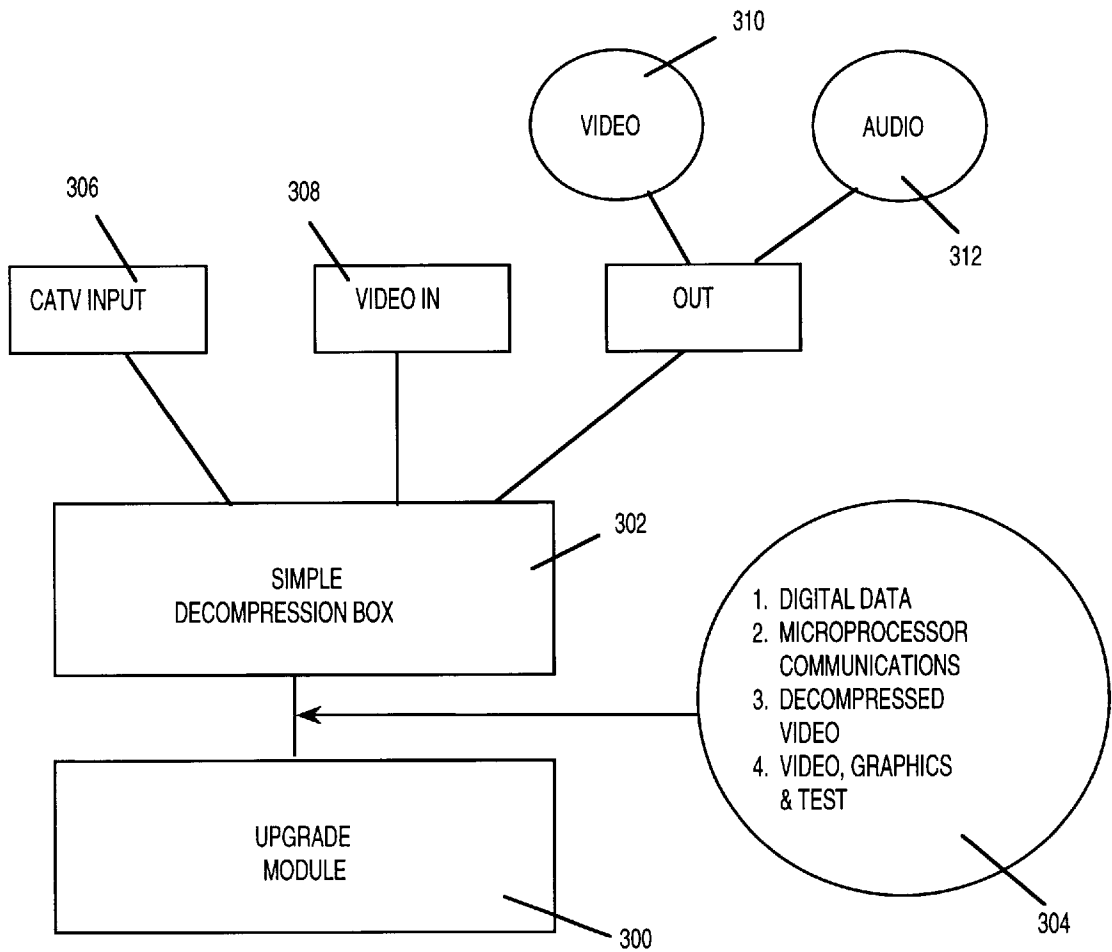

Fig. 9a

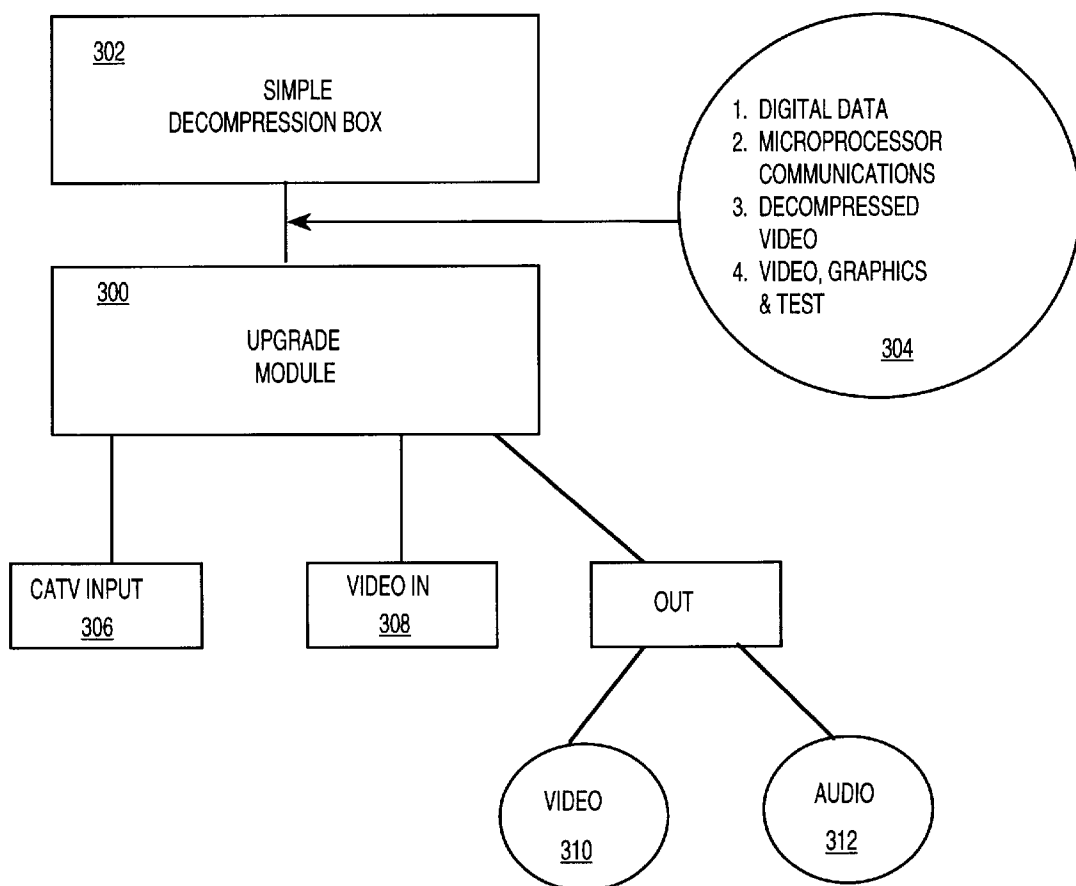

Fig. 9b

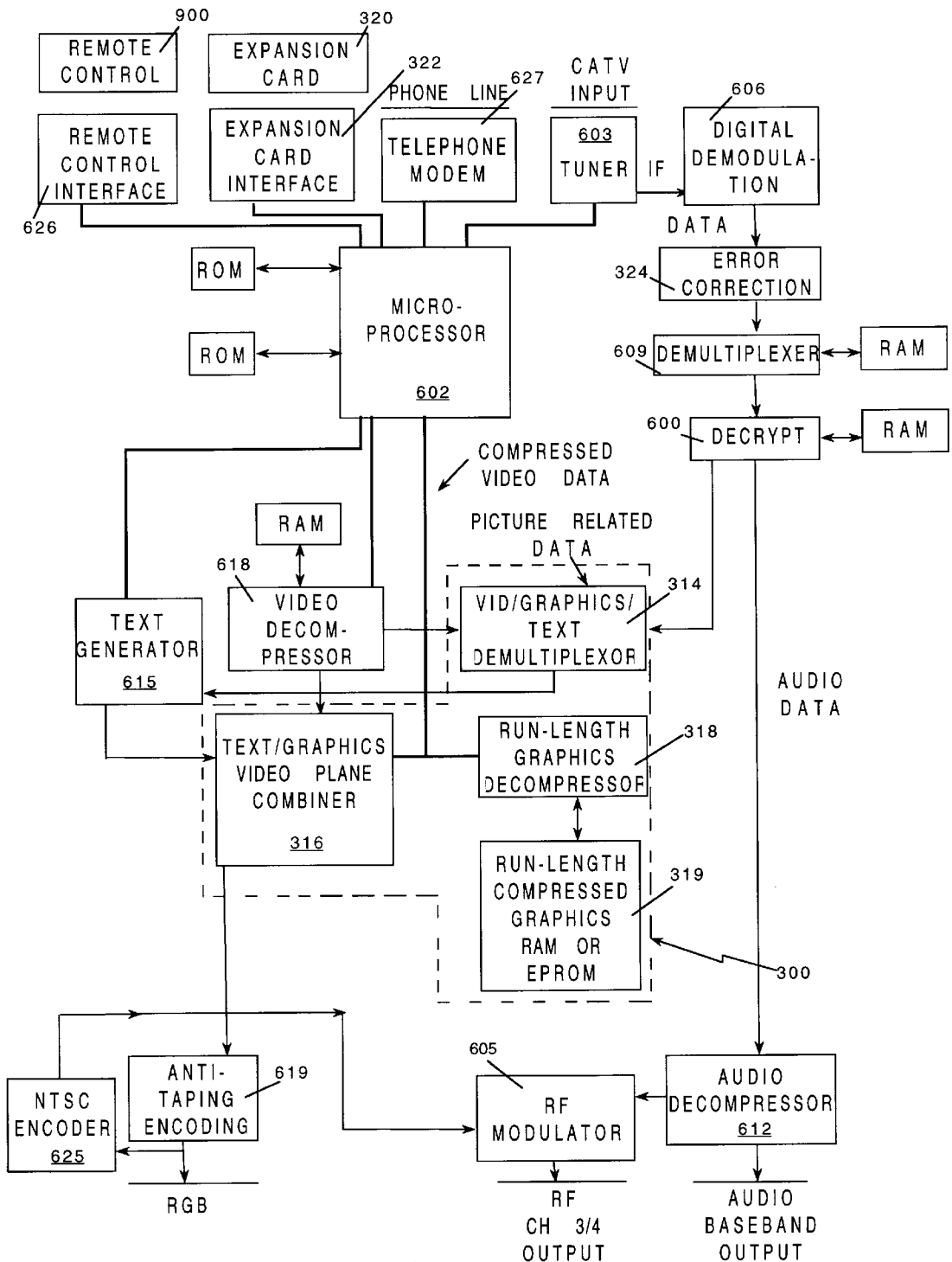
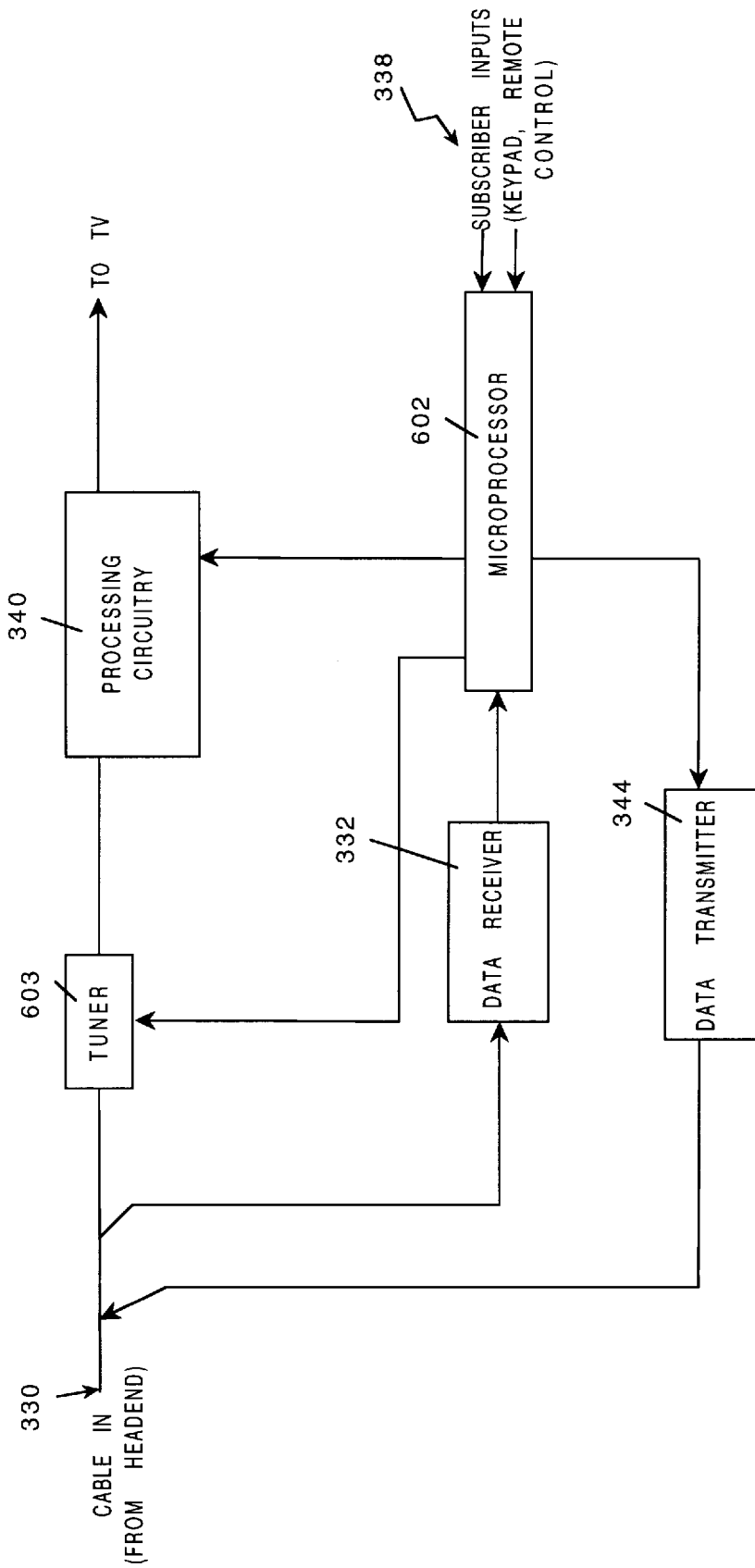

Fig. 10



SET TOP TERMINAL UPSTREAM DATA TRANSMISSION HARDWARE

Fig. 11

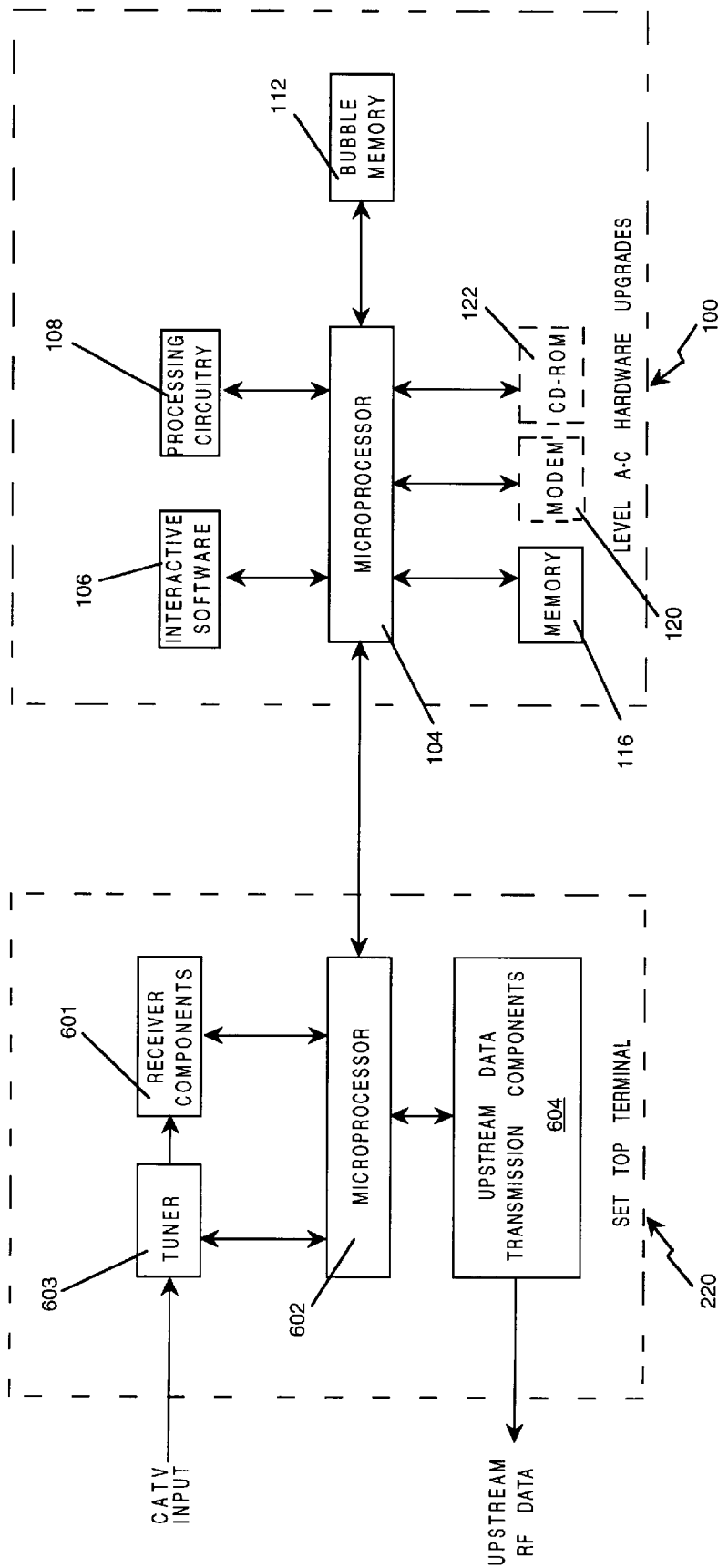

Fig. 12a

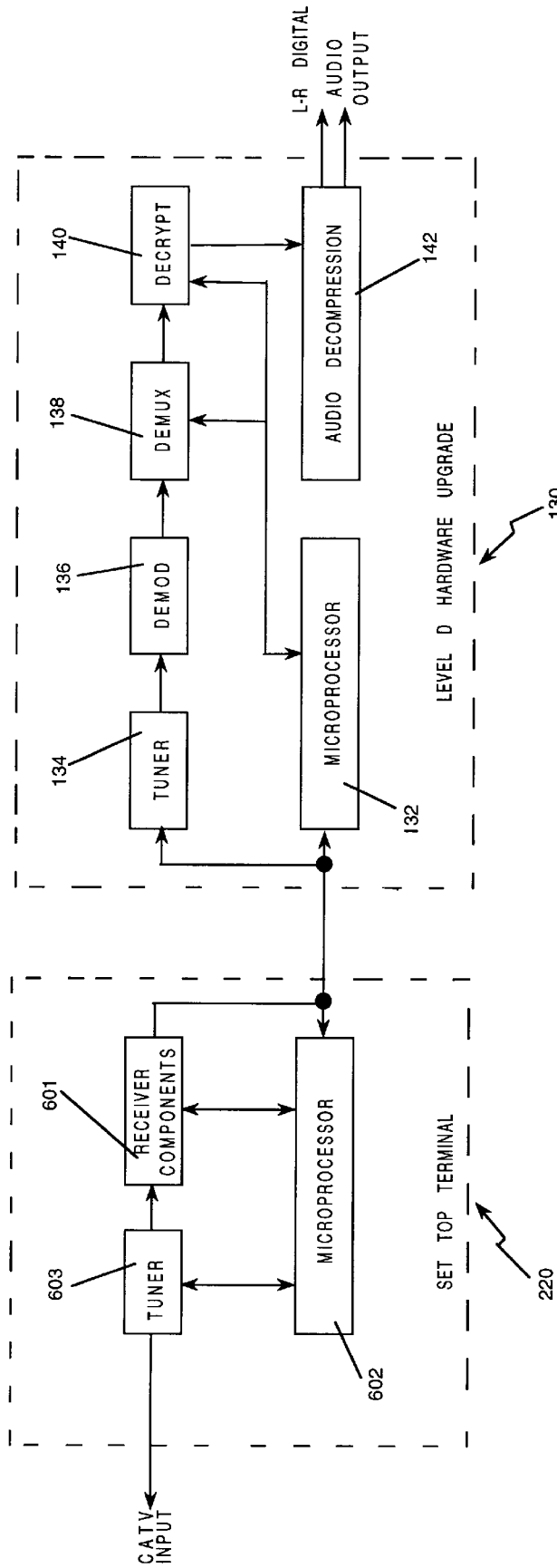

Fig. 12b

Fig. 13a

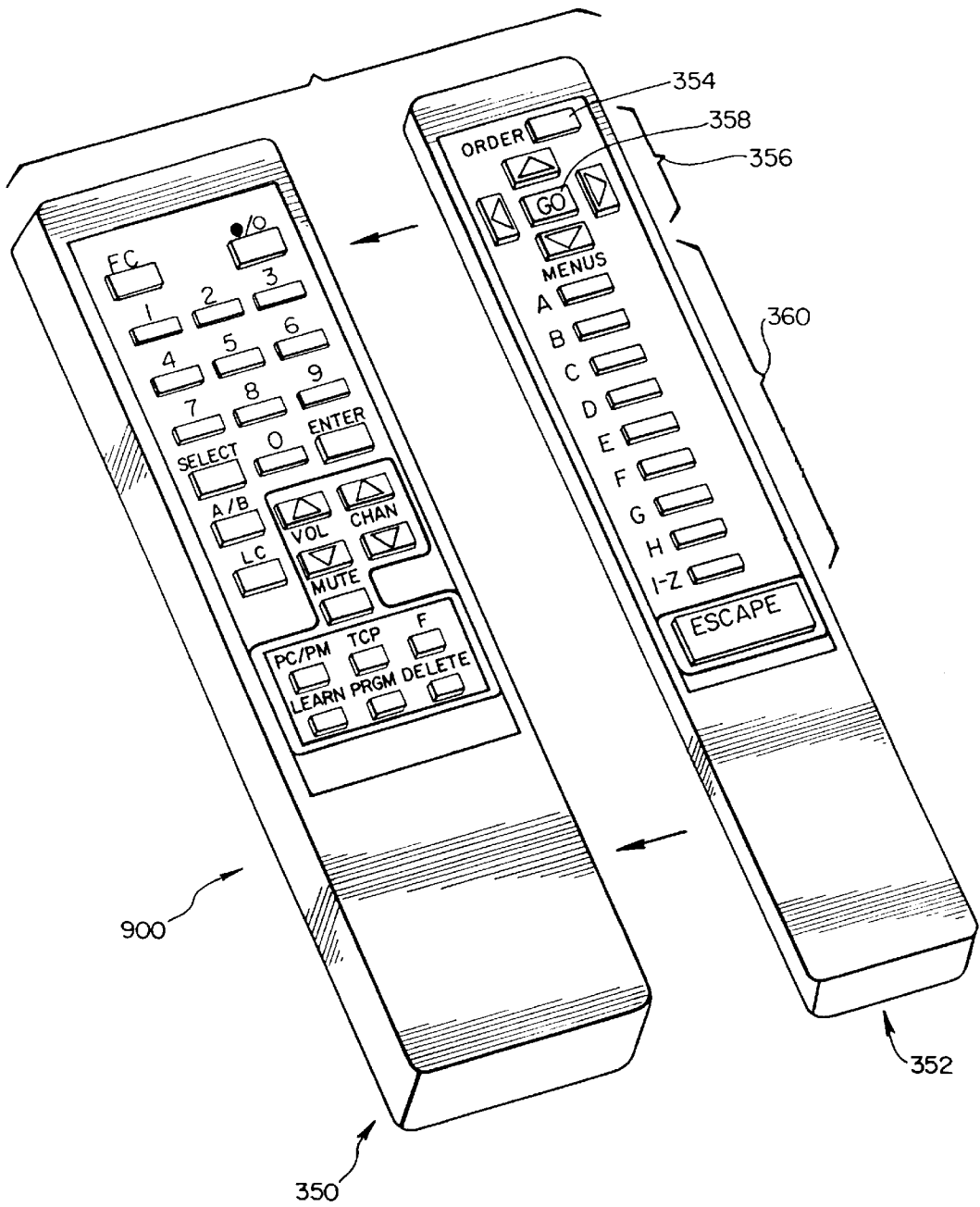
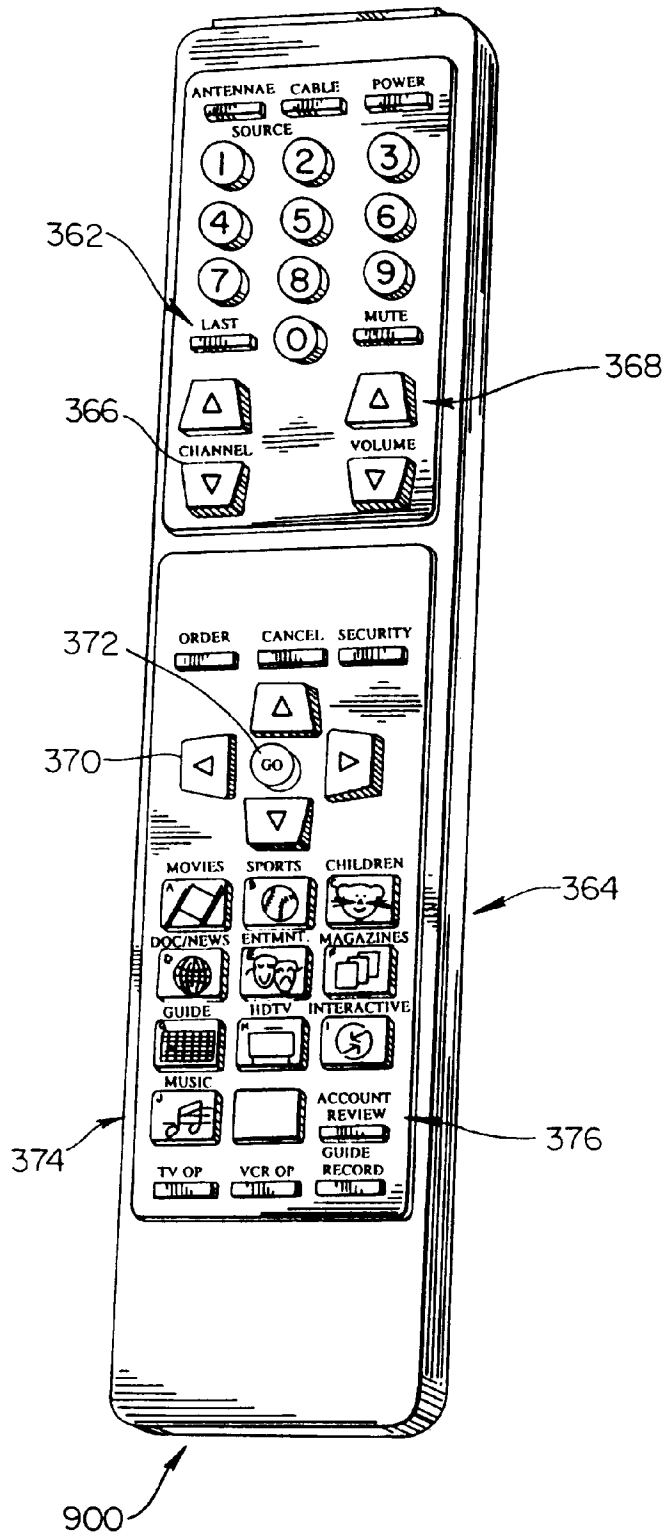

Fig. 13b



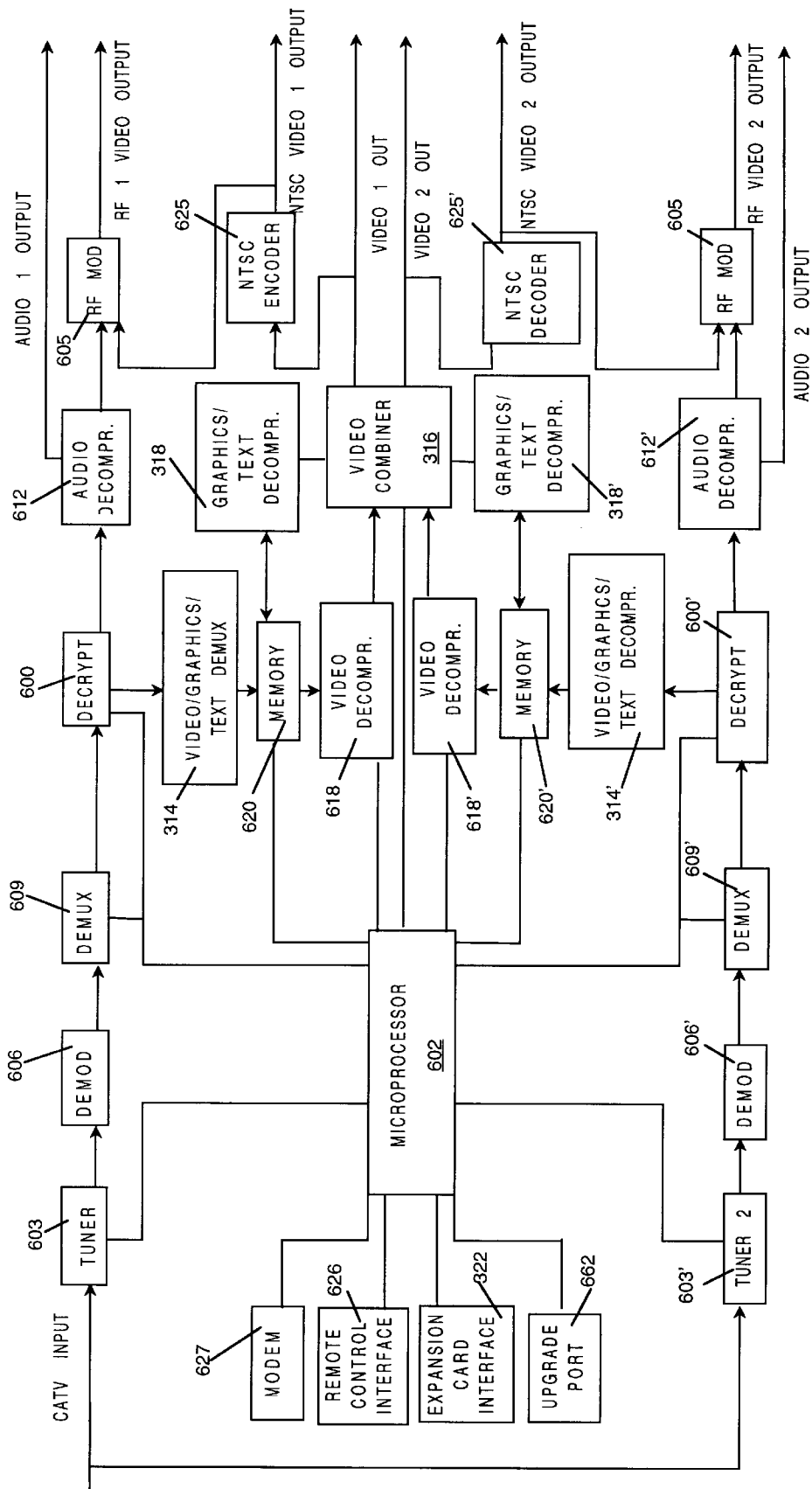

Fig. 14

Fig. 15

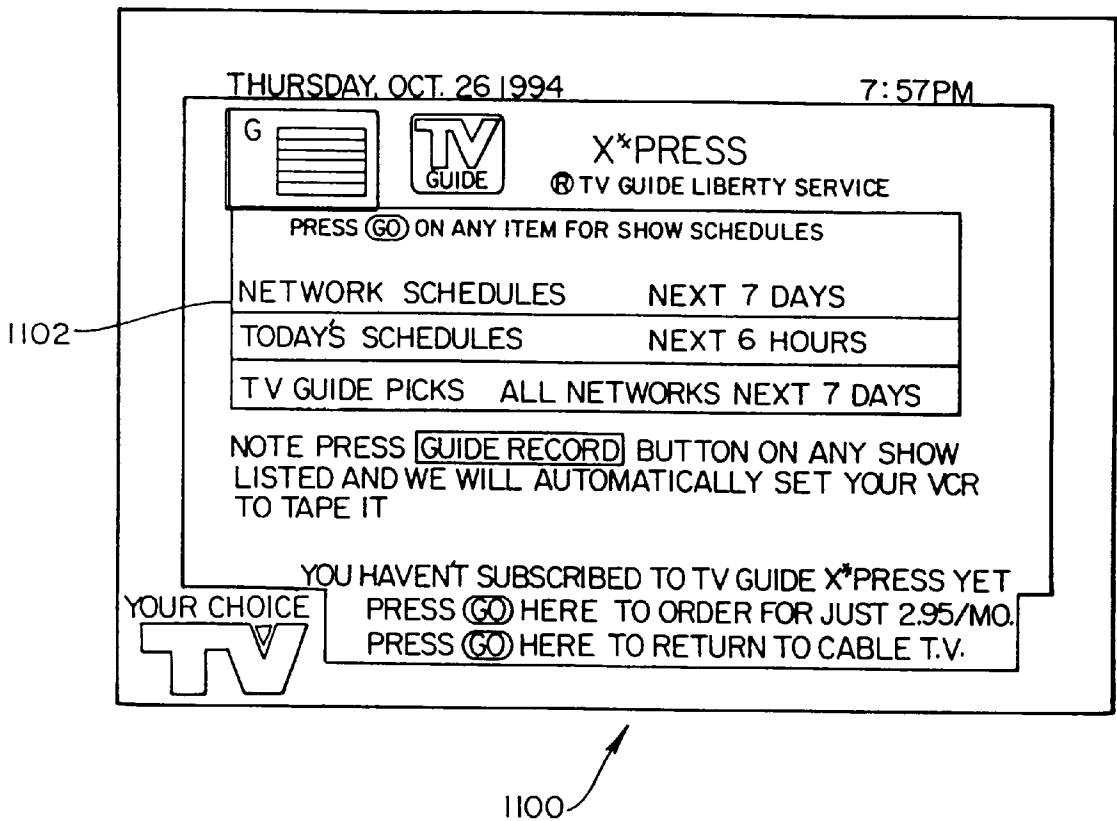
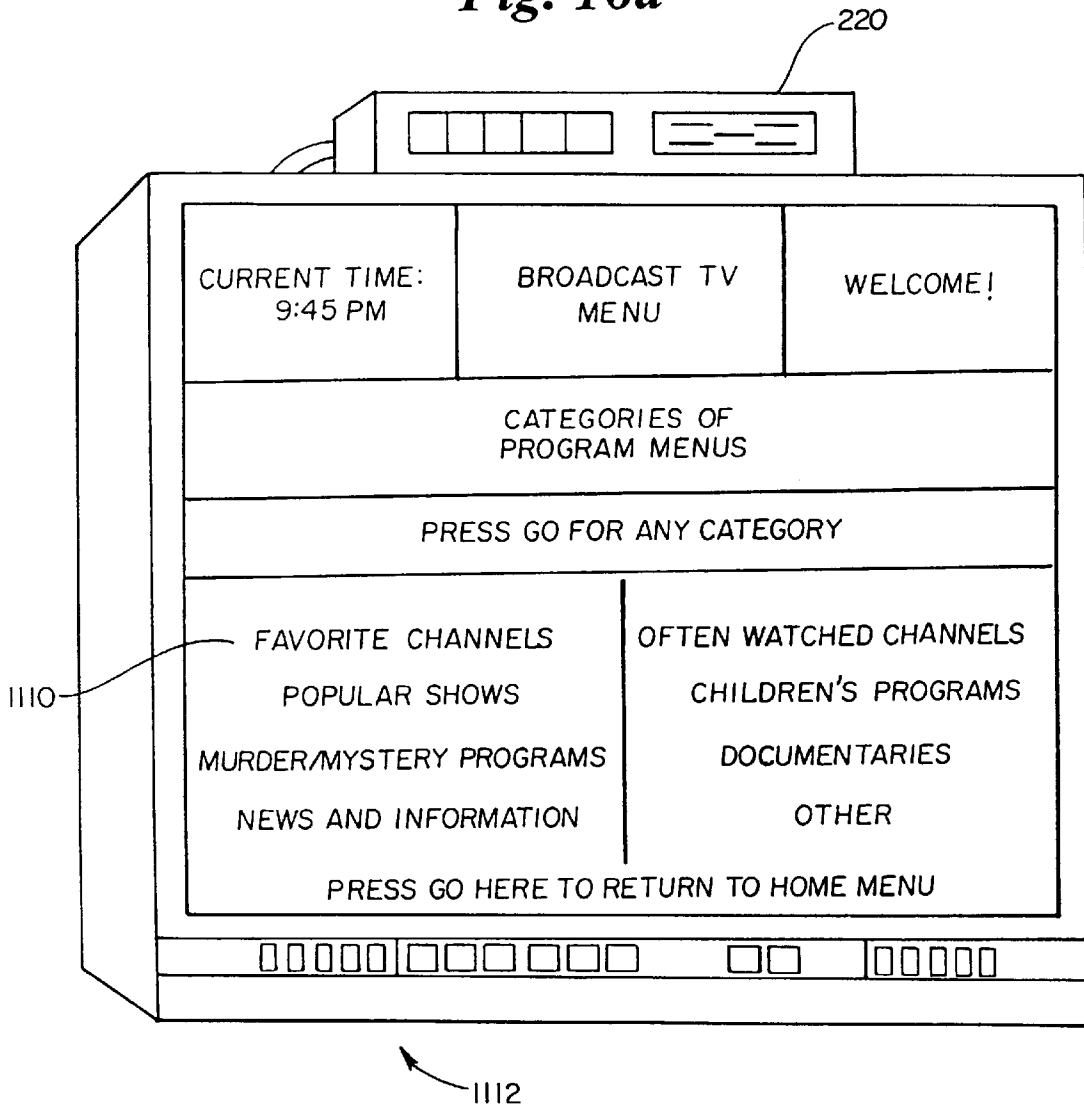

Fig. 16a



MOOD QUESTION MENUS

1114

LENGTH OF PROGRAM DESIRED

SHORT	30 minutes or less
MEDIUM	30 to 60 minutes
LONG	60 minutes or more

Fig. 16b

1116

TYPE OF PROGRAM DESIRED

SERIOUS
THOUGHTFUL
LIGHT

Fig. 16c

1118

DO YOU WISH AN ACTIVE OR PASSIVE PROGRAM?

ACTIVE
PASSIVE

Fig. 16d

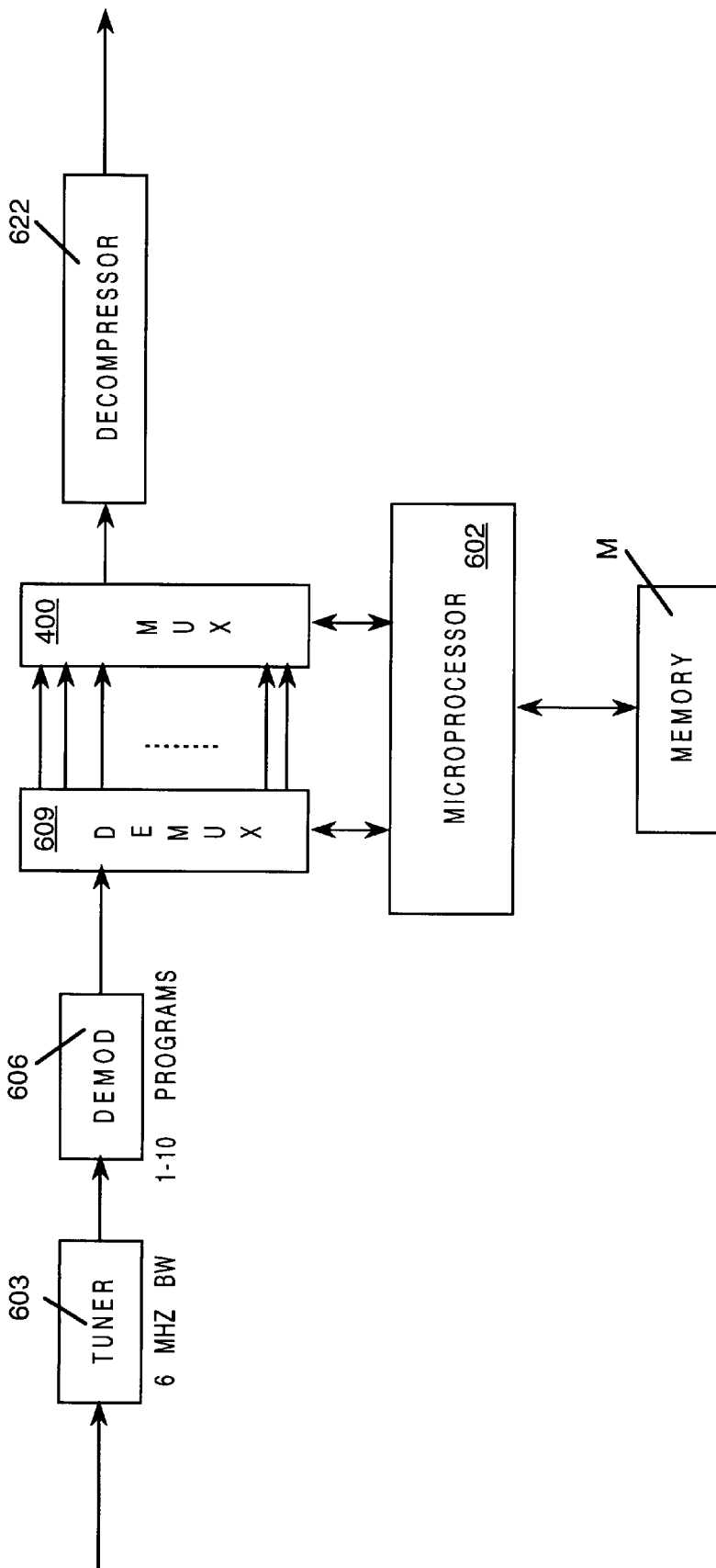

S TT CHANNEL SWITCHING HARDWARE: CHANNEL SWITCHING WITHIN 6MHZ BANDWIDTH

Fig. 17a

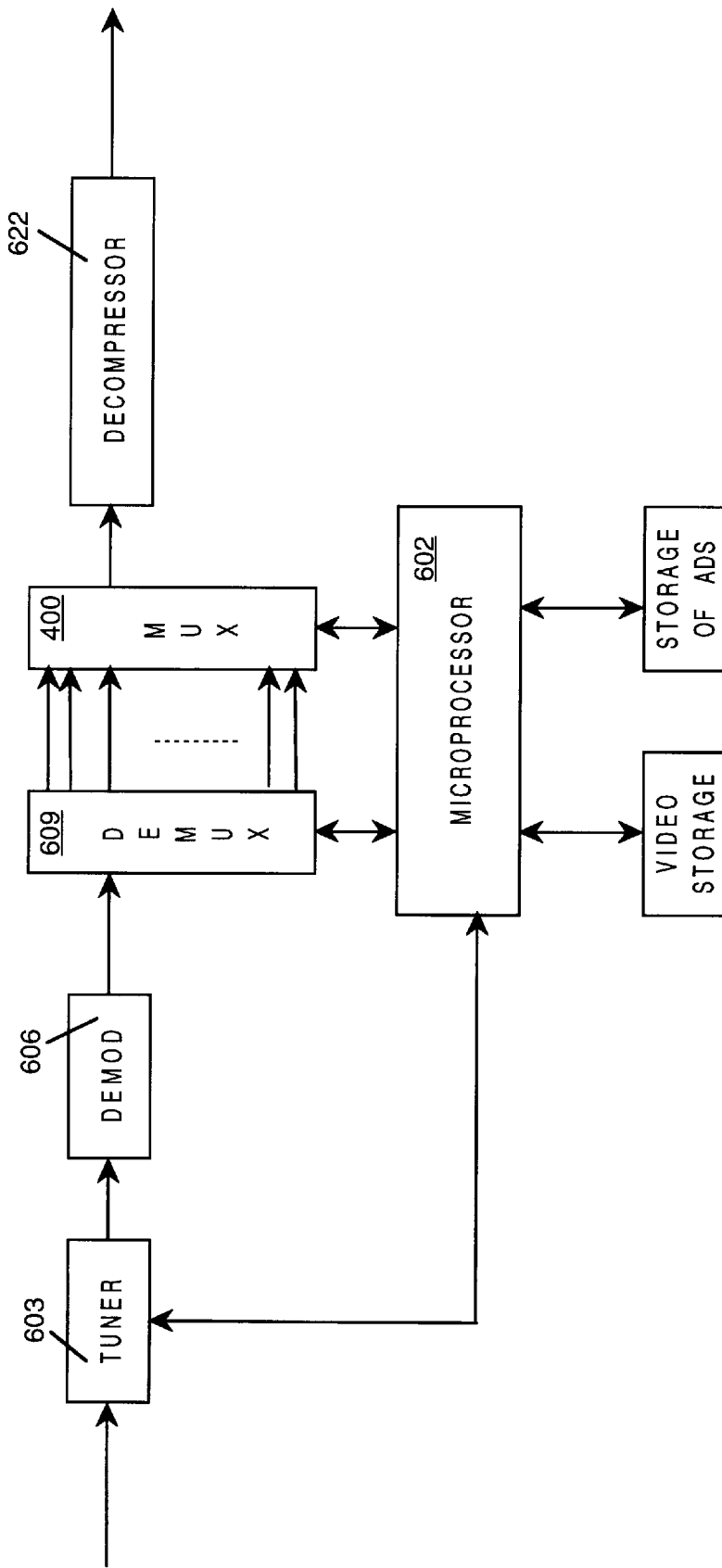

S TT CHANNEL SWITCHING HARDWARE: CHANNEL SWITCHING
OUTSIDE 6MHZ BANDWIDTH

Fig. 17b

Fig. 18

THURSDAY, OCTOBER 26, 1994 8:00 PM



INTERACTIVE SERVICES LEVEL B

THIS LEVEL OF INTERACTIVITY ALLOWS YOU TO ACCESS A WIDE RANGE OF SERVICES INCLUDING:

PRODIGY	ENCYCLOPEDIA
AMERICA ON LINE	ATLAS
X PRESS	SHOPPING CENTER
AIRLINE RESERVATIONS	ASSOCIATED PRESS
HOTEL RESERVATIONS	U.S. YELLOW PAGES

TO TAKE ADVANTAGE OF THESE SERVICES AN INTERACTIVE MODEM IS REQUIRED. THIS IS AVAILABLE FROM YOUR CABLE SYSTEM. FOR INSTALLATION AND PRICE INFORMATION, CONTACT YOUR CABLE SYSTEM TODAY.

YOUR CHOICE



PRESS  HERE FOR MORE INFORMATION

PRESS  HERE TO RETURN TO CABLE TV

↖ 1120

Fig. 19a

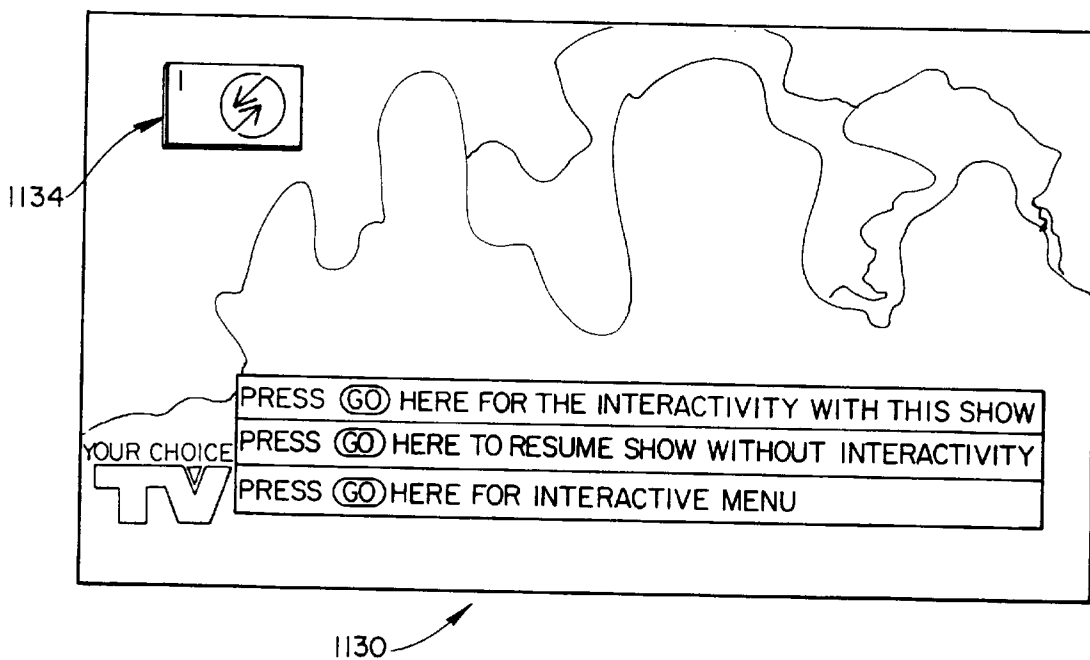

Fig. 19b

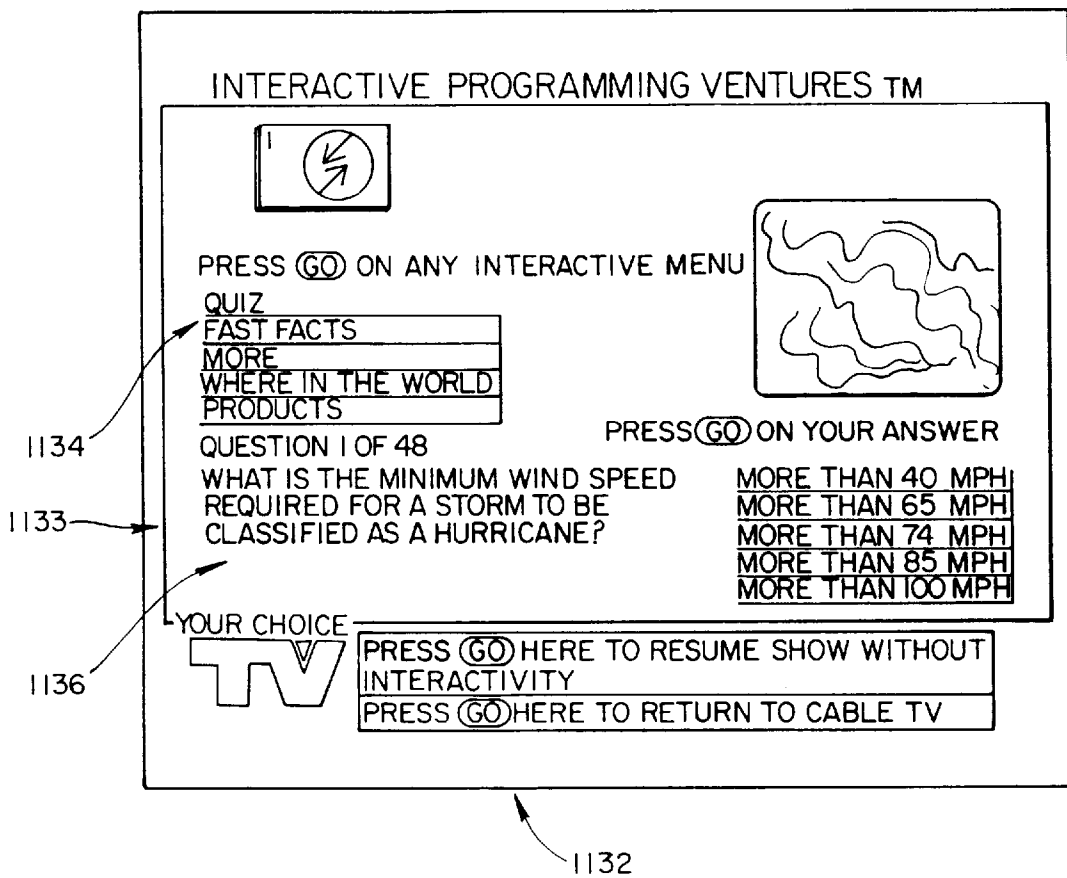
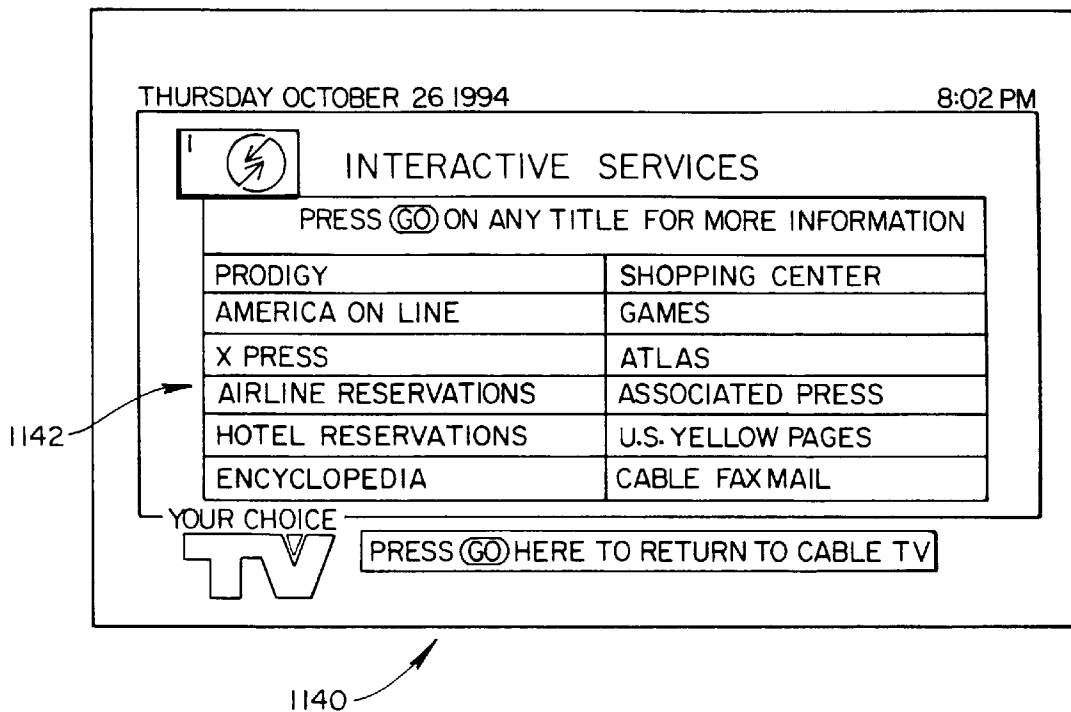
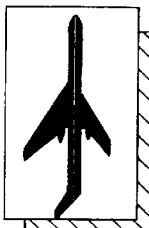

Fig. 20a



Thursday, October 26, 1994

8:04 PM



AIRLINE INFORMATION AND RESERVATIONS(continued)

Here are your airline flight options for a morning departure from Phoenix to Dulles.

Press on Any Flight to Check Availability and Fare

Depart Time	Arrive Time	Airline	Flight No.	Stops	Connecting Through
6:15 AM	1:30 PM	AMERICAN	32	0	
7:30 AM	2:45 PM	AMERICAN	212	0	
8:00 AM	3:07 PM	DELTA	49	0	
10:30 AM	7:15 PM	US AIR	285	1	Chicago
11:25 AM	6:10 PM	UNITED	10	0	
11:45 AM	8:40 PM	UNITED	77	1	Dallas

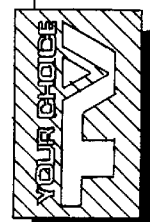

Press Here to Return to Airline Main Menu

Press Here to Return to Menu

Press Here to Return to Cable TV

1144

FIG. 20b

Thursday, October 26, 1994 8:05PM

AIRLINE INFORMATION AND RESERVATIONS (continued)

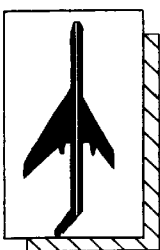

DELTA FLIGHT #49 from Phoenix to Dulles direct
departs 8:00 AM and arrives 3:07 PM

SEATS AVAILABLE ARE SHOWN IN BLUE

3 First Class Seats Remaining
15 Coach Class Seats Remaining

Press on Any Blue Seat(s) to Make Reservations

First Class	Coach Class	Aircraft Equipment 757

aisle

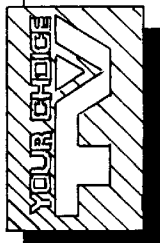

Press Here to Erase Above and Repeat

Press Here to Cancel Above and Exit

Press Here to Continue

1150

1152

FIG. 20c

Thursday, October 26, 1994

8:06 PM

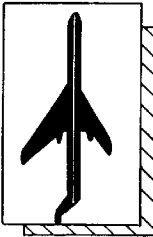

AIRLINE INFORMATION AND RESERVATIONS(continued)

CREDIT CARD CHARGE

Amount: \$ 590.00 Delta Flight # 49

One Way: Phoenix to Dulles Date: 11/25/94

Departs: 8:00AM Arrives: 3:07 PM Dinner

American
Express

Discover

Master
Charge

Enter Your Credit Card Number:

2

1

7

7

3

5

Enter Expiration Date (example 09/97):

Month:

Year:

Press  Here to Erase Above and Repeat

Press  Here to Cancel Above and Exit

Press  Here to Confirm Above Charge

YOUR CHOICE

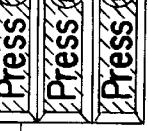

1156 

FIG. 20d

Thursday, October 26, 1994

8:08 PM

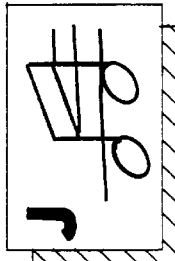

DMX Demonstration



Here are the menu options you'll enjoy:

Press On the station you want

Top 5	Hard Rock	Easy Listening	New Age	Country Top 40	Rhythm and Blues	Classical
Top 10	Heavy Metal	Instrumentals	Favorite Light Rock	New Country	Blues Legends	Classical Piano
Top 40	Rock Classics	Easy List. Favorites	Beatles Only	Country Classics	Soul	Classical Strings
Rock	Rap	Jazz	Rock Legends	Bluegrass	Soul Classics	Classical Guitar
'30s	'40s	'50s	'60s	'70s	'80s	'90s
Waltz	Latin	Disco	Polka	Reggae	Dance Fever	Teen Dance
You are Listening to: MAGGIE MAY by Rod Stewart 1972						
More Information on Current Artist/Song						
Screen ON/OFF						

1162

1164

All this for just \$ 4.95 per month. Less than 1/2 the cost of one CD! ORDER NOW.

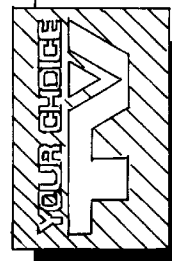

Press Here to Order DMX

Press Here to Return to Cable TV

1160

FIG. 21

Fig. 22

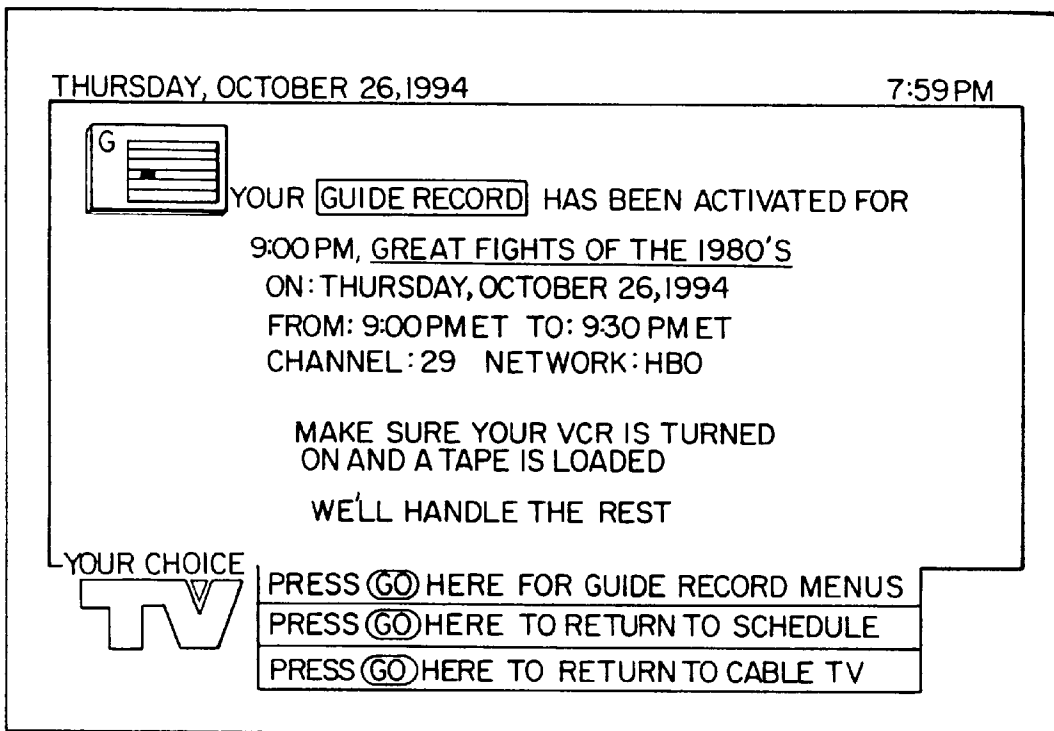
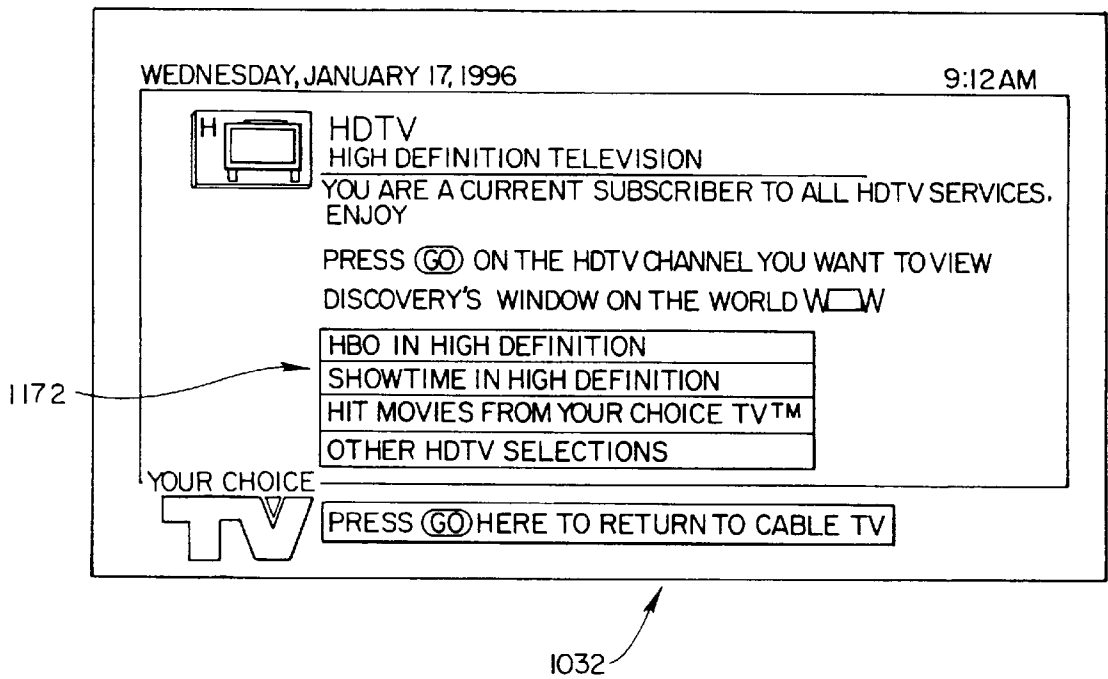

Fig. 23



ADVANCED SET TOP TERMINAL FOR CABLE TELEVISION DELIVERY SYSTEMS

RELATED APPLICATIONS

This application is a continuation-in-part of application Ser. No. 07/991,074 filed Dec. 9, 1992 entitled TELEVISION PROGRAM PACKAGING AND DELIVERY SYSTEM WITH MENU DRIVEN SUBSCRIBER ACCESS. The following other continuation-in-part applications, also based on the above-referenced patent application, are incorporated herein by reference:

Ser. No. 08/160,281, entitled REPROGRAMMABLE TERMINAL FOR SUGGESTING PROGRAMS OFFERED ON A TELEVISION PROGRAM DELIVERY SYSTEM, filed on Dec. 2, 1993;

Ser. No. 08/160,280, entitled NETWORK CONTROLLER FOR CABLE TELEVISION DELIVERY SYSTEMS, filed on Dec. 2, 1993;

Ser. No. 08/160,282, entitled AN OPERATIONS CENTER FOR A TELEVISION PROGRAM PACKAGING AND DELIVERY SYSTEM, filed on Dec. 2, 1993;

Ser. No. 08/160,193, entitled SET TOP TERMINAL FOR CABLE TELEVISION DELIVERY SYSTEMS, filed on Dec. 2, 1993;

Ser. No. 08/160,283, entitled DIGITAL CABLE HEAD-END FOR CABLE TELEVISION DELIVERY SYSTEM, filed on Dec. 2, 1993.

TECHNICAL FIELD

The invention relates to television entertainment systems for providing television programming to consumer homes. More particularly, the invention relates to a set top terminal for use with a program delivery system with menu selection of programs.

BACKGROUND OF THE INVENTION

Advances in television entertainment have been primarily driven by breakthroughs in technology. In 1939, advances on Vladimir Zworykin's picture tube provided the stimulus for NBC to begin its first regular broadcasts. In 1975, advances in satellite technology provided consumers with increased programming to homes.

Many of these technology breakthroughs have produced inconvenient systems for consumers. One example is the ubiquitous three remote control home, having a separate and unique remote control for the TV, cable box and VCR. More recently, technology has provided cable users in certain parts of the country with 100 channels of programming. This increased program capacity is beyond the ability of many consumers to use effectively. No method of managing the program choices has been provided to consumers.

Consumers are demanding that future advances in television entertainment, particularly programs and program choices, be presented to the consumer in a user friendly manner. Consumer preferences, instead of technological breakthroughs, will drive the television entertainment market for at least the next 20 years. As computer vendors have experienced a switch from marketing new technology in computer hardware to marketing better useability, interfaces and service, the television entertainment industry will also experience a switch from new technology driving the market to consumer useability driving the market.

Consumers want products incorporating new technology that are useful, and will no longer purchase new technology

for the sake of novelty or status. Technological advances in sophisticated hardware are beginning to surpass the capability of the average consumer to use the new technology. Careful engineering must be done to make entertainment products incorporating new technology useful and desired by consumers.

In order for new television entertainment products to be successful, the products must satisfy consumer demands. TV consumers wish to go from limited viewing choices to a variety of choices, from no control of programming to complete control. Consumers wish to advance from cumbersome and inconvenient television to easy and convenient television and keep costs down. Consumers do not wish to pay for one hundred channels when due to lack of programming information, they seldom, if ever, watch programming on many of these channels.

The concepts of interactive television, high definition television and 300 channel cable systems in consumer homes will not sell if they are not packaged, delivered and presented in a useable fashion to consumers. The problem is that TV programming is not being delivered and presented to consumers in a user friendly manner.

Consumers are already being bombarded with programming options, numerous "free" cable channels, subscription cable channels and pay-per-view choices. Any further increase in TV entertainment choices, without a user friendly presentation and approach, will likely bewilder viewers with a mind-numbing array of choices.

The TV industry has traditionally marketed and sold its programs to consumers in bulk, such as continuous feed broadcast and long-term subscriptions to movie channels. The TV industry is unable to sell its programming in large quantities on a unit per unit basis, such as the ordering of one program. Consumers prefer a unit sales approach because it keeps costs down and allows the consumer to be more selective in their viewing.

In addition, viewership fragmentation, which has already begun, will increase. Programming not presented in a user friendly manner will suffer with a decrease in viewership and revenue. As programming presentation becomes more user friendly, users seek additional features and functional capabilities.

What is needed is a system which can deliver and present television programming through a user friendly interface which allows the consumer to easily select from among the many program choices.

What is needed is a set top converter that provides a user friendly interface for subscribers to access television programs.

What is needed is a set top converter with enhanced functionality.

What is needed is a set top converter that provides users with advanced features and capabilities.

What is needed is a method that allows efficient access to hundreds of television programming options.

What is needed is technology that upgrades the functionality of existing set top converters.

What is needed is hardware that provides an upgrade capability allowing the use of existing set top converter technology in advanced program delivery systems.

What is needed is a set top converter that provides an upstream communications capability between the set top converter and cable headend.

What is needed is a set top converter that provides a capability of generating menus for display.

What is needed is a set top converter that provides a simple way to select a program from a menu.

What is needed is a set top converter that allows users to subscribe on-screen to specialty channels.

What is needed is a set top converter that monitors subscriber viewing choices for statistical purposes.

What is needed is a set top converter that provides sophisticated on-screen television menus which can incorporate still video and moving video.

What is needed is a set top converter that provides a capability of scaling and redirecting video for menus. The present invention is addressed to fulfill these needs.

SUMMARY OF INVENTION

The present invention is a set top converter box or terminal for a television program delivery system. More specifically, the present invention is an advanced set top converter box that acts as a terminal in the viewer home. The set top terminal is a key component of a digital cable television delivery system. The set top terminal is an upgradeable system that provides for the decompression of digital program signals. The preferred set top terminal provides both a menu generation capability as well as a number of advanced features and functional capabilities.

The set top terminal of the present invention may be achieved through a set of hardware upgrades to any of the following embodiments: (1) an existing set top converter upgraded with a circuit card (which has a microprocessor electronically connected to the set top converter); (2) an industry standard decompression converter upgradeable by either an upgrade module or a menu generation card, and (3) a set top converter box capable of both decompression and menu generation. The hardware upgrades provide additional advanced features and functional capabilities to any of these embodiments.

A number of advanced features and functional capabilities are supported by the preferred set top terminal. This set top terminal provides subscribers with a picture-on-picture capability without requiring a special television to support the capability. The set top terminal also supports a TV guide service, which provides subscribers with information on all programming available at its particular subscriber location. The set top terminal further includes the capability of querying viewers to establish, among other things, favorite channel lists, personal profile data and mood information. The set top terminal allows the subscriber to view promotional menus on future programming events.

The set top terminal supports additional capabilities using its hardware upgrades that allow subscribers to use other interactive services, for example, to engage in on-line question and answer sessions, to order and confirm airline tickets, and to access a variety of other data services. The set top terminal makes use of a digital tuner as a hardware upgrade to provide subscribers with a digital audio capability.

The preferred set top terminal may be used to control video tape machines, thereby simplifying the recording of programs. The set top terminal can, in conjunction with the program delivery system, easily support high definition television (HDTV). For subscribers living in remote locations, the set top terminal accommodates backyard satellite systems. In addition to all the features that the set top terminal supports with its current internal programming and upgradeability, additional features may be added or existing features increased through remote reprogramming of the set top terminal **220**.

It is an object of the invention to provide a user friendly interface for subscribers to access television programs.

It is an object of the invention to allow users to easily navigate through hundreds of programming choices using on-screen menus.

It is an object of this invention to efficiently access hundreds of television programming options.

It is an object of this invention to upgrade the functionality of existing set top converters.

It is an object of this invention to provide an upgrade capability allowing the use of existing set top converter technology in an advanced program delivery system.

It is an object of is invention to provide an upstream communications capability between the set top converter and cable headend.

It is an object of this invention to provide a set top terminal capable of generating menus for display.

It is an object of this invention to allow users to subscribe on-screen to specialty channels.

It is an object of this invention to monitor subscriber viewing choices for statistical purposes.

It is an object of this invention to provide sophisticated on-screen television menus which can incorporate still video and moving video.

These and other objects and advantages of the invention will become obvious to those skilled in the art upon review of the following description, the attached drawings and appended claims.

DESCRIPTION OF THE DRAWINGS

FIG. 1 is a diagram of the primary components of the television delivery system.

FIG. 2 is an overview of the television delivery system operations.

FIG. 3 is a schematic of the operation of the primary components of the system.

FIG. 4 is a block diagram of the hardware components of the set top terminal.

FIG. 5a is a perspective front view of a set top terminal.

FIG. 5b is a perspective rear view of a set top terminal.

FIG. 6 is a schematic of a Turbo card upgrade for a set top terminal.

FIG. 7a is a drawing of a frame format for program control information signal.

FIG. 7b is a drawing of a frame format for a polling response from the set top terminal.

FIG. 8 is a drawing of the basic menus used in the present invention, including the ten major menus represented by icons.

FIG. 9a is a schematic of a basic decompression box with upgrade module and associated connections.

FIG. 9b is a schematic of an alternative embodiment of a simple decompression box with upgrade module and associated connections.

FIG. 10 is a more detailed block diagram of the components of a simple decompression box with upgrade module.

FIG. 11 is a schematic of the set top terminal's upstream data transmission hardware.

FIG. 12a is a schematic showing the components of the Level A, B, and C hardware upgrades.

FIG. 12b is a schematic showing the components of the Level D hardware upgrade.

FIG. 13a is a schematic showing the two parts of a remote control unit.

FIG. 13b is a drawing of the preferred remote control unit.

FIG. 14 is a diagram of the components of a set top terminal having a picture-on-picture capability.

FIG. 15 is a drawing of a menu related to program catalogue services.

FIGS. 16a through 16d are drawings of viewer querying and mood question menus.

FIGS. 17a and 17b are drawings of the set top terminal hardware components that accommodate transparent channel switching.

FIG. 18 is a drawing of an interactive television promotional menu for a set top terminal hardware upgrade.

FIGS. 19a and 19b are drawings of submenus for interactive television services using hardware upgrade Level A.

FIGS. 20a through 20d are drawings of interactive services using hardware upgrade Level B which are related to on-screen airline reservations.

FIG. 21 is a drawing of a menu for digital audio services.

FIG. 22 is a drawing of a menu related to program guide services.

FIG. 23 is a drawing of a menu related to high definition television (HDTV) programming.

DETAILED DESCRIPTION OF THE PREFERRED EMBODIMENT

A. Television Program Delivery System Description

1. Introduction

FIG. 1 shows the present invention as part of an expanded cable television program delivery system 200 that dramatically increases programming capacity using compressed transmission of television program signals. Developments in digital bandwidth compression technology now allow much greater throughput of television program signals over existing or slightly modified transmission media. The program delivery system 200 shown provides subscribers with a user friendly interface to operate and exploit a six-fold or more increase in current program delivery capability.

Subscribers are able to access an expanded television program package and view selected programs through a menu-driven access scheme that allows each subscriber to select individual programs by sequencing a series of menus. The menus are sequenced by the subscriber using simple alpha-numeric and iconic character access or moving a cursor or highlight bar on the TV screen to access desired programs by simply pressing a single button, rather than recalling from memory and pressing the actual two or more digit numeric number assigned to a selection. Thus, with the press of a single button, the subscriber can advance from one menu to the next. In this fashion, the subscriber can sequence the menus and select a program from any given menu. The programs are grouped by category so that similar program offerings are found on the same menu.

2. Major System Components

In its most basic form, the system uses a program delivery system 200 in conjunction with a conventional concatenated cable television system 210. The program delivery system 200 generally includes (i) at least one operations center 202, where program packaging and control information are created and then assembled in the form of digital data, (ii) a digital compression system, where the digital data is compressed, combined/multiplexed, encoded, and mapped

into digital signals for satellite transmission to the cable headend 208, and (iii) a set of in-home decompressors. The program delivery system 200 transports the digital signals to the cable headend 208 where the signals are transmitted through a concatenated cable television system 220. Within the cable headend 208, the received signals may be decoded, demultiplexed, managed by a local central distribution and switching mechanism, combined and then transmitted to the set top terminal 220 located in each subscriber's home over the cable system 210. Although concatenated cable systems 210 are the most prevalent transmission media to the home, telephone lines, cellular networks, fiberoptics, Personal Communication Networks and similar technology for transmitting to the home can be used interchangeably with this program delivery system 200.

The delivery system 200 has a reception region 207 with an in-home decompression capability. This capability is performed by a decompressor housed within a set top terminal 220 in each subscriber's home. The decompressor remains transparent from the subscriber's point of view and allows any of the compressed signals to be demultiplexed and individually extracted from the composite data stream and then individually decompressed upon selection by the subscriber. The decompressed video signals are converted into analog signals for television display. Such analog signals include NTSC formatted signals for use by a standard television. Control signals are likewise extracted and decompressed and then either executed immediately or placed in local storage such as a RAM. Multiple sets of decompression hardware may be used to decompress video and control signals. The set top terminal 220 may then overlay or combine different signals to form the desired display on the subscriber's television. Graphics on video or picture-on-picture are examples of such a display.

Although a single digital compression standard (e.g., MPEG) may be used for both the program delivery system 200 and the concatenated cable system 210, the compression technique used may differ between the two systems. When the compression standards differ between the two media, the signals received by the cable headend 208 must be decompressed before transmission from the headend 208 to the set top terminals 220. Subsequently, the cable headend 208 must recompress and transmit the signals to the set top terminal 220, which would then decompress the signals using a specific decompression algorithm.

The video signals and program control signals received by the set top terminal 220 correspond to specific television programs and menu selections that each subscriber may access through a subscriber interface. The subscriber interface is a device with buttons located on the set top terminal 220 or on a portable remote control 900. In the preferred system embodiment, the subscriber interface is a combined alpha-character, numeric and iconic remote control device 900, which provides direct or menu-driven program access. The preferred subscriber interface also contains cursor movement and go buttons as well as alpha, numeric and iconic buttons. This subscriber interface and menu arrangement enables the subscriber to sequence through menus by choosing from among several menu options that are displayed on the television screen. In addition, a user may bypass several menu screens and immediately choose a program by selecting the appropriate alpha-character, numeric or iconic combinations on the subscriber interface. In the preferred embodiment, the set top terminal 220 generates the menus that are displayed on the television by creating arrays of particular menu templates, and the set top terminal 220 displays a specific menu or submenu option for each available video signal.

3. Operations Center and Digital Compression System

The operations center **202** performs two primary services, packaging television programs and generating the program control information signal. At the operations center **202**, television programs are received from external program sources in both analog and digital form. FIG. 2 shows an embodiment of the operations center receiving signals from various external sources **222**. Examples of the external program sources are sporting events, children's programs, specialty channels, news or any other program source that can provide audio or visual signals. Once the programs are received from the external program sources, the operations center **202** digitizes (and preferably compresses) any program signals received in analog form. The operations center **202** may also maintain an internal storage of programs. The internally stored programs may be in analog or digital form and stored on permanent or volatile memory sources, including magnetic tape or RAM. Subsequent to receiving programming, the operations center **202** packages the programs into the groups and categories which provide the optimal marketing of the programs to subscribers. For example, the operations center **202** may package the same programs into different categories and menus for weekday, prime-time viewing and Saturday afternoon viewing. Also, the operations center **202** packages the television programs in a manner that enables both the various menus to easily represent the programs and the subscribers to easily access the programs through the menus.

The packaging of the digital signals is typically performed at the operations center **202** by computer assisted packaging equipment (CAP). The CAP system normally includes at least one computer monitor, keyboard, mouse, and standard video editing equipment. A programmer packages the signals by entering certain information into the CAP. This information includes the date, time slot, and program category of the various programs. The programmer and the CAP utilize demographic data and ratings in performing the packaging tasks. After the programmer selects the various programs from a pool of available programs and inputs the requisite information, the programmer, with assistance from the CAP, can select the price and allocate transponder space for the various programs. After the process is complete, the CAP displays draft menus or program schedules that correspond to the entries of the programmer. The CAP may also graphically display allocation of transponder space. The programmer may edit the menus and transponder allocation several times until satisfied with the programming schedule. During the editing, the programmer may direct the exact location of any program name on a menu with simple commands to the CAP.

The packaging process also accounts for any groupings by satellite transponder which are necessary. The operations center **202** may send different groups of programs to different cable headends **208** and/or set top terminals **220**. One way the operations center **202** may accomplish this task is to send different program packages to each transponder. Each transponder, or set of transponders, then relays a specific program package to specific cable headends **208** and/or set top terminals **220**. The allocation of transponder space is an important task performed by the operations center **202**.

The operations center **202** may also "insert" directions for filling local available program time in the packaged signal to enable local cable and television companies to fill the program time with local advertising and/or local programming. Consequently, the local cable headends **208** are not constrained to show only programs transmitted from the operations center **202**. New set top converters will incorpo-

rate both digital and analog channels. Therefore, the cable headend **208** may combine analog signals with the digital signals prior to transmitting the program signals to the set top terminals **220**.

After the CAP packages the programs, it creates a program control information signal to be delivered with the program package to the cable headend **208** and/or set top terminal **220**. The program control information signal contains a description of the contents of the program package, commands to be sent to the cable headend **208** and/or set top terminal **220**, and other information relevant to the signal transmission.

In addition to packaging the signal, the operations center **202** employs digital compression techniques to increase existing satellite transponder capacity by at least a 4:1 ratio, resulting in a four-fold increase in program delivery capability. A number of digital compression algorithms currently exist which can achieve the resultant increase in capacity and improved signal quality desired for the system. The algorithms generally use one or more of three basic digital compression techniques: (1) within-frame (intraframe) compression, (2) frame-to-frame (interframe) compression, and (3) within carrier compression. Specifically, in the preferred embodiment, the MPEG 2 compression method is used. After digital compression, the signals are combined (multiplexed) and encoded. The combined signal is subsequently transmitted to various uplink sites **204**.

There may be a single uplink site **204** or multiple uplink sites (represented by **204'**, shown in phantom in FIG. 1) for each operation center **202**. The uplink sites **204** may either be located in the same geographical place or may be located remotely from the operations center **202**. Once the composite signal is transmitted to the uplink sites **204**, the signal may be multiplexed with other signals, modulated, upconverted and amplified for transmission over satellite. Multiple cable headends **208** may receive such transmissions.

In addition to multiple uplinks, the delivery system **200** may also contain multiple operations centers. The preferred method for using multiple operations centers is to designate one of the operations centers as a master operations center and to designate the remaining operations centers as slave operations centers. In this configuration, the master operations center coordinates various functions among the slave operations centers such as synchronization of simultaneous transmissions and distributes the operations workload efficiently.

4. Cable Headend

After the operations center **202** has compressed and encoded the program signals and transmitted the signals to the satellite, the cable headend **208** receives and further processes the signals before they are relayed to each set top terminal **220**. Each cable headend site is generally equipped with multiple satellite receiver dishes. Each dish is capable of handling multiple transponder signals from a single satellite and sometimes from multiple satellites.

As an intermediary between the set top terminals **220** and the operations center **202** (or other remote site), the cable headend **208** performs two primary functions. First, the cable headend **208** acts as a distribution center, or signal processor, by relaying the program signal to the set top terminal **220** in each subscriber's home. In addition, the cable headend **208** acts as a network controller **214** by receiving information from each set top terminal **220** and passing such information on to an information gathering site such as the operations center **202**.

FIG. 3 shows an embodiment where the cable headend **208** and the subscriber's home are linked by certain com-

munications media **216**. In this particular embodiment, analog signals, digitally compressed signals, other digital signals and up-stream/interactivity signals are sent and received over the media **216**. The cable headend **208** provides such signaling capabilities in its dual roles as a signal processor **209** and network controller **214**.

As a signal processor **209**, the cable headend **208** prepares the program signals that are received by the cable headend **208** for transmission to each set top terminal **220**. In the preferred system, the signal processor **209** re-routes or demultiplexes and recombines the signals and digital information received from the operations center **202** and allocates different portions of the signal to different frequency ranges. Cable headends **208** which offer different subscribers different program offerings may allocate the program signals from the operations center **202** in various manners to accommodate different viewers. The signal processor **209** may also incorporate local programming and/or local advertisements into the program signal and forward the revised signal to the set top terminals **220**. To accommodate this local programming availability, the signal processor **209** must combine the local signal in digital or analog form with the operations center program signals. If the local cable system uses a compression standard that is different than the one used by the operations center **202**, the signal processor **209** must also decompress and recompress incoming signals so they may be properly formatted for transmission to the set top terminals **220**. This process becomes less important as standards develop (i.e., MPEG 2). In addition, the signal processor **209** performs any necessary signal decryption and/or encryption.

As a network controller **214**, the cable headend **208** performs the system control functions for the system. The primary function of the network controller **214** is to manage the configuration of the set top terminals **220** and process signals received from the set top terminals **220**. In the preferred embodiment, the network controller **214** monitors, among other things, automatic poll-back responses from the set top terminals **220** remotely located at each subscribers' home. The polling and automatic report-back cycle occurs frequently enough to allow the network controller **224** to maintain accurate account and billing information as well as monitor authorized channel access. In the simplest embodiment, information to be sent to the network controller **224** will be stored in RAM within each subscriber's set top terminal **220** and will be retrieved only upon polling by the network controller **214**. Retrieval may, for example, occur on a daily, weekly or monthly basis. The network controller **214** allows the system to maintain complete information on all programs watched using a particular set top terminal **220**.

The network controller **214** is also able to respond to the immediate needs of a set top terminal **220** by modifying a program control information signal received from the operations center **202**. Therefore, the network controller **214** enables the delivery system to adapt to the specific requirements of individual set top terminals **220** when the requirements cannot be provided to the operations center **202** in advance. In other words, the network controller **224** is able to perform "on the fly programing" changes. With this capability, the network controller **214** can handle sophisticated local programming needs such as, for example, interactive television services, split screen video, and selection of different foreign languages for the same video. In addition, the network controller **214** controls and monitors all compressors and decompressors in the system.

The delivery system **200** and digital compression of the preferred embodiment provides a one-way path from the

operations center **202** to the cable headend **208**. Status and billing information is sent from the set top terminal **220** to the network controller **214** at the cable headend **208** and not directly to the operations center **202**. Thus, program monitoring and selection control will take place only at the cable headend **208** by the local cable company and its decentralized network controllers **214** (i.e., decentralized relative to the operations center **202**, which is central to the program delivery system **200**). The local cable company will in turn be in communication with the operations center **202** or a regional control center (not shown) which accumulates return data from the set top terminal **220** for statistics or billing purposes. In alternative system embodiments, the operations center **202** and the statistical and billing sites are collocated. Further, telephone lines with modems are used to transfer information from the set top terminal **220** to the statistical and billing sites.

5. Set Top Terminal

The set top terminal **220** is the portion of the delivery system **200** that resides in the home of a subscriber. The set top terminal **220** is usually located above or below the subscriber's television, but it may be placed anywhere in or near the subscriber's home as long as it is within the range of the subscriber's remote control device **900**. In some aspects, the set top terminal **220** may resemble converter boxes already used by many cable systems. For instance, each set top terminal **220** may include a variety of error detection, decryption, and coding techniques such as anti-taping encoding. However, it will become apparent from the discussion below that the set top terminal **220** is able to perform many functions that an ordinary converter box cannot perform.

The set top terminal **220** has a plurality of input and output ports to enable it to communicate with other local and remote devices. The set top terminal **220** has an input port that receives information from the cable headend **208**. In addition, the unit has at least two output ports which provide communications from the set top terminal **220** to a television and a VCR. Certain menu selections may cause the set top terminal **220** to send control signals directly to the VCR to automatically program or operate the VCR. Also, the set top terminal **220** contains a phone jack which can be used for maintenance, trouble shooting, reprogramming and additional customer features. The set top terminal **220** may also contain stereo/audio output terminals and a satellite dish input port.

Functionally, the set top terminal **220** is the last component in the delivery system chain. The set top terminal **220** receives compressed program and control signals from the cable headend **208** (or, in some cases, directly from the operations center **202**). After the set top terminal **220** receives the individually compressed program and control signals, the signals are demultiplexed, decompressed, converted to analog signals (if necessary) and either placed in local storage (from which the menu template may be created), executed immediately, or sent directly to the television screen.

After processing certain signals received from the cable headend **208**, the set top terminal **220** is able to store menu templates for creating menus that are displayed on a subscriber's television by using an array of menu templates. Before a menu can be constructed, menu templates must be created and sent to the set top terminal **220** for storage. A microprocessor uses the control signals received from the operations center **202** or cable headend **208** to generate the menu templates for storage. Each menu template may be

stored in volatile memory in the set top terminal **220**. When the set top terminal receives template information it demultiplexes the program control signals received from the cable headend **208** into four primary parts: video, graphics, program logic and text. Each menu template represents a different portion of a whole menu, such as a menu background, television logo, cursor highlight overlay, or other miscellaneous components needed to build a menu. The menu templates may be deleted or altered using control signals received from the operations center **202** or cable headend **208**.

Once the menu templates have been stored in memory, the set top terminal **220** can generate the appropriate menus. In the preferred embodiment, the basic menu format information is stored in memory located within the set top terminal **220** so that the microprocessor may locally access the information from the set top terminal instead of from an incoming signal. The microprocessor next generates the appropriate menus from the menu templates and the other menu information stored in memory. The set top terminal **220** then displays specific menus on the subscriber's television screen that correspond to the inputs the subscriber selects.

If the subscriber selects a specific program from a menu, the set top terminal **220** determines on which channel the program is being shown, demultiplexes and extracts the single channel transmitted from the cable headend **208**. The set top terminal **220** then decompresses the channel and, if necessary, converts the program signal to an analog NTSC signal to enable the subscriber to view the selected program. The set top terminal **220** can be equipped to decompress more than one program signal, but this would unnecessarily add to the cost of the unit since a subscriber will generally only view one program at a time. However, two or three decompressors may be desirable to provide picture-on-picture capability, control signal decompression, enhanced channel switching or like features.

In addition to menu information, the set top terminal **220** may also store text transmitted from the cable headend **208** or the operations center **202**. The text may inform the subscriber about upcoming events, billing and account status, new subscriptions, or other relevant information. The text will be stored in an appropriate memory location depending on the frequency and the duration of the use of the textual message.

Also, optional upgrades are available to enhance the performance of a subscriber's set top terminal **220**. These upgrades may consist of a cartridge or computer card (not shown) that is inserted into an expansion slot in the set top terminal **220** or may consist of a feature offered by the cable headend **208** or operations center **202** to which the user may subscribe. Available upgrades may include on line data base services, interactive multi-media services, access to digital radio channels, and other services.

In the simplest embodiment, available converter boxes such as those manufactured by General Instruments or Scientific Atlanta, may be modified and upgraded to perform the functions of a set top terminal **220**. The preferred upgrade is a circuit card with a microprocessor which is electronically connected to or inserted into the converter box.

6. Remote Control Device

The primary conduit for communication between the subscriber and the set top terminal **220** is through the subscriber interface, preferably a remote control device **200**. Through this interface, the subscriber may select desired

programming through the system's menu-driven scheme or by directly accessing a specific channel by entering the actual channel number. Using the interface, the subscriber can navigate through a series of informative program selection menus. By using menu-driven, iconic or alpha-character access, the subscriber can access desired programs by simply pressing a single button rather than recalling from memory and pressing the actual channel number to make a selection. The subscriber can access regular broadcast and basic cable television stations by using either the numeric keys on the remote control **900** (pressing the corresponding channel number), or one of the menu icon selection options.

In addition to enabling the subscriber to easily interact with the cable system **200**, the physical characteristics of the subscriber interface **900** should also add to the user friendliness of the system. The remote control **900** should easily fit in the palm of the user's hand. The buttons of the preferred remote control **900** contain pictorial symbols that are easily identifiable by the subscriber. Also, buttons that perform similar functions may be color coordinated and consist of distinguishing textures to increase the user friendliness of the system.

7. Menu-Driven Program Selection

The menu-driven scheme provides the subscriber with one-step access to all major menus, ranging from hit movies to sport specials to specialty programs. From any of the major menus, the subscriber can in turn access submenus and minor menus by cursor or alpha-character access.

There are two different types of menus utilized by the preferred embodiment, the Program Selection menu and the During Program menus. The first series of menus, Program Selection menus, consists of an Introductory, a Home, Major menus, and Submenus. The second series of menus, During Program menus, consists of two primary types, Hidden menu and the Program Overlay menu. Immediately after the subscriber turns on the set top terminal **220**, the Introductory menu welcomes the subscriber to the system. The Introductory menu may display important announcements from the local cable franchise, advertisements from the cable provider, or other types of messages. In addition, the Introductory menu can inform the subscriber if the cable headend **208** has sent a personal message to the subscriber's particular set top terminal **220**.

After the Introductory menu has been displayed the subscriber may advance to the next level of menus, namely the Home menu. In the preferred embodiment, after a certain period of time, the cable system will advance the subscriber by default to the Home menu. From the Home menu, the subscriber is able to access all of the programming options. The subscriber may either select a program directly by entering the appropriate channel number from the remote control **900**, or the subscriber may sequence through incremental levels of menu options starting from the Home menu. The Home menu lists categories that correspond to the first level of menu called Major menus.

If the subscriber chooses to sequence through subsequent menus, the subscriber will be forwarded to the Major menu that corresponds to the chosen category from the Home menu. The Major menus further refine a subscriber's search and help guide the subscriber to the selection of his choice.

From the Major menus, the subscriber may access several submenus. From each submenu, the subscriber may access other submenus until the subscriber finds a desired television program. Similar to the Major menu, each successive level of Submenus further refines the subscriber's search. The system also enables the subscriber to skip certain menus or

submenus and directly access a specific menu or television program by entering the appropriate commands on the remote control **900**.

The During program menus (including Hidden Menus and Program Overlay Menus) are displayed by the set top terminal **220** only after the subscriber has selected a television program. In order to avoid disturbing the subscriber, the set top terminal **220** does not display the Hidden Menus until the subscriber selects the appropriate option to display a Hidden Menu. The Hidden Menus contain options that are relevant to the program selected by the viewer. For example, a Hidden Menu may contain options that enable a subscriber to enter an interactive mode or escape from the selected program.

Program Overlay Menus are similar to Hidden Menus because they occur during a program and are related to the program being viewed. However, the Program Overlay Menus are displayed concurrently with the program selected by the subscriber. Most Program Overlay Menus are small enough on the screen to allow the subscriber to continue viewing the selected program comfortably.

B. Detailed Set Top Terminal Description

The set top terminal **220** receives and manipulates signals from the cable headend **208**. The set top terminal **220** is equipped with local computer memory and the capability of interpreting the digitally compressed signal to produce menus for the subscriber. The remote control **900** communicates the subscriber's selections to the set top terminal **220**. The subscriber's selections are generally based upon menus or other prompts displayed on the television screen,

It is preferred that the signal reaches the subscriber's home in a compressed format and is decompressed prior to viewing. Included in the delivered program signal is information that enables equipment at the subscriber's home to display menus for choosing particular programs. Depending on the particular embodiment, the television program signal may arrive at the subscriber's home through one or more connections such as coaxial cables, fiber cables, twisted pairs, cellular telephone connections, or personal communications network (PCN) hookups.

The program control information signal is generated by the operations center **202** and provides the network controller **214** with data on the scheduling and description of programs. In an alternate configuration, this data is sent directly to the set top terminal **220** for display to the subscriber. In the preferred embodiment, the program control information signal is stored and modified by the network controller **214** and sent to the set top terminal **220** in the form of a set top terminal control information stream (STTCIS). The set top terminal **220** integrates either the program control information signal or the STTCIS with data stored in the memory of the set top terminal **220** to generate on-screen menus that assist the subscriber in choosing programs for display.

The types of information that can be sent using the program control signal include: number of program categories, names of program categories, what channels are assigned to a specific category (such as specialty channels), names of channels, names of programs on each channel, program start times, length of programs, description of programs, menu assignment for each program, pricing, whether there is a sample video clip for advertisement for the program, and any other program, menu or product information.

With a minimal amount of information being communicated to the set top terminal **220** on a regular basis, the set

top terminal **220** is able to determine the proper menu location for each program and the proper time and channel to activate for the subscriber after a menu selection. The program control information signal and STTCIS can be formatted in a variety of ways and the on-screen menus can be produced using many different methods. For instance, if the program control information signal carries no menu format information, the menu format for creating the menus can be fixed in ROM at the set top terminal **220**. In the preferred embodiment, the menu format information is stored at the set top terminal **220** in a temporary memory device such as a RAM or EPROM. New menu format information is sent via the program control information signal or the STTCIS to the set top terminals **200** whenever a change to a menu format is desired.

In the simplest embodiment, the menu formats remain fixed and only the text changes. In this way the program control information signal can be limited to primarily text and a text generator can be employed in the set top terminal **220**. Another simple embodiment uses a separate channel full-time (large bandwidth) just for the menu information.

Live video signals may be used in windows of certain menus. These video signals can be transmitted using the program control information signal or STTCIS, or can be taken off channels being transmitted simultaneously with the menu display. Video for menus, promos or demos may be sent to the set top terminal **220** in several formats, including (1) on a dedicated channel, (2) on a regular program channel and scaled to size, or (3) along with the program control information signal. However, in the preferred embodiment, a large number of short promos or demo video is sent using a split screen technique on a dedicated channel. A multiple window technique may be used with the menus to display a description of a program and one or more video frames that assist the subscriber in selecting the program.

FIG. 4 shows the basic hardware components of the set top terminal **220**. The set top terminal **220** has a tuner **603**, digital demodulator **606**, decryptor **600**, and demultiplexers **609**, **616** as well as audio equipment **612** and a remote control interface **626** for receiving and processing signals from the remote control unit **900**. An optional modem **627** allows communication between a microprocessor **602** and the cable headend **208**. An NTSC encoder **625** provides a standard NTSC video output.

The microprocessor **602** is capable of executing program instructions stored in memory. These instructions allow a user to access various menus by making selections on the remote control **900**.

The manner in which the video is decompressed and the menus are generated from the program control information signal or STTCIS varies depending on the specific embodiment of the invention. Video decompressors **618** and **622** may be used if the video is compressed. The program control information signal may be demultiplexed into its component parts, and a video decompressor **618**, graphic decompressor, text generator and video combiner **624** may be used to assist in creating the menus.

In addition to the menu format information that is stored in graphics memory, the set top terminal **220** also stores data, tracking those programs that have been selected for viewing. By gathering this data, the set top terminal **220** can maintain an accurate record of all programs accessed/watched by storing the data in EEPROM or RAM. Subsequently, this data can be transmitted to the cable headend **208**, where it can be used in carrying out network control and monitoring functions. Such data transmissions between the set top

terminal **220** and cable headend **208** can be accomplished, for example, through upstream transmission over the cable network or over telephone lines through the use of telephone modems. Where upstream transmission over the cable network is used, the set top terminals **220** can complete data transmissions on a scheduled (e.g., using a polling response or status report to respond to polling requests sent from the cable headend **208**) or as-needed (e.g., using a random access technique) basis.

FIG. **5a** shows the front panel of the set top terminal **220**, which includes an infrared sensor **630** and a series of LED displays **640**. The LED displays **640** may indicate with an icon or a letter (e.g. A-K) the major menu currently selected by the set top terminal **220** or the channels selected directly by a user, or menu channel selections (e.g., from 1 to 50). Further displays may include current channel, time, volume level, sleep time, parental lock (security), account balance, use of a hardware upgrade, second channel being recorded by VCR, use of the Level D music hardware upgrade in a separate room, and any other displays useful to a subscriber to indicate the current status of the set top terminal **220**. The LEDs **640** may also provide an indication of the digital audio channel currently tuned.

The set top terminal **220** includes a flapped opening **635** on its front that allows the insertion of a magnetic cartridge (or similar portable storage device, including optical disk, ROM, EPROM, etc. not shown). This cartridge opening **635** allows the set top terminal **220** to be upgraded or reprogrammed locally with the use of a magnetic tape cartridge.

On the top or cover of the set top terminal **220** are located pushbutton controls **645**. Any function that can be performed on the remote **900** may also be performed at the set top terminal **220** using the duplicative pushbutton controls **645**.

FIG. **5b** shows the back of the set top terminal **220**, which includes a pair of output terminals **650**, pair of input terminals **652**, pair of stereo/audio output terminals **654**, satellite dish input port **656**, telephone jack **658** and an RS-422 port **660**. In addition, an upgrade port **662** and a cover plate **664** are held in place by a series of sheet metal screws. One of the output terminals **650** is for a television and the other is for a VCR. The set top terminal **220** is equipped to handle incoming signals on one or two cables using the input terminals **652**. The phone jack **658** and an RS-232 or RS-422 port **660** are provided for maintenance, trouble shooting, reprogramming and additional customer features. In alternate embodiments, the telephone jack **658** may be used as the primary mode of communication between the cable headend **208** and the set top terminal **220**. This connection is possible through the local telephone, cellular telephone or a personal communications network (PCN).

The basic programming of each set top terminal **220** is located on ROM within the set top terminal **220**. Random access memory, the magnetic cartridge capability, and the expansion card slot **635** each allow upgrades and changes to be easily made to the set top terminal **220**.

In the preferred embodiment, the set top terminal **220** includes a hardware upgrade port **662**, in addition to expansion card slots. The hardware upgrade port **662** accommodates a four-wire (or more) connection for: (1) error corrected, decrypted data output of the set top terminal **220**, (2) a control interface, (3) decompressed video output, and (4) a video input port. In the preferred embodiment, multiple wires are used to perform each of the four functions. The four sets of wires are combined in a single cable with a single multipin connector.

In the preferred embodiment, multipin connections may be used for the multiwire cable. The multipin connection **662** may range from DB9 to DB25. A variety of small computer systems interface (SCSI) ports may also be provided. Alternatively, four or more ports may be provided instead of the single port depicted.

Another port **662** is used to attach the various hardware upgrades described below to a set top terminal **220**. The preferred embodiment has a number of hardware upgrades available for use with a set top terminal **220**, including: (1) a Level A interactive unit, (2) a Level B interactive unit, (3) a Level C interactive unit with compact disc capability, (4) a Level D digital radio tuner for separate room use, and (5) a Level E information download unit. Each of these upgrades may be connected to the set top terminal **220** unit through the upgrade port **662** described earlier. The same four wires in a single cable described earlier may be used.

Existing set top converter boxes such as those made by Scientific Atlanta or General Instruments are presently unequipped to handle the menu selection system of the present invention. Thus, hardware modifications are necessary in order to use the menu selection system with existing set top converter technology.

A Turbo Card addition to a set top converter is depicted in FIG. **6**. The Turbo Card **700** shown provides the additional functionality needed to utilize the menu system with existing set top converter technology. The primary functions the Turbo Card **700** adds to the set top converter are the interpreting of program control information signs, generating of menus, sequencing of menus, and, ultimately, the ability of the viewer to select a channel through the menu system without entering any channel identifying information. The turbo card also provides a method for a remote location, such as the cable headend **208**, to receive information on programs watched and control the operation of the set top converter and Turbo Card **700**. The programs watched information and control commands may be passed from the cable headend **208** to the Turbo Card **700** using telephone lines.

The primary components of the Turbo Card **700** are a PC chip CPU **702**, a VGA graphic controller **704**, a video combiner **706**, logic circuitry **708**, NTSC encoder **710**, a receiver **712**, demodulator **714**, and a dialer **716**. The Turbo Card **700** operates by receiving the program control information signal from the cable headend **208** through the coaxial cable. The logic circuitry **708** of the Turbo Card **700** receives data, infrared commands, and synchronization signals from the set top converter. Menu selections made by the viewer on the remote control **900** are received by the set top converter's IR equipment and passed through to the Turbo Card **700**. The Turbo Card **700** interprets the IR signal and determines the program (or menu) the viewer has selected. The Turbo Card **700** modifies the IR command to send the program selection information to the set top converter **221**. The modified IR command contains the channel information needed by the set top converter. Using the phone line and dialer **716**, the Turbo Card **700** is able to transmit program access information to the cable headend **208**.

In the preferred embodiment, program access information, that is what programs the viewer watched, is stored at each set top terminal **220** until it is polled by the network controller **214** using a polling request message format as shown in FIG. **7a**. This frame format **920** consists of six fields, namely: (1) a leading flag **922** at the beginning of the message, (2) an address field **924**, (3) a subscriber region designation **926**, (4) a set top terminal identifier **928**

that includes a polling command/response (or P/F) bit **930**, (5) an information field **932**, and (6) a trailing flag **934** at the end of the message. FIG. 7b shows a response frame format **920'** (similar to the frame format **920** end, therefore, commonly numbered with the frame depicted in FIG. 7a, but with the prime indicator added for clarity) for information communicated by the set top terminal **220** to the network controller **214** in response to the polling request of FIG. 7a.

The eight-bit flag sequence **922** that appears at the beginning and end of a frame is used to establish and maintain synchronization. Such a sequence typically consists of a "01111110" bit-stream. The address field **924** designates a 4-bit address for a given set top terminal **220**. The subscriber region designation **926** is a 4-bit field that indicates the geographical region in which the subscriber's set top terminal **220** is housed. The set top terminal identifier **928** is a 16-bit field that uniquely identifies each set top terminal **220** with a 15-bit designation followed by an appended P/F bit **930**. Although field size is provided by this example, a variety of sizes can be used with the present invention.

The P/F bit **930** is used to command a polling response from the set top terminal **220** addressed, as described below. The response frame format **920'** also provides a variable-length information field **932'** for other data transmissions, such as information on system updates. The frame format **920'** ends with an 8-bit flag (or trailing sag) **934'** that is identical in format to the leading flag **922'**, as set forth above. Other frame formats (e.g., MPEG) will be apparent to one skilled in the art and can be easily adapted for use with the system.

As summarized above, images or programs may be selected for display by sequencing through a series of menus. FIG. 8 is an example of one possible structure for a series of menus. Generally, the sequence of menus is structured with an introductory menu, a home menu, various major menus and a multitude of submenus. The submenus can include promo menus and during program menus. For example, at the home menu portion of the sequence of menus and corresponding software routines, a subscriber may select one of the major menus and start a sequence of menu displays. Alternatively, a subscriber may go directly to a major menu by depressing a menu select button on remote control **900**.

At any time during the menu sequence, the subscriber may depress a major menu button to move into another series of menus. In this way, a subscriber may move from major menu to major menu.

The various software subroutines executed by the microprocessor **602** allow a subscriber to sequence the menus, navigating through the various menus of the present invention. A subscriber may sequence back through menus or return to the home menu with a single touch of the home menu button on remote **900**.

An introductory menu screen **1000** automatically appears upon power-up and initialization of the set top terminal **220**. From this introductory menu screen **1000**, the set top terminal software will normally advance the subscriber to the home menu screen **1010**. The home menu **1010** is the basic menu that the subscriber will return to in order to make the first level of viewing decisions. When the set top terminal software is displaying the home menu **1010**, the subscriber is able to access any television programming option. The software allows programming options to be entered through cursor movement on the screen and directly by button selection on the remote control **900**.

In the normal progression through the menu screens, the software will forward the subscriber to a major menu screen

1020 in response to the subscriber's remote control **900** selection or highlighted cursor selection from the home menu screen **1010**. The selections displayed on the home menu **1010** are for large categories of programming options.

Following the major menu **1020**, the subscriber may navigate through one or more submenu screens **1050** from which the subscriber may choose one particular program for viewing. For most programming selections, the user will proceed from the home menu **1020** to a major menu **1020** and then to one or more submenus **1050**. However, for certain programming options or functions of the set top terminal **220**, the user may skip one or more menus in the sequence.

The During Program Menus **1200** are submenus enabled by the set top terminal software only after the subscriber has selected a television program. These menus provide the subscriber with additional functionality and/or additional information while viewing a selected program. The During Program Menus **1200** sequence can be further subdivided into at least two types of menus, Hidden Menus **1380** and Program Overlay Menus **1390**.

To avoid disturbing a subscriber during viewing of a program, the Hidden Menus **1380** are not shown to the subscriber but instead "reside" at the set top terminal **220** microprocessor **602**. The microprocessor **602** awaits a button entry either from the remote control **900** or set top terminal **220** buttons before executing or displaying any Hidden Menu **1380** options. The set top terminal software provides the subscriber with additional functions such as entering an interactive mode or escaping from a selected program through use of Hidden Menus **1380**.

Program Overlay Menus **1390** are similar to Hidden Menus **1380**. However, the Program Overlay Menus **1390** are overlayed onto portions of the displayed video and not hidden. The software for the Program Overlay Menus **1390** allows the subscriber to continue to watch the selected television program with audio but places graphical information on a portion of the television screen. Most Program Overlay Menus **1390** are graphically generated to cover small portions of video. Some Overlays **1390** which are by their nature more important than the program being viewed will overlay onto greater portions of the video. Examples of types of overlay menus **1390** include Notification Menus **1392** and Confirmation Menus **1394**. In the preferred embodiment, the software for the Program Overlay Menus **1390** controls the reduction or scales down the (entire) programs video and redirects the video to a portion of the screen.

Submenus provide the cost of viewing the program and the program's length in hours and minutes. From the submenus, the subscriber is given at least three options: (1) to purchase a program, (2) to return to the previous menu, and (3) to press "go" and return to regular TV. The subscriber may also be given other options such as previewing the program.

Using an on-screen menu approach to program selection, there is nearly an unlimited number of menus that can be shown to the subscriber. The memory capability of the set top terminal **220** and the quantity of information that is sent using the program control information signal are the only limits on the number of menus and amount of information that can be displayed to the subscriber. The approach of using a series of menus in a simple tree sequence as both easy for the subscriber to use and simply implemented by the set top terminal **220** and remote control device **900** with cursor movement. A user interface software programmer

will find many obvious variations from the preferred embodiment described.

The set top terminal **220** generates and creates menus using, in part, information stored in its graphics memory. A background graphics file **800** will store menu backgrounds and a logo graphics file will store any necessary logos. A menu display and cursor graphics file will store menu display blocks and cursor highlight overlays as well as any other miscellaneous files needed to build the menus. Using this method of storing menus, the menus can be changed by reprogramming the graphics memory of the set top terminal **220** through instructions from either the network controller **214** or operations center **202**.

The microprocessor **602** performs the steps required to create a menu using stored information. The microprocessor **602** fetches a background file, logo file, menu display and cursor file in most instances. The microprocessor **602** fetches text from long-term, intermediate-term, or short-term storage depending on where the text is stored. Using a video combiner (or like device), the stored information is combined with video and the entire image is sent to the television screen for display.

In the preferred embodiment, a graphics controller is used to assist the set top terminal **220** in generating menus. Menu generation by the set top terminal **220** begins with the building of a major menu screen, which includes background graphics for that major menu. The background graphics may include an upper sash across the top of the screen and a lower sash across the bottom of the screen. The background graphics may be generated from the background graphics file **800** in the memory files of the graphics memory (preferably EEPROM). In addition, logo graphics may be generated. Such graphics typically include an icon window, a cable company logo, a channel company logo, and two "go" buttons.

Preferably, the text for each major menu is generated separately by a text generator in the set top terminal **220**. Those portions of the text that generally remain the same for a period of weeks or months may be stored in EEPROM or other local storage. Text which changes on a regular basis, such as the movie titles (or other program selections), is transmitted to the set top terminal **220** by either the operations center **202** or the network controller **214** of the cable headend **208**. In this manner, the cable headend **208** may change the program selections available on any major menu **1020** by modifying the program control information signal sent by the operations center **202** and transmitting any changes using the STTCIS.

Day, date and time information are added to each major menu. This information is sent from the operations center **202**, the cable headend **208** (signal processor **209** or network controller **224**), the uplink site, or generated by the set top terminal **220** internally.

The creation and display of program description submenus is performed by the set top terminal **220** in a manner similar to that described above. Each submenu may be created in parts and combined before being sent to the television screen. Preferably, background graphics and upper and lower sashes are used. Likewise, a video window and half-strip window can be generated from information in storage on the EEPROM.

In addition to graphics and text, some submenus include windows that show video. Such video may be still or moving

pictures. Still pictures may be stored in a compressed format (such as JPEG) at the set top terminal **220**. Video stills may be transmitted by the operations center **202** through the program control information signal from time to time.

Moving video picture is obtained directly from a current video feed as described above. Depending on video window size, this may require manipulation of the video signal, including scaling down the size of the video and redirecting the video to the portion of the menu screen which is within the video window of the menu. Alternatively, the video may be obtained from a split screen channel. Such a method involves the use of split screen video techniques to send multiple video clips on a single channel at a given time. The set top terminal **220** would scale the picture, if necessary, and redirect it to the correct position on the screen using known scaling and positioning techniques. Additional circuitry may be required in the set top terminal **220** to perform adequate scaling and repositioning.

To avoid the need for redirecting video into the portion of the screen which houses the video window, masking and menu graphics may be used to cover the portions of the channel video that are not needed. This masking technique allows the split screen video to remain in the same portion of the screen that it is transmitted by the operations center **202**. The masking is then adjusted to cover the undesired portions of the screen. These masks are stored in the background graphics file similarly to other background files for menus.

The split screen video technique may also be used for promoting television programming. Since a great number of short video clips may be sent continuously, full or partial screen promotionals (or informationals) may be provided to the subscriber. With this large quantity of promotional video, the subscriber is given the opportunity to "graze" through new movie or television programming selections. The subscriber simply grazes from promotional video to promotional video until the desired television program is discovered.

C. Detailed Description of Advanced Set Top Terminal

1. Overview

The present invention relates to advances in the set top terminal **220** described above. In particular, the present invention may be achieved through a set of hardware upgrades or additions to the following embodiments: (1) an existing set top converter (not shown) upgraded with a Turbo Card **700** or the like; (2) an industry standard digital decompression converter box (as shown in FIGS. **9a** and **9b** below) upgradeable by either an upgrade module or a menu generation card, or (3) a set top terminal **220** capable of both decompression and menu generation. The set of hardware upgrades described below can be used to provide additional advanced features and functional capabilities to any of these embodiments.

Table A shows several exemplary hardware configurations that may be used to achieve the goals of the present invention. In particular, Table A shows four columns of set top converter technology, which may be modified to produce the various set top capabilities shown in the three rows of the table

TABLE A

	Existing Analog Set Top Converter	Set Top Converter With Digital Decompression Capability	Set Top Converter With Digital Decompression and Menu Generation Capabilities	Advanced Set Top Terminal
Decompression Capability	N/A	Built-In	Built-In	Built-In
Menu Generation Capability	Turbo Card	Upgrade Module or Menu Generation Card	Built-In	Built-In
Advanced Features	Level A-C Hardware Upgrades or Expansion Card	Level A-E Hardware Upgrades or Expansion Card	Level A-E Hardware Upgrades or Expansion Card	Built-In

The table shows the various inherent functional capabilities of each set top converter, and how each may be modified or upgraded, if necessary, to achieve the objectives of the present invention. From left to right, the columns of the table span the various alternatives for balancing those capabilities that may be built into set top converters or terminals, on the one hand, and those capabilities that can be provided through, for example, an upgrade module, expansion card or hardware upgrade of the present invention, on the other. This balance allows a designer or manufacturer of set top converters to choose between adding advanced functionality to an existing converter box or, instead, producing a converter with additional built-in features that increase cost and complexity of the converter or terminal.

The first column of Table A shows how an existing analog set top converter can be modified to provide menu generation capability through the use of the Turbo Card. In addition to the Turbo Card, such an existing analog set top converter may be further modified to provide any of the advanced features described below through the use of the Level A, Level B and Level C hardware upgrades or an expansion card. Such existing set top converter boxes are currently manufactured by Scientific Atlanta and General Instruments, among others. These converter boxes have been designed for use with analog waveforms and, as a result, digital decompression capabilities are not applicable.

The second column of Table A shows a set top converter with digital decompression capability. This converter is a simple decompression box which may eventually become the industry standard. The simple decompression boxes may be modified to provide the enhanced functionality of the present invention. For example, a simple decompression box may be modified to produce menu generation capability through the use of an upgrade module or menu generation card. In addition, other advanced features may be added to a simple decompression box through modifications that include any of the Level A through E hardware upgrades or an expansion card. Each of these modifications are described below.

The third column of Table A shows a set top converter that has built-in digital decompression and menu generation capabilities. Thus, in order to achieve the enhanced functionality of the present invention, other advanced features may be provided through hardware modification. Such modification may be accomplished through the use of any of the Level A through E hardware upgrades or the expansion card, as explained below.

The fourth column of Table A shows an advanced set top terminal having decompression, menu generation, and advanced functional capabilities. Each of these capabilities are built in to the terminal itself. In this way, achieving the enhanced performance of the set top terminal in accordance with the present invention would require no hardware modification.

15

In the preferred embodiment, the advanced set top terminal 220 of the present invention has the capability, among other things, of receiving tiered programming from the network controller. Tiered programming allows different users to view different video even though the subscribers are “tuned” to the same channel. For example, the network controller 214 may know the demographics of its subscribers through a database, by “learning” from prior subscriber choices, from an interactive selection, or from other means. Using the demographics information, the network controller 224 may target commercials to the correct audience by showing different commercials to subscribers with different demographics. Even though subscribers will believe they are “tuned” to one channel, each subscriber will be switched to a different channel for the tiered video. Alternatively, subscribers may be offered an option of several commercials from which to choose.

20

25

30

35

40

45

To accommodate foreign speaking subscribers, multiple audio channels for television programming may be provided. In this way, the subscriber may be shown menus of programs available in the subscriber’s native language. The function of choosing the correct audio to correspond to the selected language may be handled by either the set top terminal 220 or the network controller 214 depending upon the configuration. Local programming in several languages or additional audio channels for a foreign language translation of a popular television program may be provided by the network controller 214. Using a picture-on-picture feature, sign language may be similarly made available to certain set top terminals 220 for the deaf. Also, a text overlay may easily be produced on the lower part of the screen for the deaf.

50

55

60

Typically, each video signal is received at the set top terminal 220 along with four audio channels. Two of these audio channels will preferably be used for left and right stereo audio reception of the video signal being displayed. The remaining two audio signals may be used for alternative languages. For example, where a video signal is received by the set top terminal 220, two of the audio channels will provide the stereo audio signals for that video in English, with the other two audio channels providing mono audio signals in French and Spanish. In this way, each video signal received at the set top terminal 220 can accommodate at least two foreign languages. Where stereo audio channels are not desired, the audio channels in English can be set to a single signal, providing mono audio reception, and increasing the multiple language audio channel capability to three foreign languages.

65

In other embodiments, the network controller 214 can act as a central computer and provide intra-set top terminal interactive games, inter-set top terminal interactive games, computer bulletin board type services, message services

(Electronic mail) etc. For example, a subscriber may play war games with five (anonymous) fellow subscribers each in their own home each operating a separate tank. The network controller 224 gathers the players via set top terminal 220 communications and acts as the referee. A bulletin board or message system can be set up to discuss a particular program such as "Twin Peaks Whodunit" for enthusiasts. These interactive features are further described below with the interactive services level B menu and the set top terminal hardware upgrade Level B interactive unit.

In order to achieve the required throughput of video and audio information for the system, digital compression is techniques for video are employed. As a result, the set top terminal 220 typically must decompress any digitally compressed program signals that it receives. Methods of decompression are a function of the compression technique used in the program delivery system.

There are three basic digital compression techniques: within-frame (intraframe), frame-to-frame (interframe), and within-carrier compression. Various compression methods may be used with these techniques. Such methods of compression, which include vector quantization and discrete cosine transform methodologies, are known to those skilled in the art.

Several standard digital formats representing both digitizing standards and compression standards have also been developed. For example, JPEG (joint photographic experts group) is a standard for single picture digitization. Motion picture digitization may be represented by standards such as MPEG or MPEG 2 (motion picture engineering group specification). In addition to these standards, other proprietary standards have been developed. Although MPEG and MPEG 2 for motion pictures are preferred in the present invention, any reliable digital format with compression may be used.

Various hybrids of the above compression techniques and methods have been developed by several companies including AT&T, Compression Labs, Inc., General Instruments, Scientific-Atlanta, Philips, and Zenith. Any of the compression techniques developed by these companies, as well as other techniques known to those skilled in the art, may be used with the present invention.

2. Advanced Set Top Terminal Major Components and Upgrades

a. Decompression Box with Upgrade Module

The preferred program delivery system uses digitally compressed signals and, as a result, the preferred subscriber equipment configuration must be capable of decompressing and processing such digitally compressed signals. FIG. 9a diagrams the basic interplay between an upgrade module 300 and a simple decompression box 302. The upgrade module 300 can be connected to the decompression box 302 through a port similar to the upgrade port 662 described above (FIG. 5b). The simple decompression box 302 shown is preferably a future industry standard decompression box capable of communicating with an upgrade module 300 to enhance functionality.

The upgrade module 300 provides menu generation capability to the simple decompression box 302. The microprocessor of the simple decompression box 302 communicates with the microprocessor in the upgrade module 300 to provide the full functionality of a set top terminal 220.

In the preferred embodiment, multipin connections may be used for a multiwire cable connecting the simple decompression box 302 with the upgrade module 300. The multipin connection may range from DB9 to DB25. A SCSI, or

small computer systems interface, port (not shown) may also be provided. Alternatively, four or more ports may be provided instead of the single port depicted. If a port is not provided, the upgrade module may, alternatively, be hard-wired to the simple decompression box 302.

As represented generally at 304, the digital data set of output wires of the simple decompression box 302 will preferably output error corrected and decrypted data to the upgrade module 300. The second set of wires, providing the interface connection, allows the microprocessor in the upgrade module 300 to communicate with the microprocessor of the simple decompression box 302. In this manner, the video circuitry of the upgrade module 300 and the simple decompression box 302 may maintain synchronization. The third set of wires, providing the decompressed video output, provide the upgrade module 300 with a decompressed video signal to manipulate. The fourth set of wires, comprising the video input set, allows the simple decompression box 302 to accept a video signal that is a combined text, graphics, and video signal.

FIG. 9a further shows the CATV input 306, video input 308, and video and audio outputs 310, 312, as part of the simple decompression box 302. This embodiment reduces the component cost of upgrade module 300, and thus, is preferred. The upgrade module 300 may simply be a cartridge (not shown) insertable into the simple decompression box 302. Alternatively, as shown in commonly numbered FIG. 9b, the CATV input 306, video input 308 and video and audio outputs 310, 322 may be included as part of the upgrade module 300. In this embodiment, the simple decompression box 302 is primarily used for decompressing the video.

Referring to FIG. 10, the upgrade module 300 preferably includes the following circuitry: a video graphics and text demultiplexer 314; a text and graphics video plane combiner 316; a run length graphics decompressor 318; and, a run length compressed graphics memory 319 (nonvolatile RAM, ROM, EPROM, or EEPROM). By means of communications through the multiwire connection between the upgrade module 300 and the simple decompression box 302, compressed video and control signals may be demultiplexed by the demultiplexer 314 within the upgrade module 300. The run length graphics decompressor 318, through communications with the run length compressed graphics RAM 319, permits decompression of the input compressed video signal. The text and graphics video plane combiner 316 allows demultiplexed and decompressed signals to be output, through the simple decompression box 302, to a subscriber's television 222 showing both video and overlay menus with text.

An example of a component that can be used for the combiner 316 is an IC GENLOCK Signal Processor GSP500, manufactured by Integrated Circuit Systems, Inc., located at 2626 Van Buren Avenue, P.O. Box 968, Valley Forge, Pa. 19482, (215) 666-1900. The combiner 316 performs several functions, including interpreting the demultiplexed text and graphics, integrating the interpreted text and the interpreted graphics to produce a menu generation signal which carries data required for display of the promotional menus or the program catalogue, and sending the menu generation signal to be output through the expansion card interface to the set top converter for display of the program catalogue, the promotional menus, and the promotional videos, text, and graphics.

FIG. 10 shows the elements of a simple decompression box 302 (numbered commonly with the elements of the set top terminal 220 depicted in FIG. 4) with the upgrade

module **300** described above. Generated menus and video are combined in the combiner **316** and output to an antitaping encoder **619**. Any method of antitaping encoding known by those skilled in the art may be used with the present invention.

FIG. **10** also depicts an expansion card **320** and an expansion card interface **322** for receiving the card **320**. In addition, error correction circuitry **324** is shown receiving the demodulated signal, prior to demultiplexing the signal.

The enhanced functionality of the upgrade module **300** may alternatively be included on the expansion card **320**. In this embodiment, the upgrade module **300** becomes an internal component of the simple decompression box **302** and internally upgrades the box **302** to include menu generation capability without using an external upgrade module **300**. Other variations in the upgrade module **300** configuration are also possible.

b. Upstream Data Transmission Hardware

FIG. **11** shows a preferred set top terminal **220** that includes a data receiver **332** and a data transmitter **344**. The data transmitter **344** provides upstream data communications capability between the set top terminal **220** and the cable headend **208**. Upstream data transmissions are accomplished using the polling system described with reference to FIGS. **7a** and **7b** above, and, in particular, using a data transmitter **344**. Both receiver **332** and transmitter **344** may be built into the set top terminal **220** itself or added through an upgrade module **300**. Regardless of the specific hardware configuration, the set top terminal's data transmission capabilities may be accomplished using the hardware shown in FIG. **11**.

FIG. **11** shows RF signals, depicted at **330**, being received at by a data receiver **332** and tuner **603** working in unison. Both of these devices are interfaced with the microprocessor **602**, which receives inputs, depicted at **338**, from the subscriber, either through the set top terminal's keypad **645** or remote control unit **900**. All cable signals intended for reception on the subscriber's TV are accessed by the tuner **603** and subsequently processed by the processing circuitry **340**. This processing circuitry **340** typically includes additional components for descrambling, demodulation, volume control and remodulation on a Channel **3** or **4** TV carrier.

Data targeted to individual set top terminals **220** is received by the data receiver **332** according to each set top terminal's specific address or ID (e.g. set top ID **928**, **928'**). In this way, each addressable set top terminal **220** only receives its own data. The data receiver **332** may receive set top terminal specific data in the information field of the program control information signal frame, described with reference to FIG. **7a** or on a separate data carrier located at a convenient frequency in the incoming spectrum.

Any received data includes information regarding channels and programs available for selection. The subscriber may enter a series of commands using the keypad **645** or remote control **900** in order to choose a channel or program. Upon receipt of such commands, the set top terminal's microprocessor **602** instructs the tuner **603** to tune to the proper frequency of the channel or program desired and subsequently instructs the processing circuitry **340** to begin descrambling of this channel or program.

Upon selection of a channel or program, the microprocessor **602** stores any selection information in local memory for later data transmission back to the cable headend **208**. Typically, the data transmitter **344** operates in the return frequency band between 5 and 30 MHz. In an alternative embodiment, the frequency band of 10 to 15 MHz may be used. Regardless, however, of the frequency band used, the

data transmitter **344** sends information to the cable headend **208** or network controller **214** in the information field of the frame described with reference to FIG. **7b**. Those skilled in the art will recognize that a number of variations and combinations of the above-described set top terminal **220** hardware components may be used to accomplish upstream data transmissions.

c. Hardware Upgrades

In order to enhance a set top terminal's **220** functionality, the following hardware upgrades may be used: (1) a Level A interactive unit, (2) a Level B interactive unit, (3) a Level C interactive unit with compact disc capability, (4) a Level D digital radio tuner for separate room use, and (5) a Level E information download unit. Each of these upgrades is connected to the set top terminal **220** unit through the upgrade port **662** described earlier.

Level A, B and C hardware upgrades have similar hardware components. FIG. **12a** diagrams the basic components of the Level A, B and C hardware upgrades, indicated generally at **100**. The figure diagrams the interaction between the hardware upgrades **100** and the set top terminal's **220** basic components. As seen in the figure, CATV input signals are received by the set top terminal **220** using a tuner **603** and various receiver components described above (but denoted generally at **601** in FIGS. **12a** and **12b**). The set top terminal's microprocessor coordinates all CATV signal reception and also interacts with various upstream data transmission components **604**, which have been described above.

The Level A, B and C hardware upgrades **100** each include a microprocessor **104**, interactive software **106**, processing circuitry **108**, bubble memory **112**, and a long-term memory device **116**. In addition to these basic components, the Level B hardware upgrade makes use of an additional telephone modem **120**, while the Level C hardware upgrade makes use of an additional CD-ROM storage device **122**.

Along with their basic components, the Level A, B and C hardware upgrades **100** each use their own interactive software **106**. This software may be used to provide the enhanced functional capabilities described below. The Level A, B and C hardware upgrades also make use of processing circuitry **108**, which allows the set top terminal **220** to pass the subscriber's interactive input to the Level A, B and C hardware upgrades **100** for interpretation. These commands are passed through the interface linking the set top terminal's microprocessor with the microprocessor of the Level A, B and C hardware upgrades **100**. In this way, subscriber inputs, entered through the set top terminal keypad or remote control, can be transferred to any of the hardware upgrades for processing and responses generated therein can then be sent back to the set top terminal **220** for display. In the preferred embodiment the IR commands are transferred from set top terminal to hardware upgrade.

The Level A, B and C hardware upgrades **100** also include a long-term memory component or device **116** that allows each hardware upgrade to internally store data used with each interactive service. Such data may include, for example, customized menu templates used by the individual Interactive services. In addition, the Level A, B and C hardware upgrades include a bubble memory **112** for the temporary storage of, for example, interactive questions and responses used in each particular interactive service.

The Level A interactive unit allows the subscriber to access interactive services offering additional information about programs such as quizzes, geographical facts, etc. This information may be received by the set top terminal **220** in

several data formats, including using the vertical blanking interval (VBI) or the program control information signal. The Level A interactive unit enables the subscriber to engage in textual interactivity with the current television program using overlay menus. Some examples are quizzes, fast facts, more info, where in the world, products, etc. all of which provide the subscriber with an interactive question and answer capability. Although the Level A interactive capability can easily be built into the set top terminal **220**, such an embodiment increases the cost of the basic set top terminal **220**.

The Level B interactive unit provides the user with access to online data base services for applications such as home shopping, airline reservations, news, financial services, classified advertising, home banking, and interactive teletext services. For example, with this upgrade, a user will be able to reserve plane tickets or buy consumer electronics. The primary feature of this upgrade unit is that it allows actual transactions using two-way communications over modem with outside services. This added two-way communications capability may be with the cable headend **208** or, alternatively, over cellular networks, PCN or other communications media.

The Level C interactive unit employs a high volume local storage capacity, including compact disc or other random access digital data formats (e.g., CD-ROM **122**). This unit allows use of interactive multi-media applications. Such applications include, for example, computer games, multi-media educational software, encyclopedias, other reference volumes (e.g. Shakespeare library), etc. In the preferred embodiment, many of these applications will interact with live programming providing additional information and interactivity to the basic program feed. For example, a viewer watching a show set in a foreign country may be able to retrieve additional information, maps, economic data, as well as other information about that country that are stored on the compact disc. In the Level C applications, the upgrade hardware may closely monitor the television broadcast through additional data channels (e.g., vertical blanking interval, or other digital data encoded within live video) providing context sensitive interactivity.

FIG. **12b** diagrams the interaction between the set top terminal **220** and the Level D hardware upgrade, indicated generally at **130**. As shown in the figure, the CATV signals are input to the set top terminal **220** through its tuner **603** and receiver components **601**. As described above, the microprocessor **602** coordinates all cable television signal reception by the set top terminal **220**. The Level D hardware upgrade **130** makes use of a microprocessor **132**, a tuner **134**, a demodulator **136**, a demultiplexer **138**, a decryptor **140** and an audio decompressor **142**.

As shown in the figure, the set top terminal **220** and the Level D hardware upgrade **130** interact through the interface linking the respective devices. The set top terminal's microprocessor **602** instructs received signals to be transferred to the Level D hardware upgrade **130** for further processing. These received signals are input to the Level D hardware upgrade, passed through the signal path comprising the tuner **134** and other digital audio reception components (i.e., demodulator **136**, demultiplexer **138**, decryptor **140** and audio decompressor **142**). Through the use of the hardware as configured in FIG. **12b**, the subscriber can select a digital audio program for listening. The subscriber can accomplish such selection through a subscriber interface (not shown), which may exist at the set top terminal **220** or, alternatively, at the Level D hardware upgrade.

The Level D hardware upgrade allows the subscriber separate access to the digital radio channels while other

programming (not necessarily radio) is being viewed on the television. Typically, this upgrade would be used for digital radio usage in a separate room from that of the television. The upgrade has a separate tuner, decompressor, and visual display. In the preferred embodiment a second remote control (which is preferably a scaled-down version of the set top terminal remote control, described below) is provided to access the digital audio system. This remote is equipped with a display.

The Level E hardware upgrade allows the subscriber to download large volumes of information from the operations center **202** or cable headend **208**. The Level E hardware upgrade will enable subscribers to download data, such as books and magazines, to local storage. Primarily, the Level E hardware upgrade is an additional local storage unit (e.g., hard disk, floppy, optical disk or magnetic cartridge). Preferably, a small portable reader, called "EveryBook™", is also provided with the upgrade to enable downloaded text to be read without the use of a TV. The portable reader is equipped with a screen.

The downloadable information may be text or video supplied by the operations center **202** or cable headend **208**. With this upgrade, books may be downloaded and read anywhere with the portable reader. Using this upgrade, video may be downloaded and stored in compressed form for later decompression. The video would be decompressed only at the time of viewing. Important text that the public desires immediate access may be made available through this system. Text such as the President's speech, a new law, or a recent abortion decision rendered by the Supreme Court may be made immediately available.

Using a more sophisticated port, such as the SCSI port, multiple hardware upgrade units may be connected, or "daisy-chained" together, to operate simultaneously. Although these upgrade units are described separately, the units may be combined or built into the set top terminal **220**. Those skilled in the art will recognize variations on such combinations of and additions to the set top terminal hardware.

d. Expansion Card Slot

In order to provide the greatest flexibility possible and prevent a set top terminal **220** from becoming outdated during the terminal's useful life, additional electronic expansion card slots have been built into the preferred embodiment. The expansion slots **665** (depicted in phantom in FIG. **5b**) are covered by the metal plate cover **664** as shown in FIG. **5b**. It is anticipated that additional memory or capabilities may be needed for certain customer features and also to update the system as the cable delivery system's capabilities increase.

In addition to providing an additional memory capability, the expansion card slot provides an easy method to upgrade the set top terminal hardware. In particular, expansion cards can be used to internally provide any of the Level A through E hardware upgrade features described above. Such embodiments, however, use the upstream data transmission hardware, also described above (or built-in modem).

Functionally, the expansion card (not shown) may be inserted into an expansion card slot **665**, causing a connector on the expansion card to electrically link with a card connector on the set top terminal **220**. Preferably, the frame of the set top terminal has a shelf or rack position to hold the expansion card. The card connector on the set top terminal **220** may simply be an electrical connection to the set top terminal's microprocessor and/or memory device or devices. Alternatively, the interface between the expansion card and the set top terminal **220** may be an electrical bus that allows

the memory resources of the set top terminal **220** to be directly expanded. In this case, the expansion card itself contains a memory device or devices that expand the amount of program information or data that the set top terminal **220** may access. Such memory devices include RAM, ROM, EPROM or EEPROM. In addition, the interface may be a "mailbox," which resides in the set top terminal **220** as a single memory location. This embodiment facilitates the transfer of data between the set top terminal **220** and the expansion card in either serial or parallel format. Such transfers are coordinated and controlled by the set top terminal's microprocessor **602**.

The use of expansion cards lowers the cost of the set top terminal **220** itself, while also increasing its potential functionality. Thus, an expansion card may include enhanced functional capabilities described as part of the upgrade module discussion above and be designed to accommodate any hardware upgrade compatible with the set top terminal **220**.

3. Remote Control and Subscriber Access of Set Top Terminal

The subscriber can access programs televised by the system through the set top terminal **220** using a remote control **900**. FIG. **13a** shows a two-section remote control **900** that accommodates such access. To reduce costs and make the set top terminal **220** as user friendly as possible, a standard television remote control **350**, such as a Jerrold RC **650** remote control or the like, may be augmented by adding a new section **352** that provides the additional digital menu access and ordering functions. FIG. **13a** depicts the addition of menu access and cursor movement control to the remote control **900**.

The remote control **900** has an ordering button **354** and four-way cursor movement **356** that includes a "go" button **358** and menu access buttons **360**. The preferred remote control **900** operates using infrared (IR) signals, with the signals being received by the Infrared (IR) sensor **630** on the front of the set top terminal **220**.

In the simplest embodiment, the remote **900**, may be built with only cursor movement and a go button. In more sophisticated embodiments, the remote control **900** may be provided with buttons that are programmable to perform specific functions for a series of entries. An intelligent or smart remote control **900** would increase both the cost and capability of the set top terminal **220** system. Using the augmented remote control **900** depicted in FIG. **13a**, a subscriber can navigate the program menu system of the set top terminal **220**.

FIG. **13b** shows an alternative and preferred embodiment of the remote control **900** for use in the present invention. Standard television receiver remote control switches or buttons **362** may be used, including volume control, channel select, power and signal source buttons, as well as other menu buttons **364**, including cursor movement, cursor select, menu select, and pay television buttons arranged longitudinally on the remote control **900**, as opposed to the width-wise separation, as shown in FIG. **13a**. The color of the buttons or the surrounding background may differ between the standard television remote control buttons **362** and the menu buttons **264** to differentiate visually between these two groups of buttons.

The width and depth of the remote control unit **900** are considerably less than the length to allow the remote control unit **900** to fit easily within a user's palm. The remote control unit **900** preferably has its center of mass balanced substantially near the longitudinal middle. This balance allows a user's thumb to naturally be placed in substantially the

middle portion of the remote control unit **900**, when it is picked up by a user.

Since the center of mass of the remote control unit **900** is placed substantially near the longitudinal middle of the remote control unit **900** (thereby having a user's thumb naturally fall in this same center region), the standard remote buttons **362** and menu access switches or buttons **364** most frequently accessed and depressed by a user are placed in the central region of the remote control unit **900** within easy reach of the user's thumb. Channel and volume increment and decrement buttons **366** are placed near this center of mass and longitudinal center line. The channel buttons **366** are preferably beveled in opposing directions to allow a user to feel for and press a desired button without looking down at remote **900**. Similarly, the volume buttons **368** are preferably beveled in opposing directions for the same reason. Additionally, the channel buttons **366** could have a surface texture different from those of the volume buttons **368** to allow even easier differentiation.

Also placed in the longitudinal center, within easy reach of a user's thumb, are cursor movement buttons **370** and a "go" button **372**. The "go" button **372** selects an option corresponding to the placement of the cursor. As opposed to buttons, a joystick may be used with a selection on the stick, or a trackball, depressible for selecting a desired choice. The cursor buttons **370** are placed ninety degrees apart, with the "go" button **372** placed within the center of the cursor movement buttons **370**, as shown in FIG. **13b**. The cursor movement buttons **370** are preferably beveled inwardly toward the "go" button **372** and the "go" button **372** is recessed below the level of the cursor movement buttons **370** so that it is not accidentally pressed while depressing the cursor movement buttons **370**. In addition to the beveling on the cursor movement buttons **370**, these buttons may also have a surface texture to allow a user to feel for and select the appropriate button without looking down at the remote **900** and directional arrows could be raised or recessed on the surface of the cursor movement buttons **373** for this same purpose.

Menu select buttons **374** are placed near buttons **370** as shown in FIG. **13b**. Menu select buttons **374** are preferably the largest buttons on the remote control unit **900**. Menu select buttons **374** preferably have icons or other graphics imprinted on their top surface or adjacent to corresponding buttons. For example, a button for the sports major menu may contain a baseball icon. The icons represent the programming available on the particular major menu selected by the menu select buttons **374**. The icons may also be raised above the level of the menu select buttons to provide a textured surface. This textured surface would allow a user to select an appropriate menu button **374** by feel, without looking at the remote control unit **900**. The icons would require substantial differences in texture, while still providing a meaningful graphic related to the associated menu.

As shown in FIG. **13b**, labels and icons are provided for the following major menus: movies, sports, children's programming, documentary/news, entertainment, magazines, programming guide, HDTV (high definition television), interactive TV, music, and an additional button **376** for further programming. Menu select buttons **374** may also be labeled A through J for the above programs, with the last button for all additional major menus labeled K-Z.

Although the remote control unit **900** is described with a variety of channel selection buttons, nearly all buttons from a standard remote control (section **362** buttons) could be eliminated. The present invention would allow a subscriber to use a remote control unit **900** containing only menu select

buttons **374** and/or cursor movement and select buttons, **370**, **374**, respectively.

As used herein, "button" is contemplated to include all manner of switches or touch sensitive circuitry to activate a particular function in the remote control unit **900**. Additionally, although the remote control unit **900** communicates with the set top box by means of infrared transmission, other forms of communication are contemplated, including ultra-sound, radio frequency and other electromagnetic frequency communication.

4. Advanced Features and Functional Capabilities

a. Overview

In the preferred embodiment, the set top terminal **220** will include features that are now being adopted in the industry, including parental controls and locks, electronic diagnostics and error detection, muting, on-screen volume control, sleep timer, recall of last selection, etc. Each of these features has a corresponding menu (or overlay menu) that allows on-screen customizing and activation of the feature.

The preferred set top terminal **220** also supports a number of advanced features and functional capabilities. This set top terminal **220** provides subscribers with a picture-on-picture capability without requiring a special television to support the capability. The set top terminal **220** also supports a program catalogue Service, which provides subscribers with information on all programming available at its particular subscriber location. The set top terminal **220** further includes the capability of querying viewers to establish, among other things, favorite channel lists, personal profile data and mood information. The set top terminal **220** allows the subscriber to view promotional menus on future programming events.

The set top terminal **220** supports additional capabilities using its hardware upgrades that allow subscribers to use other interactive services, for example, to engage in on-line question and answer sessions, to order and confirm airline tickets, and to access a variety of other data services. The set top terminal **220** makes use of a digital tuner as a hardware upgrade to provide subscribers with a digital audio capability.

The preferred set top terminal **220** may be used to control video tape machines, thereby simplifying the recording of programs. The set top terminal **220** can, in conjunction with the program delivery system, easily support high definition television (HDTV). For subscribers living in remote locations, the set top terminal **220** accommodates backyard satellite systems.

In addition to a the features that the set top terminal **220** supports with its current internal programming and upgradeability, additional features may be added or existing features increased through remote reprogramming of the set top terminal **220**. Utilizing the resident operating system on the read only memory (ROM), the cable headend **208** is able to reprogram the random access memory (RAM) of the set top terminal **220**. With this capability, the cable headend **208** can remotely upgrade software on the set top terminals **220**.

Reprogramming will occur by using the program control information signal, with the appropriate signals sent over this signal. In an alternative embodiment, one channel is dedicated for the special programming needs. When reprogramming is to occur, the cable head end will send an interruption sequence on the program control information channel that informs the set top terminal **220** that reprogramming information is to follow.

b. Picture-On-Picture Capability

Although the preferred embodiment of the present invention decompresses one channel at a time for the viewer, users who desire a picture-on-picture capability can be provided

with a set top terminal **220** have upgraded hardware components that allow two channels to be tuned and decompressed at any given time. Once two signals are available, the picture-on-picture capability can be made fully available in the set top terminal **220**, without requiring a special television.

FIG. **14** diagrams one embodiment for implementing the picture-on-picture capability. Such implementation necessarily requires the use of two tuners **603**, **603'** and two decompressors **618**, **618'** so that two separate video programs may be displayed simultaneously on the subscriber's television screen. As shown in the figure, the CATV input signal is received by the set top terminal **220** and input into two separate tuners. These tuners will each tune to a separate television program, both of which will be simultaneously displayed on the subscriber's television. The two television programs are extracted from the CATV input signal by the two parallel signals paths depicted in FIG. **14**.

Each signal path is substantially identical (therefore the components thereof are commonly numbered, with callout numbers of the components of one path carrying the prime indicator) and thus, only one path will be described. Each signal path shown includes a tuner **603**, a demodulator **606**, a demultiplexor **609**, a decryptor **600** and various decompression devices. As the respective signals pass through these devices, the microprocessor **602** coordinates the signal processing to produce a decrypted program signal. The decrypted program signal is further partitioned between audio, on the one hand, and video, graphics and text on the other. The audio signals extracted are passed to an audio decompressor **612**, which further processes the audio for output to the subscriber's television.

The embodiment diagramed in FIG. **14** shows only single audio channels for each video channel tuned by the individual tuners. As described above, the number of audio channels will typically include four audio signals corresponding to a single video channel. At least two of these audio signals may be used for stereo television play. Although the subscriber can view two separate video pictures simultaneously through the picture-on-picture capability, the subscriber's television can only accommodate a single audio signal at a time (or two audio signals for stereo audio reception). Thus, the set top terminal hardware shown in FIG. **14** must also include a switch (not shown), which accommodates the simple switching between each audio signal or signals that correspond to one video picture or another. Such an audio switch, which is a component well known in the art, allows the subscriber to listen to the audio of one picture or the other. The video, graphics and text portion of the program signal are routed through another demultiplexor **314**, which, in turn, separates all video, graphics and text of the signals. These signal parts are stored in a memory device **620** within the set top terminal **220**. This memory device may be a ROM, RAM, EPROM, or EEPROM.

The microprocessor **602** initiates and coordinates further decompression of the video, graphics and text for each of the program signals. Once these signal parts are decompressed within the set top terminal **220**, these components are passed to a video combiner **316**. The video combiner correlates and combines the video, graphics and text of the two program signals. The video combiner outputs these two signals for display on the subscriber's television. These signals may also pass through an NTSC encoder **625** to produce analog NTSC video waveforms, which may likewise be displayed on the subscriber's television. Such display necessarily requires that each signal pass through an modulator **605** in

order to be input into a television. In this way, two separate RF video outputs are produced. Each video signal produced by the RF modulators has its own corresponding audio outputs produced by each audio decompressor.

Each video signal (and its corresponding audio signal) produced by the two tuner configuration can be simultaneously displayed on the subscriber's television, which has a picture-on-picture capability, or, alternatively, the set top terminal **220** itself can create the picture-on-picture image for display. Such display involves the scaling and repositioning of one of the video (and audio) signals so that both pictures produced can be viewed simultaneously. In so doing, the subscriber's television can display one of the pictures as a full screen display, with the other picture being displayed as a scaled and repositioned display overlaid on the full screen display. To implement such a technique, the set top terminal **220** must include the hardware components necessary to produce a picture-on-picture capability, including hardware capable of scaling, repositioning and overlaying images. Such an advanced set top terminal **220** allows the subscriber to make use of a picture-on-picture capability even though the subscriber's television cannot alone produce such a result.

c. Program Catalogue Service

Referring to FIG. **15** and to FIG. **8**, in the preferred embodiment of the present invention, program catalogue menu **1100** listing programs available on network schedules, will be available as a major menu of the type shown as **1020**. In the preferred embodiment, the major program catalogue menu **1100** would offer submenus, such as network schedules for the next seven days, today's network schedules for the next six hours, and TV program catalogue picks for the next seven days.

In order for the set top terminal **220** to provide a program catalogue service, the set top terminal **220** must receive information on all programming available at its particular subscriber location. This information will be sent to each set top terminal **220** as part of the program control information signal or STICIS. The program control information signal would include, among other things, all programming scheduled for the next 7 days. This programming information would, for example, include the name of each program, the type of program, the program start time, the length of the program, the date the program will be shown, a brief description of the program and whether or not the program is closed-captioned, among other information.

All programming information sent to the set top terminal **220** for use with the program catalogue service will be stored in the set top terminals internal memory. Upon selection of the program catalogue service by the subscriber, the microprocessor accesses the memory device during its menu generation and creation process. In this way, the programming information will be combined with the program catalogue menu or submenu template to produce the Program catalogue service. The program catalogue service may involve the use of more than one menu, especially where the network scheduling information covers time frames longer than a few days.

If the particular set top terminal **220** has been subscribed to the program catalogue service, the subscriber may proceed to a submenu showing schedules of programs. If the subscriber chooses the network schedule submenu **1102**, he is offered a list of network schedules to choose from. If a subscriber were to choose, for instance, HBO, an HBO-specific submenu (not shown) would appear and allow a subscriber to choose a date of interest to see what programs are available on that particular date.

d. Querying Viewer

To support a variety of services, the set top terminal **220** is capable of querying the viewer and recording viewer responses. For example, in order for the set top terminal **220** to establish a favorite channel list as shown at **1100** in FIG. **16a** depicting the broadcast TV menu **1112**, menus querying the subscriber and allowing the subscriber to input his selection of eight favorite channels is displayed.

After querying the subscriber for a list of popular shows the terminal displays a submenu allowing the subscriber to choose one of the subscriber's favorite or popular shows for viewing. Although various embodiments of menus are possible, the goals of each are the same—to eliminate or augment printed guides to television programs. In an alternative embodiment, a program viewing suggestion feature is available as an additional feature. This feature gives the indecisive or lazy viewer suggestions as to which programs the viewer should watch. The set top terminal **220** uses a matching algorithm to accomplish this program suggestion feature. This program suggestion feature is described in detail in co-pending patent application Ser. No. 08/160,281, entitled, REPROGRAMMABLE TERMINAL FOR SUGGESTING PROGRAMS OFFERED ON A TELEVISION PROGRAM DELIVERY SYSTEM, incorporated herein by reference.

In order for the set top terminal **220** to make decisions on which programs the subscriber should watch, the terminal must create a personal profile for the particular viewer. From the data in the particular viewer's personal profile and the television program information available in the program control information signal, the set top terminal **220** is able to select a group of programs which the particular viewer is most likely to watch.

In order for this feature to operate, a personal profile for each viewer can be gathered by the set top terminal **220** and stored in a memory file. The personal profile consists of demographic information that may be gathered in a number of ways. The set top terminal **220** builds the personal profile for each viewer and stores the information in a memory file by viewer name. To build a personal profile in the preferred system, the viewer answers a series of questions presented on a series of menu screens. These personal profile screens request the viewer to input information such as name, sex, age, place of birth, place of lower school education, employment type, level of education, amount of television program viewing per week, and the number of shows in particular categories that the viewer watches in a given week such as, sports, movies, documentaries, sitcoms, etc. Any demographic information which will assist the set top terminal **220** in targeting advertisements to the viewer or suggesting programs may be used.

Once a personal profile has been created (in a particular set top terminal **220**), it can be indefinitely stored in non-volatile memory. A selection at the home menu screen **1010** (FIG. **8**) activates the program selection feature. Following activation of the feature, the set top terminal **220** will present the viewer with a series of brief questions to determine the viewer's mood at that particular time, as shown in FIG. **16b**. For example, the first mood question screen **1114** may ask the viewer to select whether the viewer desires a short (30 minute), medium (30–60 minute), or long (60 plus minute) program selection. The second mood question screen **1116** requests the viewer to select between a serious program, a thoughtful program, or a light program, as shown in FIG. **16c**. And the third mood question screen **1118** requests whether the user desires a passive program or an active program, as shown in FIG. **16d**. The viewer makes a

selection in each question menu, utilizing the cursor movement keys and "go" button on the remote control unit **900**.

After the viewer has responded to the mood question menus which determine his mood, the set top terminal **220** uses the personal profile information and mood information to find the best programming matches for the viewer. The set top terminal **220** displays an offering of several suggested programs to the viewer. With its program selection feature, the set top terminal **220** can intelligently assist the specific viewer in selecting a television program.

The personal profile information may also be used in targeting advertisements. In the preferred embodiment, the network controller **214** can target specific advertisements to individual cable distribution network nodes or, alternatively, to individual subscribers. In order to accomplish the advertisement targeting capability, the network controller **214** transmits packages of advertisements to the cable distribution network nodes or subscribers for eventual display on the set top terminal **220**. When the video that the subscriber is watching nears a break for a commercial, a specific advertisement or set of advertisements is specifically targeted to a particular set top terminal **220** based on the personal profile information described above. Although the network controller **214** is the component in the program delivery system which provides this targeting capability, the set top terminal **220** accommodates transparent channel switches to display the targeted advertisement. In this way, although the subscriber thinks that the set top terminal **220** is tuned to a specific channel, an advertisement from another channel is displayed on the subscriber's television.

The hardware required to accommodate such transparent channel switching capabilities are shown in FIGS. **17a** and **17b**. FIG. **17a** shows the set top terminal hardware components which accommodate channel switching within a single 6 MHz channel bandwidth. These components include a tuner **603**, a demodulator **606**, a demultiplexer **609**, a multiplexer **400**, a decompressor **622**, a microprocessor **602**, and local memory **M**. The tuner **603** operates by tuning to a specific 6 MHz bandwidth which includes the displayed video and a number of channels carrying advertisements. The demodulator **606** processes these signals and sends them to the demultiplexer **609**, which converts the received signal into separate program and advertisement signals. During this processing, the microprocessor **602** coordinates the demultiplexing of the programming signals. Once the video signal pauses for a commercial break, the microprocessor **602** instructs the multiplexer **400** to select the advertisement or advertisements for decompression and subsequent display on the subscriber's television. This hardware configuration allows the set top terminal **220** to switch between channels within the 6 MHz bandwidth and display various advertisements for viewing, regardless of the video currently being watched by the subscriber.

Where a targeted advertisement falls outside the tuned 6 MHz bandwidth containing the video that the subscriber is currently watching, the hardware configuration shown in FIG. **17b** is used. In this configuration, the microprocessor **602** instructs the tuner **603** to retune to another 6 MHz channel bandwidth, as represented by bi-directional arrow **A**.

Working together, the microprocessor **602** and tuner **603** allow targeted advertisements, which have been transmitted in another 6 MHz bandwidth, to be tuned with minimal acquisition time and delay. In particular, this configuration allows the set top terminal **220** to tune outside a given 6 MHz bandwidth (to another 6 MHz bandwidth) in order to select a targeted advertisement for display. This alternative

embodiment may require the use of a full screen mask in order to minimize any annoying screen rolling during the tuning process. The masking is intended to cover any glitches which would otherwise be displayed during the acquisition time (e.g., 0.5 seconds) for retuning to another 6 MHz channel bandwidth.

Where the acquisition time or delay becomes unreasonable, an alternative embodiment (not depicted) can include the use of two tuners similar to the configuration used above for the picture-on-picture capability. This alternative configuration using two tuners trades an increased cost for lower acquisition times. Those skilled in the art will recognize a number of other configurations of set top terminal hardware that will accommodate a transparent channel switching feature. A more detailed description of target advertising and channel switching is provided in patent application Ser. No. 08/160,280, entitled, NETWORK CONTROLLER FOR CABLE TELEVISION DELIVERY SYSTEM, incorporated herein by reference.

e. Promotional Menus

FIG. **18** depicts the use of a promotional menu **1120** used to sell subscriptions to services in the system **200**. This promotional menu is tailored to Level B interactive services which include a variety of on-line type services such as Prodigy, Yellow Pages, Airline Reservations, etc. A similar menu is used for Level A interactive services that offers subscribers additional information about programs such as quizzes, geographical facts, etc. Such information may be received by the set top terminal **220** in several data formats, including in the vertical blanking interval (VBI) and in the program control information signal.

Other promotion menus similar to menu **1120** may be used for the Level C interactive services. The Level C interactive services utilize local storage such as CD technology (e.g., **122**) to offer an enormous range of multi-media experiences. The Level C Interactive services require a hardware upgrade as described earlier. Specially adopted CD-I and CD-ROM **122** units are used for this service.

Typically, promotional menus may be generated when a subscriber selects a nonexistent channel, creating a virtual channel. Such virtual channels do not require any additional bandwidth since these channels do not carry any of the data required to create a promotional menu. Instead, when the subscriber selects a channel that does not exist (e.g., Channel **166**), a virtual channel is created using data sent to the set top terminal in a number of ways. For example, the data may be sent in the vertical blanking interval (VBI) of another channel, out-of-band, or with the menu information sent from the headend **208** in the set top terminal control information stream (STTCIS). The data will be used to create graphics stored locally at the set top terminal **220** as an NTSC video signal which may be displayed on the subscriber's television. In this way, a promotional menu may be drawn and a virtual channel is created. This capability simply provides the set top terminal **220** with the ability to display a promotional menu or graphics display whenever a nonexistent channel is selected by the subscriber.

f. Other Interactive Services

FIGS. **19a** and **19b** show menus (**1130** and **1132**, respectively) that are available using the interactive Level A services. Referring to FIG. **19a**, when interactive Levels A services are available for a television program, the system will display an interactive logo **1134** consisting of the letter "I" and two arrows with semicircular tails. In the preferred embodiment, the set top terminal **220** will place the interactive logo on the television screen as an overlay menu. In the preferred embodiment, the set top terminal **220** will

detect that there is data or information available about a television program which can be displayed to a subscriber using the interactive service. When the set top terminal 220 senses that there is interactive information available, it will generate the interactive logo overlay menu 1134 and place it on the television screen. For example, the set top terminal 220 will detect that information on a television program is being sent in the vertical blanking interval (VBI) and generate an interactive logo overlay menu 1134 which will appear on the subscriber's television screen for approximately fifteen seconds during each ten minute interval of programming. Similarly, the set top terminal 220 can sense that the programming has closed caption information available and place a closed caption logo on the screen.

Referring to FIG. 19b, when the subscriber sees the interactive logo 1134 on the television screen, the subscriber is made aware of the fact that interactive services are available in conjunction with his television program. If the subscriber presses the interactive remote control button, another overlay menu 1133 will be generated by the set top terminal 220 and placed on the screen. This overlay menu 1133 is shown in FIG. 19b being overlaid on an interactive television program. From this menu 1133, the subscriber may select a variety of different types of textual interactivity with the current television program, as at 1134, including quizzes, fast facts, more info, where in the world, products, etc. At any time during the interactive submenus, the user may return to the television program without interactive features.

Another submenu 1136 gives additional information related to the television program to the viewer in textual form in the lower half of the screen. In FIG. 19b, the submenu 1136 shows the available interactive options for the subcategory "quiz." In this interactive subcategory, the user is presented with questions and a series of possible answers. If the subscriber desires, the subscriber selects one of the answers to the quiz question. After the selection, the set top terminal 220 sequences to another menu. The set top terminal 220 sequences to the interactive quiz answers submenu which informs the subscriber whether the correct answer was or was not chosen. Subsequently, another submenu would show correctly or incorrectly answered quiz question.

FIG. 20a is an example of a submenu for Level B interactive services. From this menu screen 1141, any of a number of on-line data services could be accessed. One service, the airline reservations selection 1142, has been chosen by the subscriber on this menu.

In selecting airline reservations, the subscriber encounters a sequence of menus as for any on-line data service. Referring to FIG. 20b, the subscriber is typically shown a submenu, such as submenu 1144, for the data service offering various options. In each of these submenus related to a data service, the subscriber is able to exit, returning to the home menu 1010 or regular cable TV.

FIG. 20b, the airline information and reservation submenu 1144, allows a subscriber to view six available flights. A subscriber may select one of the flights to check on its availability. Another similar submenu allows a subscriber to enter the month, day and year for the availability date desired. In this submenu, the subscriber is offered the option of correcting any errors in the entered information.

FIG. 20c is another airline submenu 1150 that allows a subscriber to view remaining seats available on a flight, enabling the selection of a seat assignment. This interactive submenu 1150 is an example of how information may be graphically shown to a subscriber using a portion of the

menu and different coloring schemes. In this interactive menu, the lower half of the screen 1152 shows the passenger compartment of an airplane with all the seat locations graphically represented by square blocks. By coloring the available seat locations in blue and the unavailable seat locations in a different color, the menu can present a great deal of information in a limited amount of space. This graphic presentation of information for the interactive on-line data services is an important method of visually displaying large amounts of information to the subscriber.

Referring to FIG. 20d, another submenu 1156 allows the subscriber to choose a one-way or round-trip ticket, to confirm reservations and to charge an airline ticket by credit card, choosing the appropriate strip menu on the lower part of the screen. In this particular menu 1156, the subscriber is charging a round-trip plane ticket on a credit card. The subscriber simply needs to enter the credit card number, expiration date, and credit card type to charge an airline ticket. Other submenus may process the subscriber's credit card charge for the airline ticket, confirm the subscriber's airline ticket purchase, and pass this information to the location where the ticket is printed.

Using the methods and hardware described, a variety of interactive services are possible. Those skilled in the art will recognize that such interactive services may be accommodated by the preferred set top terminal 220.

g. Caller ID

Using the capability of the set top terminal and a connected modem, the set top terminal is able to perform the function of caller ID. The caller ID function of the set top terminal assists the viewer in a manner similar to the caller ID function provided by telephone companies. However, the set top terminal is able to use the television as its display means to communicate to the viewer information about incoming telephone calls. Also, the strong local processing capability of the set top terminal allows the caller ID function to be much more user friendly and convenient.

If the set top terminal senses that a viewer is using the system and watching television, then the caller ID feature would automatically be activated. When the caller ID function is active, the set top terminal software will monitor incoming telephone calls to the viewer through the modem. After the set top terminal senses that the phone is ringing, signals are received on the tip and ring lines of the telephone, the system will immediately look for incoming telephone data identifying the telephone number from which the telephone call was initiated.

Upon receiving the telephone number from which the call was initiated, the preferred embodiment of the caller ID compares the telephone number with a list of telephone numbers stored in memory. The list of telephone numbers stored in memory is cross referenced to a list of names, other textual data or graphics. When the set top terminal finds a match between the telephone number and a number stored in memory, the corresponding text or graphics are displayed on the television screen. For example, "GRANDMA" and a "smiley face" graphic can be flashed across the television screen using an overlay menu.

In this manner the viewer may see the name (and identifying icon graphics) of the person placing the call and can decide whether to activate an automatic telephone message recording system or answer the telephone call. After generating an overlay menu, the set top terminal software awaits an IR command signifying a viewer response. With the simple depression of a button on the remote control, the viewer can instruct the set top terminal to send an activation signal to the automatic telephone message system (through

a set top terminal port). Thus, the viewer can continue to watch a program and know the identity of a caller without taking his or her eyes off the television. If a dumb telephone message system is used, the viewer can simply allow the telephone to ring the requisite number of rings until the telephone answering machine normally activates and answers the call.

In an alternative embodiment, having no stored telephone numbers, the set top terminal may just flash the incoming telephone number on the screen using an overlay menu. In a more sophisticated embodiment, a microphone is provided in the set top terminal or remote control unit. Using the television's speakers, a remote control, and a microphone, the viewer is able to answer the telephone using the keys of the remote control without taking his or her eyes off the television screen.

h. Digital Audio Capability

Referring to FIG. 21, the digital audio feature of the invention allows a subscriber to listen to CD quality audio selections through the subscriber's stereo (not shown). This can be accomplished by running cables directly from the set top terminal 220 (which may include a Level D hardware upgrade) to the subscriber's amplifier/stereo system. Alternatively, the subscriber may listen to audio selections through the subscriber's television system.

In the preferred embodiment, the digital audio feature uses a Level D hardware upgrade as a digital radio tuner. This Level D hardware upgrade enables a subscriber to use the program delivery system's digital audio signaling capability. Digital audio transmissions require much less bandwidth than that used for the transmission of a digital video signals. Thus, hundreds of digital audio programs are delivered to each set top terminal 220 in limited segments of bandwidth.

Where digital audio programs are delivered to the set top terminal 220, the Level D upgrade (shown in FIG. 13b) provides the subscriber with the means to select a given digital audio program for listening. The Level D hardware upgrade makes use of a tuner 603 that is separate from the tuner 603 used by the set top terminal 220 for video display. The digital audio signal is received at the set top terminal 220 over the CATV transmission media. The set top terminal 220, in turn, routes the digital audio signal to the components of the Level D hardware upgrade. These components may include: a tuner 603, demodulator 606, demultiplexer 609, decryptor, decompressor 622, remote control interface and microprocessor 602.

The Level D hardware upgrade will use its tuner 603 to tune to the specific digital audio program selected by the subscriber and subsequently demodulate, demultiplex and decrypt the digital audio signal. Upon completion of this processing, the digital audio signal will be decompressed to produce a processed digital audio signal ready to be output to the subscriber's stereo or directly to speakers.

The Level D hardware upgrade includes ports for the digital audio signal output, which provide the necessary connections for transmission of the signal from the Level D hardware upgrade to the subscriber's stereo. In addition, the Level D hardware upgrade include a small LED display that can show the channel number of the program selected, date and time, among other display fields.

The Level D hardware upgrade can be physically located in a different room from that of the television and set top terminal 220. Thus, the Level D hardware upgrade will have its own remote control device (not shown), albeit with less available options and keys than the set top terminal's remote control 900 described above. This Level D hardware

upgrade remote control is more limited than the set top terminal's remote control 900 since the Level D remote control will be used exclusively for digital audio program selection. This limited remote control, nevertheless, includes a small LED or LCD display that is used to display the channel number of the digital audio program selected. Alternatively, the set top terminal's remote control may be programmed for use with the Level D hardware upgrade so that an additional remote control is not required to use the digital audio feature.

Using either remote control embodiment, the subscriber accesses the Level D hardware upgrade to select a digital audio program. The remote control sends an IR command signal to the Level D hardware upgrade, instructing the unit's microprocessor 602 to initiate the selection of a given program. The desired program is processed (i.e., tuned, demultiplexed, decrypted and decompressed) as described above and transmitted to the subscriber's stereo for listening.

The selection of a digital audio program does not necessarily require interaction with the subscriber's television. Instead, all communications required to select a digital audio program may occur between a remote control and the Level D hardware upgrade. As a result, the subscriber's television need not be turned on for the digital audio capability to operate.

Alternatively, the Level D hardware upgrade can be co-located with the set top terminal 220 and the subscriber can select a digital audio program through a menu displayed on the subscriber's television. In this embodiment, the subscriber would use the set top terminal remote control to access a digital audio program selection menu.

In an alternative embodiment the set top terminal 220 includes all the features of the Level D upgrade and, therefore, no upgrade is necessary. Those skilled in the art will recognize other alternatives that allow digital audio reception.

FIG. 21 is a major menu 1160 displaying the digital audio program choices which are available for subscribers who have paid the monthly fee. In a chart format 1162, the major menu shows the top five, ten, and forty songs available in six different categories of music. Below the chart, the system is able to provide a text message 1164 describing the particulars of the audio program selected. Using the same logos and menu format, the system can provide a text description enticing the subscriber to pay the monthly fee and join the service. For example, one menu may allow the user to test the system with a free demonstration. Another menu allows the subscriber to request additional promotional information about the system. Such menus may be used throughout the menu system. From any of the menu screens for the digital audio feature, the subscriber may return to regular cable TV with the press of a single button.

i. VCR Control

Referring to FIG. 22, the advanced system of the set top terminal 220 is used to control video tape machines and simplify recording programs using a Guide Record feature. The set top terminal 220 has a separate output 650 for a VCR. Control signals are transmitted through the VCR output of the set top terminal 220 and input to the VCR to allow the VCR to be automatically controlled by the set top terminal 220. Using the set top terminal 220, certain programs are selected by a subscriber from menus, and the VCR will be automatically activated to record the selected program.

In order to accommodate the VCR control feature, the set top terminal 220 sends instructions or control signals to the

VCR. Such control signals are initiated by the set top terminal's microprocessor **602** and passed to the VCR either using a separate connection or as part of the video signals processed for display on the subscriber's television. These control signals are sent directly from the advanced set top terminal **220** to the VCR, instructing the VCR when to begin and end taping of a particular program.

The microprocessor **602** coordinates the dissemination of control signals sent to the VCR, storing the content of such signals in local memory. Upon nearing the time for the program to be displayed, the microprocessor **602** activates the menu generation software to display a notification menu or screen, noting the subscriber that the program is nearing the time for display. This reminder will also request the subscriber to check whether a tape has been inserted into the VCR itself.

The subscriber can initiate the VCR control feature by accessing a VCR control submenu, which requests whether the subscriber wishes to record a program selected for future viewing. In this way the subscriber interactively enters such information on the menu screen or display using any of the hardware described above that accommodates subscriber interactive response capabilities.

In the preferred embodiment, the subscriber will use a movie library in conjunction with his VCR or other video taping machinery. The movie library is a menu selectable list of available movies. In that way, a subscriber may tape movies which are shown at inconvenient start times for later viewing. By enabling the proper features of the set top terminal **220**, a subscriber can have the terminal activate the television and the VCR and perform all the functions necessary to tape a movie.

After the VCR control feature is initiated, a menu screen confirms the movie selection, start date and start time and informs the subscriber that the VCR will be automatically turned on. During this submenu, the user may return to the movie library major menu, or regular TV or cancel the movie library order by pressing the escape button. This menu shows that the subscriber has chosen to return to regular TV. The subscriber's VCR or other video taping equipment must be connected to the set top terminal **220** for the automatic taping feature to operate.

Following a program choice, a program description submenu is placed on the television screen. In addition, from this program description submenu, the viewer may choose to record the selected program on his VCR using the guide record feature. If the guide record feature is chosen, the guide record submenu **1170** shown in FIG. **22** provides the subscriber with further instructions. In order for the set top terminal **220** to perform the guide record functions and operate the VCR, control signals are sent from the set top terminal **220** to the VCR via the video connection **650** or through a separate connection between the set top terminal **220** and the VCR. The VCR is capable of interpreting these control signals from the set top terminal **220** and performing the desired function (such as, activating the record feature). In the preferred embodiment, the VCR control signals are sent with the video signal and output from the output **650**, as described above. Alternatively, a separate connection between the set top terminal **220** and VCR may be used.

j. HDTV Capability

The set top terminal **220** and program delivery system of the preferred embodiment can easily support high definition television (HDTV). The combination of digital video, compression and no restricted bandwidth limitation per channel makes the preferred system ideal for HDTV. The greater information flow of HDTV causes no problems for the

system. The menu selection system of the preferred embodiment is a user friendly manner of presenting HDTV programming to the subscriber.

FIG. **23** shows the integration of HDTV services into the menu-driven program delivery system. If the subscriber selects the major menu for HDTV **1032**, the subscriber will receive either a description of the service with a suggestion to order the system, or a text note that the subscription is current and a listing of the currently available program selections in HDTV. If the subscriber has not paid to join the particular service, HDTV, the subscriber may be allowed to join one of the programs in progress for a limited time as a demo to entice the subscriber to order.

If a subscriber has paid the HDTV fees, the subscriber proceeds as in any other major menu screen. This particular major menu shows an example of how a follow-on or second screen may exist for the same menu. In this particular case, a second screen exists for the major menu HDTV **1032**. The subscriber may access the second screen by selecting the last menu display block **1172** "Other HDTV Selections" in the lower part of the screen. Following this selection, the subscriber will be given a second screen of program selections. In this manner, any menu can have multiple screens with many program choices. This type of screen pagination on one menu allows the operations center **202** packager to avoid categorizing program selections within that same menu. In an alternative embodiment, the options available to the subscriber may be scrolled on one menu screen with the text within the menu display blocks changing as the subscriber scrolls up or scrolls down. Many variations of this HDTV example can be used with the described system.

k. Backyard System

In an alternative configuration, in areas without cable services where subscribers use backyard satellite systems (TV RO) to receive packaged television services, the set top terminal **220** will include the appropriate hardware to allow connection to the satellite **206** reception equipment through port **656**. In this configuration, the menu system within the set top terminal **220** will be programmed directly from the operations center **202**. Additionally, an upstream communication mechanism must be in place at the subscriber's home (i.e. modem) to communicate information to the operations center.

The hardware components that allow the set top terminal **220** to operate in a backyard system typically will not be included within the set top terminal shell itself. Instead, any such components accommodating the set top terminal's interoperability with a backyard program delivery system will typically reside outside the subscriber's home. As a result, the set top terminal **220** will operate as described above, notwithstanding any change in program delivery transmission media.

The terms and descriptions used herein are set forth by way of illustration only and are not meant as limitations. Those skilled in the art will recognize that numerous variations are possible within the spirit and scope of the invention as defined in the following claims.

What is claimed is:

1. An upgrade module for enhancing the functionality of a decompression box for use in a cable television program delivery system, the enhanced functionality using a control information stream that provides the decompression box with menu generation capability, the decompression box initially having the capability to produce decompressed video, the upgrade module comprising:

an interface means for providing an electronic connection to the decompression box so that the control information stream may be received from the decompression box;

a means, connected to the interface means, for demultiplexing the control information stream into graphics and text;

a means, connected to the demultiplexing means, for combining the text and graphics to produce a menu generation signal; and

a means, connected to the combining means and interface means, for transferring the menu generation signal to the interface means for output to the decompression box, whereby the menu generation signal is processed for display.

2. The upgrade module of claim 1 further comprising a graphics decompressor, connected to the demultiplexing means, for decompressing the graphics to produce decompressed graphics that may be used to generate menus.

3. The upgrade module of claim 1 for further providing the decompression box with a program catalogue that provides the subscriber with program schedules and descriptions, the decompression box providing the upgrade module with video signals, wherein the interface means comprises a means for receiving the video signals from the decompression box and wherein the combining means comprises:

- a means for interpreting the text and graphics;
- a means, connected to the interpreting means, for integrating the interpreted text and the interpreted graphics to produce the menu generation signal, whereby the menu generation signal carries data required for display of the program catalogue; and
- a means for sending the menu generation signal to the transfer means, whereby the menu generation signal is output to the decompression box for display of the program catalogue.

4. The upgrade module of claim 1 for further enabling the decompression box to use promotional menus that provide the subscriber with promotional videos, text and graphics showing future events available for menu driven program selection, the decompression box providing the upgrade module with video signals, wherein the interface means comprises a means for receiving video signals from the decompression box, and wherein the combining means comprises:

- a means for interpreting the text and graphics;
- a means, connected to the interpreting means, for integrating the received video signals, the interpreted text and the interpreted graphics to produce the menu generation signal, whereby the menu generation signal carries data required for display of the promotional menus; and
- a means for sending the menu generation signal to the transfer means, whereby the menu generation signal is output to the decompression box for display of the promotional menus and the promotional videos, and text and graphics.

5. The upgrade module of claim 1, wherein the menu generation capability makes use of graphics and text stored locally within the upgrade module, and wherein the upgrade module further comprises a memory means for storing the graphics and text for use with the menu generation signal, so that the menus can be generated.

6. The upgrade module of claim 1, wherein the interface means comprises at least one cable connector adapted for use with an upgrade port on the decompression box.

7. The upgrade module of claim 1, wherein the decompression box has an expansion card slot, and wherein the interface means comprises at least one card connector for use with the expansion card slot.

8. The upgrade module of claim 1 for further providing the decompression box with a telephone caller identification message, the decompression box having a port adapted to receive telephone signals from a telephone line, wherein the upgrade module further comprises:

- a connection means for providing an electronic connection to the decompression box for receiving the telephone signals;
- a means, connected to the connection means, for processing the received telephone signals to produce text messages and graphics icons; and
- a means, connected to the processing means, for sending the text messages and graphics icons to the combining means to produce the menu generation signal, whereby the text messages and graphics icons are used to form the menu generation signal that is transferred to the decompression box for display of the caller identification message.

9. The upgrade module of claim 1 for further providing the decompression box with video cassette recorder control capability that uses recording menus presenting selection options to a subscriber and video cassette recorder control signals sent to the decompression box, the video cassette recorder control signals corresponding to the selection options chosen by the subscriber, the upgrade module further comprising:

- a means for generating the recording menus;
- a means for interpreting the selection options chosen by the subscriber and received from the decompression box through the interface means;
- a means for generating the video cassette recorder control signals based on the interpreted selection options chosen by the subscriber; and
- a means for transmitting the video cassette recorder control signals to the decompression box for instructing the video cassette recorder in recording of programs.

10. An upgradeable set top converter for use in a cable television program delivery system, the set top converter having video decompression capability and adapted to accept a menu generation card, the set top converter upgradeable for enhanced functionality that provides the set top converter with menu generation capability using a control information stream received from a remote location, the upgradeable set top converter comprising:

- a means for receiving the control information stream from the remote location; and
- an expansion card interface means, connected to the receiving means, for accepting the menu generation card, whereby the menu generation card is external to the set top converter and upgrades the set top converter for menu generation capability.

11. The upgradeable set top converter of claim 10 wherein the expansion card interface means comprises means for transferring the control information stream from the set top converter to the menu generation card, and wherein the menu generation card creates a menu generation signal using the control information stream.

12. An upgraded set top converter for use in a cable television program delivery system, the set top converter upgraded for enhanced functionality that provides the set top converter with menu generation capability using a control information stream received from a remote location, the upgraded set top converter comprising:

- an expansion card interface means for providing an electronic connection; and

45

a menu generation card, electronically connected to the expansion card interface means, comprising a means for processing the control information stream to produce a menu generation signal, whereby the menu generation signal is output through the expansion card interface means to be processed for display.

13. The upgraded set top converter of claim 12, wherein the menu generation card further comprises means for demultiplexing the control information stream into more than one signal component including graphics and text; and means for combining the the demultiplexed text and graphics to produce the menu generation signal.

14. The upgraded set top converter of claim 13 with the enhanced functionality further providing the set top converter with a program catalogue that provides the subscriber with program schedules and descriptions corresponding to video signals, wherein the interface means comprises a means for receiving the video signals, and wherein the combining means comprises:

a means for interpreting the demultiplexed text and graphics;

a means, connected to the interpreting means, for integrating the interpreted text and the interpreted graphics to produce the menu generation signal, whereby the menu generation signal carries data required for display of the program catalogue; and

whereby the menu generation signal is output through the expansion card interface means to the set top converter for display of the program catalogue.

15. The upgraded set top converter of claim 13 for further enabling the set top converter to use promotional menus that provide the subscriber with promotional video signals, text and graphics showing future events available for menu driven program selection, wherein the expansion card interface means comprises a means for receiving the promotional video signals, and wherein the combining means comprises:

a means for interpreting the demultiplexed text and graphics;

a means, connected to the interpreting means, for integrating promotional video signals, the interpreted text and the interpreted graphics to produce the menu generation signal, whereby the menu generation signal carries data required for display of the promotional menus; and

whereby the menu generation signal is output to the set top converter for display of one of the promotional menus.

16. The upgraded set top converter of claim 13, wherein the demultiplexed graphics are compressed and wherein the menu generation card further comprises means for decompressing the demultiplexed graphics.

17. The upgraded set top converter of claim 12 for further providing the set top converter with a telephone caller identification message, the set top converter having a port adapted to receive telephone signals from a telephone line, wherein the expansion card interface means further comprises:

a connection means for providing the electronic connection to the set top converter, whereby the telephone signals are received from the set top converter; and

wherein the menu generation card further comprises:

a means for processing the telephone signals to produce text messages and graphics icons; and

a means for sending the text messages and graphics icons to the combining means to produce the menu generation signal, whereby the text messages and

46

graphics icons are used to form the menu generation signal that is transferred to the set top converter for display of the caller identification message.

18. The upgraded set top converter of claim 12 for further providing the set top converter with video cassette recorder control capability that uses recording menus presenting selection options to a subscriber and video cassette recorder control signals sent to the set top converter, the video cassette recorder control signals corresponding to the selection options chosen by the subscriber, wherein the menu generation card further comprises:

a means for generating the recording menus;

a means for interpreting the selection options chosen by the subscriber and received from the set top converter through the expansion card interface means;

a means for generating the video cassette recorder control signals based on the interpreted selection options chosen by the subscriber; and

a means, connected to the generating means, for transmitting the video cassette recorder control signals to the set top converter for instructing the video cassette recorder in recording of programs.

19. An advanced set top terminal with digital decompression and menu generation capabilities for use with a television program delivery system having digitally compressed program signals and a control information stream carrying menu content information, each set top terminal stores menu content information used to generate menu displays, the advanced set top terminal comprising:

a means for storing the menu content information;

a means for receiving the digitally compressed program signals and the control information stream;

a first signal processing means, connected to the receiving means and storing means, for processing the control information stream to produce processed control information, whereby the processed control information is used to update the stored menu content information to produce updated menu content information;

a means, connected to the storing means, for generating the menu displays using the updated menu content information, whereby the menu displays produce subscriber options for selection of other menus and television programs;

a means, electronically connected to the generating means, for selecting the other menus and the television programs;

a means, electronically connected to the selecting means, for tuning to one of the digitally compressed television programs signals to produce a tuned television program signal; and

a second signal processing means, connected to the tuning means, for processing the tuned television program signal to produce a video signal and audio signal for television display and listening.

20. The advanced set top terminal of claim 19, wherein the second signal processing means comprises:

a means for demodulating the tuned television program signal to produce a demodulated program signal;

a means, connected to the demodulating means, for demultiplexing the demodulated program signal to produce video signal components and audio signal components;

a video decompressing means, connected to the demultiplexing means, for decompressing the video signal components to produce decompressed video signal components;

47

an audio decompressing means, connected to the demultiplexing means, for decompressing the audio signal components to produce decompressed audio signal components;

- a means, connected to the video decompressing means, for combining the decompressed video signal components with the stored menu content information for television display of the video signal; and
- a means, connected to the audio decompressing means, for producing the audio signal from the decompressed audio signal components.

21. The advanced set top terminal of claim 20 that has a picture-on-picture capability using multiple tuners, wherein the tuning means comprises more than one tuner so that the multiple tuners can produce multiple television program signals which will be overlaid over one another.

22. The advanced set top terminal of claim 19 having a program catalogue service that provides the subscriber with program schedules and descriptions, the program schedules and descriptions created from text and graphics, the text and graphics derived from the control information stream, wherein the advanced set top terminal further comprises:

- a means, connected to the storing means, for interpreting the text and graphics;
- a means for integrating the interpreted text and the interpreted graphics to produce a menu generation signal, whereby the menu generation signal carries data required for display of the program catalogue; and
- a means for outputting the menu generation signal for display.

23. The advanced set top terminal of claim 20 having a promotional menu display capability that provides subscribers with promotional videos, text and graphics showing future events available for menu driven program selection, wherein text and graphics are derived from the control information stream, and wherein the advanced set top terminal further comprises:

- a means, connected to the storing means, for interpreting the text and graphics;
- a means for integrating the interpreted text, the interpreted graphics and the decompressed video to produce a menu generation signal, whereby the menu generation signal carries data required for display of the promotional videos; and
- a means for outputting the menu generation signal for display.

24. The advanced set top terminal of claim 19 capable of operating with interactive services conducted from a cable headend or other remote location, the interactive services requiring entry of interactive subscriber inputs and use of interactive programming instructions, wherein the selection means comprises:

- a subscriber interface means for entry of the interactive subscriber inputs;
- a means for storing the interactive programming instructions;
- a means, connected to the storing means, for accessing the stored interactive programming instructions;
- a microprocessing means, connected to the accessing means for executing the stored interactive programming instructions to produce interactive signals; and
- an upstream data transmission means, connected to the microprocessor means, for transmitting the produced interactive signals to the cable headend.

25. The advanced set top terminal of claim 19 having a caller identification function capable of displaying a caller

48

identification message using a menu generation signal, wherein the advanced set top terminal further comprises:

- a means for receiving telephone signals;
- a means, connected to the receiving means, for processing the telephone signals to produce text messages and graphics icons using the menu content information;
- a means, connected to the processing means, for combining the text messages and graphics icons to produce the menu generation signal carrying the caller identification message for television display; and
- a means, connected to the combining means, for preparing the menu generation signal for television display.

26. The advanced set top terminal of claim 19 capable of processing high definition television signals, wherein the second signal processing means comprises:

- a means for interpreting the high definition television signals; and
- a means for preparing the interpreted high definition television signals for television display.

27. The advanced set top terminal of claim 19 capable of receiving the control information stream through a satellite system, the means for receiving the digitally compressed program signals and the control information stream is comprised of the satellite system, wherein the satellite system is electronically connected to the first signal processing means.

28. A method for enhancing the functionality of a decompression box for use in a television program delivery system, the enhanced functionality using a control information stream that provides the decompression box with menu generation capability, the decompression box initially having the capability to produce decompressed video, the method comprising the steps of:

- providing an electronic connection to the decompression box so that the control information stream containing graphics, text and menu generation information may be received from the decompression box;
- demultiplexing the received control information stream into graphics, text, and menu generation information;
- combining portions of the text and graphics information, to produce a menu generation signal, wherein the menu generation information is used in the combining step; and
- transferring the produced menu generation signal to the decompression box, whereby the transferred menu generation signal is processed for display.

29. A method for upgrading a set top converter for use in a television program delivery system, the set top converter having video decompression capability and an expansion card slot adapted to receive a menu generation card, the set top converter upgradeable for enhanced functionality that provides the set top converter with menu generation capability using a control information stream received from a remote location, the method comprising the steps of:

- providing an electronic connection to the set top converter for receiving the control information stream;
- demultiplexing the control information stream into graphics and text, whereby the control information stream is received from the set top converter;
- decompressing the graphics to produce decompressed graphics that may be used to generate menus; and
- connecting the menu generation card to the set top converter; and
- using the menu generation card to combine the text and decompressed graphics to produce a menu generation

49

signal, whereby the menu generation signal is output to the set top converter to be processed for display.

30. The method of claim 29, wherein a satellite system is used at a subscriber location, and wherein the step of providing an electronic connection to the set top converter further comprises the steps of:

receiving the control information stream from the remote location using the satellite system; and

providing the control information stream from the satellite system to the set top converter, wherein the satellite system is electronically connected to the set top converter.

31. A method for enhancing the functionality of a cable-ready television for use in a cable television program delivery system, the cable-ready television having an electronic interface that accommodates the enhanced functionality using a control information stream, the enhanced functionality providing the cable-ready television with menu generation capability, the method comprising the steps of:

receiving the control information stream from the cable-ready television through the electronic interface;

demultiplexing the control information stream into graphics, text and menu generation information that includes information on program packaging and menu content;

combining the graphics, text and menu generation information to produce a menu generation signal; and

transferring the menu generation signal to the cable-ready television through the electronic interface, whereby the menu generation signal is processed for display.

32. An apparatus for enhancing the functionality of a set top converter for use in a television program delivery system, wherein the apparatus uses a control information stream received from a remote location to provide the set top converter with menu generation capability, the set top converter having the capability to produce decompressed video, comprising:

an interface means for providing an electronic connection to the set top converter so that the control information stream may be received by the apparatus from the set top converter;

a means, connected to the interface means, for demultiplexing the control information stream into graphics and text; and

a means, connected to the demultiplexing means, for combining the text and graphics to produce a menu generation signal,

50

whereby the menu generation signal is processed by the set top converter for display.

33. The apparatus of claim 32, capable of receiving the control information stream through a satellite system, the apparatus further comprising:

a satellite system, wherein the satellite system receives the control information stream from the remote location and sends the control information stream to the set top converter, and wherein the satellite system is electronically connected to the set top converter.

34. An upgrade module for enhancing the functionality of a decompression box for use in a television program delivery system, the enhanced functionality using a control information stream that provides the decompression box with menu generation capability, the decompression box initially having the capability to decompress video, the upgrade module comprising:

an electronic connection to the decompression box, whereby the control information stream may be received from the decompression box;

a demultiplexer, wherein the control information stream is demultiplexed into graphics and text;

a combiner, electronically connected to the demultiplexer, wherein the combiner uses the demultiplexed graphics and text to produce a menu generation signal; and

a microprocessor, electronically connected to the combiner, wherein the microprocessor causes the menu generation signal to be transferred to the decompression box to be processed for display.

35. An upgraded set top converter for use in a television program delivery system, the set top converter upgraded for enhanced functionality that provides the set top converter with menu generation capability using a control information stream received from a remote location, the upgraded set top converter comprising:

an expansion card interface, wherein the control information stream is received from the remote location and wherein the expansion card interface can accept a card; and

a menu generation card, electronically connected to the expansion card interface, and comprising:

a combiner, whereby a menu generation signal is produced by the combiner and output through the expansion card interface to be processed for display of a menu.

* * * * *

UNITED STATES PATENT AND TRADEMARK OFFICE
CERTIFICATE OF CORRECTION

PATENT NO. : 5,990,927
DATED : November 23, 1999
INVENTOR(S) : John S. Hendricks, et al.

Page 1 of 2

It is certified that error appears in the above-identified patent and that said Letters Patent is hereby corrected as shown below:

Title page, page 2,

Item [56], References Cited, add references (Foreign Patents):

-- 234223 11/11/94 Taiwan
236065 12/11/94 Taiwan
235359 12/01/94 Taiwan --

Column 7,

Line 8, replace "222" with -- 212 --

Column 10,

Line 12, replace "statistics" with -- statistical --

Column 11,

Line 66, replace "200" with -- 900 --

Column 12,

Line 36, replace "immediately" with -- Immediately --

Column 19,

Line 53, replace "224" with -- 214 --

Column 22,

Line 26, replace "224" with -- 214 --

Column 23,

Line 12, delete "is"

UNITED STATES PATENT AND TRADEMARK OFFICE
CERTIFICATE OF CORRECTION

PATENT NO. : 5,990,927
DATED : November 23, 1999
INVENTOR(S) : John S. Hendricks, et al.

Page 2 of 2

It is certified that error appears in the above-identified patent and that said Letters Patent is hereby corrected as shown below:

Column 28,
Line 28, after “**may**” insert -- **be** --

Column 30,
Line 32, replace “**It**” with -- **it** --

Column 41,
Line 13, replace “**noting**” with -- **notifying** --

Claims,
Claim 13, column 45,
Line 11, replace “**the the**” with -- **the** --

Signed and Sealed this

Thirtieth Day of October, 2001

Attest:

Nicholas P. Godici

Attesting Officer

NICHOLAS P. GODICI
Acting Director of the United States Patent and Trademark Office