

*May Contain Confidential Business Information
Subject to Protective Order*

UNITED STATES INTERNATIONAL TRADE COMMISSION

Washington, D.C.

In the Matter of

**CERTAIN DIGITAL VIDEO RECEIVERS,
BROADBAND GATEWAYS, AND
RELATED HARDWARE AND
SOFTWARE COMPONENTS**

Inv. No. 337-TA-1158

**INITIAL DETERMINATION ON VIOLATION OF SECTION 337 AND
RECOMMENDED DETERMINATION ON REMEDY AND BOND**

Administrative Law Judge MaryJoan McNamara

(July 28, 2020)

Appearances:

For the Complainants Rovi Corporation and Rovi Guides, Inc.:

Douglas A. Cawley, Esq. and Richard A. Kamprath, Esq. of McKool Smith, P.C., Dallas, TX.

John B. Campbell, Esq., Joshua W. Budwin, Esq., and Leah Buratti, Esq. of McKool Smith, P.C., Austin, TX.

Mathew J. Rizzolo, Esq. of Ropes & Gray LLP, Washington, D.C.

For the Respondents Comcast Corporation, Comcast Cable Communications, LLC, Comcast Cable Communications Management, LLC, and Comcast Holdings Corporation:

Bert C. Reiser, Esq. and Jamie D. Underwood, Esq. of Latham & Watkins LLP, Washington, DC.

Michael A. David, Esq. of Latham & Watkins LLP, New York, NY

Ashok Ramani, Esq., David J. Lisson, Esq., and Micah G. Block, Esq. of Davis Polk & Wardwell LLP, Menlo Park, CA.

Krishnan Padmanabhan, Esq. of Winston & Strawn LLP, New York, NY.

***May Contain Confidential Business Information
Subject to Protective Order***

argued that any “simultaneous invention” assertion cannot overcome Comcast’s failure to establish a *prima facie* case of obviousness. (CRBr. at 58.).

Rovi’s argument is correct. Generally, “secondary considerations or objective indicia of non-obviousness” are considered to ensure that “an invention appearing to have been obvious in light of the prior art was not.” *Apple Inc. v. Samsung Elecs. Co.*, 839 F.3d 1034, 1052 (Fed. Cir. 2016) (quotation omitted). Here, Comcast has not established a *prima facie* case for obviousness of claims 5 and 15 of the ’445 patent. Furthermore, the lone secondary consideration Comcast identified does not amount to “substantial evidence” of obviousness.

Accordingly, the secondary considerations that the Private Parties articulated do not disturb Comcast’s failure to establish a *prima facie* case of obviousness of claims 5 and 15 of the ’445 patent.

VII. U.S. PATENT NO. 7,200,855

A. Overview of the ’855 Patent

The ’855 patent, entitled “Method and Apparatus of Multiplexing a Plurality of Channels in a Multimedia System,” was filed on May 24, 2001 as U.S. Application No. 09/864,602 (“the ’602 application”). (JX-0003 (’855 patent) at (21), (22).). The ’602 application issued as the ’855 patent on April 3, 2007, and names Indra Laksono as the sole inventor. (*Id.* at (75).). The ’855 patent is assigned on its face to VIXS Systems, Inc. and was subsequently assigned to Rovi Guides, Inc. (*Id.* at (73); JX-0009.).

The ’855 patent generally relates to a “method and apparatus for multiplexing a plurality of channels within a multimedia system includes processing that begins by receiving a plurality

***May Contain Confidential Business Information
Subject to Protective Order***

of channels from a multimedia source.”¹¹⁷ (JX-0003 at Abstract.).

For example, the plurality of channels may correspond to channels [i.e. television or cable channels] provided via a satellite connection, cable connection, NTSC broadcast, HDTV broadcast, VCR, DVD, laser disk player, et cetera. (*Id.* at 5:46-61.). The processing of the plurality of channels then continues when, e.g., a multimedia server, described in more detail below, receives a plurality of channel selection commands from client modules. The client modules are affiliated with client devices (e.g., television, personal computer, lap top computer, etc.) that are requesting access to a particular channel of the plurality of channels. (*Id.*). The processing for multiplexing a plurality of channels continues by selecting a channel of the plurality of channels for each of the channel selection commands to produce selected channels. (*Id.* at 5:62-6:3.). As such, for each channel selection command, a corresponding channel is selected from the plurality of channels. (*Id.*). The processing continues by encoding the selected channels based on a data conveyance protocol (e.g., encoding scheme and/or modulation scheme). (*Id.*). The encoded channel data is then conveyed to a plurality of clients. (*Id.*).

In Figure 33 below, multimedia server 12 receives a plurality of channels from a multimedia source 24. (JX-0003 at 6:14-16.). Multimedia server 12 communicates with client modules 14, 16, 18, 20 and 22 using a communication path. (*Id.* at 6:26-27.). Client modules 14, 16, 18, 20 and 22 connect to various client devices 26, 28, 30, 32 and 34. (*Id.* at 6:11-14.).

¹¹⁷ “[T]he present invention provides a method and apparatus for multiplexing a plurality of channels within a multimedia system. Such a method and apparatus includes processing that begins by receiving a plurality of channels from a multimedia source. For example, the plurality of channels may correspond to channels provided via a satellite connection, cable connection, NTSC broadcast, HDTV broadcast, et cetera. In addition, or in the alternative, the plurality of channels may be provided by a group of video sources such as a VCR, DVD, laser disk player, et cetera. The processing then continues by receiving a plurality of channel selection commands from client modules. The client modules are affiliated with client devices (e.g., television, personal computer, lap top computer, etc.) that are requesting access to a particular channel of the plurality of channels.” (JX-0003 at 5:46-61.).

Each of these components is described in more detail below.

Figure 33: In-Home Local Area Network with Multimedia Source

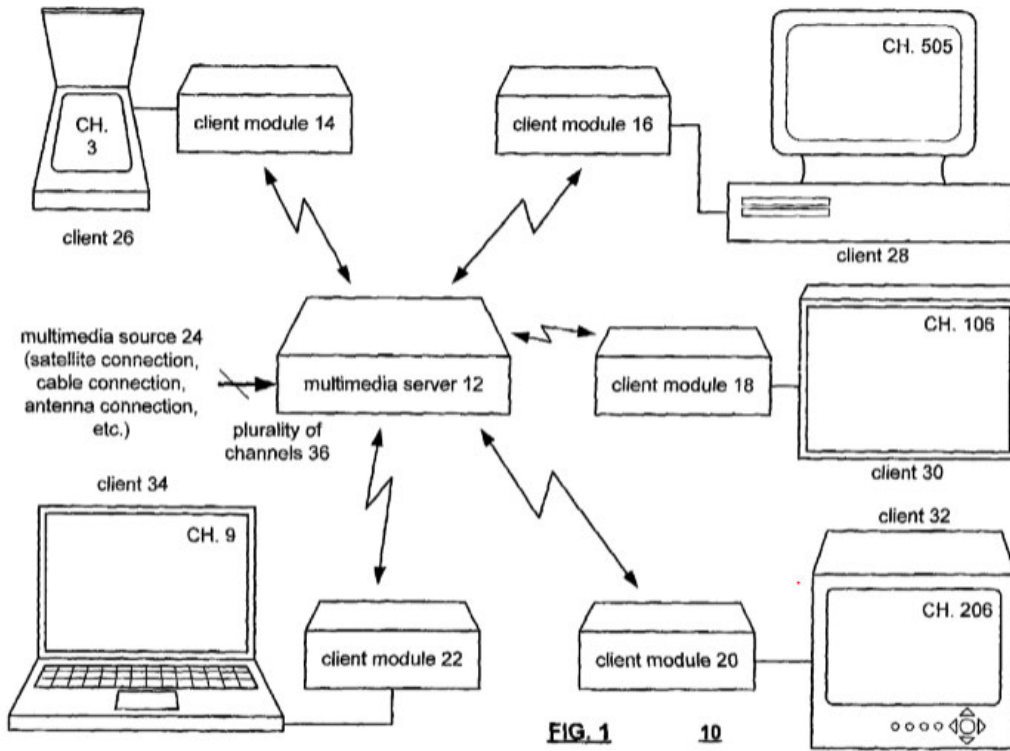

(JX-0003 at Fig. 1.).

The multimedia source 24 shown in Figure 33 above may be a satellite connection, cable connection, antenna connection for NTSC television broadcast, HDTV broadcast, PAL broadcast, etc. (*Id.* at 6:16-19.).

The multimedia server 12 may be a standalone device, may be incorporated in a satellite receiver, set-top box, cable box, HDTV tuner, home entertainment receiver, etc. (*Id.* at 6:20-23.). The multimedia server 12 communicates with the plurality of client modules 14-22 via a communication path, which may be a radio frequency communication path, a wire line connection, an infrared connection, and/or any other means for conveying data. (*Id.* at 6:26-30.).

***May Contain Confidential Business Information
Subject to Protective Order***

As shown above in Figure 33, each client module is operably coupled to one of the clients. (*Id.* at 6:35-36.). For example, client module 14 is operably coupled to client 26, which is representative of a personal digital assistant. (*Id.* at 6:36-38.). Client module 16 is operably coupled to client 28, which is representative of a personal computer. (*Id.* at 6:38-39.). Client module 18 is operably coupled to client 30, which is representative of a monitor (e.g., LCD monitor, flat panel monitor, CRT monitor, etc.). (*Id.* at 6:40-42.). Client module 20 is operably coupled to client 32, which may be a television set, high definition television (HDTV), standard definition television (SDTV), a home theatre system, et cetera. (*Id.* at 6:45-48.). Client module 22 is operably coupled to client 34, which is representative of a laptop computer. (*Id.* at 6:48-50.).

Each of the clients 26-34, via its associated client module 14-22, selects one or more channels from the plurality of channels 36. (*Id.* at 6:57-59.). For example, as shown above in Figure 33, client 26 has selected channel 3 of the plurality of channels for viewing. (*Id.* at 59-62.). Accordingly, client module 14 relays the channel selection of channel 3 to the multimedia server 12. (*Id.* at 6:60-62.). The multimedia server 12 selects channel 3 from the plurality of channels 36. (*Id.* at 6:62-63.). The data corresponding to channel 3 is then multiplexed with the data for the other channels and transmitted from the multimedia server 12 to each of the client modules 14-22. (*Id.* at 63-64.). Client module 14 monitors the transmission from the multimedia server 12 and extracts the data corresponding to channel 3. (*Id.* at 6:64-7:1.). The extracted data for channel 3 is then provided to the client 26 for display. (*Id.* at 7:1-3.).

1. Asserted Claims

Rovi asserted claims 60 and 63. (CBr. at 49.). Claim 60 depends from claim 59 which depends from independent claim 53. Independent claim 53 is reprinted with reference characters

*May Contain Confidential Business Information
Subject to Protective Order*

[a-g] added to facilitate discussion of the claim limitations. Dependent claims 59, 60, and 63 are also reprinted below:

Table No. 10: Claim 53 of the '855 Patent

Cl. 53	Element
53 <pre>[pre]</pre>	An apparatus for multiplexing channels in a multimedia system, the apparatus comprises:
53[a]	processing module; and
53[b]	memory operably coupled to the processing module, wherein the memory includes operational instructions that cause the processing module to:
53[c]	receiving a channel from each of a plurality of sources to produce a plurality of channels;
53[d]	receiving, from a plurality of clients, a plurality of channel selection requests by monitoring shared bus at specific time intervals, identifying a data frame at one of the specific time intervals that contains at least a portion of one of the plurality of channel selection requests, decoding, based on a data conveyance protocol of the multimedia system, the data frame to recapture the at least a portion of the one of the plurality of channel selection requests; and
53[e]	processing the plurality of channel selection requests to determine whether the request can supported, and, if so, producing a plurality of channel selection commands, wherein each of the plurality of channel selection commands includes an identity of one of the plurality of sources, and an identity of the channel;
53[f]	selecting a channel of the plurality of channels per channel selection command of the plurality of channel selection command to produce selected channels; and
53[g]	encoding each of the selected channels based on the data conveyance protocol of the multimedia system to produce a set of encoded channel data.

59. The apparatus of claim 53, wherein the memory further comprises operational instructions that cause the processing module to encoding each of the selected channels

*May Contain Confidential Business Information
Subject to Protective Order*

by:

framing data of each of the selected channels into a frame that includes header section and a data section, wherein the header section includes at least one of identity the selected channel, type of data of the selected channel, identity of the multimedia source, encryption enable/disable, type of encryption, compression enable/disable, type of compression, and frame number.

60. The apparatus of claim 59, wherein the memory further comprises operational instruction that cause the processing module to:

convey the frame in accordance with at least one of: a time division multiplexing data conveyance protocol, and frequency division multiplexing data conveyance protocol.

63. The apparatus of claim 53, wherein the memory further comprises operational instructions that cause the processing module to:

encrypt [the] selected channels prior to encoding.

(JX-0003 at cl. 53, 59, 60, 63.).

2. Claim Construction

Table No. 11: Construction of Agreed Upon Claim Term

Claim Term	Adopted Construction
“channel selection request” (Claims 1, 53)	data that identifies a particular channel and at least one of the clients (<i>Markman</i> Order, App. A at 50)

Table No. 12: Constructions of Disputed Claim Terms

Claim Term	Adopted Construction
“An apparatus for multiplexing channels in a multimedia system” (Claim 53)	The preamble is limiting only to the environment in which the invention operates, and the preamble does not add steps or components to the recited claim (<i>Markman</i> Order, App. A at 50-51)
“channel selection command”	command related to selection of a channel

*May Contain Confidential Business Information
Subject to Protective Order*

Claim Term	Adopted Construction
(Claims 53)	Alternatively, plain and ordinary meaning (<i>Markman</i> Order, App. A at 52)
“shared bus” (Claim 53)	a bus, located within a multimedia server, that is shared by components of that multimedia server (<i>Markman</i> Order, App. A at 55)
“identify[ing] a data [frame / packet] at one of the specific time intervals that contains at least a portion of one of the plurality of channel selection [commands/requests]” (Claim 53)	determin[e/ing] that a data [frame / packet] at one of the specific time intervals contains at least a portion of one of the plurality of channel selection [commands / requests] (without recapturing the at least a portion of one of the plurality of channel selection [commands / requests] via decoding) (<i>Markman</i> Order, App. A at 59-60)

B. Infringement

1. Infringement Overview

The Private Parties stipulated that there are three (3) representative product groups of user equipment that Comcast provides to its subscribers that Rovi contended infringe the '855 patent: [REDACTED]

[REDACTED] (JX-0067C.). The Private Parties also stipulated that [REDACTED]

[REDACTED]. (*Id.*)

During the Hearing, Comcast and its expert for the '855 patent, Dr. Sandeep

***May Contain Confidential Business Information
Subject to Protective Order***

Chatterjee,¹¹⁹ failed to provide any argument or evidence that the Accused Gateways do not practice several claim limitations. Instead, Comcast provided non-infringement arguments with respect to only two (2) elements in claim element 53[d]: (i) monitoring a shared bus at specific time intervals; and (ii) identifying a data frame at one of the specific time intervals that contains at least a portion of one of the plurality of channel selection requests. (RDX-0002C.0014; Tr. (Chatterjee) at 1306:4-16.). Therefore, Comcast has waived argument with respect the other claim elements under Ground Rule 10.1. (G.R. 10.1 (“If . . . the party who raised the issue or made the argument did not adduce evidence on the same during the evidentiary hearing, . . . it shall be deemed waived.”)).

For the reasons discussed in Sections VII.B.2, below, Rovi has met its burden and proven that the 855 Accused Products practice claims 60 and 63 of the ’855 patent.

2. The 855 Accused Products Practice Claims 60 and 63 of the ’855 Patent

a) Claim 53

i. 53[pre]: “An apparatus for multiplexing channels in a multimedia system, the apparatus comprises”

Rovi and Comcast both contended that the preamble is limiting. (*See, e.g.*, Joint CC Chart at 6.). Rovi argued that the preamble is limiting “but only to the environment in which the

¹¹⁹ When he testified during the Hearing on January 27, 2020, Dr. Sandeep Chatterjee was a technology expert and CEO of Experantis. (RX-0381 at 2; Tr. (Chatterjee) at 1297:23-1300:4.). Dr. Chatterjee earned an M.S. in electrical engineering and computer science, and a Ph.D. in computer science from the Massachusetts Institute of Technology (“MIT”). (Tr. (Chatterjee) at 1297:23-1298:2.). Comcast identified Dr. Chatterjee as an expert to testify about the technical background of the ’855 patent; issues related to the alleged infringement of the ’855 patent by the 855 Accused Products and Comcast’s design alternatives. Additionally, Dr. Chatterjee was called to testify about the design, structure, function, and operation of the 855 Accused Products and Comcast’s design alternatives. He testified with respect to the validity of the ’855 patent; whether the Rovi DI products practice the ’855 patent; and, relatedly, whether Rovi has satisfied the technical prong of the domestic industry for the ’855 patent. (*See* RPSt. at 2.).

***May Contain Confidential Business Information
Subject to Protective Order***

invention operates, and the preamble does not add steps or components to the recited claim.”

(*Id.*). Comcast asserted that “[t]he claimed apparatus is in a home as part of an in-home communication network” and that “the elements of the claim are in a multimedia server within a user’s home” (*Id.*). The *Markman* Order adopted Rovi’s proposal. (*Markman* Order, App. A at 50.).

Rovi maintained that the term “multimedia system” does not recite essential structure or steps, or give necessary life, meaning, and vitality to the claim. (CRMBR. at 31.). Rather, the term defines the environment in which the invention operates. “If the preamble ‘is reasonably susceptible to being construed to be merely duplicative of the limitations in the body of the claim (and was not clearly added to overcome a [prior art] rejection), we do not construe it to be a separate limitation.’” *TomTom, Inc. v. Adolph*, 790 F.3d 1315, 1324 (Fed. Cir. 2015) (quoting *Am. Med. Sys., Inc. v. Biolitec, Inc.*, 618 F.3d 1354, 1359 (Fed. Cir. 2010) at 1359 (quoting *Symantec Corp. v. Computer Assocs. Int’l, Inc.*, 522 F.3d 1279, 1288-89 (Fed. Cir. 2008))).

Shown below in Figure 34 is a graphical representation of how the 855 Accused Products correspond to the preamble.

Figure 34: Dr. Jones' Demonstrative Depicting a Multimedia System

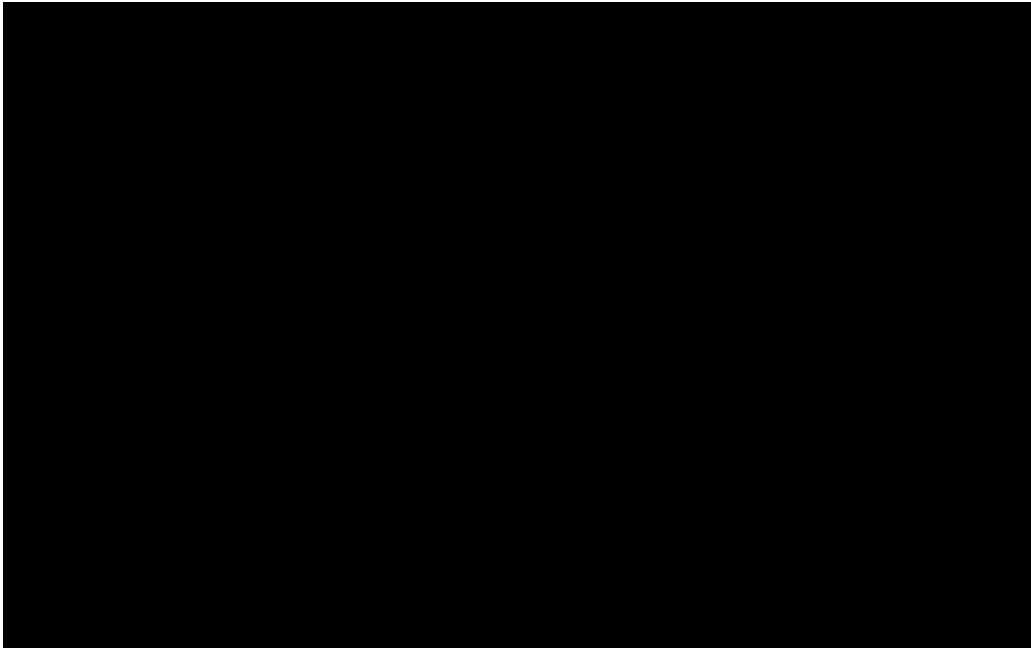

(CDX-0012C.0024 (based on RX-1035C (XG1 and XG2 HW Spec.) at 53 and CX-0874C (XG1v4 HW Spec.) at 10).

As depicted above in Dr. Mark Jones, Rovi's expert's demonstrative, [REDACTED]

[REDACTED]

[REDACTED]

Rovi's expert, Dr. Jones, explained that [REDACTED]

[REDACTED]

[REDACTED] (Tr. (Jones) at

419:5-7, 417:13-418:7, 418:23-419:7; CDX-0012C.0025; RX-1035C (XG1 and XG2 STB HW

¹²⁰ "MoCA is short for multimedia over coax alliance. It's a way of providing essentially a network connection between two devices using a cable, coax cable." (Tr. (Chamberlin) at 349:19-23.).

¹²¹ QAM stands for "[q]uadrature amplitude modulation, and it's the way that the audio visual data associated with a television program is represented so it can be sent efficiently over a network." (Tr. (Jones) at 424:3-6.).

*May Contain Confidential Business Information
Subject to Protective Order*

Spec.) at 48, 50, 53-55; CX-0874C (XG1v4 HW Spec.) at 10.). [REDACTED]

[REDACTED] (Tr. (Jones) at 429:10-14.).

Comcast did not provide evidence or testimony with respect to the preamble during the Hearing. Therefore, Comcast has waived argument on this issue under Ground Rule 10.1.

Accordingly, Rovi has proven by a preponderance of evidence that the 855 Accused Products meet the preamble of claim 53.

ii. 53[a]: “processing module”

[REDACTED]

[REDACTED]

[REDACTED]

[REDACTED]

[REDACTED]

[REDACTED]

[REDACTED]

[REDACTED]

[REDACTED]

[REDACTED]

[REDACTED]

¹²² See Tr. (David Chamberlin) at 370:8-20 (“Q. And at a high level, what do we see on CX 1424C, page 1? A. Well, we see the basic components here. Right in the middle here is our main component, which is the Broadcom 7449SOC. That performs most of the functionality that occurs in the set top box. Q. Let’s [sic] me stop you and ask you a couple questions. You said the BCM7449 is the SOC. What is an SOC? A. Short for system on chip. It’s a combination of a variety of functionalities to perform, set top box, and packaged it onto a single chip.”).

When he testified during the Hearing on January 22, 2020, Mr. David Chamberlin was a Distinguished Engineer at TiVo Solutions, Inc. (TSI). (Tr. (Chamberlin) at 340:15-17.). Rovi identified Mr. Chamberlin as a fact witness to testify generally with respect to Rovi’s DI Products, including the patent practicing features of Next-Gen, Next-Gen on Series 6, and Next-Gen on Series 7. (CPSt. at 2.). It should be noted that in Order No. 39, filed on June 11, 2020, Rovi’s Offer of Proof of evidence on TiVo Series 7 for Next Gen was rejected from admission into evidence, consistent with a bench ruling during the Hearing. (Order No. 39 (June 11, 2020)). TiVo Series 7 for Next Gen has been rejected as a proven Rovi DI Product, also consistent with Order No. 39.

*May Contain Confidential Business Information
Subject to Protective Order*

[REDACTED]

Comcast did not provide evidence or testimony regarding this claim limitation in its Pre-Hearing Brief or during the Hearing. Therefore, Comcast has waived argument on this issue under Ground Rules 7.2 and 10.1. (G.R. 7.2 (“Any contentions not set forth in detail [in the Pre-Hearing Brief] as required herein shall be deemed abandoned or withdrawn”); G.R. 10.1.).

Accordingly, Rovi has proven by a preponderance of evidence that the 855 Accused Products practice element 53[a] of claim 53.

- iii. 53[b]: “memory operably coupled to the processing module, wherein the memory includes operational instructions that cause the processing module to”*

[REDACTED]

¹²³ LNA is a “low noise amplifier that cleans up the signal.” (Tr. (Chamberlin) at 376:16-17.).

[REDACTED]

[REDACTED]

[REDACTED]

[REDACTED]

[REDACTED]

[REDACTED]

[REDACTED]

[REDACTED]

[REDACTED]

[REDACTED] However, Comcast did not provide evidence or testimony regarding this claim limitation during the Hearing. Therefore, Comcast has waived argument on this issue under Ground Rule 10.1.

For the foregoing reasons, Rovi has proven by a preponderance of evidence that the 855 Accused Products practice element 53[b] of claim 53.

iv. 53[c]: “receiv[e] a channel from each of a plurality of sources to produce a plurality of channels”

[REDACTED]

[REDACTED]

[REDACTED]

Figure 35: Receiving Channels from a Plurality of Sources

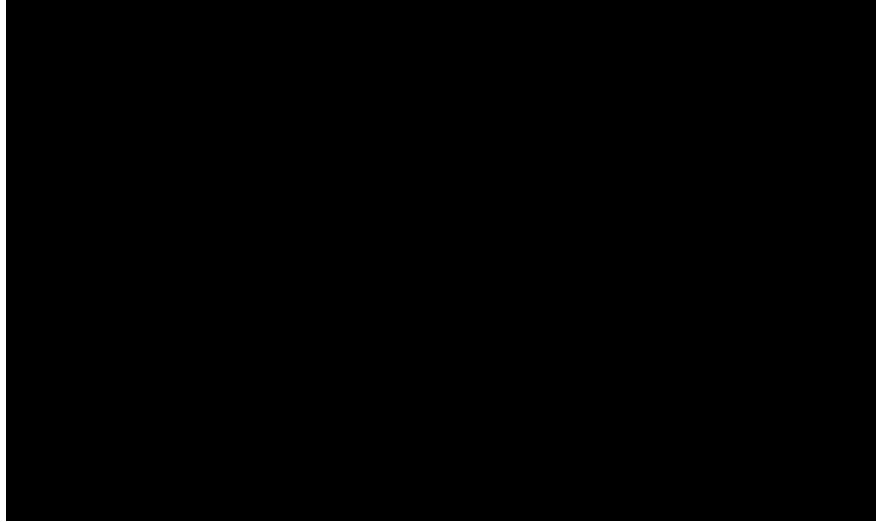

(CDX-0012C.0036; Tr. (Jones) at 429:8-14, 431:4-23; RX-1035C (XG1 and XG2 HW Spec.) at 48-54.).

Dr. Jones testified that [REDACTED]

[REDACTED]

[REDACTED]

[REDACTED]

[REDACTED]

[REDACTED]

[REDACTED]

[REDACTED]

[REDACTED]

[REDACTED]

[REDACTED]

[REDACTED]

¹²⁴ VOD is an acronym for “video on demand.” (*See, e.g.*, Tr. (Jones) at 544:22-23.).

*May Contain Confidential Business Information
Subject to Protective Order*

[REDACTED]

[REDACTED]

[REDACTED]

[REDACTED]

(RPBr. at 74.). Neither Comcast nor its expert, Dr.

Chatterjee, provided such testimony during the Hearing. Therefore, Comcast has waived argument on this issue and claim limitation under Ground Rule 10.1.

For these reasons, Rovi has proven by a preponderance of evidence that the 855 Accused Products practice element 53[c] of claim 53.

v. **53[d]: “receiv[e], from a plurality of clients, a plurality of channel selection requests by monitoring [a] shared bus at specific time intervals, identify[] a data frame at one of the specific time intervals that contains at least a portion of one of the plurality of channel selection requests, decod[e] based on a data conveyance protocol of the multimedia system, the data frame to recapture the at least a portion of the one of the plurality of channel selection requests”¹²⁵**

a. **53[d.1]: “receiv[e], from a plurality of clients, a plurality of channel selection requests by monitoring [a] shared bus at specific time intervals”**

[REDACTED]

[REDACTED]

[REDACTED]

[REDACTED]

¹²⁵ The Parties agreed that “channel selection request” means “data that identifies a particular channel and at least one of the clients.” (Joint CC Chart at 5.). The term “shared bus” has been construed in the *Markman* Order to mean “a bus, located within a multimedia server, that is shared by components of that multimedia server.” (*Markman* Order, App. A at 54-55.). The “identifying . . .” limitation was construed to mean “determin[e/ing] that a data [frame / packet] at one of the specific time intervals contains at least a portion of one of the plurality of channel selection [commands / requests] without recapturing the at least a portion of one of the plurality of channel selection [commands / requests] via decoding.” (*Id.* at 58-60.).

*May Contain Confidential Business Information
Subject to Protective Order*

[REDACTED]

The term “shared bus” was construed to mean “a bus, located within a multimedia server, that is shared by components of that multimedia server.” (*Markman* Order, App. A at 54-55.).

Dr. Jones explained that [REDACTED]

[REDACTED]

[REDACTED]

[REDACTED]

[REDACTED]

[REDACTED]

Figure 36: XG1v4 Block Diagram

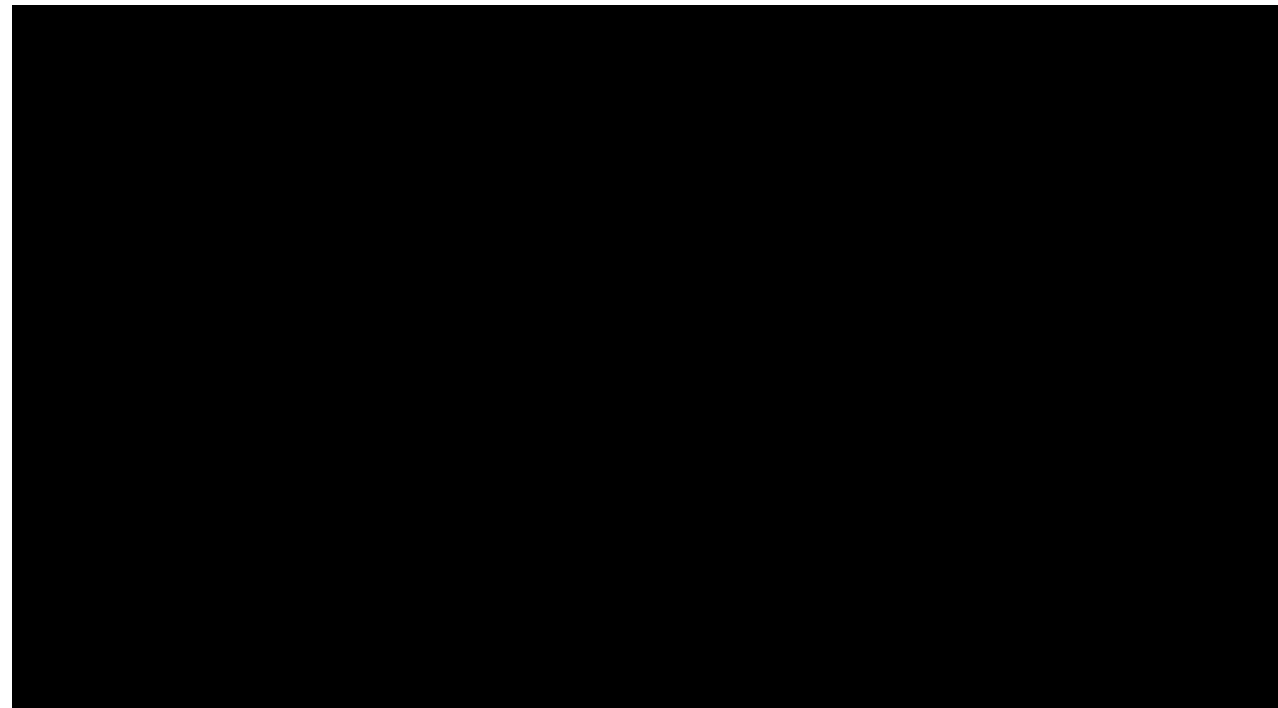

(RX-1661C (XG1v4 Block Diagram) at 2 (annotated by Rovi and copied from CBr. at 63); Tr. (Jones) at 568:16-17; Tr. (Chatterjee) at 1387:9-14.).

*May Contain Confidential Business Information
Subject to Protective Order*

A more detailed depiction of the shared bus is shown below in Figure 37.

Figure 37: Comcast's Shared Bus

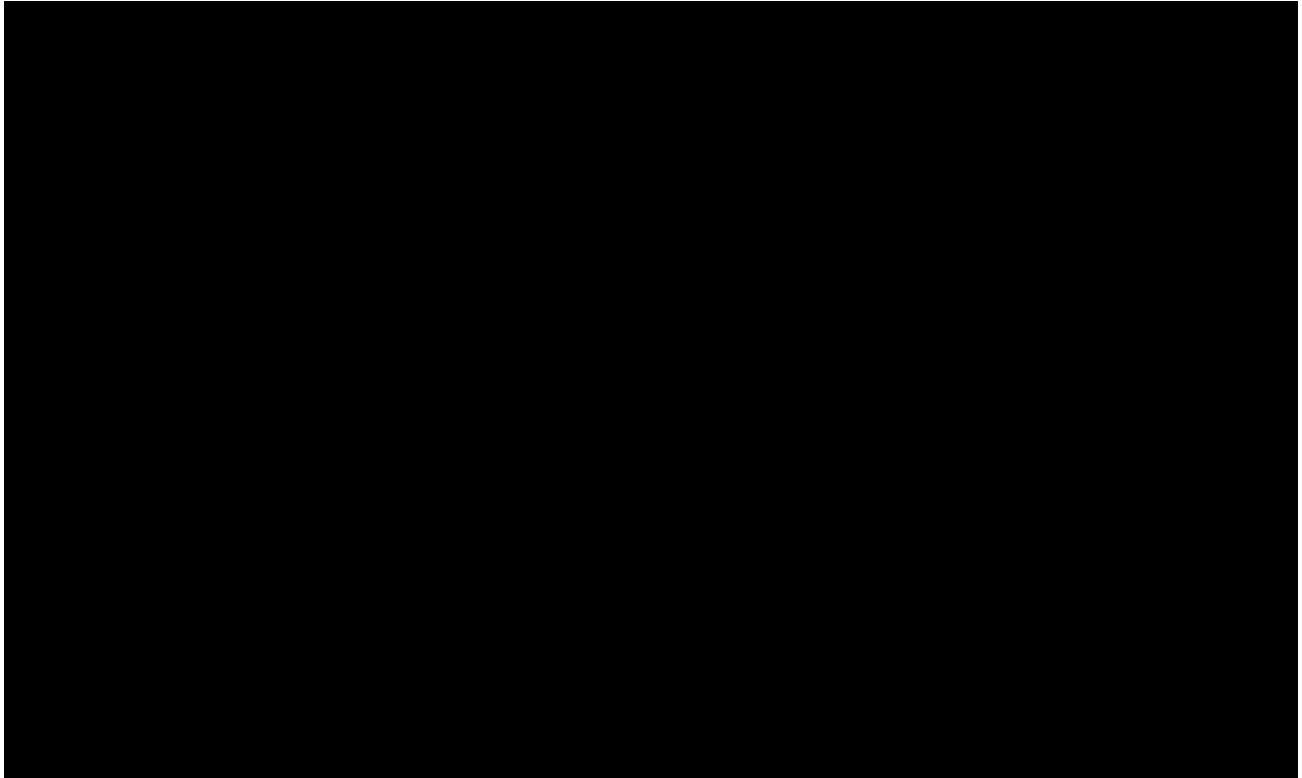

(RX-1661C.0005¹²⁶ ([REDACTED])); Tr. (Chatterjee) at 1388:12-19, 1389:15-1391:3.).

Dr. Jones testified that [REDACTED]

[REDACTED]

[REDACTED]

[REDACTED]

[REDACTED]

[REDACTED]

¹²⁶ According to Rovi, RX-1661C is a printout of a document produced by ARRIS (beginning at Bates ARRIS0017036) that was used in Dr. Jones's deposition. (CBr. at 64 n.19.). Rovi attached higher quality versions of RX-1661C.0002 (ARRIS0017037) and .0005 (ARRIS0017040) as Appendix E to its Initial Post-Hearing Brief. (*Id.*).

*May Contain Confidential Business Information
Subject to Protective Order*

[Redacted text block containing approximately 25 lines of blacked-out content]

*May Contain Confidential Business Information
Subject to Protective Order*

[REDACTED]

¹²⁷ TDMA stands for Time-Division Multiple Access. It is a form of signal communication that allows several users to share the same frequency channel by dividing the signal into different time slots. (*See, e.g., Tr. (Jones) at 451:20-21, 452:1-10* (“[A]n analogy would be if my four kids all want to use the TV at the same time, let’s say, I can give them time slots. I can say you can go for this 15 minutes, you get to go at these 15 minutes, you go at these 15 minutes, and so we divide up this resource by time. Same idea would happen here. We can divide up this access to this cable and communicate over it by time, but the time slots are much smaller than 15 minutes.”); CDX-0012C.0050.).

*May Contain Confidential Business Information
Subject to Protective Order*

[REDACTED]

[REDACTED]

[REDACTED]

[REDACTED]

[REDACTED]

[REDACTED]

[REDACTED]

[REDACTED]

[REDACTED]

[REDACTED]

[REDACTED]

[REDACTED]

[REDACTED]

[REDACTED]

[REDACTED]

[REDACTED]

[REDACTED]

[REDACTED]

[REDACTED]

[REDACTED]

[REDACTED]

[REDACTED]

[REDACTED]

[Redacted text block consisting of multiple horizontal bars]

Figure 38: Comcast's Counsel's Hand-Drawn Hearing Illustration



Figure 39: Comcast's Edited Exhibit 6

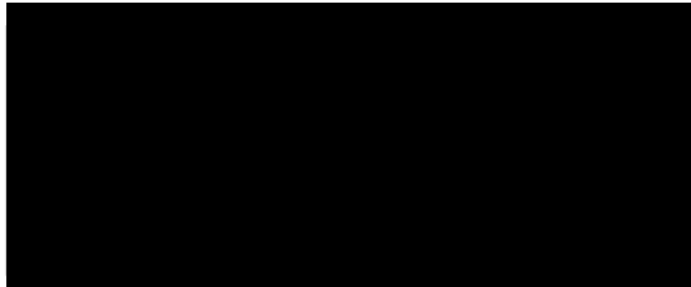

(RDX-0002C.0024; Tr. (Chatterjee) at 1328:7-1329:14.).

During cross-examination, Dr. Chatterjee agreed that [REDACTED]

[REDACTED]

[Redacted text block]

Figure 40: Dr. Chatterjee's Demonstrative of MoCA Monitoring

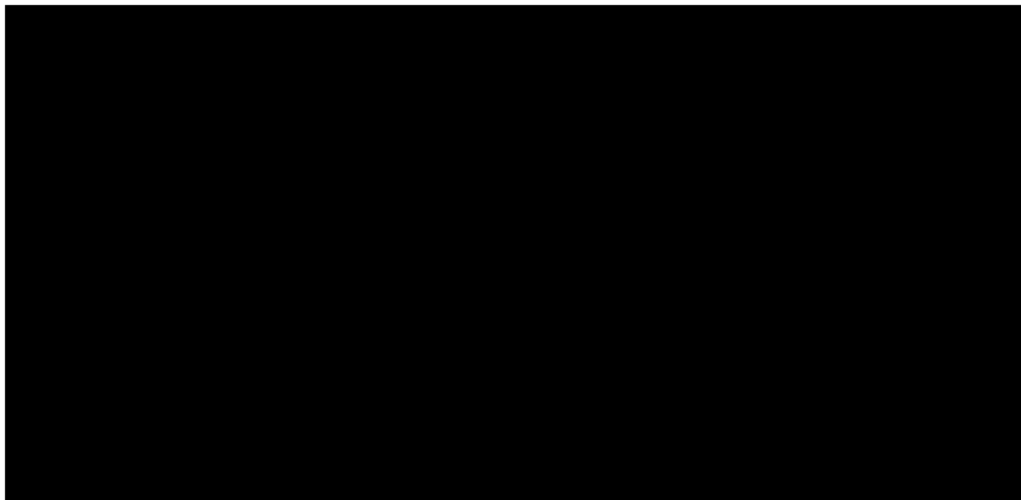

(RDX-0002C.0036.).

[Redacted text block]

*May Contain Confidential Business Information
Subject to Protective Order*

[Redacted]

[Redacted]

[Redacted]

[Redacted]

[Redacted]

[Redacted]

[Redacted]

[Redacted]

[Redacted]

[Redacted]

[Redacted]

[Redacted]

[Redacted]

[Redacted]

[Redacted]

[Redacted]

[Redacted]

[Redacted]

*May Contain Confidential Business Information
Subject to Protective Order*

[REDACTED]

[REDACTED]

[REDACTED]

[REDACTED]

[REDACTED]

[REDACTED]

[REDACTED]

[REDACTED]

[REDACTED]

[REDACTED]

[REDACTED]

[REDACTED]

[REDACTED]

[REDACTED]

[REDACTED]

[REDACTED]

[REDACTED]

[REDACTED]

[REDACTED]

[REDACTED]

[REDACTED]

[REDACTED]

[REDACTED]

*May Contain Confidential Business Information
Subject to Protective Order*

[REDACTED]

(*Id.* at 38:28-35.).

Notwithstanding Dr. Chatterjee’s testimony, Comcast failed to identify any disclosure in the ’855 patent that supports Comcast’s, or any of its witness,’ interpretation of monitoring as requiring [REDACTED].

[REDACTED]

b. 53[d.2]: “identify[] a data frame at one of the specific time intervals that contains at least a portion of one of the plurality of channel selection requests”

The Accused Gateways determine that a data frame ([REDACTED]) at one of the specific time intervals contains at least part of channel selection request ([REDACTED]) without decoding the data frame to recapture the channel selection request from client devices. (CDX-0012C.0053-54.). As discussed in Section VII.B(a)(v) with respect to limitation 53[d.1], the Accused Gateways receive channel selection requests from [REDACTED] (Tr. (Jones) at 463:22-464:8.). As shown

below in Figure 41, [REDACTED]

Figure 41: Identifying a Data Frame Containing a Channel Selection Request

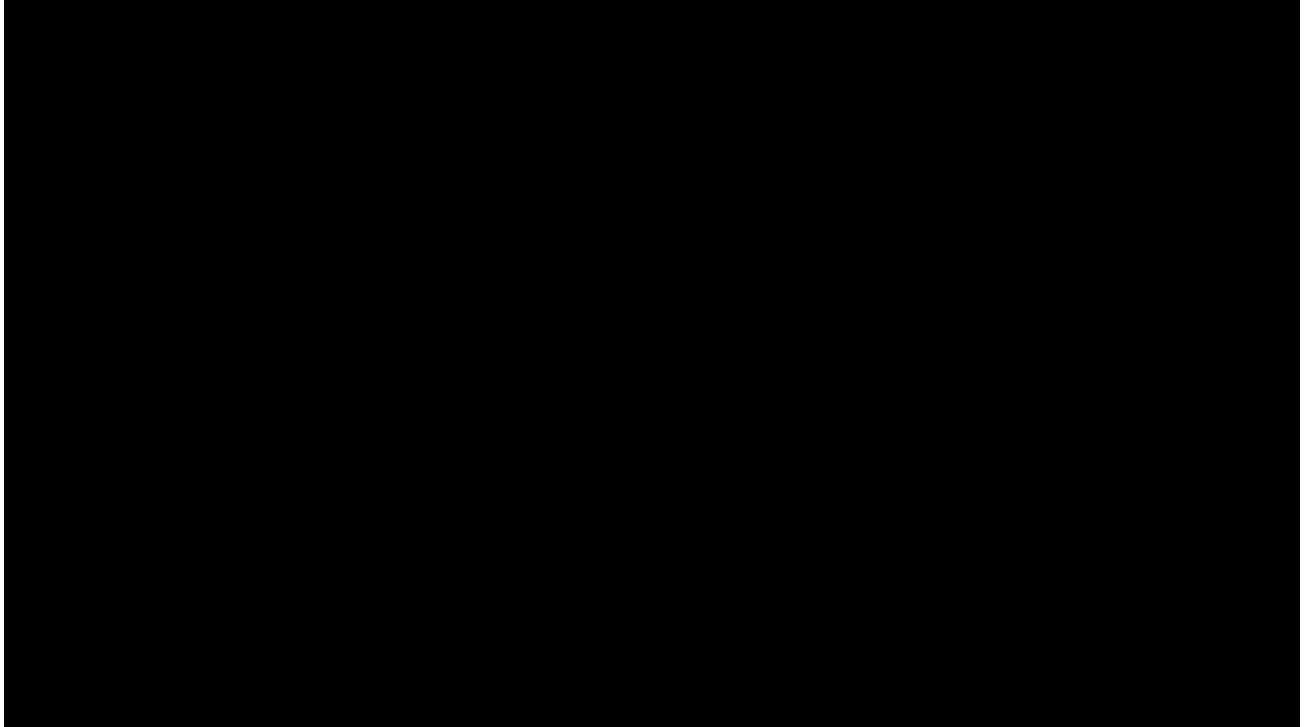

(CDX-0012C.0053; Tr. (Jones) at 463:22-464:8; CX-0788C, -0795C to -0800C, -0811C, -0816C to -0821C (capture files).)

Dr. Jones testified that [REDACTED] is the accused data frame. (Tr. (Jones) at 464:2-4.). The Accused Gateways determine that [REDACTED]

[REDACTED] Specifically, the Accused Gateways contain [REDACTED]

[REDACTED]

[REDACTED]

[REDACTED]

[REDACTED]

[REDACTED]

*May Contain Confidential Business Information
Subject to Protective Order*

The “identifying” limitation is met without recapturing the at least a portion of one of the plurality of channel selection requests via decoding to recapture the channel selection request (as required by the adopted construction) [REDACTED]

[REDACTED]. (*Id.* at 469:6-17; CDX-0012C.0056; *see also* Section VII.B.2.(a)(v)(c) (with respect to element 53[d.3], *infra*)). [REDACTED]

[REDACTED] (Tr. (Jones) at 469:6-17.).

Comcast argued that the Accused Gateways do not “identify[] a data frame at one of the specific time intervals” for several reasons, none of which are persuasive. Comcast first argued that [REDACTED]

[REDACTED]. As Rovi noted, the Parties did not seek a construction for the term “data frame,” and so it must receive its plain and ordinary meaning. *Phillips v. AWH Corp.*, 415 F.3d 1303, 1312-13 (Fed. Cir. 2005).

As Dr. Jones explained, the plain and ordinary meaning of the term “data frame” does not require that a frame has a header section separate from a body section. (Tr. (Jones) at 1708:4-11:12, 1713:7-15:2 (testifying about the UART and DOCSIS standards as examples of a data frame that does not require a separate data or body section), 1716:23-18:6 (discussing how an HTTP GET constitutes a data frame)). Dr. Jones persuasively testified, based upon the specification of the ’855 patent, that a person of ordinary skill would understand that a data frame is “a unit of data that is sent by one entity in the transmission and is meant to be received by one or more entities.” (*Id.* at 1709:13-16.). He explained that it is a “unit in the sense that its start is well defined,” (*id.* 1709:17-18, and that there is a “way to indicate when that unit is

*May Contain Confidential Business Information
Subject to Protective Order*

complete” (*id.* at 1710:6-7). Dr. Jones testified that [REDACTED]

[REDACTED]

[REDACTED]

[REDACTED]

[REDACTED]

[REDACTED]

[REDACTED]

[REDACTED]

Comcast argued that a data frame is always required to have a header section with a separate and distinct data section. (Tr. (Chatterjee) at 1398:4-10.). Comcast’s contention fails and was unpersuasive and unsupported for the following reasons. First, the ’855 patent claims undermine Comcast’s position due to claim differentiation. Claim 53 has no requirement of mutually exclusive sections within the claimed data frame. (JX-0003 at cl. 53.). In contrast, dependent claim 59 explicitly requires the data frame to contain additional features, including a header section and a data section. (*Id.* at cl. 59.).

In claim 53, the term “data frame” first appears in the “identifying” limitation of claim element 53[d]. (*Id.* at cl. 53; Tr. (Jones) at 1715:10-18.). The data frame in claim 53 corresponds to the channel selection request the gateway receives from a client. (Tr. (Jones) at 1715:19-23.).

In contrast, the frame in claim 59 corresponds to the video data being sent back to the client device. (Tr. (Jones) at 479:3-14.). In claim 59, this video data is encoded and sent back to the client by “framing data of each of the selected channels into a frame that includes [a] header section and a data section” (JX-0003 at cl. 59.). Therefore, unlike claim 53, claim 59

***May Contain Confidential Business Information
Subject to Protective Order***

recites a specific type of framing that requires both a header section and a data section. If the '855 patent always required a frame to have a header section separate from a data section, claim 59's additional language to that effect would be superfluous. *See, e.g., Akzo Nobel Coatings, Inc. v. Dow Chem. Co.*, 811 F.3d 1334, 1340 (Fed. Cir. 2016); *Karlin Tech. Inc. v. Surgical Dynamics, Inc.*, 177 F.3d 968, 972 (Fed. Cir. 1999). Even in claim 59, there is no requirement that the header section be mutually exclusive of the data section within the data frame, as Rovi pointed out. (CBr. at 76.).

Second, Dr. Chatterjee's Rebuttal Expert Report relies on the DOCSIS specification, which contains examples of data frames that do not require a body or data section, much less separate and mutually exclusive header and body sections. Instead, the examples Dr. Chatterjee used disclose data frames with a header and an optional data section.

Figure 42: Figure 6-1 of the DOCSIS Specification

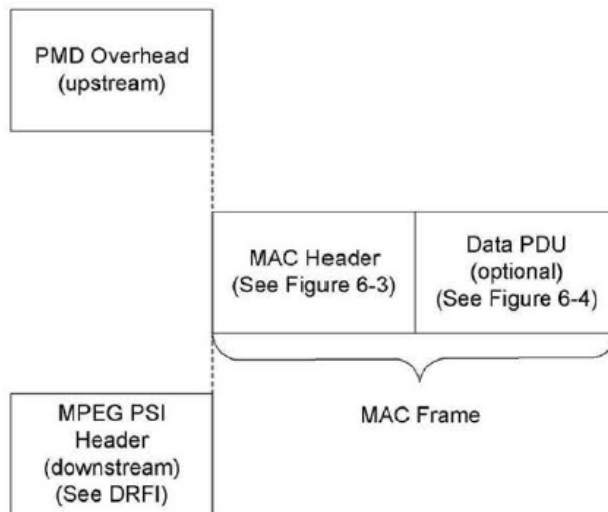

Figure 6-1 - Generic MAC Frame Format

(RX-1608 (DOCSIS Spec., Ex. G to Chatterjee Rebuttal Report) at 76-77; Tr. (Jones) at 1711:13-1715:2.).

[REDACTED]

[REDACTED]

[REDACTED] Dr. Jones explained that Figure 6-1 in the DOCSIS specification describes a MAC Frame where the data PDU (protocol data unit) is an optional portion of the frame. (Tr. (Jones) at 1713:7-14:8.). In other words, some MAC frames carry a data payload, and some have a header only (which itself contains data about the frame). (*Id.*). Therefore, Dr. Chatterjee’s opinion that data frames always contain a data section are not supported by the weight of the evidence.

Dr. Chatterjee based his interpretation of the term “data frame” on two (2) preferred embodiments disclosed in the ’855 patent, neither of which supports his opinion: 30:16-32 and 43:50-63 (Fig. 35). (Tr. (Chatterjee) at 1349:22-50:14; RDX-0002C.0041-.42.). The preferred embodiment at 30:16-32 describes packets and frames that contain channel data being sent from a gateway to a client (like in claim 59). The “data frame” that is “identif[ied]” in claim 53, however, is sent from a client to a gateway, and contains a channel selection request. Therefore, this portion of the specification describes a different frame than the one at issue in claim 53[d], which contains a channel selection request and not selected channel data.

Similarly, the preferred embodiment described in the ’855 patent at 43:50-63 and depicted in Figure 35, is merely one example of a possible implementation of the claimed invention. Nevertheless, it is not a preferred embodiment with a direct correlation to the asserted claims, because that preferred embodiment is performed by a “tuning module,” rather than the “apparatus for multiplexing channels” recited in claim 53. Accordingly, the two preferred embodiments in the ’855 patent specification that Dr. Chatterjee and Comcast rely upon cannot limit the plain and ordinary meaning of the term “data frame.” *Cont’l Circuits LLC v. Intel*

**May Contain Confidential Business Information
Subject to Protective Order**

Corp., 915 F.3d 788, 797 (Fed. Cir. 2019), *cert. denied*, 140 S. Ct. 648 (2019).

Additionally, Comcast contended that the Accused Gateways must determine that a data frame contains at least a part of a channel selection request *during* a specific time interval. (RDX-0002C.0048.). The '855 patent discusses *receiving* channel selection requests during a specific time interval. However, the '855 patent does not discuss anywhere the idea of or the actual act of determining that a data frame contains a channel selection request *during* that same time interval. Comcast's only basis for this argument is an apparent misinterpretation of Dr. Jones' deposition testimony. (*See* RDX-0002C.0055.).

Dr. Jones testified that the "identifying" claim limitation can be performed "based on the data in the frame." (CBr., App. C (Jones Dep. Tr.) at 179:15-180:2.). Dr. Jones expanded on this during the Hearing when he testified that [REDACTED]
[REDACTED]
[REDACTED] (Tr. (Jones) at 463:22-64:8, 465:20-25, 466:4-67:18.). Therefore, contrary to Dr. Chatterjee's testimony, Dr. Jones did not agree that the identifying must be performed during the time interval in which the data frame is received.

[REDACTED]
[REDACTED] This argument is duplicative of Comcast's second argument because it is based on the proposition that the data frame must be identified *during* the specific time interval, and therefore, fails for the same reasons. The '855 patent discloses *receiving* data frames during a specific time interval. However, the '855 patent does not discuss anywhere that a data frame contains a channel selection request during that same time interval.

Fourth, Comcast asserted that the only evidence Dr. Jones pointed to relates to packets,

*May Contain Confidential Business Information
Subject to Protective Order*

and not frames. However, as discussed during Dr. Jones' examination in Rovi's rebuttal case, Dr. Jones persuasively testified that a person of ordinary skill in the art would understand that the terms packets and data frames can be used interchangeably. (Tr. (Jones) at 1745:2-46:7.). Comcast's expert, Dr. Chatterjee, agreed, stating "although packets and frames refer to concepts and means of transporting data, a POSITA would understand that either can be used for transmitting information in a network as claimed in the '855 patent, such that disclosures as to one effectively disclose the other as well." (*Id.* (quoting and discussing Chatterjee Opening Invalidity Report at page 163, para. 304).). In addition, the '855 patent states that "one of average skill in the art will appreciate that the packets may be frames of data." (JX-0003 at 31:9-10.).

Comcast argued that "Dr. Jones cites to a capture file as evidence related to the identifying limitation of claim 53, but this capture is a packet capture and does not show a data frame." (RPBr. at 78.). Although Dr. Jones relied on packet captures in his analysis, his explanation of packet captures reflects packets that encapsulate the accused data frame ([REDACTED]). (Tr. (Jones) at 407:5-408:22.).

Therefore, for the reasons explained, Rovi has proven by a preponderance of evidence that the 855 Accused Products practice element 53[d.2] of claim 53.

c. 53[d.3]: "decod[e], based on a data conveyance protocol of the multimedia system, the data frame to recapture the at least a portion of the one of the plurality of channel selection requests"

[REDACTED]

[REDACTED]

[REDACTED]

*May Contain Confidential Business Information
Subject to Protective Order*

[REDACTED]

In its Pre-Hearing Brief, Comcast argued that the decoding limitation was not met for several reasons. However, Comcast did not offer evidence or testimony during the Hearing that the “decod[e]” claim limitation is not met. Therefore, Comcast has waived arguments on this limitation and associated issues under Ground Rule 10.1.

For the foregoing reasons, Rovi has proven by a preponderance of evidence that the 855 Accused Products practice element 53[d.3] of claim 53.

- vi. 53[e]: “select[] a channel of the plurality of channels per channel selection command of the plurality of channel selection command to produce selected channels”*

The Accused Gateways meet this claim limitation under either party’s construction of “channel selection command.”¹²⁸ (Tr. (Jones) at 470:12-471:3; CDX-0012C.0058-.61.).

Nevertheless, the *Markman* Order adopted Rovi’s proposed construction. (*Markman* Order,

¹²⁸ Rovi’s proposed construction was: “command related to selection of a channel.” (*See* Joint CC Chart at 6-7.). Comcast’s proposed construction was: “command that is derived from a channel selection request and that identifies a particular channel of a plurality of channels.” (*See id.*).

App. A at 52.).

As shown below in Figure 43, the Accused Gateways process the plurality of channel selection requests from client devices to determine whether the requests can be supported through [REDACTED].

Figure 43: Determining Whether Request Can Be Supported

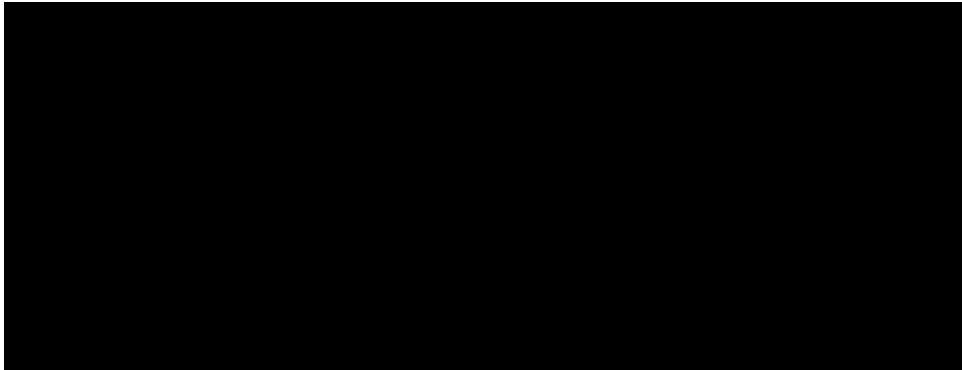

(CDX-0012C.0059; Tr. (Jones) at 471:9-472:13; CPX-0002C (Comcast code) at 717-22.).

Dr. Jones testified that [REDACTED]

[REDACTED]

[REDACTED]

[REDACTED]

[REDACTED]

[REDACTED]

[REDACTED]

[REDACTED]

[REDACTED]

¹²⁹ (*Id.*).

For example, if the channel selection is a request for live TV, [REDACTED]

[REDACTED]

[REDACTED]. Dr. Jones testified that based on

¹²⁹ HTTP is “short for hypertext transfer protocol. It’s the way that most web devices work.” (Tr. (Jones) at 348:13-15.).

*May Contain Confidential Business Information
Subject to Protective Order*

Comcast's source code, [REDACTED]
[REDACTED]
[REDACTED]
[REDACTED]
[REDACTED]
[REDACTED]

Each of the plurality of channel selection commands includes an identity of one of the plurality of sources and an identity of the channel. Dr. Jones explained that [REDACTED]

[REDACTED]
[REDACTED]
[REDACTED]
[REDACTED]
[REDACTED]
[REDACTED]
[REDACTED]
[REDACTED]
[REDACTED]
[REDACTED]
[REDACTED]

Comcast did not provide evidence or testimony during the Hearing with respect to this claim limitation during the Hearing. Therefore, Comcast has waived argument on this issue under Ground Rule 10.1.

Accordingly, Rovi has proven by a preponderance of evidence that the 855 Accused Products practice element 53[e] of claim 53.

*May Contain Confidential Business Information
Subject to Protective Order*

- vii. 53[f]: “select[] a channel of the plurality of channels per channel selection command of the plurality of channel selection command to produce selected channels”

The Accused Gateways select a channel based on the channel selection command and produce the selected channel (for transmission to the requesting client). Within the Accused Gateways, the [REDACTED]

[REDACTED]

Figure 44: Selecting a Linear QAM, Local DVR, and VOD Channel

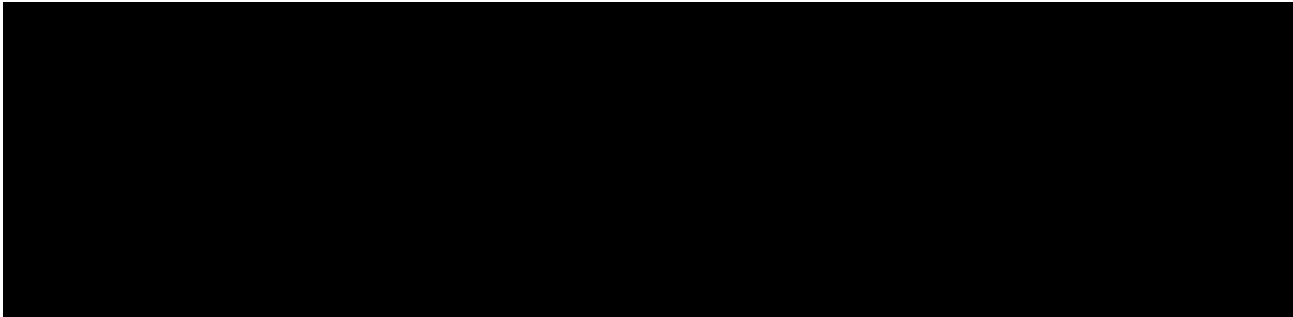

(CX-0179 ([REDACTED])); Tr. (Jones) at 475:14-476:17; CDX-0012C.0064; CPX-0002C (Comcast code) at 280-83, 477-78, 803-06.).

[REDACTED]

[REDACTED] (*Id.*). The XG1 and XG2 Hardware Specification provides additional evidence that the Accused Gateways produce selected channels. [REDACTED]

[REDACTED]

[REDACTED]

[REDACTED]

[REDACTED]

[REDACTED]

[REDACTED]

[REDACTED]

*May Contain Confidential Business Information
Subject to Protective Order*

Comcast did not provide evidence or testimony during the Hearing with respect to this claim limitation. Therefore, Comcast has waived argument on this issue and claim limitation under Ground Rule 10.1.

For the foregoing reasons, Rovi has proven by a preponderance of evidence that the 855 Accused Products practice element 53[f] of claim 53.

viii. 53[g]: “encod[e] each of the selected channels based on the data conveyance protocol of the multimedia system to produce a set of encoded channel data”

The Accused Gateways encode each of the selected channels based on [REDACTED]. As Dr. Jones testified, this claim limitation deals with transmitting the stream of channel data that has been requested to the accused STB that requested it. (Tr. (Jones) at 477:19-478:3.). The Accused Gateways [REDACTED]

Comcast did not provide evidence or testimony with respect to this claim limitation during the Hearing. Therefore, Comcast has waived argument on this issue under Ground Rule 10.1.

Accordingly, Rovi has proven by a preponderance of evidence that the 855 Accused Products practice element 53[g] of claim 53.

¹³⁰ “TCP/IP is the transport control protocol version of IP packets.” (Tr. (Jones) at 349:12-14.).

*May Contain Confidential Business Information
Subject to Protective Order*

b) Claim 59

- i. *“The apparatus of claim 53, wherein the memory further comprises operational instructions that cause the processing module to encoding each of the selected channels by: framing data of each of the selected channels into a frame that includes header section and a data section, wherein the header section includes at least one of identity the selected channel, type of data of the selected channel, identity of the multimedia source, encryption enable/disable, type of encryption, compression enable/disable, type of compression, and frame number.”*

The Accused Gateways encode the selected channels by framing data of the channels into a frame that includes a header section and a data section. (Tr. (Jones) at 479:3-25; CDX-0012C.0071.). As Dr. Jones testified, [REDACTED]

[REDACTED]

[REDACTED]

[REDACTED]

[REDACTED]

[REDACTED]

[REDACTED]

[REDACTED]

Comcast did not provide evidence or testimony with respect to this claim during the Hearing. Therefore, Comcast has waived argument on this issue under Ground Rule 10.1.

For the reasons explained, Rovi has proven by a preponderance of evidence that the 855 Accused Products practice claim 59.

*May Contain Confidential Business Information
Subject to Protective Order*

c) Claim 60

- i. “The apparatus of claim 59, wherein the memory further comprises operational instruction that cause the processing module to: convey the frame in accordance with at least one of: a time division multiplexing data conveyance protocol, and frequency division multiplexing data conveyance protocol.”*

The Accused Gateways convey frames in accordance with [REDACTED]

[REDACTED]

[REDACTED]

[REDACTED]

[REDACTED]

[REDACTED]

[REDACTED]

[REDACTED]

Comcast did not provide evidence or testimony regarding this claim during the Hearing. Therefore, Comcast has waived argument on this issue under Ground Rule 10.1.

For the reasons discussed above, Rovi has proven by a preponderance of evidence that the 855 Accused Products practice claim 60.

d) Claim 63

- i. “The apparatus of claim 53, wherein the memory further comprises operational instructions that cause the processing module to: encrypt th[e] selected channels prior to encoding.”*

The Accused Gateways contain operational instructions that cause the processing module to encrypt the selected channels prior to encoding. (Tr. (Jones) at 481:23-482:19; CDX-0012C.0078.). Figure 45 below, copied from CX-0179 ([REDACTED]), is a graphical representation of how the software components on the Accused Gateways operate.

Figure 45: Channel Encryption

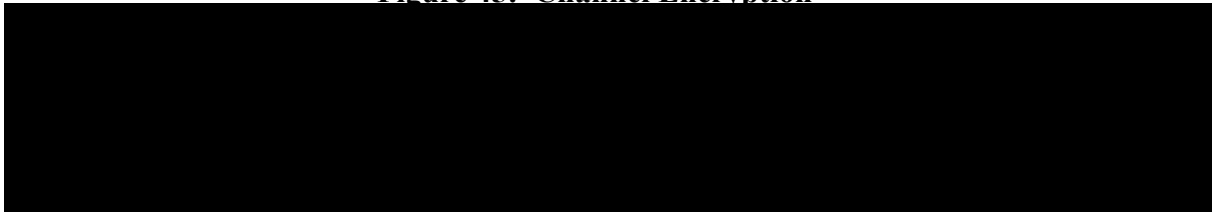

(CX-0179 (RDK-V Uses Cases); Tr. (Jones) at 482:3-8.).

In between the [REDACTED] [REDACTED] described in connection with element 53[e] above in Section VI.B.2(vi), the selected channels are encrypted using [REDACTED]. (Tr. (Jones) at 482:9-14; CPX-0002C (Comcast code) at 615, 943.). The channels are then encoded [REDACTED] [REDACTED] (*Id.*).

Comcast did not provide evidence or testimony with respect to this claim limitation during the Hearing. Therefore, Comcast has waived argument on this issue and claim limitation under Ground Rule 10.1.

Accordingly, Rovi has proven by a preponderance of evidence that the 855 Accused Products practice claim 63.

C. Comcast’s Alleged Non-Infringing Alternatives Are Hypothetical

During the Hearing, Comcast advanced two (2) purported non-infringing alternatives: (i)

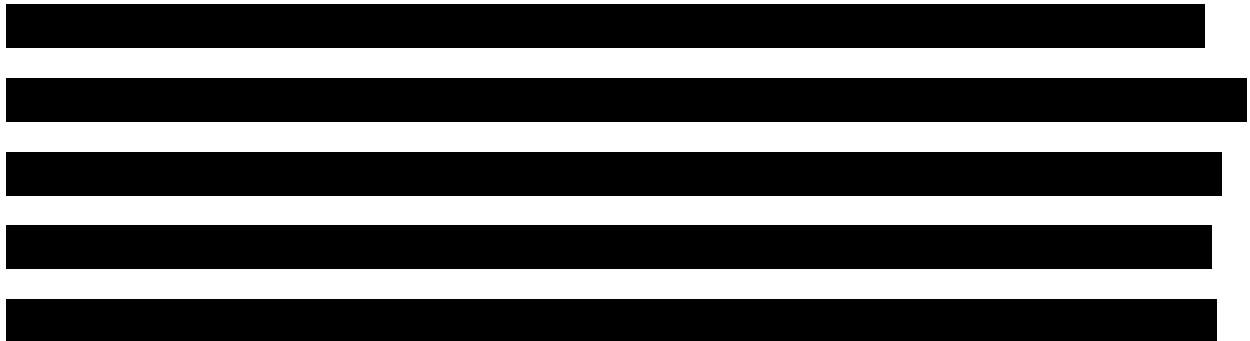

Rovi agreed that Comcast’s two (2) redesigns do not practice the asserted claims so long

***May Contain Confidential Business Information
Subject to Protective Order***

as the Accused Gateways are not capable of receiving [REDACTED] channel selection requests. (CBr. at 91; Tr. (Chatterjee) at 1402:19-20.). However, Comcast’s design-arounds are hypothetical redesigns because Comcast has not implemented either or shown that one, without the other, precludes infringement. (Tr. at 1402:10-11 (Comcast counsel confirmed that Comcast’s purported redesigns are “not a deployed redesign”); JX-0047C (Sandeep Nair Dep. Tr.)¹³¹ at 87:10-15.).¹³²

D. Technical Prong of Domestic Industry

1. Technical Prong Overview

Rovi asserted that it satisfies the technical DI prong because the following two (2) products practice the asserted claims of the ’855 patent: (i) Rovi’s Next-Gen Platform with Series 6 Gateway DVRs (the “Next-Gen Products”);¹³³ and (ii) Cox’s Contour 2 Platform products (“Cox’s Platform”). (Tr. (Jones) at 488:17-22; CDX-0012C.0091.).

For the reasons discussed below, Rovi has met its burden and proven that the 855 DI Products practice claims 60 and 63 of the ’855 patent.

¹³¹ When he was deposed on September 4, 2019, Mr. Sandeep Nair was the Director of Engineering at Comcast. (JX-0047C (Nair Dep. Tr.) at 13:18-22, 15:10-22.).

¹³² Mr. Sandeep Nair was designated as Comcast’s corporate representative to testify with respect to Comcast’s Accused Product redesigns. (JX-0047C (Nair Dep. Tr.) at 21:16-19.). Mr. Nair testified during his September 4, 2019 deposition that Comcast started working on its two (2) redesigns on approximately August 21, 2019. (*Id.* at 87:16-19.). The development of the code to [REDACTED] took “around three to four days” and the testing took “a few more days.” (*Id.* at 88:4-9.).

¹³³ In its Pre-Hearing Brief, Rovi asserted that the Next-Gen Products were domestic industry for two different types of communications: (i) TCP/IP-based communications; and (ii) HLS-based (HTTP Live Steaming) communications. Based on the adopted construction of the “identifying” term, Rovi agreed that the TCP/IP-based communications is not a domestic industry for the ’855 patent. (CBr. at 92-93 n.26; *Markman* Order, App. A at 59-60.). Therefore, Rovi’s domestic industry is based on the HLS based communications only. (*Id.*).

*May Contain Confidential Business Information
Subject to Protective Order*

2. The 855 DI Products (Next-Gen) Practice Claims 60 and 63 of the '855 Patent

a) Claim 53

i. 53[pre]: “An apparatus for multiplexing channels in a multimedia system, the apparatus comprises”

The Next-Gen Products¹³⁴ are apparatuses for multiplexing channels in a multimedia system (capable of use within a user’s home). The Next-Gen Products and the client devices comprise the multimedia system (even under Comcast’s more narrow proposed construction). (CDX-0012C.0097 (based on RX-0196C (Minos – Series 6 HW Spec.)); Tr. (Jones) at 492:11-493:1.). The Next-Gen Products multiplex channels to the client devices (such as televisions and personal computers). (Tr. (Jones) at 492:11-493:1.).

Comcast did not provide evidence or testimony regarding this claim limitation during the Hearing. Therefore, Comcast has waived argument on this issue under Ground Rule 10.1.

Accordingly, Rovi has proven by a preponderance of evidence that the Next-Gen Products meet the preamble of claim 53.

ii. 53[a]: “processing module”

The Next-Gen Products comprise a BCM7449 SoC processing module. (CX-0196 (TiVo Bolt Teardown); Tr. (Jones) at 493:4-12; CDX-0012C.0099.).

Comcast did not provide evidence or testimony regarding this claim limitation in its Pre-Hearing Brief or during the Hearing. Therefore, Comcast has waived argument on this issue under Ground Rules 7.2 and 10.1.

Accordingly, Rovi has proven by a preponderance of evidence that the Next-Gen

¹³⁴ The Next Gen Products do not include TiVo Series 7 for Next Gen since these were precluded from the Investigation by Order No. 39. (Order No. 39 (June 11, 2020).).

***May Contain Confidential Business Information
Subject to Protective Order***

Products practice element 53[a] of claim 53.

iii. 53[b]: “memory operably coupled to the processing module, wherein the memory includes operational instructions that cause the processing module to”

The Next-Gen Products comprise FLASH memory coupled to the SoC, wherein the memory includes operational instructions (source code) that cause the SoC to perform the limitations described below. (CX-0196 (TiVo Bolt Teardown); Tr. (Jones) at 493:13-494:1; CDX-0012C.0101; Tr. (Chamberlin) at 371:8-372:4 (describing Next-Gen Platform source code stored in flash memory and running on the SoC).

Comcast did not offer evidence or testimony with respect to this claim limitation in its Pre-Hearing Brief or during the Hearing. Therefore, Comcast has waived argument on this issue and claim limitation under Ground Rules 7.2 and 10.1.

For the foregoing reasons, Rovi has proven by a preponderance of evidence that the Next-Gen Products practice element 53[b] of claim 53.

iv. 53[c]: “receiv[e] a channel from each of a plurality of sources to produce a plurality of channels”

The Next-Gen Products are capable of receiving a plurality of channels from a plurality of sources including linear QAM channels and local DVR channels. (Tr. (Jones) at 494:4-23; CX-0196 (TiVo Bolt Teardown); CX-0742C (screenshots) at 1-2; CX-0794C (capture file); CDX-0012C.0103-.0104.).

Comcast did not provide evidence or testimony regarding this claim limitation during the Hearing. Therefore, Comcast has waived argument on this issue and claim limitation under Ground Rule 10.1.

For the reasons explained, Rovi has proven by a preponderance of evidence that the

**May Contain Confidential Business Information
Subject to Protective Order**

Next-Gen Products practice element 53[c] of claim 53.

- v. **53[d]: “receiv[e], from a plurality of clients, a plurality of channel selection requests by monitoring [a] shared bus at specific time intervals, identify[] a data frame at one of the specific time intervals that contains at least a portion of one of the plurality of channel selection requests, decod[e] based on a data conveyance protocol of the multimedia system, the data frame to recapture the at least a portion of the one of the plurality of channel selection requests”**

The Next-Gen Products are capable of receiving HTTP channel selection requests from clients/users STBs in the form of HTTP GET messages.

Figure 46: HTTP GET Messages

- Format of HTTP Get request:
 - HTTP Get `http://10.0.0.25:49152/<uri-prefix>/<session id>/<variant id>/<segment number>`
 - `<uri-prefix>` – “session-streaming” for HLS streaming in home
 - `<session id>` – ID of streaming session
 - `<variant id>` –format of picture, resolution, etc.
 - `<segment number>` – number of the requested segment (two-second chunk)

(CDX-0012C.0106 (based on CX-0794C (capture file)); Tr. (Jones) at 495:3-22; Tr. (Chamberlin) at 348:16-21 (testifying as to the same); CPX-0001C (Rovi code) at 8670-90; CDX-0005C.0001 (version of CDX-0012C (pictured above) used during testimony of David Chamberlin).).

As Mr. Chamberlin testified, the HTTP GET request identifies the channel that a client requests via the `<session id>` variable. (Tr. (Chamberlin) at 350:10-15.). Mr. Chamberlin also testified that the HTTP GET request also identifies the client that makes the channel selection request via the `<session id>` variable. (*Id.* at 350:16-21, 351:4-52:1 (describing the purpose of each of the variables in the HTTP GET request).).

In its Pre-Hearing Brief, Comcast stated that Dr. Chatterjee would testify that “the Next-

***May Contain Confidential Business Information
Subject to Protective Order***

Gen Platform does not use any ‘channel selection requests,’ as required by claim[] 53.” Comcast also stated that the purported ‘channel selection requests,’ that Rovi identified do not ‘identif[y] a particular channel’ as required by the parties’ agreed construction of the term.” (RPBr. at 90.). Dr. Chatterjee did not provide the described, proposed testimony during the Hearing. Therefore, Comcast has waived argument on this issue under Ground Rule 10.1.

Rovi presented evidence that the channel selection requests that Rovi identified include a <session id> variable which translates to a selected channel. (Tr. (Chamberlin) at 350:10-15, 350:16-21, 351:4-52:1 (describing the purpose of each of the variables in the HTTP GET request); CDX-0005C.0002 (depicting the variables in the HTTP GET request)).

For the foregoing reasons, Rovi has proven by a preponderance of evidence that the Next-Gen Products practice element 53[d] of claim 53.

vi. 53[e]: “select[] a channel of the plurality of channels per channel selection command of the plurality of channel selection command to produce selected channels”

The Next-Gen Products meet the identified limitation because, as Dr. Jones testified, the source code shows that the channel selection requests are processed to determine whether they can be supported and, if so, channel selection commands are produced. (Tr. (Jones) at 497:6-498:2; CPX-0001C (Rovi code) at 6858-928, 8658-70, 8763-96, 10167-69.). The TVNetStreamSession object is a channel selection command which is derived from the channel selection requests that the TiVo Series 6 gateways receive. It contains both the identity of the plurality of sources and the identity of the channel. (Tr. (Jones) at 497:13-21.). The TVNetStreamSession channel selection command is produced in response to the session ID contained in the HTTP GET channel selection request, after checking that the session ID can be supported. (*Id.* at 497:22-24.).

***May Contain Confidential Business Information
Subject to Protective Order***

Comcast did not provide evidence or testimony with respect to this claim limitation in its Pre-Hearing Brief or during the Hearing. Therefore, Comcast has waived argument on this issue under Ground Rules 7.2 and 10.1.

Accordingly, Rovi has proven by a preponderance of evidence that the Next-Gen Products practice element 53[e] of claim 53.

vii. 53[f]: “select[] a channel of the plurality of channels per channel selection command of the plurality of channel selection command to produce selected channels”

The Next-Gen Products are capable of selecting a channel of the plurality of channels per channel selection command of the plurality of channel selection commands to produce selected channels. (Tr. (Jones) at 498:7-499:25.). In response to the TVNetStreamSession channel selection command, the selected channel is returned to the client device as a stream of channel data. (*Id.* at 498:9-15; CX-0794C (capture file); CX-0742C (screenshots); Tr. (Chamberlin) at 358:24-66:3 (discussing the Next-Gen Product source code that processes the channel selection command to return the channel to the client); CPX-0001C (Rovi code) at 8658-70, 6858-928, 8797-833.). The selected channel is returned in the form of an HTTP GET response. (Tr. (Jones) at 498:19-21, 499:3-14.).

Comcast did not provide evidence or testimony regarding this claim limitation in its Pre-Hearing Brief or during the Hearing. Therefore, Comcast has waived argument on this issue under Ground Rules 7.2 and 10.1.

For the foregoing reasons, Rovi has proven by a preponderance of evidence that the Next-Gen Products practice element 53[f] of claim 53.

***May Contain Confidential Business Information
Subject to Protective Order***

- viii. 53[g]: “encod[e] each of the selected channels based on the data conveyance protocol of the multimedia system to produce a set of encoded channel data”***

The Next-Gen Products meet this limitation by encoding the channels according to HTTP (over TCP/IP over MoCA) to create encoded channel data. (Tr. (Jones) at 500:3-7; CX-0794C (capture file); Tr. (Chamberlin) at 366:19-368:23; CPX-0001C (Rovi code) at 8668-69, 8743-46, 8712-17, 8797-833, 10103-04.).

Comcast did not provide evidence or testimony regarding this claim limitation in its Pre-Hearing Brief or during the Hearing. Therefore, Comcast has waived argument on this issue under Ground Rules 7.2 and 10.1.

Accordingly, Rovi has proven by a preponderance of evidence that the Next-Gen Products practice element 53[g] of claim 53.

b) Claim 59

- i. “The apparatus of claim 53, wherein the memory further comprises operational instructions that cause the processing module to encoding each of the selected channels by: framing data of each of the selected channels into a frame that includes header section and a data section, wherein the header section includes at least one of identity the selected channel, type of data of the selected channel, identity of the multimedia source, encryption enable/disable, type of encryption, compression enable/disable, type of compression, and frame number.”***

The Next-Gen Products are capable of encoding each of the selected channels by framing data of each of the selected channels into a frame that includes header section and a data section, wherein the header section includes at least the type of compression. (Tr. (Jones) at 500:18-01:10.). The selected channels are encoded by framing the data into an HTTP response that includes a header section and a data section. (*Id.* at 498:16-499:14; CPX-0794C (capture file)).

***May Contain Confidential Business Information
Subject to Protective Order***

The HTTP header identifies the type of compression (MPEG). (Tr. (Jones) at 500:24-501:4; CX-0794C (capture file); CPX-0001C (Rovi code) at 8658-59, 8680; CDX-0012C.0117.).

Comcast did not provide evidence or testimony regarding this claim limitation in its Pre-Hearing Brief or during the Hearing. Therefore, Comcast has waived argument on this issue under Ground Rules 7.2 and 10.1.

For these reasons, Rovi has proven by a preponderance of evidence that the Next-Gen Products practice claim 59.

c) Claim 60

- i. “The apparatus of claim 59, wherein the memory further comprises operational instruction that cause the processing module to: convey the frame in accordance with at least one of: a time division multiplexing data conveyance protocol, and frequency division multiplexing data conveyance protocol.”***

The Next-Gen Products are capable of conveying the frame in accordance with MoCA, a time division multiplexing based data conveyance protocol. (Tr. (Jones) at 501:11-22; CX-0196 (TiVo Bolt Teardown).). MoCA uses a TDMA scheme. (*Id.*; CX-0915C (MoCA MAC/PHY Spec. v 2.0) at 33, 42, 44; CDX-0012C.0119.).

Comcast did not offer evidence or testimony with respect to this claim limitation in its Pre-Hearing Brief or during the Hearing. Therefore, Comcast has waived any argument on this issue under Ground Rules 7.2 and 10.1.

For the reasons discussed above, Rovi has proven by a preponderance of evidence that the Next-Gen Products practice claim 60.

*May Contain Confidential Business Information
Subject to Protective Order*

d) **Claim 63**

- i. *“The apparatus of claim 53, wherein the memory further comprises operational instructions that cause the processing module to: encrypt th[e] selected channels prior to encoding.”*

The Next-Gen Products are capable of encrypting the selected channels prior to encoding. (Tr. (Jones) at 501:23-02:25.). As one of Rovi’s fact witnesses, David Chamberlin, an engineer, explained, the segmenter in the Next-Gen Products’ source code performs encryption before the channel data is encoded using HTTP. (Tr. (Chamberlin) at 366:4-23 (describing the Next-Gen source code responsible for encryption and how it runs before the selected channels have been encoded via HTTP); Tr. (Jones) at 502:2-17; CPX-0001C (Rovi code) at 8819; CX-0794C (capture file); CDX-012C.0121.).

Comcast did not offer evidence or testimony with respect to this claim limitation in its Pre-Hearing Brief or during the Hearing. Therefore, Comcast has waived any argument on this issue under Ground Rules 7.2 and 10.1.

Accordingly, Rovi has proven by a preponderance of evidence that the Next-Gen Products practice claim 63.

E. [REDACTED]

Cox’s Contour 2 Platform includes [REDACTED]

[REDACTED]. (Tr. (Jones) at 503:6-13.). [REDACTED].

(Id.). Cox’s Contour 2 Platform is a syndication of the Comcast X1 Platform [REDACTED]

[REDACTED]

[REDACTED]

[REDACTED]

[Redacted]
[Redacted]
[Redacted]
[Redacted]
[Redacted]
[Redacted]
[Redacted]
[Redacted]
[Redacted]
[Redacted]
[Redacted]
[Redacted]
[Redacted]
[Redacted]
[Redacted]
[Redacted]
[Redacted]

[Redacted]
[Redacted]

[Redacted]
[Redacted]
[Redacted]

[Redacted]
[Redacted]
[Redacted]

[Redacted]
[Redacted]

*May Contain Confidential Business Information
Subject to Protective Order*

In its Pre-Hearing Brief, Comcast only mentioned that Cox's Contour 2 Platform [REDACTED]

[REDACTED]

[REDACTED]

[REDACTED]

[REDACTED]

[REDACTED]

[REDACTED]

[REDACTED]

[REDACTED] Comcast has also waived all other arguments with respect to Cox Contour 2 Platform DI under Ground Rule 10.1.

For the foregoing reasons, Rovi has proven by a preponderance of evidence that the Cox's Contour 2 Platform practice claims 60 and 63 of the '855 patent.

F. Invalidity

On January 27, 2020, Comcast withdrew all of its invalidity challenges to the '855 patent in Comcast Respondents' Notice of Withdrawal of Invalidity Arguments, Doc. ID No. 7000444 (Jan. 27, 2020). Therefore, Comcast has waived argument on the invalidity of the '855 patent Ground Rule 10.1.

VIII. INDIRECT INFRINGEMENT

A. Legal Standard

1. Indirect Infringement

Indirect infringement may be either induced or contributory. Direct infringement must first be established in order for a claim of indirect infringement to prevail. *BMC Res. v. Paymentech*, 498 F.3d 1373, 1379 (Fed. Cir. 2007).