

IN THE UNITED STATES PATENT AND TRADEMARK OFFICE

BEFORE THE PATENT TRIAL AND APPEAL BOARD

SAMSUNG DISPLAY CO., LTD.,
Petitioner,

v.

PICTIVA DISPLAYS INTERNATIONAL LTD.,
Patent Owner.

Case No. IPR2024-00855

Patent No. 8,314,547

**PETITION FOR *INTER PARTES* REVIEW OF U.S. PATENT NO.
8,314,547 UNDER 35 U.S.C. §§ 311–319 AND 37 C.F.R. § 42.100 *et seq.***

TABLE OF CONTENTS

I. INTRODUCTION 1

II. STANDING, MANDATORY NOTICES AND FEE AUTHORIZATION 1

III. SUMMARY OF CHALLENGE 2

IV. OVERVIEW OF THE '547 PATENT 4

 A. Prosecution History 7

V. LEVEL OF ORDINARY SKILL 9

VI. CLAIM CONSTRUCTION 10

VII. OVERVIEW OF PRIOR ART 10

 A. Igarashi (Ex. 1004) 10

 B. Shiotani (Ex. 1005)..... 11

 C. Pilcher (Ex. 1006)..... 13

 D. Dresevic (Ex. 1007)..... 14

VIII. APPLICATION OF PRIOR ART TO THE CHALLENGED CLAIMS 15

 A. Ground I: 1–5, 8–11, and 13 Are Obvious Based on Igarashi..... 15

 1. Independent Claim 1 15

 2. Dependent Claim 2: The optoelectronic device as claimed in claim 1, wherein the first wavelength spectrum comprises a blue wavelength range and the second wavelength spectrum comprises a yellow wavelength range. 25

3.	Dependent Claim 3: The optoelectronic device as claimed in claim 1, wherein the optoelectronic device has a non-yellow color impression.....	28
4.	Dependent Claim 4: The optoelectronic device as claimed in claim 1, wherein the filter layer is configured to convert the electromagnetic radiation having the third wavelength spectrum into an electromagnetic radiation from a non-visible wavelength range.....	30
5.	Dependent Claim 5: The optoelectronic device as claimed in claim 4, wherein the filter layer is further configured to absorb the electromagnetic radiation having the third wavelength spectrum.....	32
6.	Dependent Claim 8.....	32
7.	Dependent Claim 9: The optoelectronic device as claimed in claim 8, wherein the second filter layer is configured at least partially to absorb the electromagnetic radiation having the fourth wavelength spectrum.	35
8.	Dependent Claim 10: The optoelectronic device as claimed in claim 8, wherein the second filter layer is configured at least partially to reflect the electromagnetic radiation having the fourth wavelength spectrum.	36
9.	Dependent Claim 11: The optoelectronic device as claimed in claim 1, further comprising an encapsulation one of disposed upstream and disposed downstream of the structured layer in the beam path of the electromagnetic radiation emitted by the organic layer sequence.....	38
10.	Dependent Claim 13: The optoelectronic device as claimed in claim 1, wherein the electromagnetic radiation which is emitted by the optoelectronic device corresponds to a superimposition of the electromagnetic radiation having the first wavelength spectrum and the electromagnetic radiation having the second wavelength spectrum.....	40

B.	Ground II: Claim 12 Is Obvious Based on Igarashi and Pilcher.....	41
1.	Dependent Claim 12: The optoelectronic device as claimed in claim 11, wherein the encapsulation comprises a thin-film encapsulation.	41
C.	Ground III: Claim 14 Is Obvious Based on Igarashi and Dresevic.....	43
1.	Dependent Claim 14	43
D.	Ground IV: Claims 1–5, 8–10, and 13 Are Obvious Based on Shiotani.....	47
1.	Independent Claim 1	47
2.	Dependent Claim 2: The optoelectronic device as claimed in claim 1, wherein the first wavelength spectrum comprises a blue wavelength range and the second wavelength spectrum comprises a yellow wavelength range.	59
3.	Dependent Claim 3: The optoelectronic device as claimed in claim 1, wherein the optoelectronic device has a non-yellow color impression.....	62
4.	Dependent Claim 4: The optoelectronic device as claimed in claim 1, wherein the filter layer is configured to convert the electromagnetic radiation having the third wavelength spectrum into an electromagnetic radiation from a non-visible wavelength range.....	64
5.	Dependent Claim 5: The optoelectronic device as claimed in claim 4, wherein the filter layer is further configured to absorb the electromagnetic radiation having the third wavelength spectrum.	65
6.	Dependent Claim 8.....	66
7.	Dependent Claim 9: The optoelectronic device as claimed in claim 8, wherein the second filter layer is configured at least partially to absorb the electromagnetic radiation having the fourth wavelength spectrum.	68

8.	Dependent Claim 10: The optoelectronic device as claimed in claim 8, wherein the second filter layer is configured at least partially to reflect the electromagnetic radiation having the fourth wavelength spectrum.	69
9.	Dependent Claim 13: The optoelectronic device as claimed in claim 1, wherein the electromagnetic radiation which is emitted by the optoelectronic device corresponds to a superimposition of the electromagnetic radiation having the first wavelength spectrum and the electromagnetic radiation having the second wavelength spectrum.	71
E.	Ground V: Claims 11 and 12 Are Obvious Based on Shiotani and Pilcher	72
1.	Dependent Claim 11: The optoelectronic device as claimed in claim 1, further comprising an encapsulation one of disposed upstream and disposed downstream of the structured layer in the beam path of the electromagnetic radiation emitted by the organic layer sequence.	72
2.	Dependent Claim 12	75
F.	Ground VI: Claim 14 Is Obvious Based on Shiotani and Dresevic.....	76
1.	Dependent Claim 14	76
IX.	DISCRETIONARY DENIAL IS INAPPROPRIATE UNDER <i>FINTIV</i>	79
X.	CONCLUSION.....	80

TABLE OF EXHIBITS

Exhibit No.	Description
1001	U.S. Patent No. 8,314,547
1002	Certified File History for U.S. Patent No. 8,314,547
1003	Declaration of Dr. Gary Eden
1004	U.S. Patent Application Publication No. 2007/0023734 (Igarashi)
1005	Certified Translation of Japanese Published Application No. H10-170918 (Shiotani)
1006	U.S. Patent No. 6,949,389 (Pilcher)
1007	U.S. Patent No. 6,624,828 (Dresevic)
1008	U.S. Patent No. 2005/0189857 (Kobori)
1009	Warren J. Smith, <i>Modern Optical Engineering</i> (3d ed. 2000)
1010	Hongxia Li et al., <i>Zinc Oxide Films Prepared by Sol-Gel Method</i> , 275(1) J. Crystal Growth e943–e946 (2005)
1011	Japanese Published Application No. H10-170918 (Shiotani)
1012	Ho-Chi Huang et al., <i>Processes, Characterizations, and System Applications of Color-filter Liquid-crystal-on-silicon Microdisplays</i> , 14(5) J. SID 499–508 (2006)
1013	U.S. Patent Application Publication No. 2006/0152150 (Boerner)
1014	Eugene Hecht, <i>Optics</i> , Chapters 3 and 4 (4th ed. 2002)
1015	Safer Mourad, <i>Color Predicting Model For Electrophotographic Prints On Common Office Paper</i> , Thesis No.2708 (2003)
1016	U.S. Patent No. 6,897,876 (Murdoch)
1017	McGraw-Hill Dictionary of Scientific and Technical Terms (5th ed. 1994) (McGraw-Hill)
1018	Zhuohao Xiao et al., <i>Materials Development and Potential Applications of Transparent Ceramics: A Review</i> , Material Sci. & Eng'g R. 139 (2020)
1019	U.S. Patent Application Publication No. 2007/0159061 (Krummacher)
1020	A.P. Ghosh, <i>Full-Color OLED on Silicon Microdisplay</i> , 4464(1) Proc. SPIE 1–10 (2002)

Petition for *Inter Partes* Review of U.S. Patent No. 8,314,547

Exhibit No.	Description
1021	Celine Chartier et al., <i>Photoluminescence of Eu²⁺ in SrGa₂S₄</i> , 111(3) J. Luminescence 147–58 (2005)
1022	Pochi Yeh & Claire Gu, <i>Optics of Liquid Crystal Displays</i> (2009)
1023	U.S. Patent No. 7,193,364 (Klausmann)
1024	U.S. Patent No. 7,402,951 (Cok)
1025	Wolfgang Kowalsky et al., <i>OLED Matrix Displays: Technology and Fundamentals</i> , 442(1) Thin Solid Films 20–28 (2001)
1026	U.S. Patent No. 7,489,073
1027	Reflection and Refraction, Encyclopedia Britannica, https://www.britannica.com/science/light/Reflection-and-refraction (last visited Apr. 28, 2024)
1028	Sapphire, ESCO Optics, https://escooptics.com/pages/sapphire (last visited March 4, 2024)
1029	Docket Control Order, <i>Pictiva Displays International Ltd. v. Samsung Electronics Co., Ltd., et al.</i> , Case No. 2:23-cv-00495, Dkt. #40 (E.D. Tex. Apr. 17, 2024)

I. INTRODUCTION

Samsung Display Co., Ltd. (“Petitioner”) petitions for *inter partes* review (“IPR”) seeking cancellation of claims 1–5 and 8–14 (the “Challenged Claims”) of U.S. Patent No. 8,314,547 (Ex. 1001, “the ’547 patent”), assigned to Pictiva Displays International Ltd.

II. STANDING, MANDATORY NOTICES AND FEE AUTHORIZATION

Grounds for Standing: Pursuant to 37 C.F.R. § 42.104(a), Petitioner certifies that the ’547 patent is available for IPR and that Petitioner is not barred or estopped from requesting an IPR challenging the ’547 patent on the grounds identified in this petition.

Real Party-in-Interest: Petitioner identifies Samsung Display Co., Ltd., Samsung Electronics Co., Ltd., and Samsung Electronics America, Inc. as real parties-in-interest.

Related Matters: Patent Owner has asserted the ’547 patent in litigation against Samsung Electronics Co., Ltd. and Samsung Electronics America, Inc. in *Pictiva Displays International Ltd. v. Samsung Electronics Co., Ltd.*, Case No. 2:23-cv-00495 (E.D. Tex.).

Lead and Back-Up Counsel: Petitioner designates David A. Garr (Reg. No. 74,932, dgarr@cov.com) as lead counsel, of Covington & Burling LLP, One

Petition for *Inter Partes* Review of U.S. Patent No. 8,314,547

CityCenter, 850 Tenth Street, NW, Washington, DC 20001 (postal and hand delivery), telephone: (202) 662-6000, facsimile: (202) 662-6291.

Petitioner designates Scott C. Weidenfeller (Reg. No. 54,531) as back-up counsel, of Covington & Burling LLP, One CityCenter, 850 Tenth Street, NW, Washington, DC 20001 (postal and hand delivery), telephone: (202) 662-6000, facsimile: (202) 662-6291.

Service Information: Service information is provided in the designation of counsel above. Petitioner consents to service of all documents via electronic mail at SDC-Pictiva-IPR@cov.com.

Fee Authorization: The Office is authorized to charge all fees due in connection with this proceeding to Deposit Account No. 60-3160.

III. SUMMARY OF CHALLENGE

Petitioner requests IPR of claims 1–5 and 8–14 of the '547 patent based on the following grounds:

- ***Ground I:*** Claims 1–5, 8–11, and 13 are obvious over Igarashi;
- ***Ground II:*** Claim 12 is obvious over Igarashi and Pilcher;
- ***Ground III:*** Claim 14 is obvious over Igarashi and Dresevic;
- ***Ground IV:*** Claims 1–5, 8–10, and 13 are obvious over Shiotani;
- ***Ground V:*** Claims 11 and 12 are obvious over Shiotani and Pilcher;
- ***Ground VI:*** Claim 14 is obvious over Shiotani and Dresevic.

Petition for *Inter Partes* Review of U.S. Patent No. 8,314,547

The '547 patent issued based on an international application filed on August 4, 2008 and claims priority to a foreign application filed on September 19, 2007. Petitioner's challenge is based on the following references, which are available as prior art under 35 U.S.C. § 102 (pre-AIA)¹ as shown in the following table:

Exhibit	Reference	Date(s)	Availability as Prior Art
Ex. 1004 (Igarashi)	U.S. Patent Application Publication No. 2007/0023734	Filed July 27, 2006 Published Feb. 1, 2007	§§ 102(a), 102(b), 102(e)
Ex. 1011 (Shiotani)	Japanese Published Application No. H10-170918 (certified translation provided as Ex. 1005)	Published June 26, 1998	§§ 102(a), 102(b)
Ex. 1006 (Pilcher)	U.S. Patent No. 6,949,389	Filed May 2, 2002 Issued Sep. 27, 2005	§§ 102(a), 102(b), 102(e)
Ex. 1007 (Dresevic)	U.S. Patent No. 6,624,828	Filed July 30, 1999 Issued Sep. 23, 2003	§§ 102(a), 102(b), 102(e)

None of these references were considered by the Examiner during prosecution of the '547 patent. The supporting declaration of J. Gary Eden, Ph.D. (Ex. 1003) was also not before the Examiner. Accordingly, the prior art and arguments in this

¹ Because the application for the '547 patent was filed prior to March 16, 2013, the pre-AIA conditions for patentability apply.

Petition are not the same, or substantially the same, as those previously presented to the Office under 35 U.S.C. § 325(d).

IV. OVERVIEW OF THE '547 PATENT

The '547 patent is directed to an optoelectronic device suitable for “illumination devices” or “a component of a flashlight.” '547 patent, 14:31–36. The patent states that its “invention relates to an optoelectronic device which [1] can emit electromagnetic radiation during operation and [2] has a desired color impression in the switched-off state.” '547 patent, 1:13–15.

In discussing light-emitting devices that include “blue OLEDs [organic light-emitting diodes] and a phosphor conversion substance,” the '547 patent states that the device can have a “yellowish color impression,” *id.*, 9:1–12, that is “undesired for esthetic reasons,” *id.*, 4:3–13. A stated object of the patent is “to provide an optoelectronic device comprising a wavelength conversion layer, which device can reduce or avoid an undesired color impression in a switched-off state.” *Id.*, 1:19–22.

As shown in Figure 1A, for example, “the optoelectronic device has an organic layer sequence 1...embodied as an OLED,” with an “active region...[which] is suitable for emitting electromagnetic radiation 15 having a first wavelength spectrum” that can “comprise a blue wavelength range.” '547 patent, 10:5–12, 10:58–60. It further includes a “structured layer comprising a first region 2A and a second region 2B.” *Id.*, 10:13–14. The first region has a “wavelength conversion

layer 3,” *id.*, 10:16, which emits a wavelength spectrum that “comprises a yellow wavelength range,” *id.*, 11:40–41. The second region has a “filter layer 4,” *id.*, 1:20, 1:34, which is “transmissive to blue light...while it is opaque to electromagnetic radiation having a yellow wavelength range and a red and green wavelength range,” *id.*, 11:43–47.

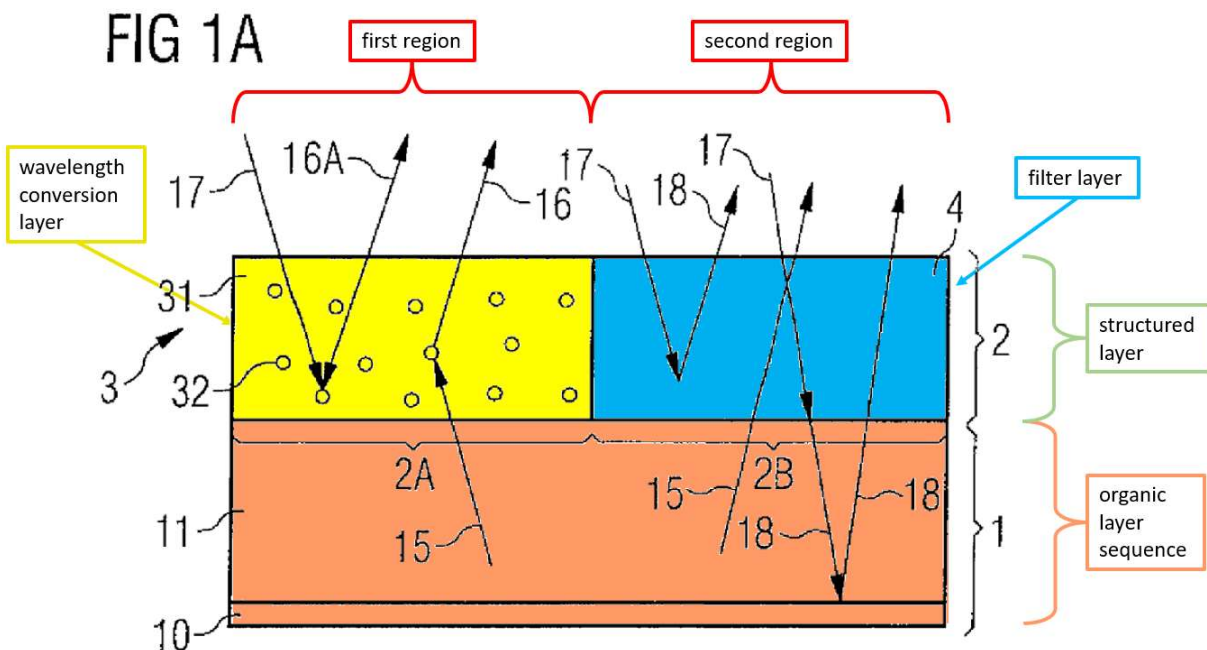

'547 patent, Fig. 1A (annotated).

The '547 patent states that when the device operates (i.e., when it is on), it emits “whitish” radiation. '547 patent, 11:14–15. To accomplish this, the organic layer sequence emits “electromagnetic radiation 15 having a first wavelength spectrum” (e.g., blue). In the first region, this radiation 15 is converted by the wavelength conversion layer “at least partially...into electromagnetic radiation 16

having a second wavelength spectrum” (e.g., yellow). *Id.*, 10:22–25. In the second region, the radiation 15 “can pass through the filter layer 4 in an unimpeded manner and substantially without any alteration of its spectral components.” *Id.*, 10:38–40. According to the patent, “this results in an electromagnetic radiation from a yellow wavelength range combined with an electromagnetic radiation from a blue wavelength range, which results in a desired, for example whitish, emission characteristic.” *Id.*, 11:13–16.

In the switched-off state, the device likewise provides a “whitish” color impression:

[I]n the wavelength conversion layer, [incident] electromagnetic radiation 17 is converted into electromagnetic radiation 16A, and in the filter layer 4 the incident electromagnetic radiation 17 is filtered, resulting in the filtered electromagnetic radiation 18. Consequently, *once again through combination of a yellowish portion of the electromagnetic radiation 16A and a bluish portion of the electromagnetic radiation 18, a non-yellowish, preferably whitish, color impression arises* for an observer of the optoelectronic device in the switched-off state thereof.

’547 patent, 11:20–29.²

² All emphasis added except where otherwise noted.

The '547 patent includes one independent claim (claim 1) and thirteen dependent claims (claims 2–14).

A. Prosecution History

Prosecution claims 1 and 3–15 were rejected as anticipated and/or obvious in view of Kobori (US 2005/0189857) (Ex. 1008) and/or Krummacher (US 2007/0159061) (Ex. 1019).

Whereas the '547 patent's embodiments relate to a “whitish emission” device for flashlights or other illumination devices, Kobori is directed to a color display comprising red, green, and blue pixels. Nonetheless, the Examiner determined that Kobori's display satisfied all elements of prosecution claim 1 (among others), including the claimed organic layer sequence which emits an electromagnetic radiation having a first wavelength spectrum during operation (organic light-emitting device 10M), a structured layer with first and second regions (22 and 23), a wavelength conversion layer (green fluorescence conversion layer 23) and a filter layer (red color filter layer 22R). Ex. 1002 (File History) at 508–509. These elements are depicted in Kobori's Figure 1:

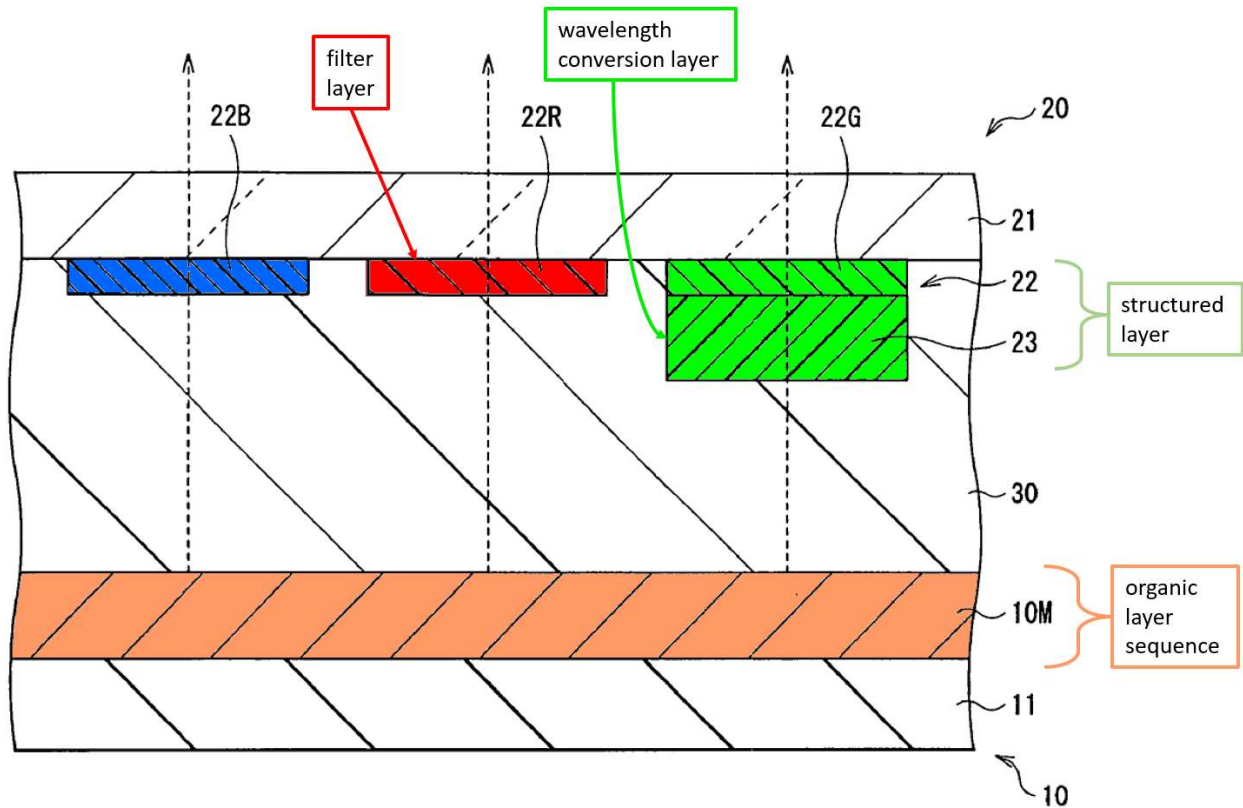

Kobori, Fig. 1 (annotated).

However, the Examiner found that prosecution claim 2 contained allowable subject matter. Ex. 1002 (File History) at 513. Prosecution claim 2 was a dependent claim that added the element “wherein the filter layer is transparent to the electromagnetic radiation having the first wavelength spectrum.” *Id.* at 576. The Examiner did not find this element present in Kobori, presumably because its red color filter 22R (“filter layer”) is not transparent to the entire emission spectrum of its organic light-emitting device 10M (“first wavelength spectrum”). That is, Kobori’s display uses an “organic light emitting device 10M of *multicolor* light emission for emitting *blue, red, and green* light, or of white light emission.” Kobori,

¶[0033]. A red color filter would not be transparent to the blue or green components of such multicolor (or white) light. Hence, Kobori’s filter layer is not “transparent to the electromagnetic radiation having the first wavelength spectrum.”

The applicants did not dispute the Examiner’s findings on Kobori (or Krummacher). Rather, the applicants amended prosecution claim 1 “to incorporate the subject matter of dependent claim 2 (now cancelled).” Ex. 1002 at 565 (further including “amendments to claims 5-13 [that] correct minor claim wording, and are cosmetic in nature”). Following this amendment, the claims were allowed.

Thus, the claims of the ’547 patent were only allowed after claim 1 (the only independent claim) was amended to require that “the filter layer is transparent to the electromagnetic radiation having the first wavelength spectrum.” Ex. 1002 at 576. Although the Examiner found that “the references of the Prior Art of record failed to teach or suggest” claim 1 with that requirement, the Examiner did not have the benefit of other prior art, including the Igarashi and Shiotani references, which were not of record during prosecution and which specifically disclose such a filter layer, along with every other element of claim 1 (among others), as discussed below.

V. LEVEL OF ORDINARY SKILL

A person of ordinary skill in the art (“POSITA”) at the time of the alleged invention of the ’547 patent would have a bachelor’s degree in electrical engineering, physics, or a comparable field of study, and at least three years of

research or industrial experience with semiconductor (organic or inorganic) optoelectronic devices and/or lighting or displays. Ex. 1003, ¶53. An individual with additional education could have less research or industrial experience and vice versa.

Id.

VI. CLAIM CONSTRUCTION

Petitioner does not believe any specialized constructions are necessary for this petition.

VII. OVERVIEW OF PRIOR ART

A. Igarashi (Ex. 1004)

Igarashi, which serves as the primary reference for grounds I–III, “relates to a phosphor, an optical device including the phosphor, and a display device including the phosphor.” Igarashi, ¶[0002]. Figure 5 of Igarashi illustrates an embodiment of such a display device:

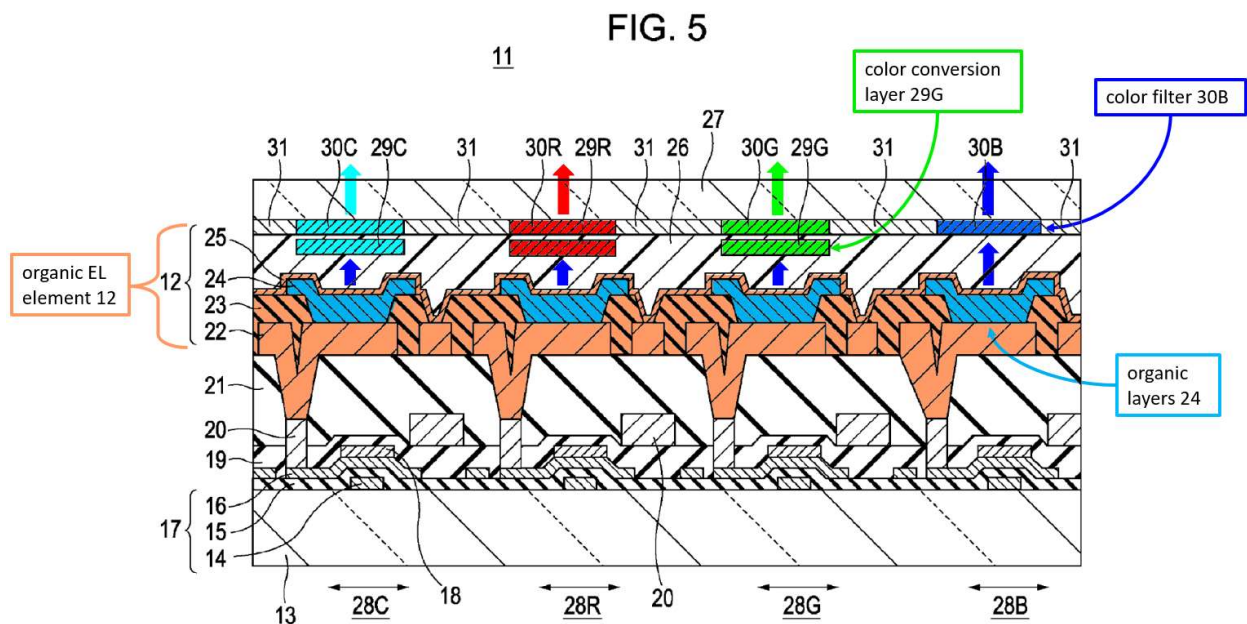

Igarashi, Fig. 5 (annotated). The display includes cyan, red, green, and blue pixels (28C, 28R, 28G, and 28B). It further “includes an organic electroluminescent (EL) element 12” having at least an anode (22), organic layers (24), and a cathode (25). Igarashi, ¶¶[0087–88].

The organic electroluminescent element emits “light in the blue region having a wavelength of 450 to 470 nm.” *Id.*, ¶[0088]. For the cyan, red, and green pixels, the device includes “[c]olor conversion layers corresponding to a target color for each pixel.” *Id.*, ¶[0089]. These layers absorb the blue light emitted by electroluminescent element 12 and emit light of the target color. For the blue pixels, “no color conversion layer is provided.” *Id.*, ¶[0089].

Each pixel may also include a “color filter,” identified as 30R, 30G, 30B, and 30C in Figure 5. Igarashi, ¶[0089]. “A black matrix 31 that at least optically separates the color filters is provided between the color filters.” *Id.*

B. Shiotani (Ex. 1005)

Shiotani, which serves as the primary reference for grounds IV–VI, “relates to a liquid crystal display device provided with a color conversion layer capable of color display, which can be used for both reflective and transmissive applications.” Shiotani, ¶[0001]. Figure 7 of Shiotani illustrates an embodiment of such a display device:

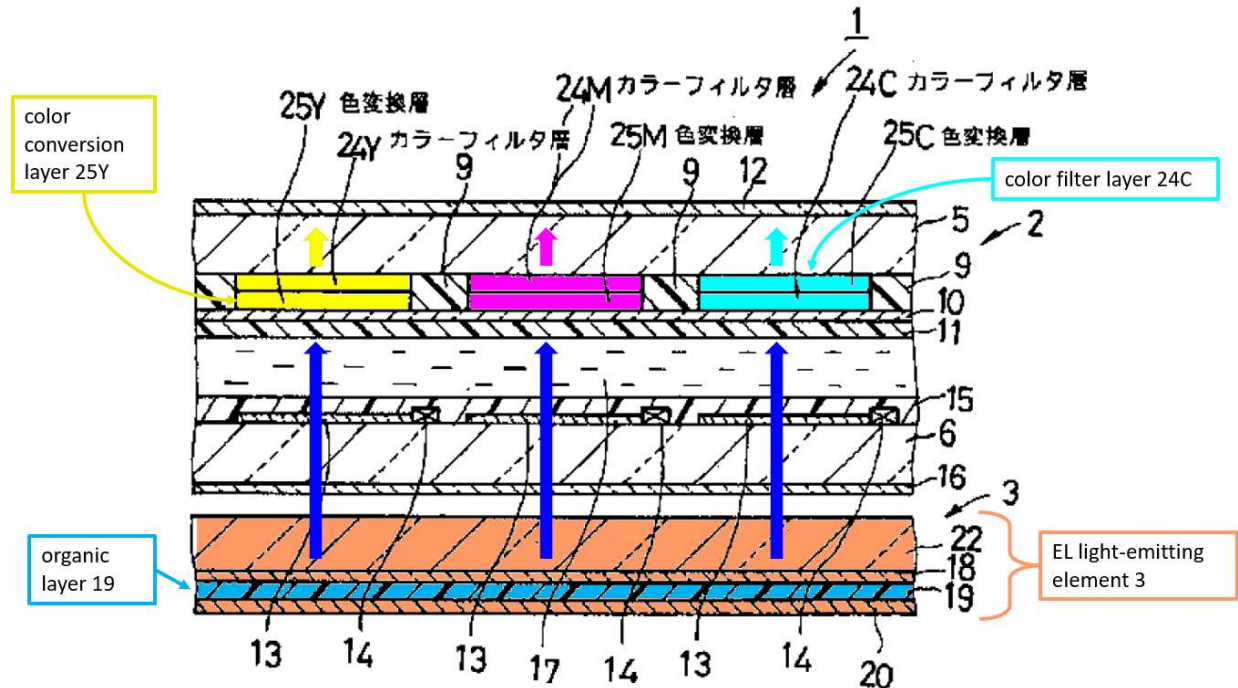

Shiotani, Fig. 7 (annotated).

When Shiotani’s display is used as a transmissive device, its “EL light-emitting element 3 is used as the backlight.” Shiotani, ¶[0028].³ EL light-emitting element 3 is an OLED “formed by sequentially laminating a front electrode 18 made of transparent ITO, an organic EL light-emitting layer 19, and a light-reflective rear electrode 20 across the entire display region on the rear surface of an EL substrate 22 made of transparent glass.” *Id.*, ¶[0021]. The organic EL material “generates blue

³ Shiotani discloses that the same device can also be used in reflective applications, in which light emitting element 3 is turned off and the display operates by reflecting ambient light. *See* Shiotani ¶[0001]. However, this petition focuses on the display’s transmissive applications.

light when a predetermined voltage is applied between the front and rear electrodes 18 and 20.” *Id.*, ¶[0022].

The light from EL light-emitting element 3 is transmitted through “liquid crystal cell 2.” Shiotani, ¶[0018]. In the embodiment of Figure 7, the pixels are configured to emit yellow, magenta, and cyan light. *Id.*, ¶[0040]. Each pixel includes a “color conversion layer” that absorbs the blue light emitted by the OLED and emits light of the desired color. *Id.* Each pixel further comprises a “color filter layer.” Shiotani, ¶[0040]. As shown in Figure 7, these color filter layers are arranged downstream from the color conversion layers.

C. Pilcher (Ex. 1006)

Pilcher relates to encapsulation of OLED devices. “Encapsulation is a way to protect the OLED device from the damaging environmental effects—primarily from oxygen and moisture.” Pilcher, 1:8–10. Pilcher explains that it was “well known in the art to encapsulate an OLED display by physically mating a top glass (or other suitable material) over, but usually not touching, the OLED device with an epoxy border.” *Id.*, 1:10–13. But it was further known that there was “a cheaper and better manner of encapsulation, called ‘direct thin-film’ encapsulation.” *Id.*, 1:18–19. In thin-film encapsulation, also called “polymer multi-layer” or “PML” encapsulation, “alternating and repeating layers of an organic...and a barrier layer” are deposited over the OLED structures. *Id.*, 1:20–23.

D. Dresevic (Ex. 1007)

Dresevic describes a common pixel arrangement used in flat panel displays, teaching that each pixel typically comprises three or more colored elements arranged in stripes:

In displays commonly used for computer applications, each pixel on a color LCD display usually comprises three non-square elements, i.e., red, green and blue (RGB) pixel sub-components.... LCD displays of this type comprise a series of *RGB pixel sub-components which are commonly arranged to form stripes along the display*. The RGB stripes normally run the entire length of the display in one direction.

Dresevic, 2:3–13. Figure 1 of Dresevic illustrates this stripe arrangement

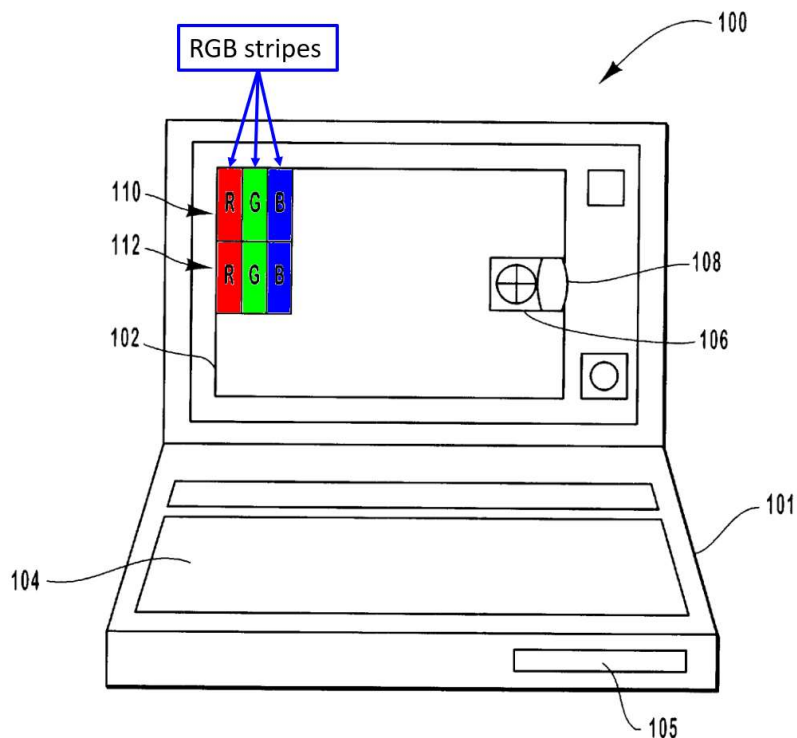

Dresevic, Fig. 1 (annotated).

VIII. APPLICATION OF PRIOR ART TO THE CHALLENGED CLAIMS

A. Ground I: 1–5, 8–11, and 13 Are Obvious Based on Igarashi

Igarashi discloses a display device, illustrated in Figure 5, that teaches or suggests all elements of claims 1–5, 8–11, 13 of the '547 patent, as discussed below:

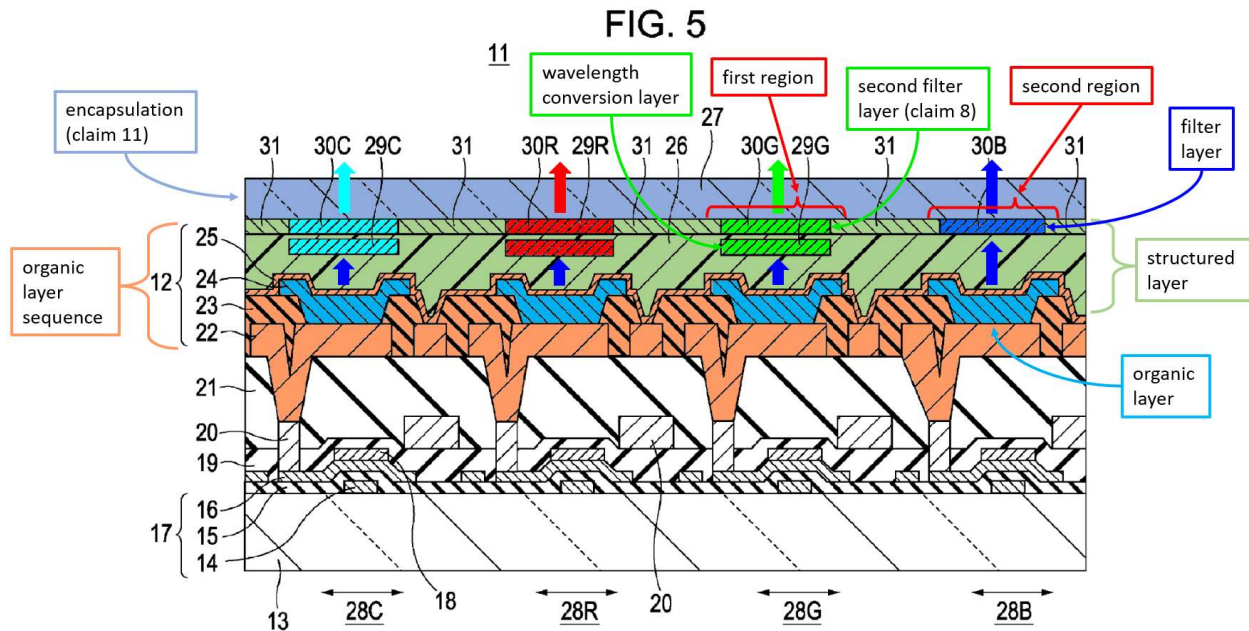

Igarashi, Fig. 5 (annotated).

1. Independent Claim 1

a. Preamble: An optoelectronic device, comprising:

To the extent the preamble is limiting, Igarashi discloses it. Igarashi discloses a “display device...includ[ing] an organic electroluminescent (EL) element,” Igarashi, ¶[0087], which is “driven by an active matrix,” *id.*, ¶[0112]. As an electronic device that emits light, it is an optoelectronic device. Ex. 1003, ¶¶67–71.

- b. **Element 1[a]: an organic layer sequence which emits an electromagnetic radiation having a first wavelength spectrum during operation; and**

Igarashi discloses this element. Igarashi's display device includes an "organic electroluminescent element 12" as shown in Figure 5:

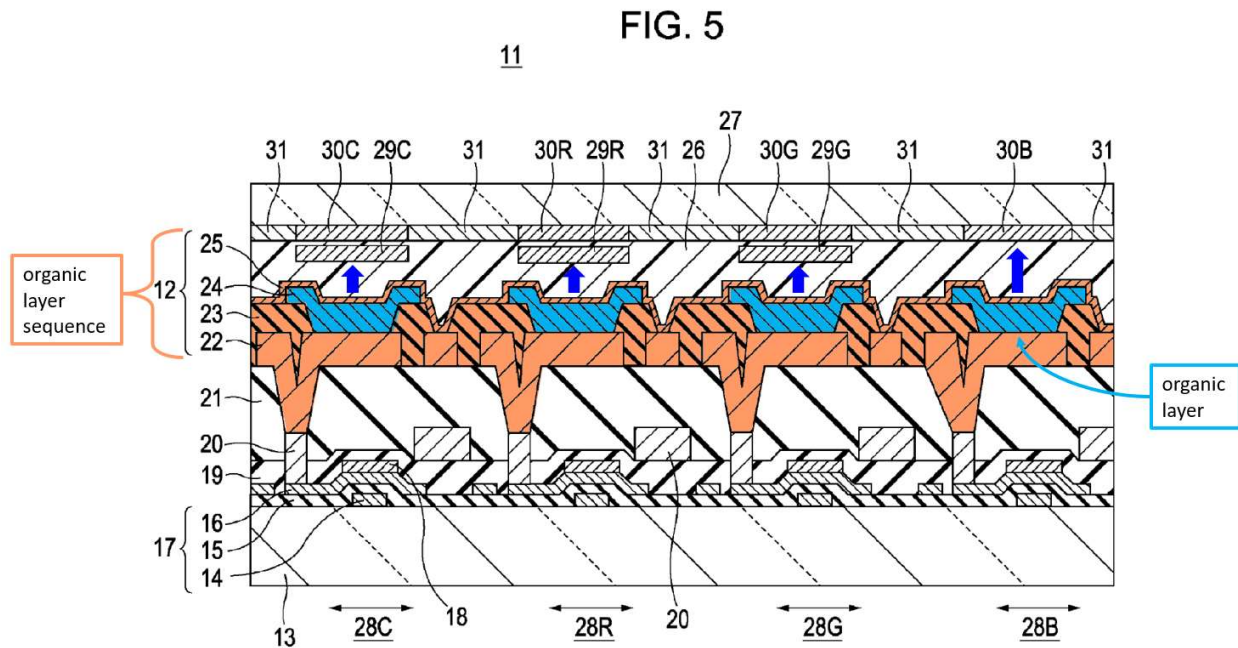

Igarashi, Fig. 5 (annotated), ¶[0087].

Organic electroluminescent element 12 comprises an "organic layer sequence" as that term is used in the '547 patent. Ex. 1003, ¶72. The '547 patent states that "the organic layer sequence can be embodied in particular as an organic light-emitting diode (OLED)," explaining that such "an OLED can have an *organic layer or a layer sequence comprising at least one organic layer*, having an active region that can emit electromagnetic radiation during operation." '547 patent, 4:33–38. Similarly, Igarashi's organic electroluminescent element 12 includes an "organic

layer 24 composed of an organic luminescent material,” Igarashi, ¶[0088], which is formed from multiple layers that “are sequentially formed on the surface of first electrode 22,” *Id.*, ¶[0107] (explaining the constituent organic layers include “a hole-injecting layer,” “a hole transport layer, a blue light emitting layer,” “an electron transport layer,” and “an electron-injecting layer”).

The ’547 patent further depicts its “organic layer sequence 1” as including “electrode 10,” *see* ’547 patent, figs. 1A–B, 10:5–12, and states the “OLED can have a first electrode and a second electrode, wherein the organic layer or the layer sequence comprising at least one organic layer ... can be arranged between the first and second electrodes,” *id.*, 4:38–42. To the extent the “organic layer sequence” limitation requires such electrodes, Igarashi’s organic electroluminescent element 12 similarly includes a “first electrode 22” and a “second electrode 25,” with “organic layer 24” disposed between them. Igarashi, ¶¶[0087]–[0088].

Finally, Igarashi discloses that “light in the blue region having a wavelength of 450 to 470 nm is emitted” by the organic layer 24. *Id.*, ¶[0088]. Such blue light is electromagnetic radiation having a first wavelength spectrum. Thus, Igarashi discloses an “organic layer sequence which emits an electromagnetic radiation having a first wavelength spectrum.” Ex. 1003, ¶¶72–78.

- c. **Element 1[b]: a structured layer disposed downstream of the organic layer sequence in a beam path of the electromagnetic radiation emitted by the organic layer sequence and including first and second regions;**

Igarashi discloses this element. As shown below, Igarashi’s display includes a “structured layer” comprising (i) “[a] resin layer 26”; (ii) “color conversion layers 29R, 29G, and 29C” that “correspond[] to a target color for each pixel”; (iii) “color filters 30R, 30G, 30B, and 30C for corresponding pixels”; and (iv) “[a] black matrix 31...between the color filters.” Igarashi, ¶[0089]; Ex. 1003, ¶¶79–81.

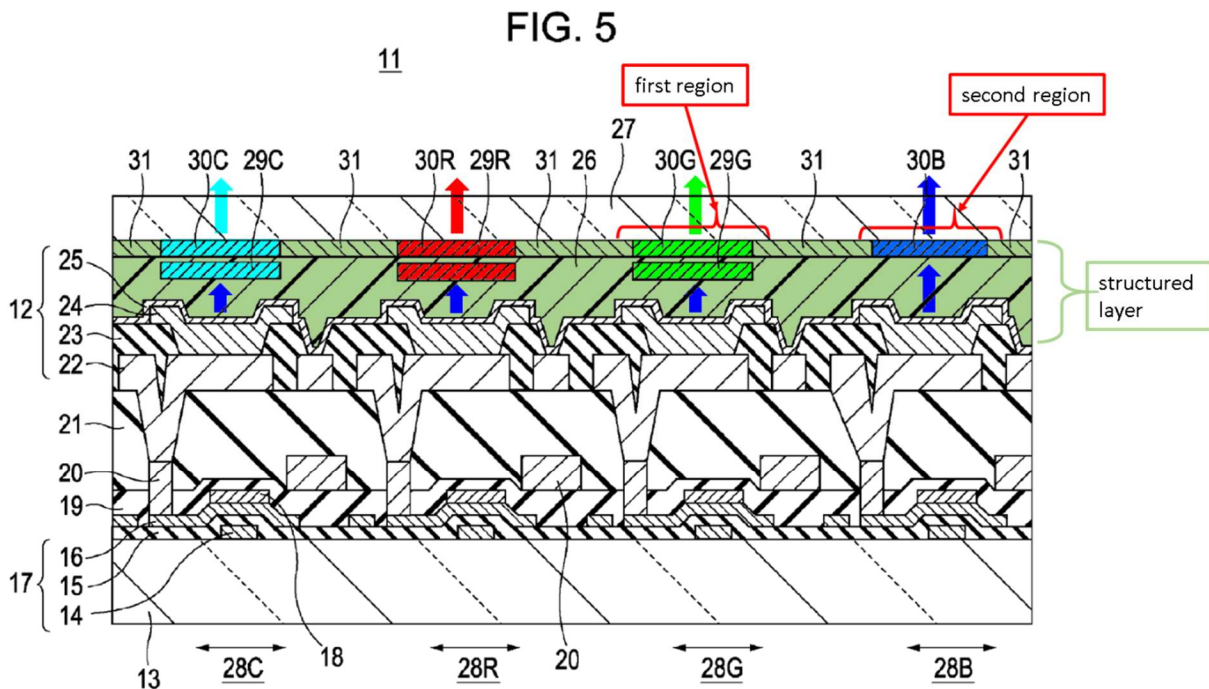

Igarashi, Fig. 5 (annotated).

Igarashi’s structured layer includes first regions (corresponding to green pixels 28G) and second regions (corresponding to blue pixels 28B), as annotated above. Ex. 1003, ¶[82]. This structured layer is disposed downstream of the organic

layer sequence in a beam path of the electromagnetic radiation emitted by the organic layer sequence. Igarashi's "organic EL element [12] has a top emission structure," Igarashi, ¶[0112], and thus emits electromagnetic radiation in an upward direction through the structured layer's color conversion layers and color filters. Ex. 1003, ¶84.

While Figure 5 shows only one pixel of each color, Igarashi discloses an "active matrix" display device, Igarashi, ¶[0112], which a POSITA would understand to include a plurality of pixels of each color, arranged in columns and rows (i.e., as a "matrix"). Ex. 1003, ¶83. Thus, to the extent that the claim requires more than one "first regions" or "second regions," Igarashi's structured layer includes a plurality of "first regions" (one for each green pixel) and a plurality of "second regions" (one for each blue pixel). *Id.*

- d. Element 1[c]: wherein the first regions each include a wavelength conversion layer configured to convert at least partially electromagnetic radiation having a first wavelength spectrum into an electromagnetic radiation having a second wavelength spectrum;**

Igarashi discloses this element. As shown in Figure 5 below, each of the first regions of Igarashi's structured layer includes a color conversion layer 29G. *See* Igarashi, ¶[0089]; Ex. 1003, ¶¶86–90.

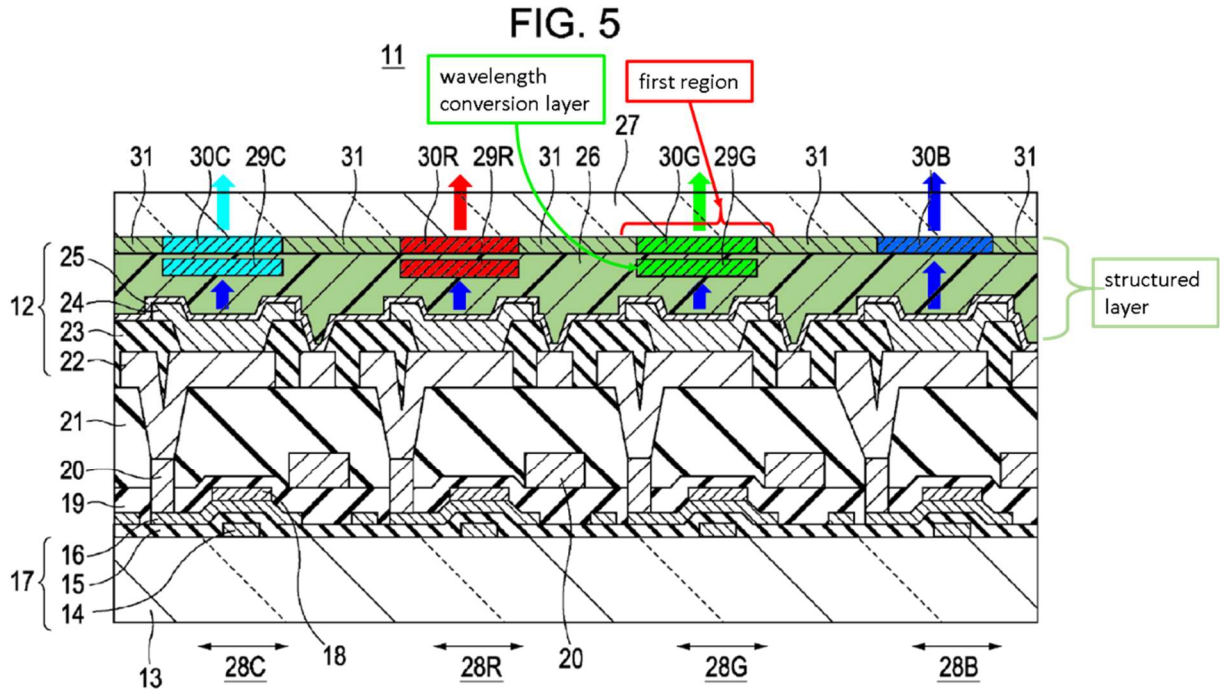

Id., Fig. 5 (annotated).

As Igarashi explains, “the color conversion layer 29G corresponding to green includes the phosphor according to an embodiment of the present invention.” Igarashi, ¶[0090]. The phosphor converts the blue light emitted by the organic layer of organic electroluminescent element 12 (i.e., electromagnetic radiation having a first wavelength spectrum) into “green output light in the pixel 28G” (i.e., electromagnetic radiation having a second wavelength spectrum). *Id.*, ¶[0091]; Ex. 1003, ¶¶88–89. Color conversion layer 29G thus constitutes a “wavelength conversion layer” as specified in this element. *Id.*

- e. **Element 1[d]: wherein the second regions each include a filter layer which is at least partially opaque to an electromagnetic radiation having a third wavelength spectrum which corresponds to at least one part of the second wavelength spectrum;**

Igarashi discloses this element. As shown in Figure 5 below, each of the second regions of Igarashi’s structured layer includes “color filter 30B.” Igarashi, ¶¶0089; Ex. 1003, ¶¶91–95.

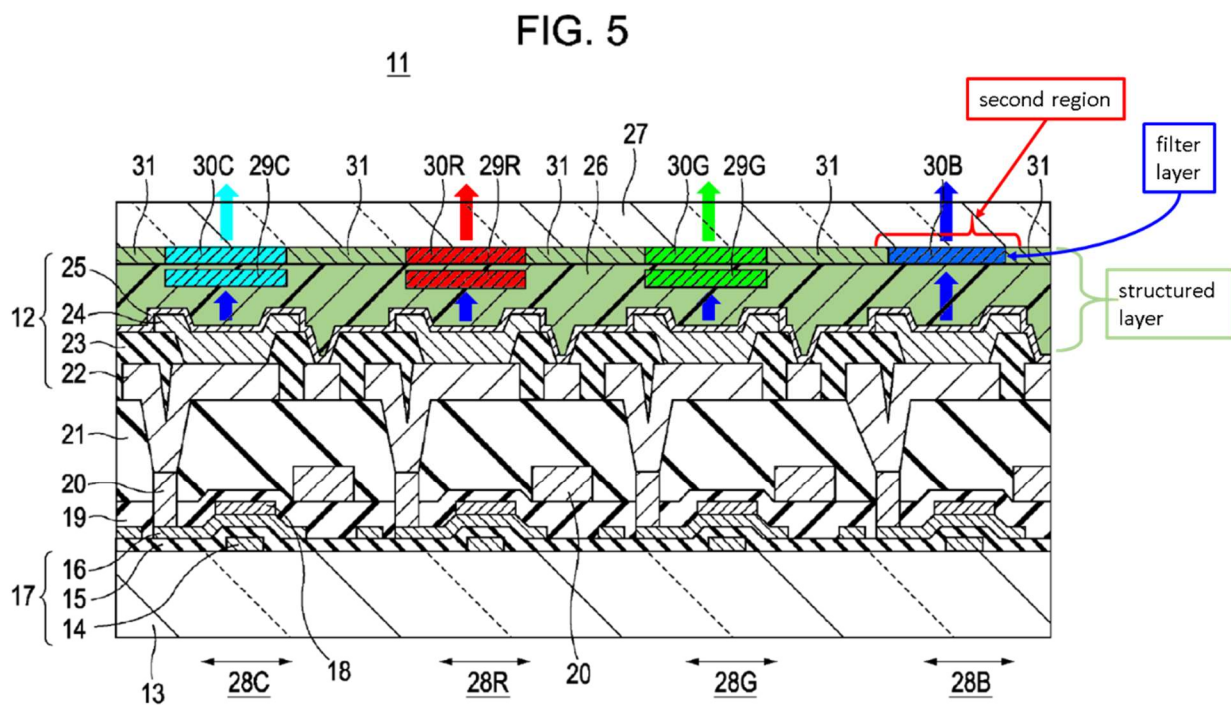

Id., Fig. 5 (annotated).

A POSITA would understand the color filter for the blue pixel transmits blue light while blocking light of other colors (including red and green light); this is how color filters “filter out” light to achieve the desired color. Ex. 1003, ¶93; *see, e.g.*, Ex. 1009 at 224 (explaining that “[a]bsorption filters are composed of materials

which transmit light selectively; that is, they transmit certain wavelengths more than others”); Shiotani, Abstract, ¶[0018] (explaining that a “color filter layer 7B for blue” serves to “transmit[] light in the blue wavelength region and absorb[] light in other wavelength regions when light containing light in the blue wavelength region is incident”). In particular, color filter 30B is at least partially opaque to green light. Ex. 1003, ¶¶93–94.

Igarashi’s color filter 30B therefore constitutes “a filter layer that is at least partially opaque to an electromagnetic radiation having a third wavelength spectrum” (green light) “which corresponds to at least one part of the second wavelength spectrum” (light emitted by the green color conversion layer 29G).

f. Element 1[e]: wherein the first and second regions of the structured layer are arranged laterally in a beam path of the optoelectronic device; and

Igarashi discloses this element. As shown in Figure 5 below, the first and second regions are arranged laterally (left to right) in a beam path of the optoelectronic device. Igarashi’s “organic EL element [12] has a top emission structure,” Igarashi, ¶[0112], and therefore emits electromagnetic radiation in an upward direction through the structured layer’s color conversion layers and color filters. Ex. 1003, ¶¶96–98.

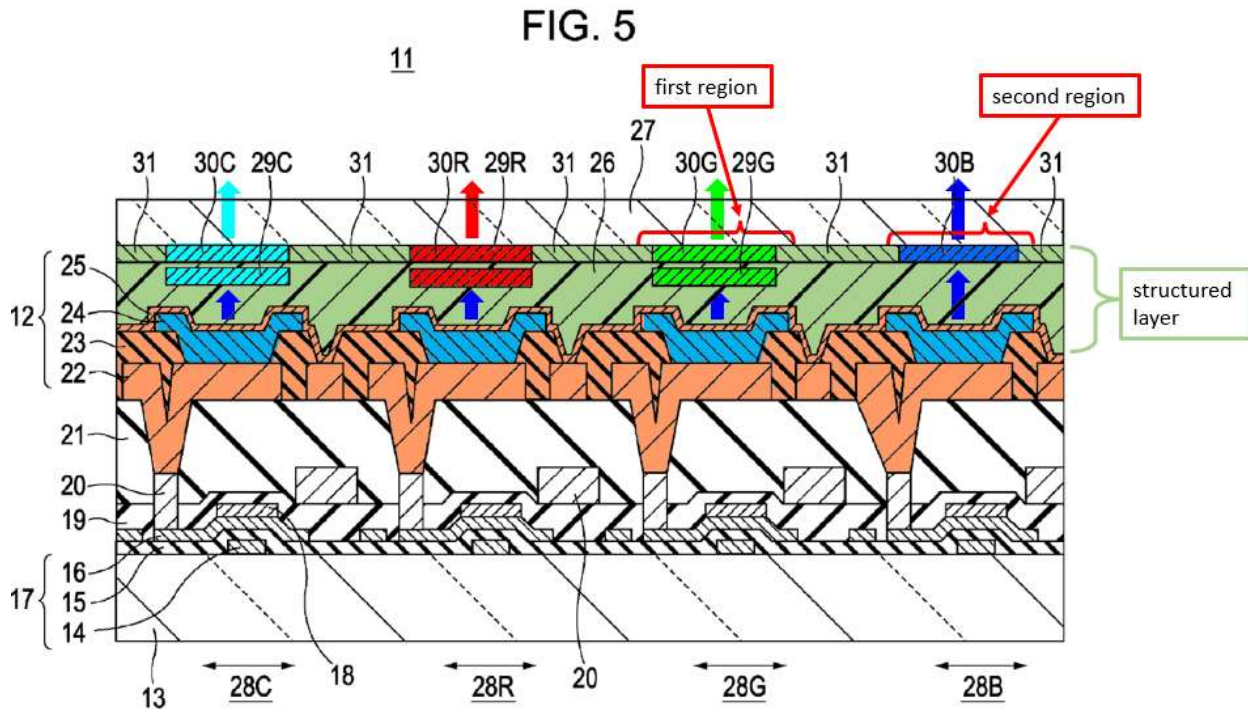

Id., Fig. 5 (annotated).

- g. Element 1[f]: wherein the filter layer is transparent to the electromagnetic radiation having the first wavelength spectrum.**

Igarashi discloses this element. A POSITA would understand that Igarashi's color filter 30B (the filter layer) is transparent to blue light (i.e., electromagnetic radiation having the first wavelength spectrum). Ex. 1003, ¶¶99–109.

As Dr. Eden explains, the term “transparent” describes materials with high optical transmittance. Ex. 1003, ¶101. A POSITA would understand that a color filter for a display allowed high optical transmittance of the corresponding color of light and thus was transparent to that color of light. *Id.*, ¶102; *see, e.g.*, Shiotani, Abstract, ¶[0018] (explaining that “color filter layer 7B for blue” serves to

“*transmit[] light in the blue wavelength region and absorb[] light in other wavelength regions*”). In particular, “[b]ecause color filter 30B is the color filter ‘in the pixel 28B corresponding to the blue light emission,’ a POSITA would understand that it is a *blue* color filter—i.e., a filter that transmits (and is transparent to) blue light.” Ex. 1003, ¶100.

At a minimum, to the extent there were any question whether Igarashi’s blue color filter 30B is transparent to blue light, it would have been obvious to use a transparent filter. Ex. 1003, ¶107. Color filters that are highly transmissive to blue light—and therefore “transparent” to such radiation—were well known in the art and routinely used in OLED displays. *Id.*, ¶¶103–05. Huang, for example, discloses a blue filter that transmits almost 90% (or more) of blue light. Ex. 1012; Ex. 1003, ¶104. Boerner describes a filter that “shows a high transparency in the blue region of the visible spectra” and transmits blue light “almost without losses.” Ex. 1013, ¶[0036]; Ex. 1003, ¶105. Such a filter “would allow more light to reach the viewer than a filter that is not transparent.” Ex. 1003, ¶108. A POSITA would have been motivated to use a transparent filter because the resulting display would be brighter, more energy efficient, and longer lasting. *Id.* As explained by Dr. Eden, if the filter were not transparent, it would be necessary to increase the current through the OLEDs, which would both consume more power and decrease the lifetime of the display. *Id.* A POSITA would have had a reasonable expectation of success in using

a transparent filter in Igarashi's display. Ex. 1003, ¶109. Such filters were commercially available and it would have been a routine matter to replace one color filter with another. *Id.* Thus, even if Igarashi had not disclosed element 1[f], it would have rendered it obvious.

2. Dependent Claim 2: The optoelectronic device as claimed in claim 1, wherein the first wavelength spectrum comprises a blue wavelength range and the second wavelength spectrum comprises a yellow wavelength range.

Igarashi teaches or suggests the elements of this claim. *First*, Igarashi discloses that “light in the blue region having a wavelength of 450 to 470 nm is emitted” by its electroluminescent element. Igarashi, ¶[0088]. Thus, “the first wavelength spectrum” (the spectrum of light emitted by Igarashi's organic layer sequence) “comprises a blue wavelength range.” Ex. 1003, ¶111.

Second, the light emitted by Igarashi's color conversion layer 29G (the “second wavelength spectrum”) includes light in a yellow wavelength range. “[T]he color conversion layer 29G corresponding to green includes the phosphor according to an embodiment of the present invention.” Igarashi, ¶[0090]. The phosphor is used to generate “green output light in the pixel 28G.” Igarashi, ¶[0091]. However, a POSITA would understand from Igarashi's disclosures that its output also comprises light in a yellow wavelength range. Ex. 1003, ¶¶112–16.

Igarashi discloses an improved thiogallate phosphor that can be used in color conversion layer 29G. Igarashi, ¶[0084]; Ex. 1003, ¶114–15. As shown in Figure 10

below, thiogallate phosphors have emission spectra that include a yellow wavelength range. Dr. Eden calculated that approximately 10% of the light in Figure 10 has a wavelength between 570 and 590 nm. Ex. 1003, ¶114. This percentage rises to 47% if the 540–570 nm yellow-green range is included. *Id.*

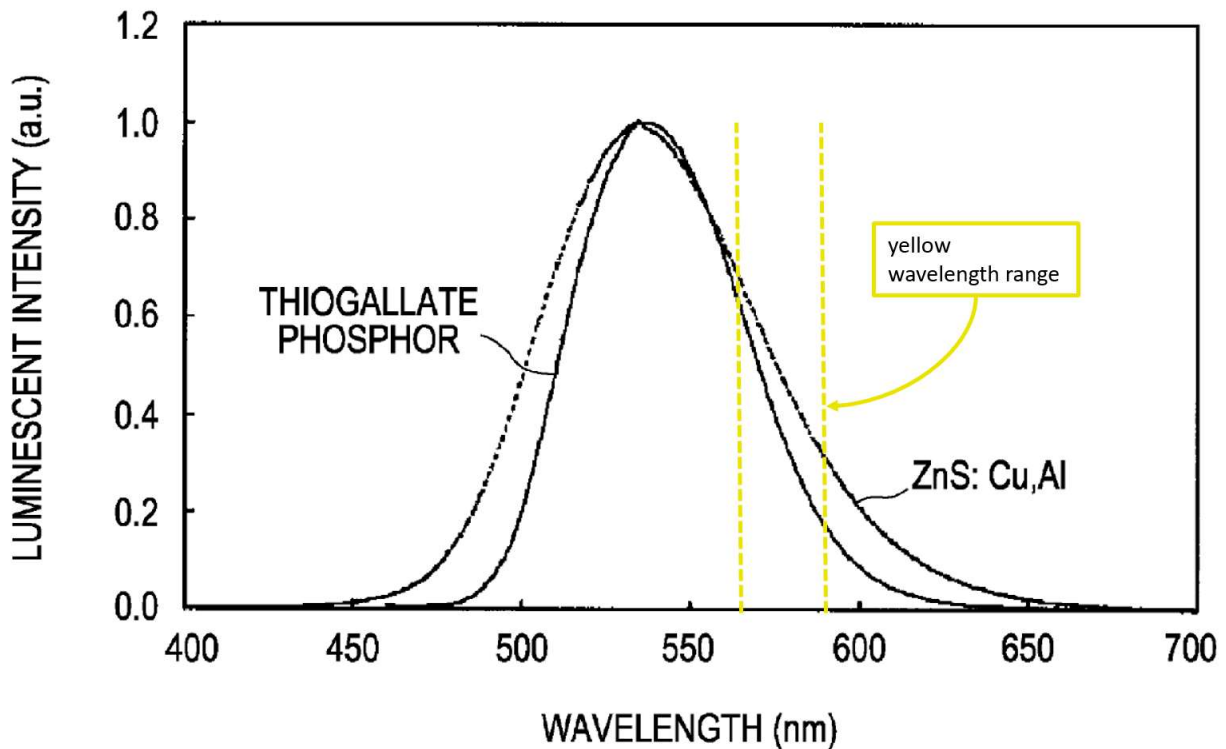

Igarashi, Fig. 10 (annotated).

Igarashi's improved phosphor differs from the thiogallate phosphor shown in Figure 10 only in the ratio of gallium to strontium. Ex. 1003, ¶115. As Dr. Eden explains, a POSITA would understand that this change would not eliminate the yellow light emitted by the phosphor. *Id.* In any event, Igarashi discloses embodiments ("Comparative Examples 1 to 3") in which the thiogallate phosphor of Figure 10 was used in color conversion layer 29G. Igarashi, ¶[0095]; Ex. 1003,

¶¶114–15. Therefore, in all of the embodiments, “the second wavelength spectrum” (light emitted by color conversion layer 29G) “comprises a yellow wavelength range.”⁴

At a minimum, it would have been obvious to use a phosphor in Igarashi’s display that emitted light in a yellow wavelength range. Igarashi discloses a variety of different green phosphors that were known in the art, including zinc sulfide (ZnS), Igarashi, ¶[0006], and conventional thiogallate phosphors “which had a known composition” and which Igarashi uses as “Comparative Examples,” *id.*, ¶[0056]. Each of these phosphors emits light having a wavelength spectrum that comprises a yellow wavelength range. *Id.*, Fig. 10; Ex. 1003, ¶¶114–15. A POSITA would have been motivated to use such conventional phosphors, which would eliminate time and expense associated with manufacturing a custom phosphor. Ex. 1003, ¶118. A

⁴ Independent claim 1 remains satisfied where the “second wavelength spectrum” (light output by green color conversion layer 29G) includes yellow as well as green light. In particular, Element 1[d] would remain satisfied. The “filter layer” (blue color filter 30B) is at least partially opaque to green light, which is a “third wavelength spectrum” that “corresponds to at least one part of the second wavelength spectrum” (the second wavelength spectrum including both yellow and green light).

POSITA would also have had a reasonable expectation of success in implementing a known, conventional phosphor in Igarashi. *Id.*, ¶119.

3. Dependent Claim 3: The optoelectronic device as claimed in claim 1, wherein the optoelectronic device has a non-yellow color impression.

Igarashi teaches or suggests the elements of this claim. A POSITA would understand that the claimed “non-yellow color impression” refers to the color impression when the device is in a “switched-off state.” Ex. 1003, ¶121. The ’547 patent repeatedly refers to the “color impression in the switched-off state.” *See, e.g.*, ’547 patent, 1:13–15, 1:19–22; 3:14–21; 3:40–45; 11:24–29; *see also* Ex. 1003, ¶121.

Igarashi’s display has a non-yellow color impression in the switched-off state. Ex. 1003, ¶¶122–23. The display includes red, green, blue, and cyan filters, each the size of a single pixel. A POSITA would understand that to the extent that light is reflected off of these filters, it would combine to produce a gray-white light. Ex. 1003, ¶122. Further, “[a] black matrix 31 that at least optically separates the color filters is provided between the color filters.” Igarashi, ¶[0089]. A substantial portion of the display is covered by the black matrix, which would darken the color impression of the display. Ex. 1003, ¶123. The net result is a display that would appear black or dark grey. *Id.*

At a minimum, it would have been obvious to manufacture Igarashi's display to have a non-yellow color impression. Igarashi discloses a flat panel active matrix OLED display. *See* Igarashi, ¶[0112]. Such displays appear black (or dark grey) when the pixels are off to maximize the display's contrast. Ex. 1003, ¶124. An OLED display that had a yellow color impression when switched-off would be unable to effectively display black (or other dark colors), would produce a yellow tint, and would have a washed-out, low-contrast appearance. *Id.* Therefore, a POSITA would understand that Igarashi's display would appear black (or dark grey) when it is off. Ex. 1003, ¶123. And it would have been obvious to implement Igarashi's display such that it appears black (or dark grey) when it is off, in order to maximize contrast and appear consistent with typical flat panel displays. *Id.*, ¶124.

Indeed, this was the Examiner's rationale for finding that this claim element would have been obvious based on the flat-panel OLED display of Kobori:

Regarding claim 4, Kobori is silent as to the color of the device when it is turned off, but *one of ordinary skill in the art would have reasonably contemplated having the display appear black to an observer as is expected for flat panel displays*. Therefore, it would have been obvious to one of ordinary skill in the art to have the display appear black to an observer in order to meet flat panel display appearance expectations.

Ex. 1002 (File History) at 513. The Examiner’s analysis—which the applicants did not dispute—is equally applicable to the flat-panel OLED display of Igarashi. *See* Ex. 1003, ¶125.

The additional element of dependent claim 3 is satisfied or rendered obvious even if it were interpreted to require a “non-yellow color impression” when the device is turned on. A POSITA would understand that Igarashi’s display would have a non-yellow color impression when in the on state. Ex. 1003, ¶¶126–27. Igarashi’s display functions to reproduce a gamut of colors, by combining light from its red, green, blue, and cyan pixels. *See* Igarashi, ¶[0113] (“The pixel structure can be selected according to a desired color reproducing range.”); *see also* Ex. 1003, ¶126. Therefore, it would have been at least obvious to use Igarashi’s display to reproduce a range of colors, which in general-purpose usage would include non-yellow colors. *Id.* As a result, it would have been obvious for Igarashi’s display (optoelectronic device) to have a non-yellow color impression.

- 4. Dependent Claim 4: The optoelectronic device as claimed in claim 1, wherein the filter layer is configured to convert the electromagnetic radiation having the third wavelength spectrum into an electromagnetic radiation from a non-visible wavelength range.**

Claim 4 would have been obvious based on Igarashi. A POSITA would understand that Igarashi’s color filter 30B (“filter layer”) absorbs green light (“radiation having the third wavelength spectrum”). As the ’547 patent explains, this

limitation is satisfied by a filter layer that absorbs such light, because absorbed light is converted “into heat or thermal radiation,” which is “electromagnetic radiation from a non-visible wavelength range.” ’547 patent, 3:46–65. This is consistent with the understanding of a POSITA as well as claim 5, which depends on claim 4 and recites that the filter layer “is further configured to absorb” such radiation. Ex. 1003, ¶¶129–32.

As discussed above for Element 1[d], Igarashi’s color filter 30B is at least partially opaque to red and green light. Color filters commonly “filter out” light by absorbing light that is not transmitted. Ex. 1003, ¶129. For example, Smith explains that “[a]bsorption filters are composed of materials which transmit light selectively; that is, they transmit certain wavelengths more than others.” Ex. 1009 at 224; *see also* Shiotani, Abstract, ¶[0018] (explaining that a “color filter layer 7B for blue” serves to “transmit[] light in the blue wavelength region and absorb[] light in other wavelength regions”); Ex. 1003, ¶129. Such absorptive filters were the most common type of filter used in displays. *Id.*, ¶133. It therefore would have been at least obvious to use a blue filter that absorbs green light for Igarashi’s color filter 30B. *Id.* Moreover, a POSITA would have a reasonable expectation of success in using a well-established type of filter for its customary purpose. *Id.*

Since absorbed light is converted into electromagnetic radiation from a non-visible wavelength range (i.e., heat or thermal/infrared radiation), it would have been

obvious to use a filter layer that “is configured to convert the electromagnetic radiation having the third wavelength spectrum” (green light) “into an electromagnetic radiation from a non-visible wavelength range” (infrared radiation)—i.e., a blue color filter that absorbs green light—for Igarashi’s color filter 30B. Ex. 1003, ¶¶132–34.

5. Dependent Claim 5: The optoelectronic device as claimed in claim 4, wherein the filter layer is further configured to absorb the electromagnetic radiation having the third wavelength spectrum.

Claim 5 would have been obvious based on Igarashi. As discussed above for Claim 4, it would have been obvious to use a filter configured to “absorb the electromagnetic radiation having the third wavelength spectrum” (green light) for Igarashi’s color filter 30B.

6. Dependent Claim 8

a. The optoelectronic device as claimed in claim 1, wherein the first regions each have a second filter layer disposed downstream of the wavelength conversion layer in the beam path of the electromagnetic radiation emitted by the organic layer sequence and

Igarashi teaches or suggests this element of the claim. Each green pixel in Igarashi’s display includes a color filter 30G, which is the claimed “second filter layer.” *See* Igarashi, ¶[00089]; Ex. 1003, ¶136. As shown in Figure 5 below, these color filters are included in the “first regions” corresponding to each of the green pixels.

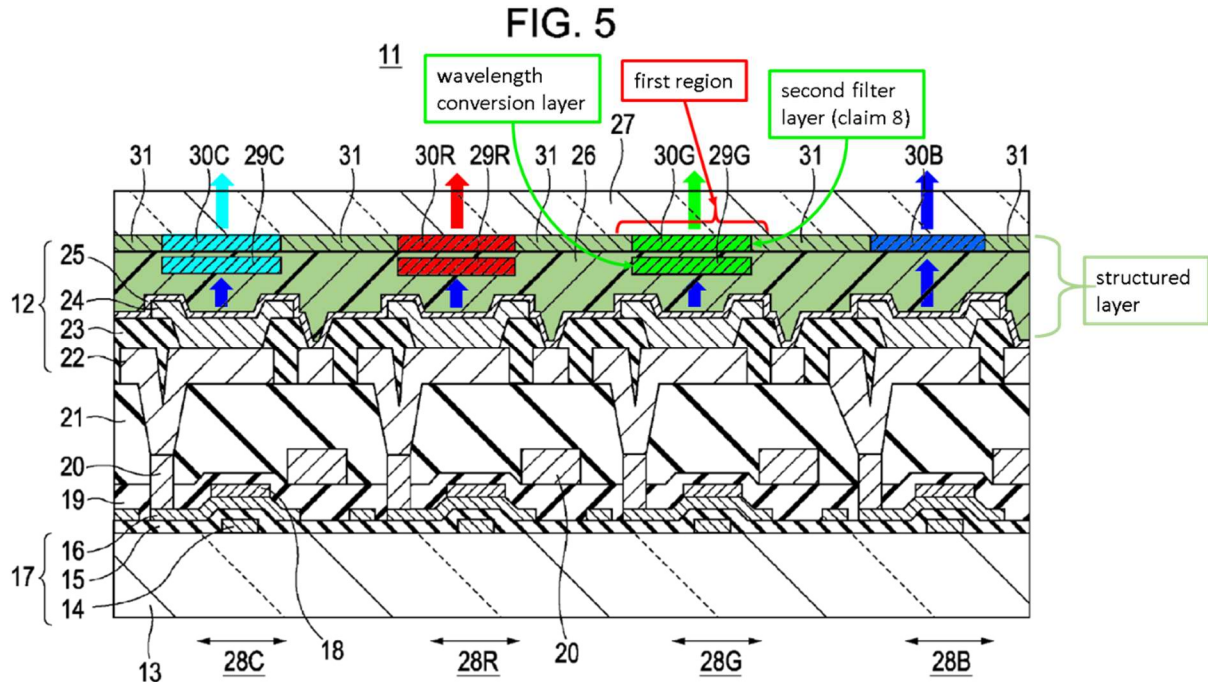

Igarashi, Fig. 5 (annotated).

Color filter 30G is “disposed downstream of the wavelength conversion layer” (color conversion layer 29G) “in the beam path of the electromagnetic radiation emitted by the organic layer sequence” (organic electroluminescent element 12). As explained for Element 1[c], Igarashi’s “organic EL element [12] has a top emission structure,” Igarashi, ¶[0112], and thus emits electromagnetic radiation in an upward direction and which passes through the “color conversion layer” and “second filter layer,” as indicated by the arrows in the annotated figure above.

- b. which is at least partially opaque to an electromagnetic radiation having a fourth wavelength spectrum which corresponds to at least one part of the first wavelength spectrum.**

Igarashi teaches or suggests this element. A POSITA would understand that a color filter for a green pixel is at least partially opaque to light of other colors, including red and blue light. As Dr. Eden explains, “blocking the passage of specified wavelengths of light is precisely the function of color filters.” Ex. 1003, ¶141. Such filters are “designed to ‘pass’ (transmit) optical wavelengths in a desired range while rejecting (blocking) those wavelengths lying outside that range.” *Id.* For instance, Smith explains that “[a]bsorption filters are composed of materials which transmit light selectively; that is, they transmit certain wavelengths more than others.” Ex. 1009 at 224. Shiotani likewise states that a “color filter layer 7G for green” serves to “transmit[] light in the green wavelength region and absorb[] light in other wavelength regions when light containing light in the green wavelength region is incident.” Shiotani, Abstract, ¶[0018]. In particular, the green filter is at least partially opaque to the blue light emitted by Igarashi’s organic layer 24.

Green color filter 30G therefore constitutes a second filter layer “which is at least partially opaque to an electromagnetic radiation having a fourth wavelength spectrum” (blue light) “which corresponds to at least one part of the first wavelength spectrum” (the light emitted by organic layer 24).

7. Dependent Claim 9: The optoelectronic device as claimed in claim 8, wherein the second filter layer is configured at least partially to absorb the electromagnetic radiation having the fourth wavelength spectrum.

Claim 9 would have been obvious based on Igarashi. As discussed above for Element 8[b], a POSITA would understand that Igarashi's color filter 30G for the green pixel (second filter layer) is at least partially opaque to blue light (electromagnetic radiation having a fourth wavelength spectrum).

Common optical filters, especially those used in displays, were absorptive filters. Ex. 1003, ¶¶145–46 ; *see also* Smith (Ex. 1009) at 224 (“Absorption filters are composed of materials which transmit light selectively; that is, they transmit certain wavelengths more than others.”); Shiotani, Abstract, ¶[0018] (explaining that a “color filter layer 7B for blue” serves to “transmit[] light in the blue wavelength region and absorb[] light in other wavelength regions when light containing light in the blue wavelength region is incident”); Huang at 502 (describing filters having a “non-transparent or absorptive region”). Such absorptive filters were the most common type of filter used in displays. *Id.*, ¶133. A POSITA would therefore have been motivated to use an absorptive filter and would have had a reasonable expectation of success in using a well-established type of filter for its customary purpose.

Thus, it would have been at least obvious to use a color filter that is configured at least partially to absorb blue light (electromagnetic radiation having a fourth

wavelength spectrum) for Igarashi's color filter 30G (the second filter layer). Ex. 1003, ¶145.

8. Dependent Claim 10: The optoelectronic device as claimed in claim 8, wherein the second filter layer is configured at least partially to reflect the electromagnetic radiation having the fourth wavelength spectrum.

Claim 10 would have been obvious based on Igarashi. As discussed above for Element 8[b], a POSITA would understand that Igarashi's green color filter 30G (the claimed "second filter layer") is at least partially opaque to blue light ("electromagnetic radiation having the fourth wavelength spectrum"). It would have been obvious for color filter 30G to be "configured at least partially to reflect" such light.

A POSITA would understand that color filters reflect a portion of the electromagnetic radiation incident upon them. As Dr. Eden explains, when a beam of radiation strikes an interface between two different transparent media, some of the light will be reflected. Ex. 1003, ¶148; *see* Hecht (Ex. 1014) at 95 (explaining that, "at an interface between two different transparent media (such as air and glass)...*some light is always scattered backward*, and we call this phenomenon reflection").

Thus, when radiation passes from Igarashi's color conversion layer 29G to color filter 30G, which is made of a different material, a portion of the radiation will be reflected back toward the organic electroluminescent element 12 (rather than

passing into the color filter). Ex. 1003, ¶148; *see* Mourad (Ex. 1015) at 15 (“At the interface of an optical filter, part of the incident radiant power is lost due to surface reflection resulting from the discontinuity of the refractive index.”). This reflected radiation will comprise blue light from Igarashi’s organic electroluminescent element, given that the color conversion layer 29G will not convert fully 100% of the blue light to green. Ex. 1003, ¶148. Thus, a POSITA would understand that Igarashi’s color filter 30G (second filter layer) is configured at least partially to reflect the electromagnetic radiation having the fourth wavelength spectrum (blue light).

Indeed, this was the Examiner’s rationale for finding that this claim element was disclosed in the OLED display of Kobori:

Regarding claim 11, Kobori further discloses wherein the second filter layer is designed at least partially to reflect the electromagnetic radiation having the fourth wavelength spectrum (22G; the Examiner notes that *the interface between layers 23 and 22G will characteristically reflect some of the electromagnetic radiation emitted by the organic layer sequence*).

Ex. 1002 (File History) at 509. The Examiner’s analysis—which the applicants did not dispute—is equally applicable to Igarashi, in which some radiation from the organic layer sequence similarly is reflected at the interface between the wavelength

conversion layer (Igarashi's color conversion layer 29G) and second filter layer (Igarashi's color filter 30G), as shown below:

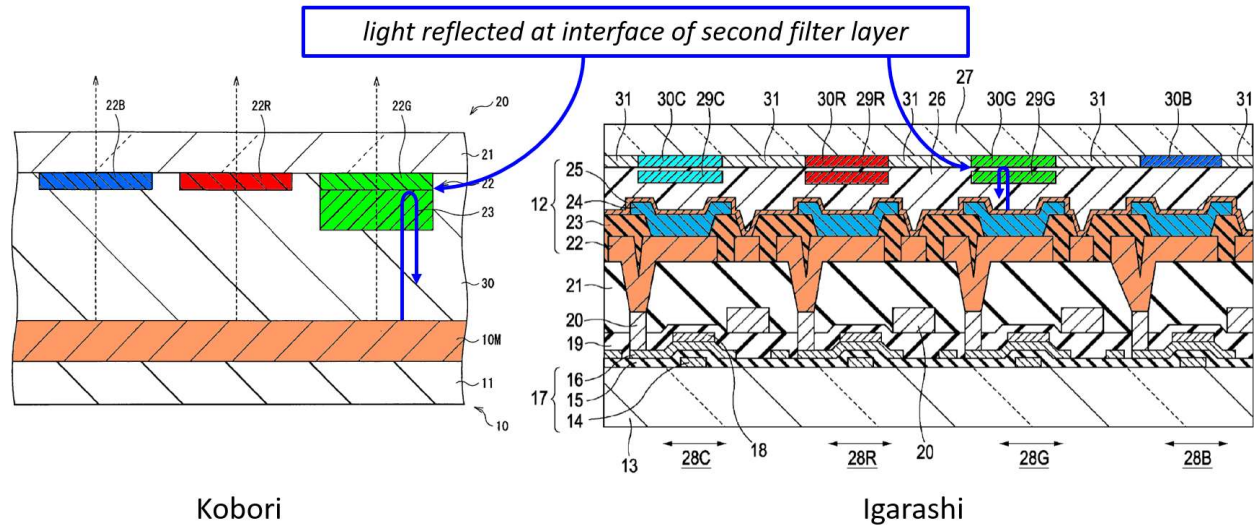

Kobori, Fig. 1 and Igarashi, Fig. 5 (annotated). See Ex. 1003, ¶150.

9. **Dependent Claim 11: The optoelectronic device as claimed in claim 1, further comprising an encapsulation one of disposed upstream and disposed downstream of the structured layer in the beam path of the electromagnetic radiation emitted by the organic layer sequence.**

Igarashi teaches or suggests the elements of this claim. As shown in Figure 5, below, “a sealing substrate 27 composed of for example, glass is provided on the entire surface to form the display device 11.” Igarashi, ¶[0089].

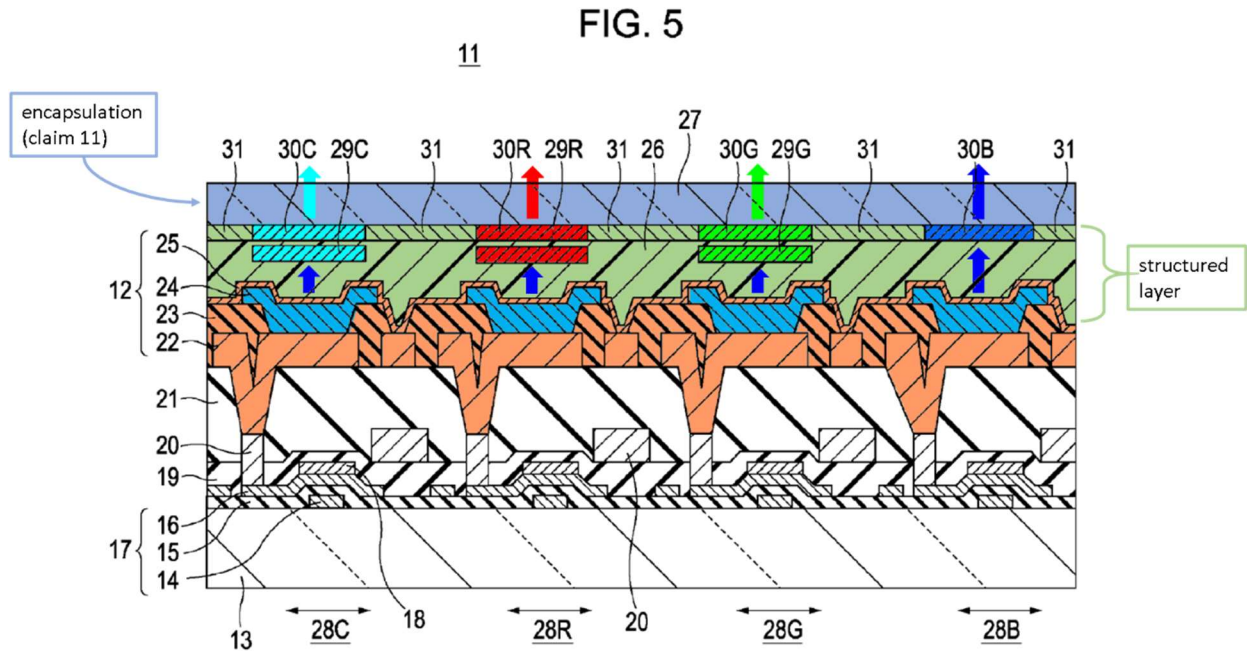

Id., Fig. 5 (annotated).

As a POSITA would understand, Igarashi's sealing substrate is an encapsulation and serves to protect the device from environmental effects. Ex. 1003, ¶153; *see also* Pilcher, 1:8–13 (“It is well known in the art to encapsulate an OLED device by physically mating a top glass (or other suitable material) layer over, but usually not touching, the OLED device....”).

As shown in Figure 5 above, this sealing substrate is disposed downstream of the structured layer in the beam path of the electromagnetic radiation emitted by the organic layer sequence. As discussed above for Element 1[b], Igarashi's “organic EL element [12] has a top emission structure,” Igarashi, ¶[0112], and thus emits electromagnetic radiation in an upward direction, as shown by the arrows added to the figure above. Ex. 1003, ¶154.

- 10. Dependent Claim 13: The optoelectronic device as claimed in claim 1, wherein the electromagnetic radiation which is emitted by the optoelectronic device corresponds to a superimposition of the electromagnetic radiation having the first wavelength spectrum and the electromagnetic radiation having the second wavelength spectrum.**

Claim 13 would have been obvious to a POSITA based on Igarashi. Igarashi discloses a display comprising red, green, blue, and cyan pixels. *See* Igarashi, ¶[0089], Fig. 5. The purpose of having different colored pixels is to be able to reproduce a range of visible colors by combining light from such pixels. Ex. 1003, ¶157; Murdoch (Ex. 1016), 1:17–23. Igarashi’s display produces a gamut of colors by combining light from its red, green, blue, and cyan pixels. *See* Igarashi, ¶[0113] (“The pixel structure can be selected according to a desired color reproducing range.”).

Thus, a POSITA would understand that the light of Igarashi’s blue and green pixels would be combined, through superimposition, to create a range of colors. Ex. 1003, ¶157. For example, it would have been at least obvious to use Igarashi’s display to display an image containing white regions, which would be formed by simultaneously turning on the red, green, blue, and cyan pixels. Ex. 1003, ¶157. In that case the electromagnetic radiation emitted by the display “corresponds to a superimposition of the electromagnetic radiation having the first wavelength spectrum” (blue light from the blue pixels) and “the electromagnetic radiation

having the second wavelength spectrum” (green light from the green pixels). Ex. 1003, ¶158.

B. Ground II: Claim 12 Is Obvious Based on Igarashi and Pilcher

1. Dependent Claim 12: The optoelectronic device as claimed in claim 11, wherein the encapsulation comprises a thin-film encapsulation.

Claim 12 would have been obvious to a POSITA based on Igarashi and Pilcher. Igarashi discloses that its “encapsulation” (sealing substrate 27) may be “composed of for example glass.” Igarashi, ¶[0089]. However, it would have been obvious to a POSITA to use a thin film encapsulation instead of glass. Ex. 1003, ¶¶159–60.

Prior to the ’547 patent, thin-film encapsulation was a well-known alternative to glass for encapsulating organic light-emitting displays such as Igarashi’s display device. As explained by Pilcher, thin film encapsulation was “typically described as a ‘polymer multi-layer’ (PML) comprising alternating and repeating layers of an organic (usually acrylate or the like) and a barrier layer” that was “to provide a cheaper and better manner of encapsulation.” Pilcher, 1:10–22. And thin film encapsulation was known to provide a number of advantages over glass:

The advantages of direct thin-film encapsulation over the prior art are primarily cost reduction and improved reliability. Using direct thin-film encapsulation, the package may also be thinner and/or lighter and/or mechanically more flexible.

Pilcher, 1:48–55.

It would have been obvious to a POSITA to use “encapsulation [that] comprises a thin-film encapsulation” in the display of Igarashi. Ex. 1003, ¶160. A POSITA would have been motivated to use thin-film encapsulation to achieve the advantages discussed in Pilcher, including reduced cost and improved reliability. *Id.* Additionally, much of the structure of the OLED display described in Igarashi was manufactured using thin film deposition techniques. *Id.* A POSITA would have been motivated to use thin film encapsulation to reduce the number of different processes required to manufacture the display. *Id.* A POSITA would have reasonably expected success in using thin-film encapsulation in Igarashi’s display. Thin-film encapsulation was a well-known alternative to glass encapsulation and a POSITA would be familiar with the manufacturing techniques for producing a thin film encapsulation. *Id.* The replacement of a glass encapsulation with a thin-film encapsulation merely replaces one well-known alternative with another. *Id.* Implementing such a predictable variation of the encapsulation method already disclosed in Igarashi would have been a routine matter, well-within the ability of a POSITA. *Id.*

C. Ground III: Claim 14 Is Obvious Based on Igarashi and Dresevic

1. Dependent Claim 14

- a. **The optoelectronic device as claimed in claim 1, wherein the structured layer has at least one of striped, crossed-striped, circular, triangular, and rectangular regions.**

Claim 14 would have been obvious to a POSITA based on Igarashi and Dresevic. It would have been obvious for Igarashi’s structured layer to have striped and rectangular regions. Igarashi’s Figure 5 presents a “schematic cross-sectional view” of its display device. Igarashi, ¶[0036]. This figure shows one pixel of each color (red, green, blue, cyan) arranged in a side-by-side arrangement:

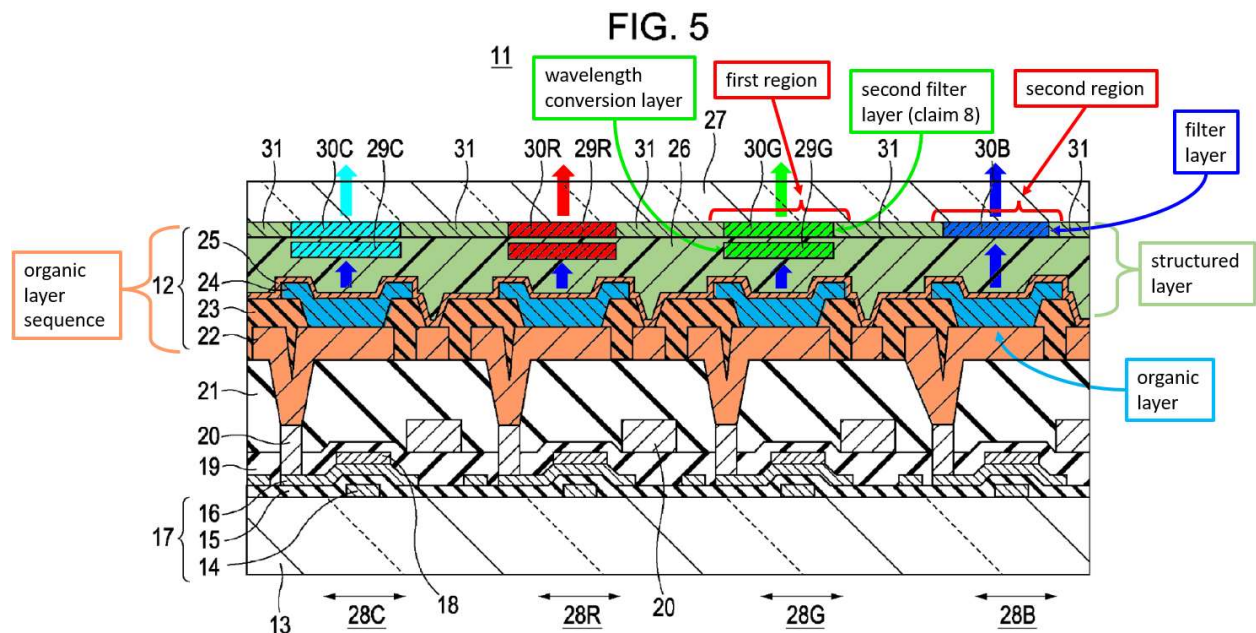

Id., Fig. 5 (annotated).

A POSITA would understand that Igarashi’s “active matrix” display device (Igarashi, ¶[0112]) includes many such pixels of each color, arranged in columns

and rows (i.e., as a matrix), as discussed above for Element 1[b]. Ex. 1003, ¶162. Such a matrix arrangement would naturally result in Igarashi's display having a striped, rectangular pixel arrangement, similar to Figure 1 of the Dresevic reference:

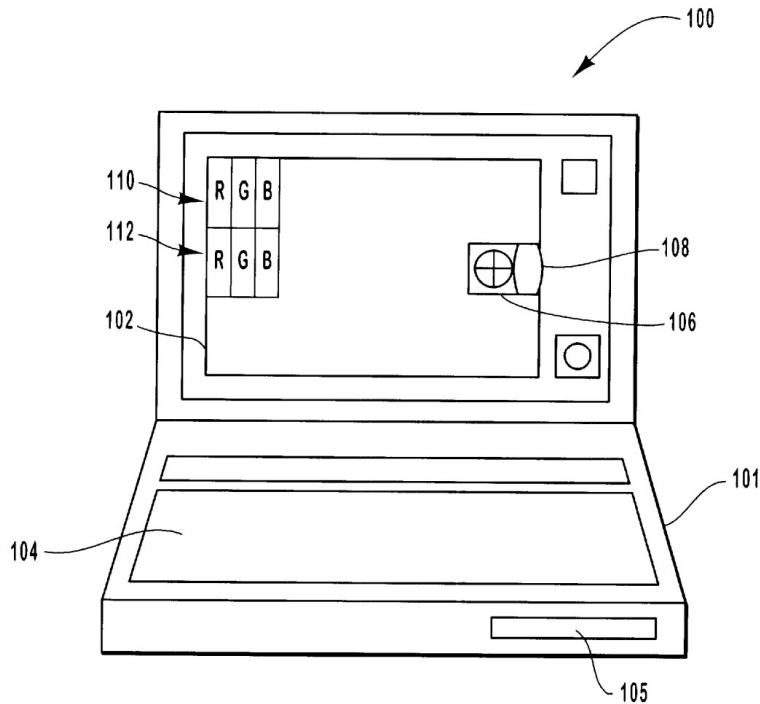

Dresevic, Fig. 1. Indeed, as Dresevic explains, this striped pixel arrangement was common in computer displays:

In displays commonly used for computer applications, each pixel on a color LCD display usually comprises three non-square elements, i.e., red, green and blue (RGB) pixel sub-components....LCD displays of this type comprise a series of *RGB pixel sub-components which are commonly arranged to form stripes along the display*. The RGB stripes normally run the entire length of the display in one direction.

Drešević, 2:3–13. This pixel arrangement was likewise typical for OLED displays. See Murdoch (Ex. 1016), 4:28–29 (“FIG. 6a is a depiction of a typical prior art RGB stripe arrangement of OLEDs”), 12:3–5 (discussing the “common arrangement of red 84, green 86, and blue 88 OLEDs arranged in a stripe pattern” as “shown in FIG. 6a”). In the context of Igarashi, which additionally includes cyan pixels, this striping would take the form of a CRGB striped arrangement, as shown in the following demonstrative:

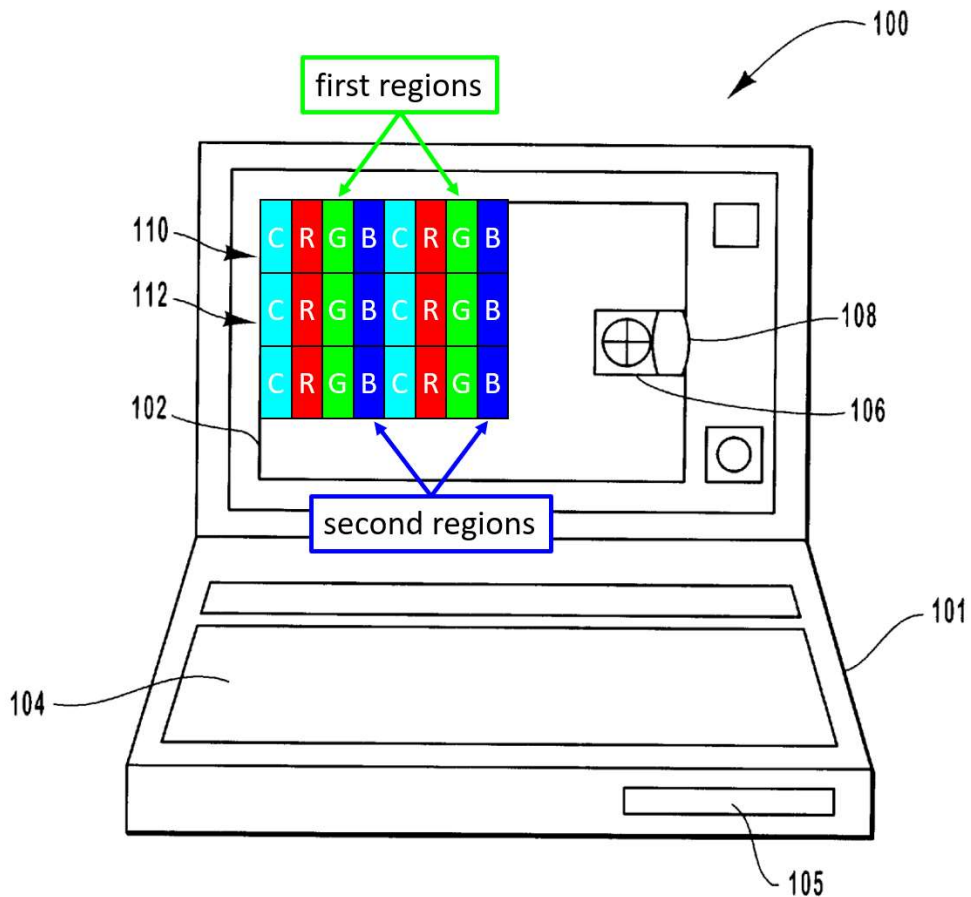

Ex. 1003, ¶¶162–64. This would result in Igarashi’s structured layer having first regions (areas of green pixels) and second regions (areas of blue pixels) that are striped and rectangular, as illustrated in the figure above.

Indeed, the Examiner found that this claim element would have been obvious based on a reference, Krummacher, that was “silent as to a specific shape”:

Regarding claim 15, Krummacher teaches wherein the structured layer may have any desired shape, but is silent as to a specific shape. However, one of ordinary skill in the art would have reasonably contemplated having the shapes be rectangular in order to provide a pixelated appearance. Therefore, it would have been obvious to one of ordinary skill in the art to have the structured layer have the shapes be rectangular in order to provide a pixelated appearance.

Ex. 1002 (File History) at 512. The Examiner’s analysis—which the applicants did not dispute—is likewise applicable to Igarashi. As is evident from Dresevic Figure 1 as well as Murdoch Figure 6*a*, it was common for flat panel displays to have rectangular pixels. Ex. 1003, ¶163. It would have been obvious for Igarashi’s structured layer to have rectangular regions in order for Igarashi’s display to have a pixelated appearance that is consistent with other such flat panel displays. *Id.*, ¶166.

D. Ground IV: Claims 1–5, 8–10, and 13 Are Obvious Based on Shiotani

Shiotani discloses a display device, illustrated in Figure 7, that teaches or suggests all elements of claims 1–5, 8–10, and 13 of the '547 patent, as discussed below:

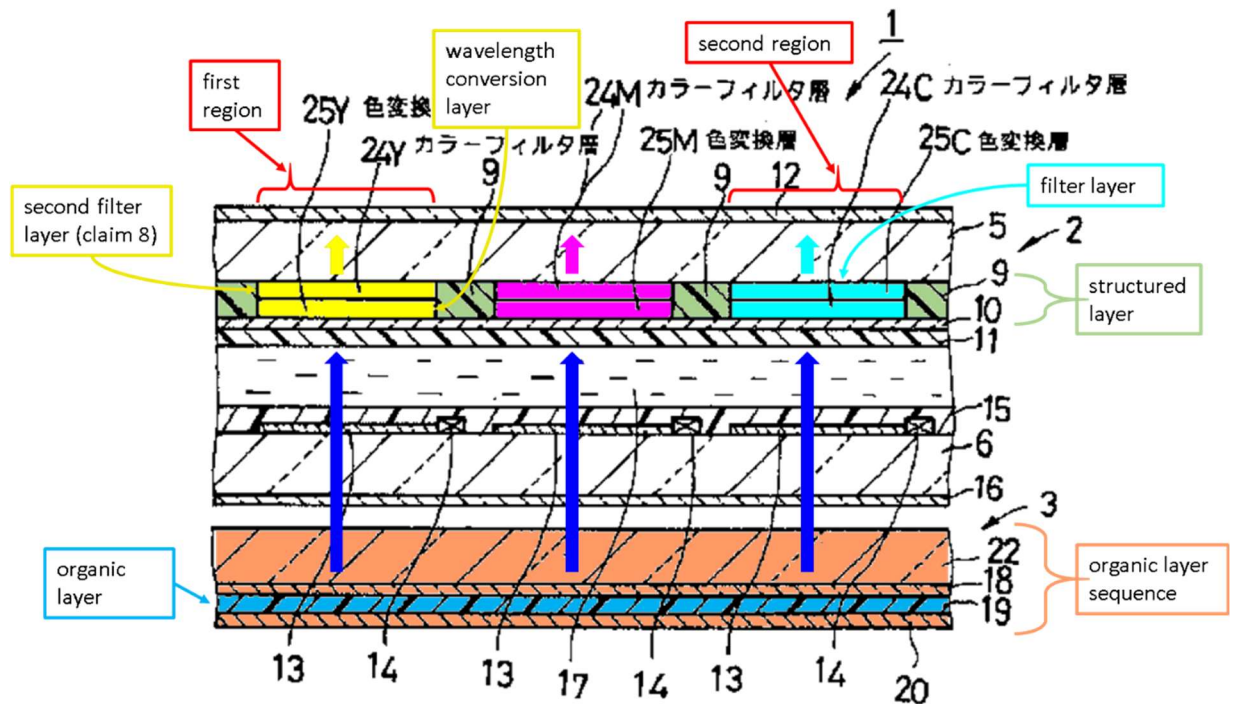

Shiotani, Fig. 7 (annotated).

1. Independent Claim 1

a. Preamble: An optoelectronic device, comprising:

To the extent the preamble is limiting, Shiotani discloses it. Shiotani discloses a “liquid crystal display device provided with a color conversion layer capable of color display.” Shiotani, ¶[0001]. Shiotani’s display is an electronic device that emits light—an optoelectronic device. Ex. 1003, ¶¶169–71.

- b. Element 1[a]: an organic layer sequence which emits an electromagnetic radiation having a first wavelength spectrum during operation; and**

Shiotani discloses this element. As shown in Figure 7, below, Shiotani's display device includes an "EL light-emitting element 3," Shiotani, ¶[0021], comprising an "EL light-emitting layer 19 [] formed of an organic EL material that generates blue light when a predetermined voltage is applied between the front and rear electrodes 18 and 20," *id.*, ¶[0022].⁵

⁵ Although Petitioner generally relies on the embodiment in Figure 7 ("Embodiment 4"), Shiotani explains that, apart from the color filter and color conversion layers of this embodiment, "the configuration of other parts is the same as that in embodiment 1." Shiotani ¶ [0039]. Thus, the disclosures in paragraphs [0021]–[0022] concerning Figure 1 are equally pertinent to Figure 7.

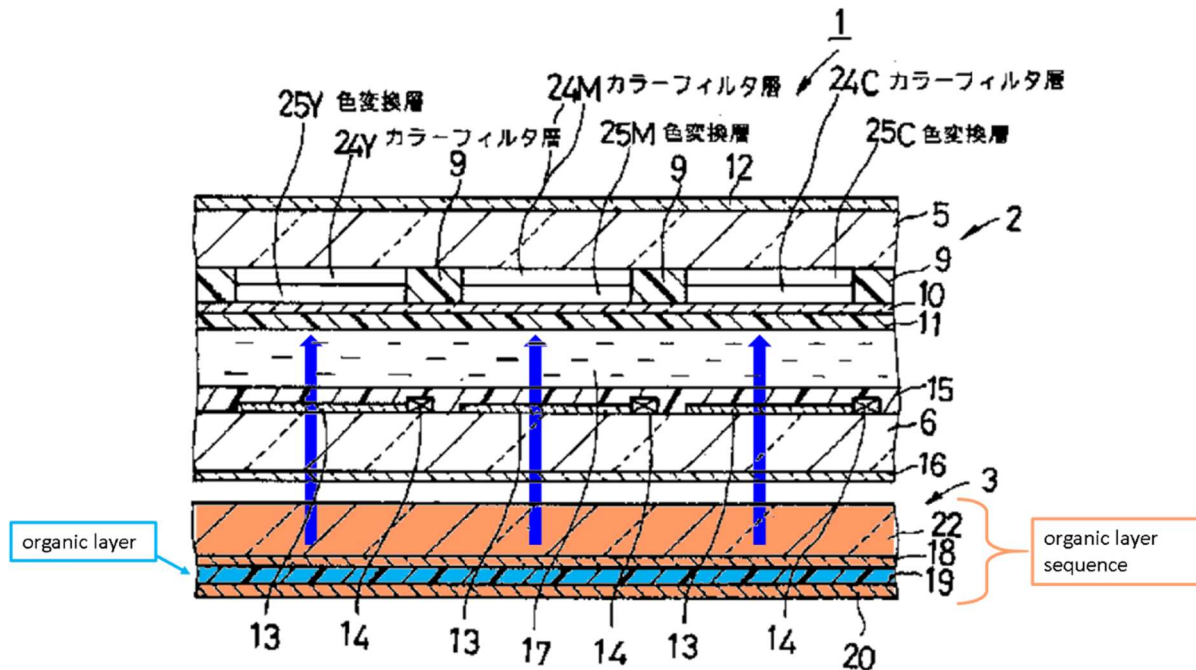

Id., Fig. 7 (annotated).

Shiotani’s EL light-emitting element 3 comprises an “organic layer sequence” as that term is used in the ’547 patent. Ex. 1003, ¶172. The ’547 patent states that “the organic layer sequence can be embodied in particular as an organic light-emitting diode (OLED),” explaining that such “an OLED can have an *organic layer* or a *layer sequence comprising at least one organic layer*, having an active region that can emit electromagnetic radiation during operation.” ’547 patent, 4:33–38. Similarly, Shiotani’s EL light-emitting element 3 includes an organic EL light-emitting layer 19 that “is formed of an organic EL material” and “is configured from three layers,” including “a hole-transport layer,” “a light emitting layer,” and “an electron transport layer.” Shiotani, ¶[0022]; Ex. 1003, ¶¶173–74.

The '547 patent depicts its “organic layer sequence 1” as including “electrode 10,” *see* '547 patent, figs. 1A–B, 10:5–12, and states the “OLED can have a first electrode and a second electrode, wherein the organic layer or the layer sequence comprising at least one organic layer ... can be arranged between the first and second electrodes,” *id.*, 4:38–42. To the extent that the “organic layer sequence” limitation requires such electrodes, Shiotani’s EL light-emitting element 3 includes “a front electrode 18” and “a light-reflective rear electrode 20.” Shiotani, ¶[0021]. Ex. 1003, ¶177.

Shiotani discloses that the organic EL material “generates blue light when a predetermined voltage is applied between the front and rear electrodes.” Shiotani, ¶[0022]. Thus, Shiotani discloses an “organic layer sequence which emits an electromagnetic radiation having a first wavelength spectrum.” Ex. 1003, ¶175.

c. Element 1[b]: a structured layer disposed downstream of the organic layer sequence in a beam path of the electromagnetic radiation emitted by the organic layer sequence and including first and second regions;

Shiotani discloses this element. As shown in Figure 7, below, Shiotani’s display includes a structured layer comprising (i) color filter layers 24Y, 24M, and 24C, Shiotani, ¶[0040]; (ii) color conversion layers 25Y, 25M; and 25C, *id.*; and (iii) “a black mask layer 9 made of resin,” *id.*, ¶[0018]; Ex. 1003, ¶¶178–79.

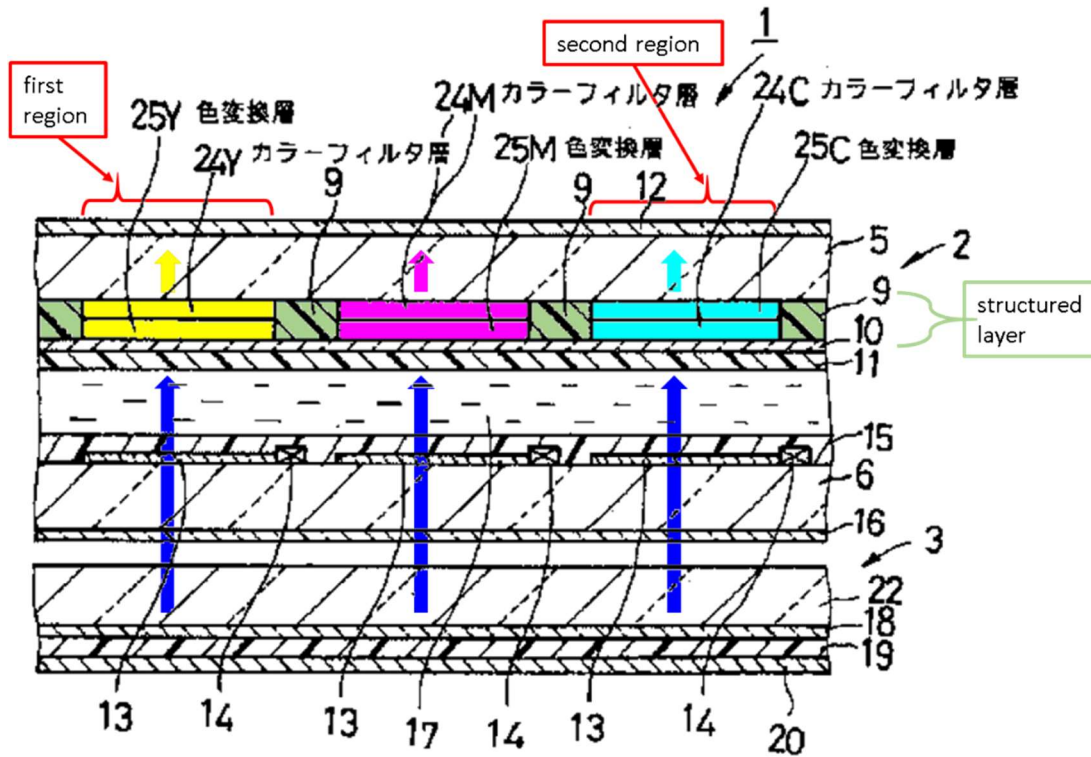

Id., Fig. 7 (annotated).

Shiotani’s structured layer includes first and second regions, corresponding to yellow pixels and cyan pixels, respectively, as annotated above. This structured layer is disposed downstream of the organic layer sequence in a beam path of the electromagnetic radiation emitted by the organic layer sequence. Shiotani’s EL light-emitting element 3 serves as a “backlight of the liquid crystal cell 2,” Shiotani, ¶[0028], and emits light through the structured layer’s color conversion layers 25Y, 25M, and 25C and color filter layers 24Y, 24M, and 24C, *id.*, ¶[0045]; see Ex. 1003, ¶¶180–82.

While Figure 7 shows only one pixel of each color, a POSITA would understand that Shiotani's display device includes many pixels of each color, arranged in columns and rows (i.e., as a matrix). Ex. 1003, ¶181. Thus, to the extent the claim requires more than one "first regions" and/or "second regions" conversion layer," Shiotani's structured layer includes a plurality of first regions (corresponding to yellow pixels) and a plurality of second regions (corresponding to cyan pixels).

Id.

- d. Element 1[c]: wherein the first regions each include a wavelength conversion layer configured to convert at least partially electromagnetic radiation having a first wavelength spectrum into an electromagnetic radiation having a second wavelength spectrum;**

Shiotani discloses this element. As shown in Figure 7 below, each of the first regions of Shiotani's structured layer includes a "color conversion layer 25Y that converts the B (blue) component light into Y component [i.e., yellow] light." Shiotani, ¶[0040]; *see also id.*, ¶[0045]; Ex. 1003, ¶184.

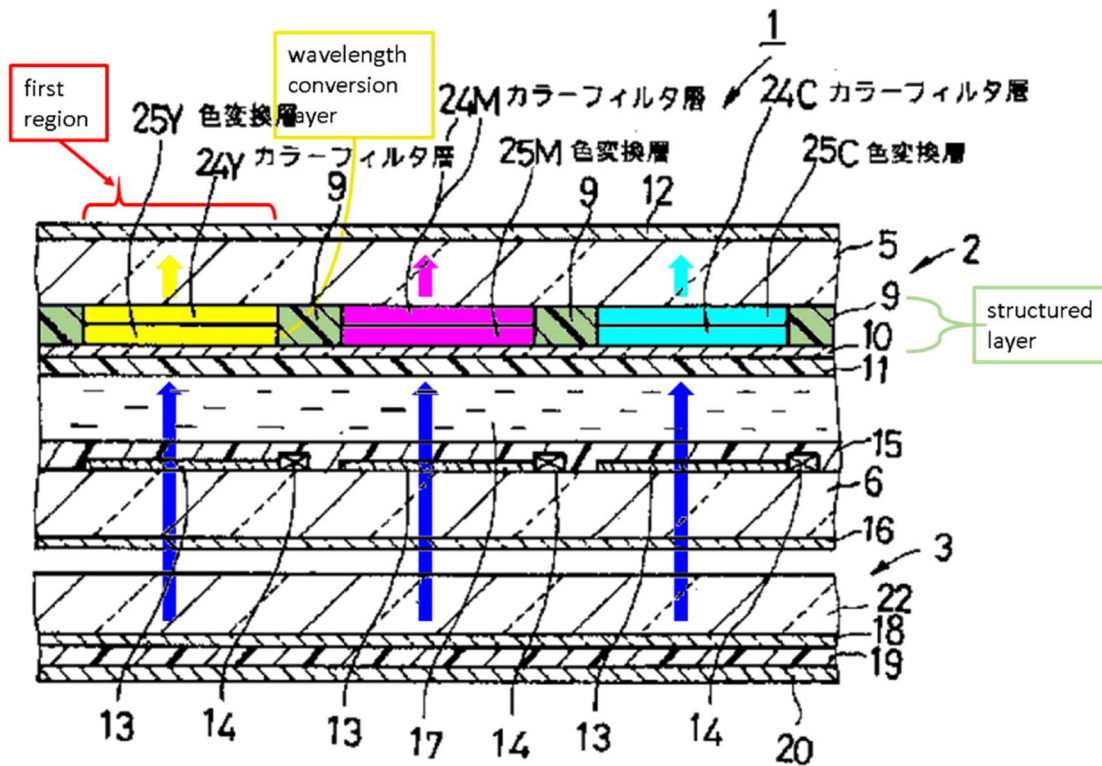

Shiotani, Fig. 7 (annotated).

More specifically, “the color conversion layer 25Y is a mixture of a color conversion layer that converts the B [blue] component light into R [red] component light and a color conversion layer that converts the B [blue] component light into G [green] component light to obtain Y [yellow], a color mixture of the R [red] and G [green] component light.” Shiotani, ¶[0041]. This is illustrated in Figure 9:

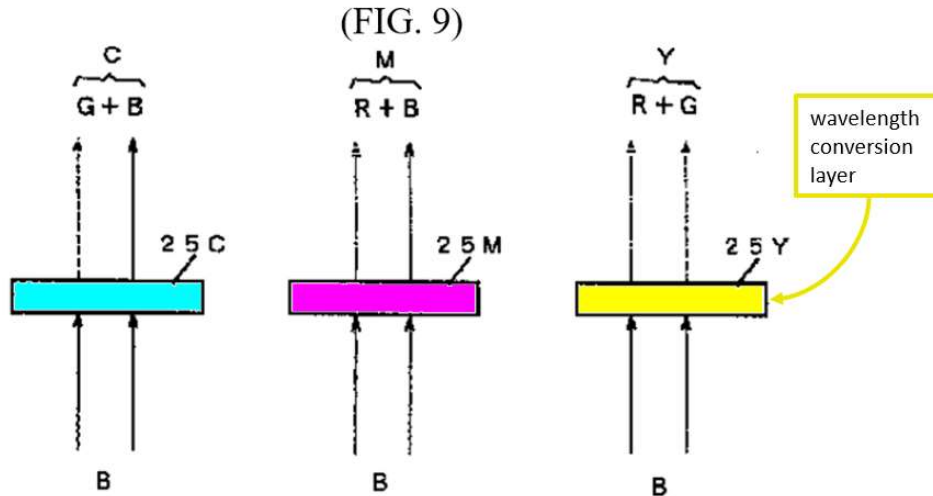

Id., Fig. 9 (annotated).

Accordingly, color conversion layer 25Y constitutes a “wavelength conversion layer configured to convert at least partially electromagnetic radiation having a first wavelength spectrum” (blue light) “into an electromagnetic radiation having a second wavelength spectrum” (yellow light as a mixture of red and green light). Ex. 1003, ¶¶185–86.

- e. **Element 1[d]: wherein the second regions each include a filter layer which is at least partially opaque to an electromagnetic radiation having a third wavelength spectrum which corresponds to at least one part of the second wavelength spectrum;**

Shiotani discloses this element. As shown in Figure 7 below, each of the second regions of Shiotani’s structured layer includes “color filter layer 24C.” Shiotani, ¶[0040]; Ex. 1003, ¶189.

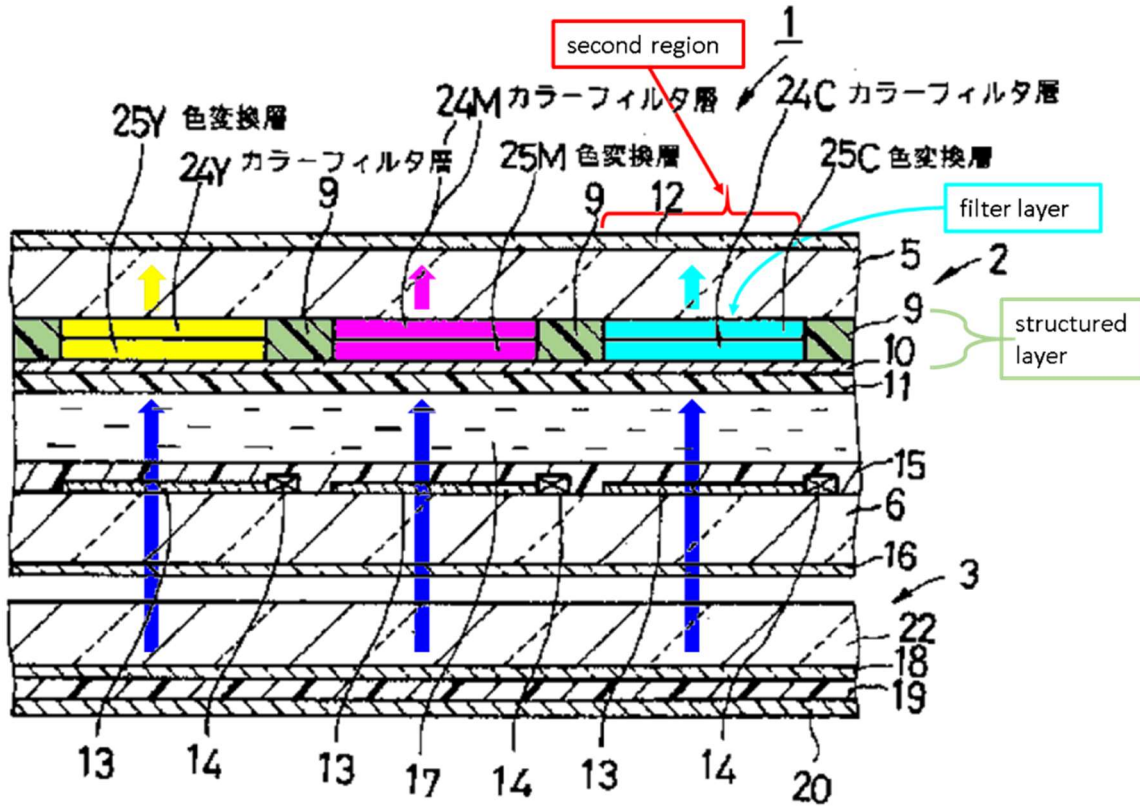

Shiotani, Fig. 7 (annotated).

Shiotani explains that “color filter layer 24C...transmits only the C component” (i.e., cyan light). Shiotani, ¶[0040]. It does so by allowing transmission of green and blue light, but not red light, as illustrated in Figure 8:

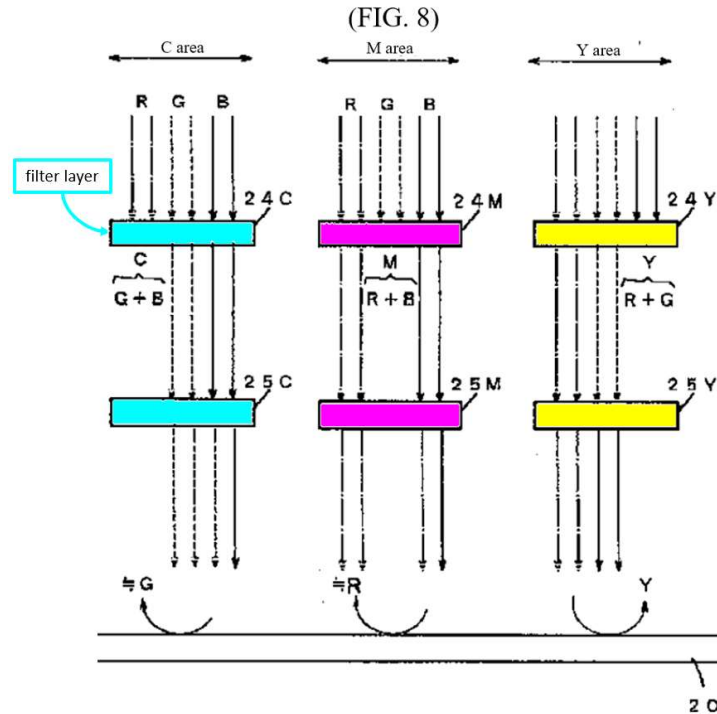

Shiotani, Fig. 8 (annotated); *see also id.*, ¶[0042] (“The G component light and the B component light pass through the C area.”); Ex. 1003, ¶¶190–91.

Color filter layer 24C is therefore “a filter layer which is at least partially opaque to an electromagnetic radiation having a third wavelength spectrum” (red light) “which corresponds to at least one part of the second wavelength spectrum” (yellow light in the form of a mixture of red and green light as discussed for Element 1[c]). Ex. 1003, ¶¶189–93.

- f. **Element 1[e]: wherein the first and second regions of the structured layer are arranged laterally in a beam path of the optoelectronic device; and**

Shiotani discloses this element. As shown in Figure 7 below, “the first and second regions are arranged laterally” (left to right) “in a beam path of the

optoelectronic device.” As discussed above for Element 1[b], Shiotani’s light-emitting element 3 serves as a “backlight of the liquid crystal cell 2,” Shiotani, ¶[0028], and emits light through the structured layer’s color conversion layers and color filter layers, *id.*, ¶[0045]; Ex. 1003, ¶194–96.

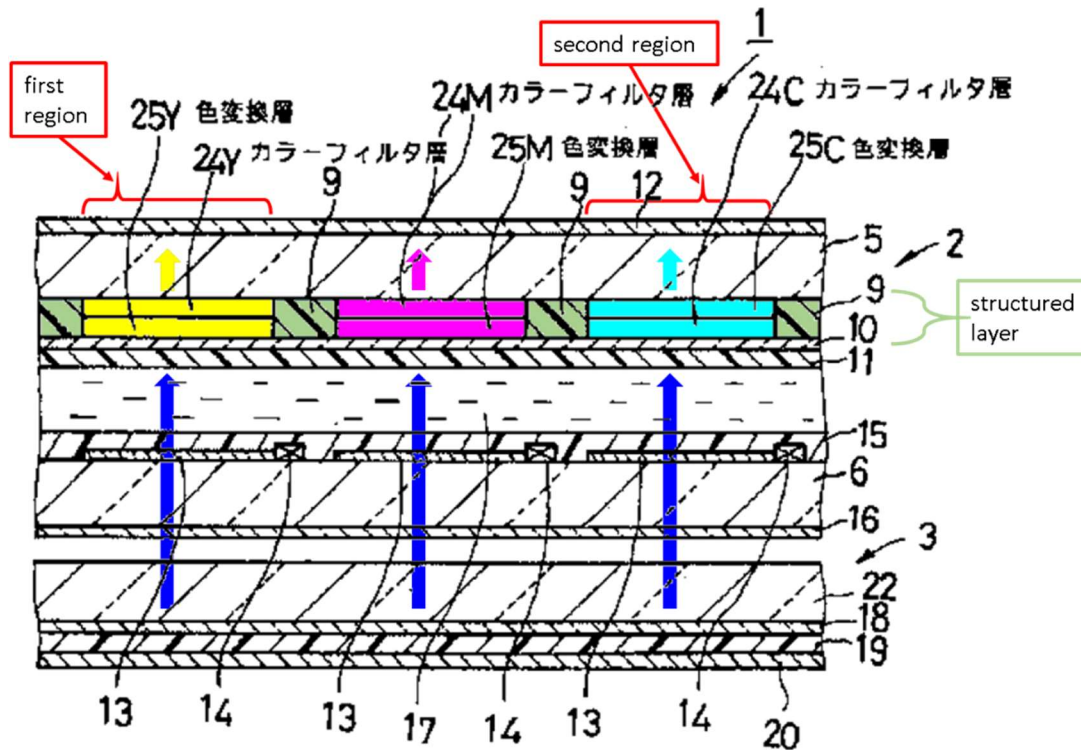

Shiotani, Fig. 7 (annotated).

- g. **Element 1[f]: wherein the filter layer is transparent to the electromagnetic radiation having the first wavelength spectrum.**

Shiotani discloses this element. Shiotani’s color filter layer 24C (the filter layer) transmits green and blue light, but blocks red light, as illustrated in Figure 8.

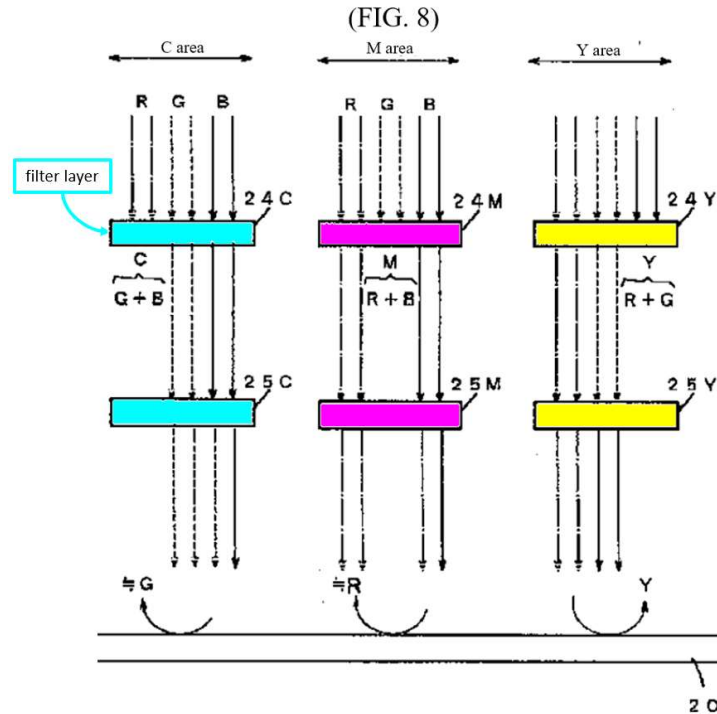

Shiotani, Fig. 8 (annotated).

As discussed with respect to ground I, the term “transparent” describes materials with high optical transmittance. Ex. 1003, ¶198. Shiotani discloses that color filter 24C is transparent to the blue light emitted by the EL light-emitting layer. Shiotani, ¶[0042] (“The G component light and the B component light pass through the C area.”); Ex. 1003, ¶199. Shiotani also discloses that the display can reflect “up to 66%” of incident light. Shiotani, ¶[0044]. As Dr. Eden explains, this means that the filters used in Shiotani’s display, including color filter 24C is highly transmissive, transmitting 80% or more of the incident light. Ex. 1003, ¶200. Shiotani therefore discloses that color filter 24C is transparent to blue light (i.e., the electromagnetic radiation having the first wavelength spectrum). *Id.*

At a minimum, to the extent there were any question whether color filter 24C is “transparent to the electromagnetic radiation having the first wavelength spectrum,” it would have been obvious to use such a transparent filter. As discussed above for Ground 1, transparent color filters were well known in the art and routinely used in OLED displays. *See* Section VII.D.1; Ex. 1003, ¶¶201–02. A POSITA would have been motivated to use such filters to increase the brightness, improve the efficiency, and extend the lifetime of the display. *Id.* A POSITA would have had a reasonable expectation of success in using a transparent filter in Shiotani’s display. Ex. 1003, ¶202. Such filters were commercially available and it would have been a routine matter to replace one color filter with another. *Id.*

2. Dependent Claim 2: The optoelectronic device as claimed in claim 1, wherein the first wavelength spectrum comprises a blue wavelength range and the second wavelength spectrum comprises a yellow wavelength range.

Shiotani teaches or suggests the elements of this claim. According to Shiotani, “the light generated from the EL light-emitting element 3 is blue light.” Shiotani, ¶[0045]. Thus, the spectrum of the electromagnetic radiation emitted by Shiotani’s organic layer sequence (i.e., the first wavelength spectrum) comprises a blue wavelength range. Ex. 1003, ¶204.

Additionally, Shiotani’s “color conversion layer 25Y...converts the B (blue) component light into Y component [i.e., yellow] light.” Shiotani, ¶[0040]. The “color conversion layer 25Y is a mixture of a color conversion layer that converts

the B component light into R component light and a color conversion layer that converts the B component light into G component light to obtain Y, a color mixture of the R and G component light.” Shiotani, ¶[0041]. Thus, Shiotani’s color conversion layer 25Y converts electromagnetic radiation into a second wavelength spectrum that “comprises a yellow wavelength range” for at least two reasons:

First, a POSITA would understand that a “wavelength spectrum comprises a yellow wavelength range” if the light within that spectrum is perceived by an observer to be yellow. Ex. 1003, ¶206. Light having a wavelength between approximately 570 and 590 nm will be perceived as yellow, and certain combinations of red and green light will also be perceived by an observer as yellow light. *Id.* Shiotani’s color conversion layer 25Y produces a spectrum of red and green light that is specifically designed to be perceived as yellow and will be perceived as such. *Id.*

Second, even if the claim were interpreted to require that the second wavelength spectrum comprises electromagnetic radiation with a wavelength between approximately 570 and 590 nm, the wavelength spectrum of Shiotani’s color conversion layer 25Y comprises such a wavelength range. A POSITA would understand that Shiotani’s color conversion layer, which “converts the B component light into G component light,” Shiotani, ¶[0041], would be formed from a phosphor. Ex. 1003, ¶207. Such phosphors have an emission spectrum shaped like a bell curve.

Id. Although the emission peak would correspond to green light, the spectrum also extends into shorter wavelengths and longer wavelengths and includes light between 570 and 590 nm. *Id.*

In the alternative, it would have been obvious to a POSITA to modify Shiotani's color conversion layer 25Y to use a yellow phosphor having an emission spectrum that peaks in the wavelength range between approximately 570 and 590 nm. Phosphors that absorb blue light (such as that produced by Shiotani's EL light-emitting element 3) and emit light between approximately 570 and 590 nm were well-known in the prior art. Ex. 1003, ¶208; *see also* Ex. 1026. Such yellow phosphors were commonly used in electroluminescent devices. Ex. 1003, ¶208. A POSITA would understand that creating Shiotani's color conversion layer 25Y from multiple phosphors would require additional processing steps that could be avoided by using a single yellow phosphor. Ex. 1003, ¶208. A POSITA would therefore have been motivated to use a single yellow phosphor. *Id.* A POSITA would have had a reasonable expectation of success in modifying Shiotani to replace the red and green phosphors used in color conversion layer 25Y with a conventional yellow phosphor. *Id.*

3. Dependent Claim 3: The optoelectronic device as claimed in claim 1, wherein the optoelectronic device has a non-yellow color impression.

Shiotani teaches or suggests the elements of this claim.. As discussed above with respect to Ground I, a POSITA would understand that the claimed “non-yellow color impression” refers to the color impression when the device is turned off.

Shiotani discloses a display comprising yellow, magenta, and cyan pixels. *See* Shiotani, ¶[0039], Fig. 7. A POSITA would understand that to the extent that light is reflected off of these filters, it would combine to produce a gray-white light. Ex. 1003, ¶¶211–12. In addition, “a black mask layer 9 made of resin is formed” between the pixels. Shiotani, ¶[0018], Fig. 7. In fact, a substantial portion of the display is covered by the black matrix, which has the effect of darkening the display to produce a black or dark grey color impression. Ex. 1003, ¶211.

At a minimum, it would have been obvious to manufacture Shiotani’s display to have a non-yellow color impression. Shiotani’s display is a flat panel display. Such displays appear black (or dark grey) when the pixels are off in order to maximize the contrast of the display. Ex. 1003, ¶213. Such displays produce black images by turning off the pixels. *Id.* A display that had a yellow color impression when turned off would be unable to display black. *Id.* Such a display would have a low-contrast appearance and would produce a yellow tint to any image shown on the display. *Id.* A black screen also has the beneficial effects of reducing the amount of

energy required to drive the display and increasing the visibility of the display in ambient lighting. Ex. 1003, ¶213. Therefore, a POSITA would understand that Shiotani's display would appear black when it is off. And it would have been obvious to implement Shiotani's display so that it appears black when it is off, in order to maximize contrast and appear consistent with typical flat panel displays. *Id.*

As discussed above for ground I, the patent Examiner found that this limitation was obvious over Kobori because "it would have been obvious to [a POSITA] to have the display appear black to an observer in order to meet flat panel display appearance expectations." Ex. 1002 (File History) at 513 The Examiner's analysis (which applicants did not dispute) is equally applicable to Shiotani's flat-panel display. *See* Ex. 1003, ¶214.

Even if the claim were interpreted to require a "non-yellow color impression" when the device is turned on, it would still be satisfied or obvious over Shiotani. A POSITA would understand that Shiotani's display would have a non-yellow color impression when turned on. Ex. 1003, ¶215. Shiotani's display is designed to produce images from a wide range of colors. Shiotani, ¶[0053]. In particular, a "white display is possible through mixing of the color components Y, M, and C." *Id.*, ¶[0045]. Therefore, Shiotani's display has a non-yellow color impression.

- 4. Dependent Claim 4: The optoelectronic device as claimed in claim 1, wherein the filter layer is configured to convert the electromagnetic radiation having the third wavelength spectrum into an electromagnetic radiation from a non-visible wavelength range.**

Claim 4 would have been obvious to a POSITA based on Shiotani. As discussed above with respect to ground I, the '547 patent explains that this limitation is satisfied by a filter layer that absorbs light in the third wavelength spectrum, because absorbed light is converted “into heat or thermal radiation,” which is “electromagnetic radiation from a non-visible wavelength range.” '547 patent, 3:46–65.

Shiotani discloses that color filter layer 24C (the filter layer) “transmits only the C component” (cyan light) by transmitting green and blue light while blocking red light, as illustrated in Figure 8. Shiotani, ¶[0040]; Ex. 1003, ¶219. Shiotani further discloses that the color filters absorb light that is not transmitted. Ex. 1003, ¶220. For example, in the embodiment of Figure 1:

The color filter layer 7R transmits light in the red wavelength region and *absorbs light in other wavelength regions ...*, the color filter layer 7G transmits light in the green wavelength region and *absorbs light in other wavelength regions ...*, and the color filter layer 7B transmits light in the blue wavelength region and *absorbs light in other wavelength regions....*

Shiotani, ¶[0018]; *see also id.*, ¶¶[0028], [0004].

A POSITA would understand that Shiotani's cyan color filter layer 24C would absorb the light that it does not transmit—i.e., red light. Ex. 1003, ¶221. At a minimum, it would have been obvious to use a cyan color filter that operates the same way as Shiotani's red, green, and blue color filters, which absorb the light components that are not transmitted through the filters. *Id.* Thus, it would have been obvious for Shiotani's filter layer to be configured to absorb red light—i.e., the electromagnetic radiation having a third wavelength spectrum.

When the filter layer absorbs red light, the absorbed light is converted into electromagnetic radiation from a non-visible wavelength range, namely heat or infrared radiation. Ex. 1003, ¶222. Therefore, it would have been obvious for Shiotani's color filter layer 24C “configured to convert the electromagnetic radiation having the third wavelength spectrum” (red light) “into an electromagnetic radiation from a non-visible wavelength range” (infrared radiation). Ex. 1003, ¶223.

5. Dependent Claim 5: The optoelectronic device as claimed in claim 4, wherein the filter layer is further configured to absorb the electromagnetic radiation having the third wavelength spectrum.

Claim 5 would have been obvious based on Shiotani. As discussed above for Claim 4, it would have been obvious for Shiotani's filter layer (color filter layer 24C) to be “configured to absorb the electromagnetic radiation having the third wavelength spectrum” (red light).

6. Dependent Claim 8

- a. The optoelectronic device as claimed in claim 1, wherein the first regions each have a second filter layer disposed downstream of the wavelength conversion layer in the beam path of the electromagnetic radiation emitted by the organic layer sequence and**

Shiotani teaches or suggests this element. Each yellow pixel includes a color filter layer 24Y, which is the claimed “second filter layer.” See Shiotani, ¶[0040]. As shown in Figure 7, below, color filter layers 24Y are included in the “first regions.”

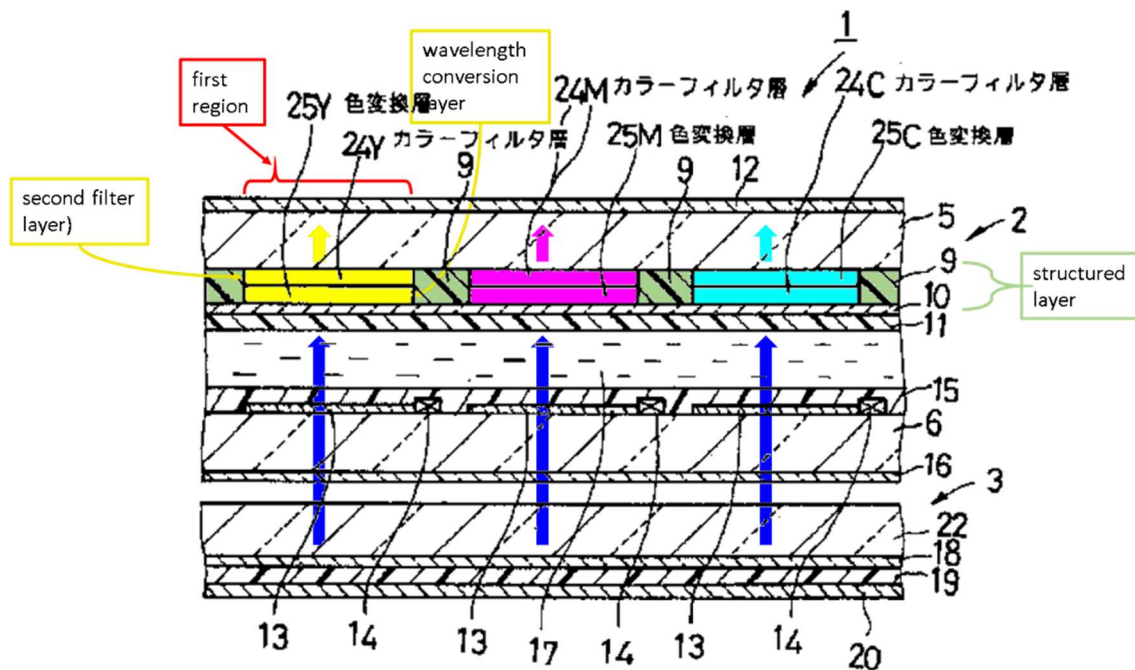

Shiotani, Fig. 7 (annotated).

Color filter layer 24Y is “disposed downstream of the wavelength conversion layer” (color conversion layer 25 Y) “in the beam path of the electromagnetic radiation emitted by the organic layer sequence” (EL light-emitting layer 19), as

shown above. Ex. 1003, ¶¶225–26. As explained for Element 1[c], the light-emitting element serves as a “backlight of the liquid crystal cell 2,” Shiotani, ¶[0028], and emits light through the structured layer’s color conversion layers 25Y, 25M, and 25C and color filter layers 24Y, 24M, and 24C, *id.*, ¶[0045].

- b. which is at least partially opaque to an electromagnetic radiation having a fourth wavelength spectrum which corresponds to at least one part of the first wavelength spectrum.**

Shiotani teaches or suggests this element. Shiotani explains that “color filter layer 24Y...transmits only the Y component” (i.e., yellow light). Shiotani, ¶[0040]. It does so by transmitting red and green light, but not blue light, as illustrated in Figure 8:

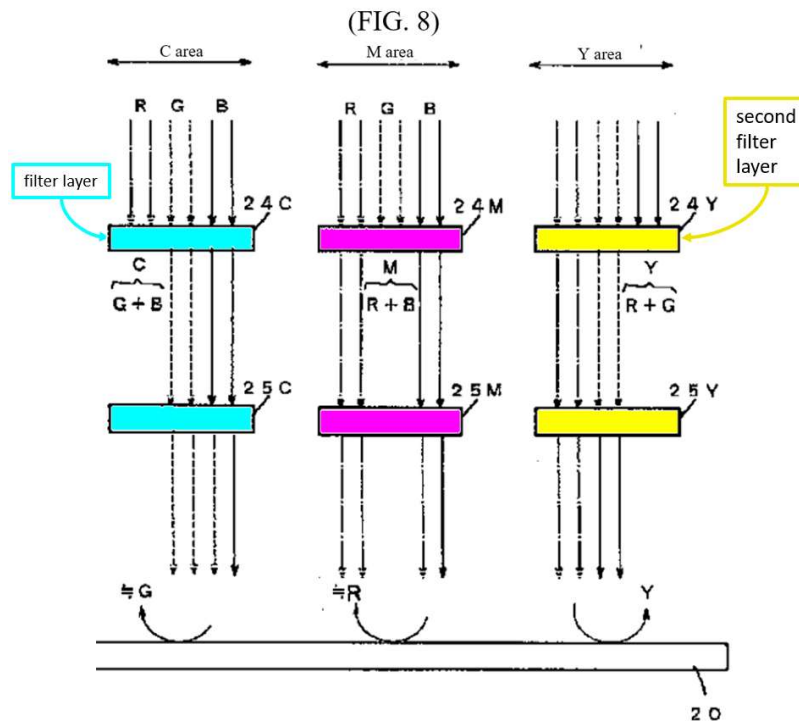

Shiotani, Fig. 8 (annotated); *see id.*, ¶[0042] (“R component light (single-dotted lines) and G component light (dashed lines) pass through in the Y area.”). As can be seen in Figure 8, color filter layer 24Y is at least partially opaque to blue light.

Therefore, color filter layer 24Y constitutes a second filter layer that is “at least partially opaque to an electromagnetic radiation having a fourth wavelength spectrum” (blue light) “which corresponds to at least one part of the first wavelength spectrum” (light from EL light-emitting layer 19). Ex. 1003, ¶¶230–33.

7. Dependent Claim 9: The optoelectronic device as claimed in claim 8, wherein the second filter layer is configured at least partially to absorb the electromagnetic radiation having the fourth wavelength spectrum.

Claim 9 would have been obvious to a POSITA based on Shiotani. As discussed above for Claim 8, color filter layer 24Y is the claimed “second filter layer” and is at least partially opaque to the fourth wavelength spectrum comprising blue light. As discussed above with respect to claim 5, Shiotani discloses that each of its red, green, and blue color filters at least partially absorb the light components that are not transmitted through the filters. Shiotani, ¶¶[0004], [0018], [0028]; *see* Ex. 1003, ¶234.

Because Shiotani’s yellow color filter layer 24Y transmits red and green light, but not blue light, a POSITA would understand that yellow color filter layer 24Y at least partially absorbs blue light. Ex. 1003, ¶234. At a minimum, it would have been obvious to use a yellow color filter that operates the same way as Shiotani’s red,

green, and blue color filters, which at least partially absorb the light components that are not transmitted through the filters. *Id.* Thus, it would have been obvious for Shiotani's filter layer to be "configured at least partially to absorb the electromagnetic radiation having the fourth wavelength spectrum" (blue light).

8. Dependent Claim 10: The optoelectronic device as claimed in claim 8, wherein the second filter layer is configured at least partially to reflect the electromagnetic radiation having the fourth wavelength spectrum.

Claim 10 would have been obvious to a POSITA based on Shiotani. As discussed above for claims 8 and 9, a POSITA would understand that Shiotani's yellow color filter layer 24Y (the claimed "second filter layer") is at least partially opaque to blue light (the claimed "electromagnetic radiation having a fourth wavelength spectrum"). It would have been obvious for color filter layer 24Y to be "configured at least partially to reflect" such light. Ex. 1003, ¶¶235–37.

As discussed above with respect to ground I, a POSITA would understand that color filters reflect a portion of the incident electromagnetic radiation because, when a beam of radiation strikes an interface between two different transparent media, some light will be reflected. Ex. 1003, ¶236; *see, e.g.*, Hecht (Ex. 1014) at 95; Mourad (Ex. 1015) at 15.

A portion of the light incident on color filter layer 24Y will be reflected back toward the organic electroluminescent element 12 (rather than passing into the color filter). Ex. 1003, ¶237. This reflected light will comprise blue light from Shiotani's

organic electroluminescent element, given that the color conversion layer 25Y will not convert fully 100% of the blue light to red and green light. *Id.* Thus, a POSITA would understand that Shiotani's color filter layer 24Y is "configured at least partially to reflect the electromagnetic radiation having the fourth wavelength spectrum" (blue light). At a minimum, this would have been obvious, as such reflection is characteristic of color filters.

Indeed, as discussed above for ground I, the Examiner used this same rationale for finding that this claim element was disclosed in the display of Kobori, explaining that "the interface between [Kobori's] layers 23 and 22G will characteristically reflect some of the electromagnetic radiation emitted by the organic layer sequence." Ex. 1002 (File History) at 509. That is, in Kobori, some of the radiation from the organic layer sequence is reflected at the interface between the wavelength conversion layer (Kobori's green fluorescence conversion layer 23) and second filter layer (Kobori's green filter layer 22G). The Examiner's analysis (which the applicants did not dispute) is equally applicable for Shiotani, in which some radiation from the organic layer sequence is similarly reflected at the interface between color conversion layer 25Y color filter layer 24Y. *See* Ex. 1003, ¶238.

9. Dependent Claim 13: The optoelectronic device as claimed in claim 1, wherein the electromagnetic radiation which is emitted by the optoelectronic device corresponds to a superimposition of the electromagnetic radiation having the first wavelength spectrum and the electromagnetic radiation having the second wavelength spectrum.

Shiotani teaches or suggests the elements of this claim. Shiotani's display device comprises cyan, magenta, and yellow pixels. *See* Shiotani, ¶[0039], Fig. 7. Shiotani discloses that the display is capable of reproducing a wide range of different colors by combining light from the different pixels:

[T]he colors of each pixel can be mixed and displayed by modulating the electric field of the liquid crystal cell 2. In particular, a wide chromaticity range can be achieved by controlling the gradation of each color.

Shiotani, ¶[0031]. Shiotani further discloses that a "white display is possible through mixing of the color components Y, M, and C." *Id.*, ¶[0045].

A POSITA would understand that white light is produced by the superimposition of different colors of light obtained by activating the yellow, magenta, and cyan pixels simultaneously. Ex. 1003, ¶241. Therefore, when displaying a white image, the light emitted by Shiotani's display would comprise a superimposition of the electromagnetic radiation from all three pixels. *Id.* In particular, the light from the cyan pixel includes "unconverted light (transmitted light) B," which is electromagnetic radiation having the first wavelength spectrum.

Id. The light from the yellow pixel is electromagnetic radiation having the second wavelength spectrum. *Id.*

Therefore white light, or indeed any color formed by simultaneously activating the cyan and yellow pixels, would emit light corresponding to a superposition of the electromagnetic radiation having the first wavelength spectrum and the electromagnetic radiation having the second wavelength spectrum.

At a minimum, it would have been obvious to use Shiotani's display to produce white light corresponding to a superimposition of the electromagnetic radiation having the first wavelength spectrum (blue light from the cyan pixels) and the electromagnetic radiation having the second wavelength spectrum (yellow light from the yellow pixels). Ex. 1003, ¶245; *see also* Murdoch (Ex. 1016), 1:17–23 (“These light emitting color primaries define a color gamut, and by additively combining the illumination from each of these three OLEDs, i.e. with the integrative capabilities of the human visual system, a wide variety of colors can be achieved.”).

E. Ground V: Claims 11 and 12 Are Obvious Based on Shiotani and Pilcher

- 1. Dependent Claim 11: The optoelectronic device as claimed in claim 1, further comprising an encapsulation one of disposed upstream and disposed downstream of the structured layer in the beam path of the electromagnetic radiation emitted by the organic layer sequence.**

Claim 11 would have been obvious over Shiotani in light of Pilcher. A POSITA would have understood that it would have been necessary to encapsulate

Shiotani's EL light-emitting element 3. Ex. 1003, ¶¶246–47. The EL light-emitting element is an OLED “formed by sequentially laminating a front electrode 18 made of transparent ITO, an organic EL light-emitting layer 19, and a light-reflective rear electrode 20 across the entire display region on the rear surface of an EL substrate 22 made of transparent glass.” Shiotani, ¶[0021]. The materials used in an OLED, including both ITO and the organic materials in layer 19, are highly reactive to oxygen and atmospheric moisture. Ex. 1003, ¶246. Without encapsulation, these materials begin to degrade within hours, which would render Shiotani's display unsuitable for most practical applications. *Id.*, ¶247 Shiotani itself recognizes the need to protect the OLED from exposure, disclosing that “rear electrode 20 is preferably covered with a protective film to prevent oxidation.” Shiotani, ¶[0023].

By the time of the '547 patent, thin-film encapsulation was well-established and would have been well-known to a POSITA. Ex. 1003, ¶248. As described in Pilcher, in thin-film encapsulation, “[a] glass (or other suitable material) substrate 102 provides the support structure for OLED structure” and multiple thin-film layers “comprising alternating and repeating layers of an organic (usually acrylate or the like) and a barrier layer” are deposited over the OLED structure. Pilcher, 1:21–25.

As discussed above with respect to Ground 2, thin-film encapsulation was known to provide a number of advantages over alternative encapsulations, including “cost reduction and improved reliability.” Pilcher, 1:48–50; *see also* Ex. 1003, ¶249.

Pilcher explains that “[u]sing direct thin-film encapsulation, the package may also be thinner and/or lighter and/or mechanically more flexible. Several structures and steps of the prior art may be excluded with this process. For example, there is no need for a separate glass plate, no need for an epoxy seal, no need for a getter (which is typical in the prior art).” *Id.*, 1:50–55. For these reasons, a POSITA would have been motivated to use thin-film encapsulation to protect Shiotani’s EL light-emitting element 3 from degrading and to extend the life of the display. Ex. 1003, ¶250.

A POSITA also would have had a reasonable expectation of success in using such encapsulation in Shiotani. *Id.* Encapsulation was extensively used in OLED devices and the techniques for encapsulation were well-known to a POSITA. *Id.* In addition, Shiotani already includes some of the elements required for encapsulation. For example, Shiotani discloses that the OLEDs are formed on “an EL substrate 22 made of transparent glass.” Shiotani, ¶[0021]. Shiotani also already discloses “a protective film to prevent oxidation” of the materials used in the OLED. Shiotani, ¶[0023]. A POSITA would have been readily able to implement thin-film encapsulation in Shiotani by adding the organic and barrier layers disclosed in Pilcher to better protect the reactive materials in Shiotani’s EL light-emitting element. Ex. 1003, ¶253.

Furthermore, it would have been obvious for the encapsulation to be “disposed upstream...of the structured layer in the beam path of the electromagnetic

radiation emitted by the organic layer sequence.” Although Figure 7 shows one embodiment in which substrate 22 is in the beam path of the radiation emitted by organic EL light-emitting layer 19, Shiotani explicitly states the substrate “may of course be provided on the rear side of the rear electrode 20.” Shiotani, ¶[0052]. In this configuration, the encapsulation is deposited over front electrode 18 and therefore disposed both “in the beam path of the electromagnetic radiation emitted” and “upstream” of the structured layer. Ex. 1003, ¶252.

2. Dependent Claim 12

- a. The optoelectronic device as claimed in claim 11, wherein the encapsulation comprises a thin-film encapsulation.**

This dependent claim would have been obvious to a POSITA over Shiotani in light of Pilcher. As discussed above for Claim 11, it would have been obvious to a POSITA to encapsulate the organic light emitting diodes in order “to protect the OLED device from the damaging environmental effects—primarily from oxygen and moisture.” Pilcher, 1:8–10. Moreover, thin-film encapsulation would have been obvious based on its numerous advantages, including “cost reduction and improved reliability.” *Id.*, 1:48–49; Ex. 1003, ¶254.

F. Ground VI: Claim 14 Is Obvious Based on Shiotani and Dresevic

1. Dependent Claim 14

- a. The optoelectronic device as claimed in claim 1, wherein the structured layer has at least one of striped, crossed-striped, circular, triangular, and rectangular regions.**

Claim 14 would have been obvious based on Shiotani and Dresevic. In particular, it would have been obvious for Shiotani's structured layer to have striped and rectangular regions. In Shiotani's display device, the shape of the "first regions" and the "second regions" correspond to the shapes of the yellow and cyan pixels, respectively. Ex. 1003, ¶255. Although Shiotani does not explicitly state that the pixels are rectangular, it would have been obvious to a POSITA that the pixels in Shiotani's display would be rectangular and that the structured layer would therefore have striped or rectangular regions. *Id.*

A POSITA would understand that Shiotani's display device includes many pixels of each color. Shiotani discloses that the pixels are arranged in a "matrix," i.e., in rows and columns. Shiotani, ¶[0019]. As discussed above with respect to ground III, a POSITA would understand that the pixels in an OLED display were usually rectangular and were "commonly arranged to form stripes along the display." Dresevic, 2:3–13; *see also* Ex. 1003, ¶¶256–57; Murdoch (Ex. 1016), 4:28–29, 12:3–5. Figure 1 of Dresevic illustrates this arrangement:

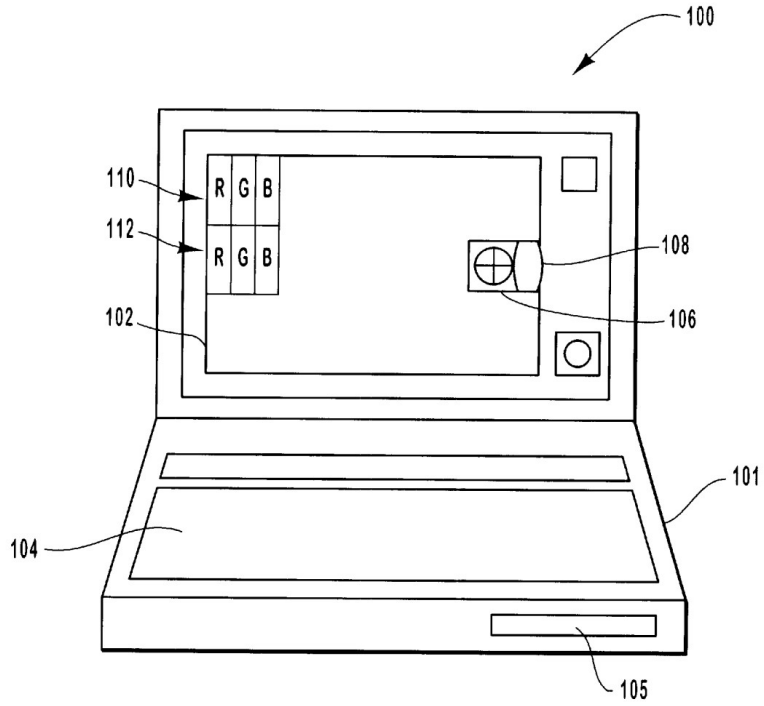

Drešević, Fig. 1. In the context of Shiotani, which uses yellow, magenta, and cyan pixels, this striping would take the form of a YMC striped arrangement, as shown in the following demonstrative:

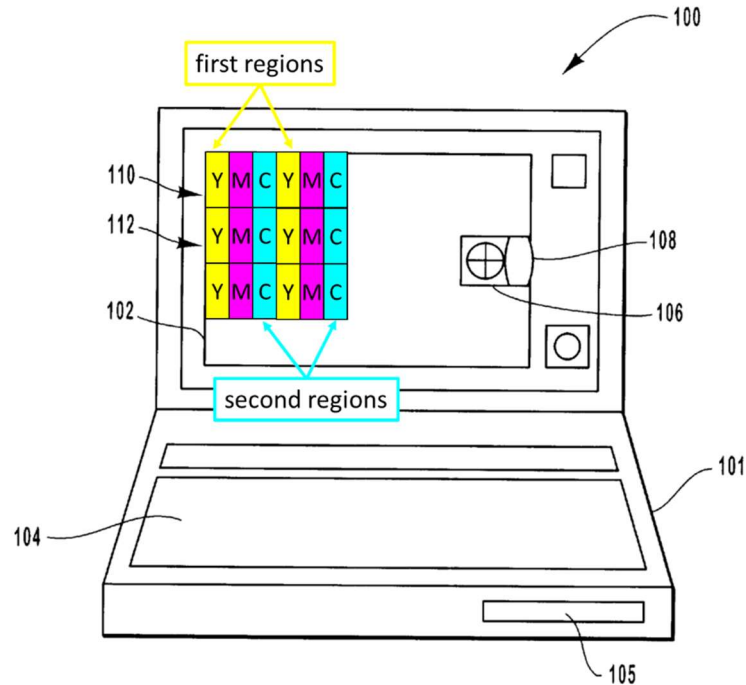

Ex. 1003, ¶258. This would result in Shiotani’s structured layer having first regions (areas of yellow pixels) and second regions (areas of cyan pixels) that are striped and rectangular, as illustrated above.

Indeed, as discussed above for ground III the Examiner found that this claim element would have been obvious based on Krummacher—explaining that although Krummacher “is silent as to a specific shape” of the pixels, “it would have been obvious to one of ordinary skill in the art to have the structured layer have the shapes be rectangular in order to provide a pixelated appearance.” Ex. 1002 (File History) at 512. The Examiner’s analysis (which the applicants did not dispute) is likewise applicable for Shiotani. *See* Ex. 1003, ¶260. As is evident from Dresevic Figure 1 as well as Murdoch Figure 6a, it was common for flat panel displays to have rectangular

pixels. Thus, it would have been obvious for Shiotani's structured layer to have rectangular regions in order for Shiotani's display to have a pixelated appearance that is consistent with other such flat-panel displays.

IX. DISCRETIONARY DENIAL IS INAPPROPRIATE UNDER *FINTIV*

The Board should decline to exercise its discretion to deny institution under 35 U.S.C. § 314(a) and *Apple Inc. v. Fintiv, Inc.*, IPR2020-0019, Paper 11 (P.T.A.B. Mar. 20, 2020) (precedential). While the '547 patent has been asserted in *Pictiva Displays International Ltd. v. Samsung Electronics Co., Ltd., et al.*, Case No. 2:23-cv-00495 (E.D. Texas), that case remains in a very early stage. Infringement contentions were served on March 11, 2024. The court issued its initial scheduling order on April 17, 2024, scheduling a trial for August 2025. *See* Ex. 1029 (Docket Control Order).

Accordingly, the parties have made no material investments in the parallel litigation. No discovery has taken place beyond initial disclosures, and the claim construction process has not even begun. Additionally, this Petition is being filed less than two months after service of infringement contentions, demonstrating that Petitioner has acted with diligence in preparing its patent challenge. Finally, Patent Owner will need to narrow the asserted claims in advance of any trial, *see* Ex. 1029 at 1, such that a trial could not resolve all of Petitioner's claim challenges. Discretionary denial is further inappropriate because this Petition presents

compelling evidence of unpatentability, for the reasons discussed in Section VIII, above.

X. CONCLUSION

Petitioner respectfully requests *inter partes* review and cancellation of claims 1–5 and 8–14 of the '547 patent.

Date: May 7, 2024

Respectfully submitted,

By /David A. Garr/

David A. Garr

Registration No.: 74,932

COVINGTON & BURLING LLP

One CityCenter, 850 Tenth Street, NW

Washington, DC 20001

Scott C. Weidenfeller

Registration No.: Reg. No. 54,531

COVINGTON & BURLING LLP

One CityCenter, 850 Tenth Street, NW

Washington, DC 20001

CERTIFICATION UNDER 37 C.F.R. § 42.24(D)

I certify that the foregoing complies with the type-volume limitation of 37 C.F.R. § 42.24 and contains 13,844 words based on the word count indicated by the word-processing system used to prepare the paper, and excluding those portions exempted by § 42.24(a).

Date: May 7, 2024

/David A. Garr/
David A. Garr (Reg. No. 74,932)

CERTIFICATE OF SERVICE

Pursuant to 37 C.F.R. §§ 42.6 and 42.105, I hereby certify that on May 7, 2024, I caused a true and correct copy of the foregoing Petition for *Inter Partes* Review of U.S. Patent No. 8,314,547, supporting exhibits, and Power of Attorney to be served via Priority Mail Express on the Patent Owner at the following correspondence address of record as listed on the USPTO Patent Center:

COZEN O'CONNOR
3WTC, 175 Greenwich Street
55th Floor
New York, NY 10007
Customer # 27799

A courtesy copy was also served via electronic mail on Patent Owner's counsel of record in District Court matter:

Samuel F. Baxter
Jennifer L. Truelove
MCKOOL SMITH, P.C.
104 East Houston Street Suite 300
Marshall, TX 75670
sbaxter@mckoolsmith.com
jtruelove@mckoolsmith.com

Jason G. Sheasby
Annita Zhong, PhD
IRELL & MANELLA LLP
1800 Avenue of the Stars, Suite 900
Los Angeles, CA 90067
jsheasby@irell.com
hzhong@irell.com

Philip Warrick
IRELL & MANELLA LLP
750 17th Street NW, Suite 850
Washington, DC 20006
pwarrick@irell.com

Rebecca Carson
Jie Gao
IRELL & MANELLA LLP
840 Newport Center Drive, Suite 400
Newport Beach, CA 92660
rcarson@irell.com
jgao@irell.com

Petition for *Inter Partes* Review of U.S. Patent No. 8,314,547

Date: May 7, 2024

/David A. Garr/
David A. Garr (Reg. No. 74,932)