

IN THE UNITED STATES PATENT AND TRADEMARK OFFICE

BEFORE THE PATENT TRIAL AND APPEAL BOARD

AMAZON.COM, INC., AMAZON.COM SERVICES LLC,

Petitioner,

v.

NOKIA TECHNOLOGIES OY,

Patent Owner.

IPR2024-01505

U.S. Patent No. 9,571,833

PETITION FOR *INTER PARTES* REVIEW

OF U.S. PATENT NO. 9,571,833

TABLE OF CONTENTS

	<u>Page</u>
EXHIBIT LIST	1
I. BACKGROUND	6
A. Motion Prediction Basics	6
B. H.264 to H.265	10
II. '833 PATENT.....	12
A. Prosecution History	12
B. Priority Date	13
III. IDENTIFICATION OF CHALLENGE.....	13
A. Statutory Grounds.....	13
B. Relied-Upon Prior Art.....	14
1. Ruserf (Ex-1004).....	14
2. Zheng (Ex-1005).....	15
3. Nakamura (Ex-1007 through Ex-1009) and WD4 (Ex-1010)	16
C. Standing.....	18
IV. LEVEL OF ORDINARY SKILL IN THE ART.....	19
V. CLAIM CONSTRUCTION	19
A. “spatial motion vector prediction candidate”.....	19
B. “temporal motion prediction candidate”	20
C. “the block”	20
D. “a subset of ... candidates”	20
VI. CHALLENGED CLAIMS	21
A. Ground 1:.....	21
1. Motivation to Combine	21
2. Claim 1	27
3. Claim 2.....	48
4. Claim 3	48

5.	Claim 4.....	49
6.	Claim 5.....	53
7.	Claim 6.....	55
8.	Claim 7.....	61
9.	Claim 8.....	61
10.	Claims 15 and 17.....	62
11.	Claims 19-25.....	63
B.	Ground 2:.....	63
1.	Motivation to Combine.....	63
2.	Claim 1.....	66
3.	Claim 2.....	77
4.	Claim 3.....	78
5.	Claim 4.....	79
6.	Claim 5.....	81
7.	Claim 6.....	82
8.	Claim 7.....	86
9.	Claim 8.....	87
10.	Claims 15 and 17.....	88
11.	Claims 19-25.....	89
VII.	DISCRETIONARY ANALYSIS.....	89
VIII.	MANDATORY NOTICES AND FEES.....	92
	CLAIM APPENDIX.....	95

EXHIBIT LIST

Exhibit No.	Description
1001	U.S. Patent No. 9,571,833 to Bici, et al. (“the ’833 patent”)
1002	Certified Prosecution File History for the ’833 patent (“Prosecution History”)
1003	Declaration of Charles Creusere (“Creusere Declaration”)
1004	U.S. Patent Application Publication No. 2011/0194609 to Rusert et al. (“Rusert”)
1005	U.S. Patent Application Publication No. 2013/0077691 to Zheng et al. (“Zheng”)
1006	U.S. Patent Application Publication No. 2014/0092981 to Lin et al. (“Lin”)
1007	Nakamura et al., “Unification of derivation process for merge mode and MVP,” Joint Collaborative Team on Video Coding (JCT-VC) of ITU-T SG16 WP3 and ISO/IEC JTC1/SC29/WG11, 6th Meeting, Torino, Italy, Jul. 14-22, 2011, Document JCTVC-F419 (“Nakamura Document”)
1008	Nakamura et al., “WD description of JCTVC-F419 Proposal 1” for “Unification of derivation process for merge mode and MVP,” Joint Collaborative Team on Video Coding (JCT-VC) of ITU-T SG16 WP3 and ISO/IEC JTC1/SC29/WG11, 6th Meeting, Torino, Italy, Jul. 14-22, 2011, Document JCTVC-F419 (“Nakamura WD Description”)
1009	Nakamura et al., “Unification of derivation process for merge mode and MVP” Presentation, Joint Collaborative Team on Video Coding (JCT-VC) of ITU-T SG16 WP3 and ISO/IEC JTC1/SC29/WG11, 6th Meeting, Torino, Italy, Jul. 14-22, 2011, Document JCTVC-F419 (“Nakamura Presentation”)
1010	Bross et al., “WD4: Working Draft 4 of High-Efficiency Video Coding,” Joint Collaborative Team on Video Coding (JCT-VC) of ITU-T SG16 WP3 and ISO/IEC JTC1/SC29/WG11, 6th Meeting: Torino, IT, Jul. 14-22, 2011, Document JCTVC-F803 (“WD4”)
1011	U.S. Patent Application Publication No. 2011/0249721 to Karczewicz et al (“Karczewicz”)
1012	U.S. Provisional Application 61/301,649 (“Rusert Provisional”)
1013	INTENTIONALLY LEFT BLANK
1014	Declaration of Vivienne Sze (“Sze Declaration”)

Exhibit No.	Description
1015	Prosecution File History for U.S. Patent No. 9,571,714 (“714 Prosecution File History”)
1016	Prosecution File History for U.S. Patent No. 9,743,105 (“105 Prosecution File History”)
1017	European Prosecution File History for 12845839 (“European Prosecution History”)
1018	U.S. Patent Application Publication No. 2012/0128067 to Liu (“Liu”)
1019	Gary J. Sullivan, Recent Developments in Standardization of High Efficiency Video Coding (HEVC) (“Sullivan”)
1020	Frank Bossen, HEVC Complexity and Implementation Analysis (“Bossen”)
1021	Jian-Wei Chen et al, Introduction to H.264 advanced video coding. In: Proceedings of the 2006 Asia and South Pacific Design Automation Conference vol. 2006, pp. 736–741 (2006)
1022	Won, Kwanghyun et al, Motion vector coding using decoder-side estimation of motion vector. In 2009 IEEE International Symposium on Broadband Multimedia Systems and Broadcasting (BMSB). IEEE, 2009.
1023	Gary J. Sullivan et al, The H.264/AVC Advanced Video Coding Standard: Overview and Introduction to the Fidelity Range Extensions, SPIE Conference on Applications of Digital Image Processing XXVII, 2004.
1024	Gweon, Ryeong-Hee, Non-Fixed Quantization Considering Entropy Encoding in HEVC, Journal of Broadcast Engineering. The Korean Institute of Broadcast and Media Engineers, 2011
1025	Hong, Chang-Yi, New Merge Mode Decision in High Efficiency Video Coding (HEVC), 2014 International Computer Science and Engineering Conference (ICSEC), IEEE (2014).
1026	JCT-VC - Joint Collaborative Team on Video Coding (https://www.itu.int/en/ITU-T/studygroups/2013-2016/16/Pages/video/jctvc.aspx)
1027	Terms of Reference of the Joint Collaborative Team on Video Coding Standard Development (https://www.itu.int/dms_pub/itu-t/oth/46/01/T46010000010001PDFE.pdf)

Exhibit No.	Description
1028	Sullivan et al., “Meeting report of the sixth meeting of the Joint Collaborative Team on Video Coding (JCT-VC), Torino, IT, 14–22 July 2011,” Joint Collaborative Team on Video Coding (JCT-VC) of ITU-T SG16 WP3 and ISO/IEC JTC1/SC29/WG11, 6th Meeting, Torino, Italy, Jul. 14-22, 2011, Document JCTVC-F800
1029	“All Meetings” web page (from the JCT-VC site) (http://phenix.int-evry.fr/jct/doc_end_user/all_meeting.php)
1030	“Torino Meeting - Document Register” web page (from the JCT-VC site) (http://phenix.int-evry.fr/jct/doc_end_user/current_meeting.php?id_meeting=149&search_id_group=1&search_sub_group=1)
1031	A portion of search screen for “merge mode” on the “Torino Meeting - Document Register” web page
1032	A portion of search screen for “MVP” on the “Torino Meeting - Document Register” web page
1033	Search result page for “merge mode” originated from the “Torino Meeting - Document Register” web page
1034	Search result page for “MVP” originated from the “Torino Meeting - Document Register” web page
1035	Search result page for “WD4” originated from the “Torino Meeting - Document Register” web page
1036	Search result page for “high-efficiency video coding” originated from the “Torino Meeting - Document Register” web page
1037	Search result page for “DRAFT” originated from the “Torino Meeting - Document Register” web page
1038	“Preview document JCTVC-F419 for Torino meeting” web page (http://phenix.int-evry.fr/jct/doc_end_user/current_document.php?id=2894)
1039	“Preview document JCTVC-F803 for Torino meeting” web page (http://phenix.int-evry.fr/jct/doc_end_user/current_document.php?id=3286)
1040	Sullivan et al., “Meeting report of the third meeting of the Joint Collaborative Team on Video Coding (JCT-VC), Guangzhou, CN, 7–15 October, 2010,” Joint Collaborative Team on Video Coding (JCT-VC) of ITU-T SG16 WP3 and ISO/IEC JTC1/SC29/WG11, 3rd Meeting, Guangzhou China, Oct. 7-15, 2010, Document JCTVC-C400

Exhibit No.	Description
1041	“All Meetings” web page (from the JCT-VC distribution website) (http://phenix.int-evry.fr/jct/doc_end_user/all_meeting.php)
1042	“Torino Meeting - Document Register” web page (from the JCT-VC distribution website) (http://phenix.int-evry.fr/jct/doc_end_user/current_meeting.php?id_meeting=149&search_id_group=1&search_sub_group=1)
1043	Search result page for “merge mode” originated from the “Torino Meeting - Document Register” web page (from the JCT-VC distribution website)
1044	Search result page for “MVP” originated from the “Torino Meeting - Document Register” web page (from the JCT-VC distribution website)
1045	Search result page for “WD4” originated from the “Torino Meeting - Document Register” web page (from the JCT-VC distribution website)
1046	Search result page for “WD” originated from the “Torino Meeting - Document Register” web page (from the JCT-VC distribution website)
1047	“Preview document JCTVC-F419 for Torino meeting” web page (http://phenix.int-evry.fr/jct/doc_end_user/current_document.php?id=2894)
1048	“Preview document JCTVC-F803 for Torino meeting” web page (http://phenix.int-evry.fr/jct/doc_end_user/current_document.php?id=3286)
1049	Search result page for “Nakamura” originated from the “Torino Meeting - Document Register” web page (from the JCT-VC distribution website)
1050	Declaration of Clifford Reader
1051	Machine translation of Gweon, Ryeong-Hee, Non-Fixed Quantization Considering Entropy Encoding in HEVC, Journal of Broadcast Engineering. The Korean Institute of Broadcast and Media Engineers, 2011
1052	Prosecution File History for U.S. Patent No. 10,237,574 (“574 Prosecution File History”)
1053	Prosecution File History for U.S. Patent No. 11,570,467 (“467 Prosecution File History”)

Exhibit No.	Description
1054	U.S. Provisional Application 61/499,112 (“Zheng ’112 Provisional”)
1055	U.S. Provisional Application 61/543,043 (“Zheng ’043 Provisional”)
1056	U.S. Provisional Application 61/543,059 (“Zheng ’059 Provisional”)
1057	U.S. Provisional Application 61/556,761 (“Zheng ’761 Provisional”)
1058	U.S. Provisional Application 61/562,387 (“Zheng ’387 Provisional”)
1059	U.S. Provisional Application 61/562,953 (“Zheng ’953 Provisional”)
1060	Oudin, S., et al., Block Merging for Quadtree-Based Video Coding. In 2011 IEEE International Conference on Multimedia and Expo. IEEE, July 11-15, 2011.
1061	U.S. Patent No. 9,313,494 to Zheng et al. (“Zheng-Issued”)
1062	Prosecution File History for U.S. Patent No. 9,313,494 (“Zheng-Issued File History”)

The '833 patent purports to improve on de-duplicating lists of motion vector prediction candidates by comparing subsets of candidates rather than all possible pairs. However, its alleged improvement was already known from the predecessor standard H.264 (Ground 1) and proposed by others during the H.265 standardization process (Ground 2).

The '833 patent is the ultimate parent of the '714 patent that was challenged in IPR2024-00604 and IPR2024-00605. The '833 claims are similar but specifically recite a “merge list,” which had already been included in prior H.265 working drafts and taught by prior art, such as Zheng.

I. BACKGROUND

A. Motion Prediction Basics

Since the 1990s, video-coding standards have applied motion prediction to blocks (e.g., 8x8 pixel squares) in a video frame. Ex-1023, 000004, Figs. 1-2. This technique used motion vectors to describe the movement of blocks between frames. Ex-1021, 000002.¹

¹ All emphasis/annotations added unless stated otherwise.

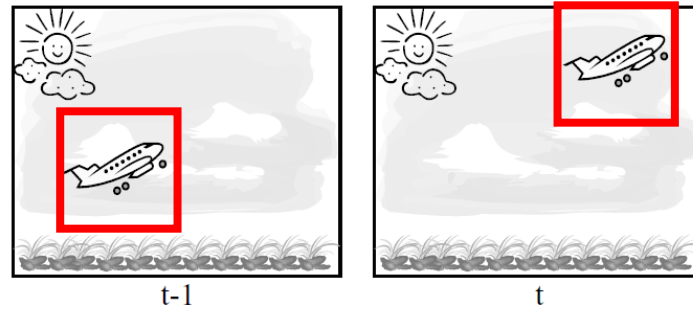
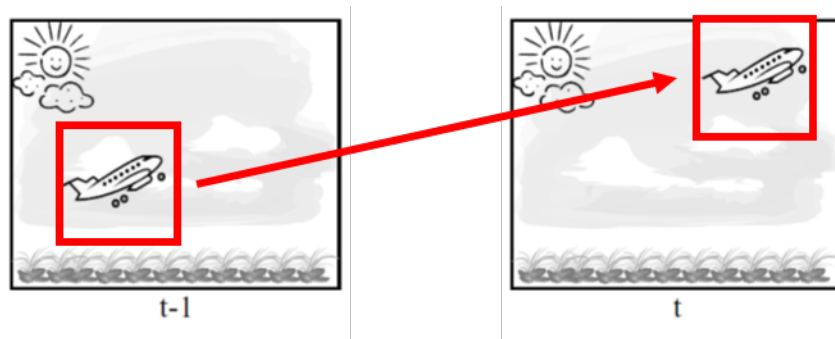

Fig. 3. Successive video frames

Instead of transmitting an entire block of pixels, an encoder signaled a motion vector, used by the decoder to locate the current block in a previously-coded frame (e.g., showing the airplane). The decoder then copied the pixels to the current block, thus eliminating the need for those pixels to be resent by the encoder.

Ex-1021, 000002-4; Ex-1022, 000001-3; Ex-1003, ¶¶3-8.



Many video-coding standards, including H.264, further reduced size of by predicting motion vectors for a current block using motion vectors from prior blocks, and sending the difference between the predicted motion vector (“PMV”) or motion vector predictor (“MVP”) and the actual motion vector. This difference was typically smaller than the full motion vector and required fewer bits. Since the encoder and decoder independently calculated the PMV, only the difference vector

was transmitted, and the decoder calculated the actual motion vector by adding the PMV to the difference vector. Ex-1022, 000001-2.

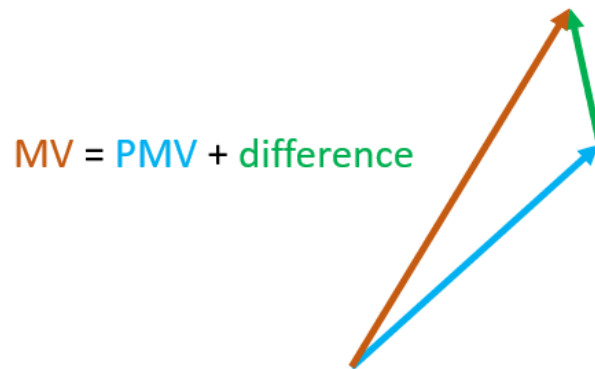

Ex-1003, ¶9.

By 2010, neighboring blocks in the same frame were commonly used to find PMV candidates. Candidates from the same frame were called spatial motion vector prediction candidates. Ex-1022, 000001-3. This was known for H.264.

Ex-1004, ¶¶2-3. Early H.265 drafts also obtained PMV candidates from neighboring blocks, which tended to share the same motion and were thus strong candidates for the current block. Neighboring blocks were labeled based on their position relative to the current block.

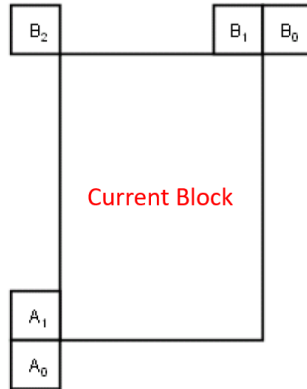

Figure 8-5 – Spatial motion vector neighbours

Ex-1010, §8.4.2.1.8. Since the encoder/decoder independently generated the same candidate list (using the same information from neighboring blocks), the encoder signaled to the decoder which candidate was chosen from the list, for example sending an index value of 2 to signal the second candidate from the list (e.g., the candidate from A1). This reduced data because the encoder did not transmit the candidate list or even an entire motion vector; instead, the encoder transmitted a single number to signal the chosen candidate, and the decoder referred to its independently-constructed candidate list, which was identical to that of the encoder, to find the candidate using the index. Ex-1004, ¶37; Ex-1003, ¶¶10-11.

A candidate list with redundant candidates increased the list index size, requiring more bits to signal. Thus, removing duplicates was known in the art, and it was common to do so by comparing a subset of candidates, rather than every possible pair of candidates, to reduce computation. For example, for H.264, it was known to “avoid duplicate[s]” by comparing new candidates to those already in the

candidate list, which comprised a “subset” of candidates from blocks within an allowed distance, rather than to the full set of previously-coded blocks. Ex-1004, ¶¶70-71. For H.265, Nakamura’s July 2011 contribution proposed “[r]emov[ing] candidates with the same motion information” (Ex-1007, Fig. 1) and comparing a subset of two candidates (i.e., “pairs”) without having to compare the full set of neighboring candidates. Ex-1007, 000003, Table 1, Fig. 1; Ex-1003, ¶¶12-14.

B. H.264 to H.265

H.264 was published in 2003 and was widely adopted. In 2004, work began on improvements to H.264, and in 2010, the formal standardization process began for the successor standard H.265 (“HEVC”). H.265 started with H.264; both shared the same architecture, with block-based motion prediction as explained. Ex-1003, ¶¶15-16.

H.265 included merge mode which was optimized for areas of uniform motion. Merge mode increased coding efficiency by eliminating the need to signal a difference motion vector, and uses the motion information from a previous block. The motion vector candidates were stored in a “merge list.” Ex-1003, ¶¶118-19.

H.265 also introduced terminology for a type of block called a coding unit (“CU”), analogous to H.264 macroblocks and divisible into smaller CUs and prediction units (“PU”) to fit visual patterns in the frame. Ex-1019, 000005; Ex-1020, 000002 (showing blocks subdivided into smaller CUs and PUs):

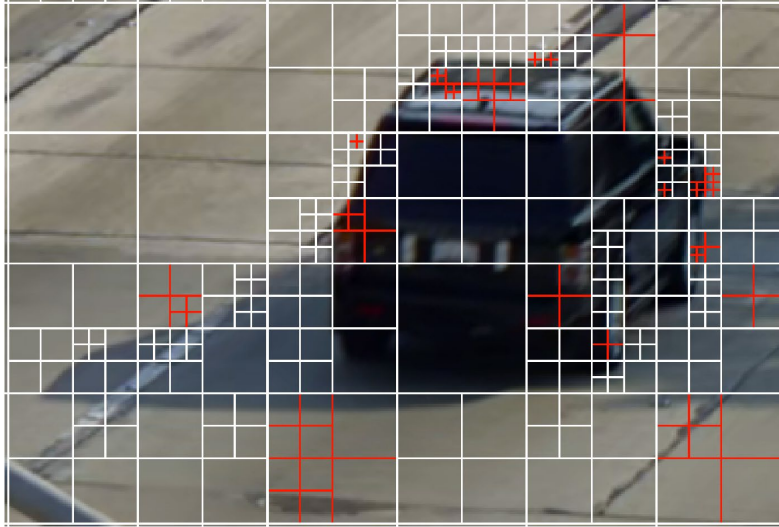

Ex-1003, ¶17.

Motion vectors operated on PUs. In its simplest case, a CU was commensurate with a PU when the entire block had uniform motion, such as large blocks of road in the above image. H.265 submissions included partition modes for dividing a CU into PUs when portions of the block had different motion.

Ex-1018, ¶3, Fig. 2 (showing various partition modes):

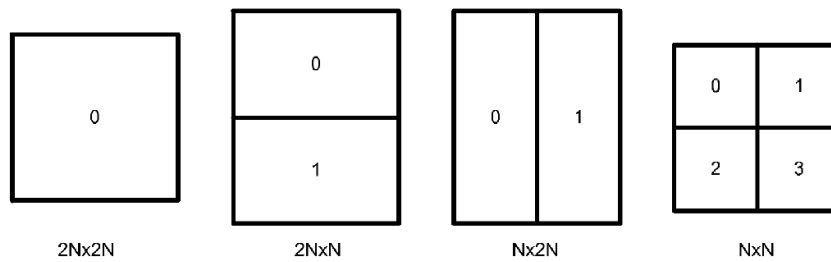

Ex-1003, ¶¶18-19.

II. '833 PATENT

The '833 patent purports to improve on H.264 and early H.265 drafts, which it admits pre-dated the patent. Ex-1001, 1:29-41, 2:10-16. The patent reduces the number of candidates in the merge list “by performing a limited number of motion information comparisons between candidate pairs to remove redundant candidates rather than comparing every available candidate pair.” Ex-1001, 4:12-15. In particular, the patent determines a “subset” of spatial candidates and compares a selected candidate with the subset, rather than the full set of candidates. Ex-1003, ¶¶20-24.

However the prior art already removed redundant candidates without comparing each pair from the full set of candidates. Ex-1003, ¶25.

A. Prosecution History

While prosecuting the '833 patent in the U.S., the applicant also filed an European counterpart EP2774375. Ex-1002, 000007; Ex-1017, 000179. An extended European search report issued March 2016, leading to a rejection based on Nakamura. Ex-1017, 000246-256. Patent Owner (“PO”) did not dispute that Nakamura was prior art, or that Nakamura taught the claims, and instead amended the claims with lengthy limitations making claim 1 over *two pages* in the EU counterpart. Ex-1017, 000335-351; Ex-1003, ¶¶26-29, ¶33.

Subsequently, PO submitted an IDS to the USPTO citing the European search report and Nakamura during prosecution of the '833 patent. Ex-1002, 000896. The Examiner did not consider this IDS before the Notice of Allowance. Ex-1002, 001155-56 (mailed 12/20/2016); Ex-1002, 001163. The '833 patent was allowed without any substantive discussion of Nakamura or amendments like those made in the EP counterpart. Ex-1002, 001033; Ex-1003, ¶27.

The Examiner issued rejections based on three academic papers to Han, Tai, and Huang. Applicant subsequently amended the claims to include the reduced-comparisons limitation, which the Examiner cited in the reasons for allowance. Ex-1002, 000998, 001002, 001005-10, 001045; Ex-1003, ¶¶30-32.

B. Priority Date

This Petition demonstrates invalidity on November 4, 2011, the earliest priority cited on the '833 patent.² Ex-1003, ¶35.

III. IDENTIFICATION OF CHALLENGE

A. Statutory Grounds

Petitioner requests *inter partes* review and cancelation of the challenged claims on the following grounds:

² Petitioner reserves the right to challenge the '833 patent's priority in other proceedings.

Grounds	Claims	Statutory Basis	Prior Art
1	1-8, 15, 17, 19-25	§103	Rusert and Zheng
2	1-8, 15, 17, 19-25	§103	Nakamura and WD4

Ex-1003, ¶36, ¶¶48-51.

The Grounds render the challenged claims obvious because any differences between the claimed subject matter and the prior art are such that the subject matter, as a whole, would have been obvious at the time the invention was made to a person of ordinary skill in the art (“POSITA”) to which the subject matter pertains. *KSR Int’l Co. v. Teleflex Inc.*, 550 U.S. 398, 406 (2007).

B. Relied-Upon Prior Art³

1. Rusert (Ex-1004)

U.S. Patent Application Publication 2011/0194609 was filed February 7, 2011, published August 2011, and is prior art under §§102(a) and (e). Ex-1003, ¶¶53-54.

³ Pre-AIA 35 U.S.C. §102 applies. MPEP §2159.02.

Rusert teaches a method for selecting a list of PMV candidates called PMV_CANDS⁴ and removes duplicates by comparing new candidates to a “subset of the set of previously coded motion vectors[.]” *E.g.*, Ex-1004, ¶¶11-13; Ex-1003, ¶¶55-56.

Rusert is analogous art in the same field (video encoding and decoding, *infra* §IV). Rusert teaches “video encoding” and “decoding.” Ex-1004, ¶1, ¶¶23-25; Ex-1003, ¶¶57-58.

2. Zheng (Ex-1005)

U.S. Patent Application Publication 2013/0077691 was filed June 18, 2012, claiming priority to six provisionals filed between June 20, 2011 and November 22, 2011. It is prior art under §102(e). Zheng is entitled to a priority date of October 4, 2011 because the relied-upon subject matter is described in Zheng’s first three provisionals, from October 4, 2011 and earlier, none of the subject matter in the last three provisionals is relied upon for any reason, and claim 1 is

⁴ Rusert occasionally misspells this as “PMV_SANDS.” This is a clear typo. “PMV_SANDS” and “PMV_CANDS” refer to the same list. *E.g.*, Ex-1004, ¶39, ¶¶42-44. Where Rusert refers to “PMV_SANDS,” the provisional correctly states “PMV_CANDS.” Ex-1004, ¶6; Ex-1012, 000009-10; Ex-1003, ¶56.

supported by the first three provisionals' written description, which enables a POSITA to make/use Zheng's claimed invention. *Dynamic Drinkware, LLC v. Nat'l Graphics, Inc.*, 800 F.3d 1375, 1381 (Fed. Cir. 2015).

Zheng's Claim 1	Zheng's Provisional Support
1. A method of coding video data comprising:	Ex-1055, Figs. 1, 3A-3B, 4-5, ¶¶6, ¶17, claim 1
determining a merge candidate set for a current prediction unit of a current coding unit, wherein the merge candidate set is determined without comparing motion information of a merge candidate in the merge candidate set to motion information of any other prediction units; and	Ex-1055, ¶¶6, ¶¶32-43, claim 1
performing a merge motion vector prediction process for the current prediction unit using the merge candidate set.	Ex-1055, ¶¶25-27, ¶29, ¶¶41-44, ¶¶63-64

Ex-1003, ¶¶59-62. Ground 1 cross-cites both Zheng and Zheng's provisionals.

Zheng teaches H.265 terminology and concepts, including merge candidate lists and removal of redundant candidates in divided CUs. Ex-1003, ¶¶63-64.

Zheng is analogous art in the same field (*infra* §IV) because it teaches H.265 video coding. Ex-1003, ¶65.

3. Nakamura (Ex-1007 through Ex-1009) and WD4 (Ex-1010)

Nakamura is a proposal for the H.265 standard presented at the 6th JCT-VC meeting, held July 14-22, 2011. Nakamura comprises a zip file uploaded to the

JCT-VC website including a main document (Ex-1007), Working Draft (Ex-1008), and presentation (Ex-1009). WD4 is a working draft of the H.265 standard that was the output of the 6th meeting. Ex-1010, 000001; Ex-1003, ¶¶288-89.

Nakamura and WD4 are prior art under §102(a). Nakamura was publicly available by July 22, 2011. Ex-1007, 000001; Ex-1014, ¶15, ¶36; Ex-1050, ¶56. At that meeting, attendees drafted Working Draft 4. WD4 was version 3 of Working Draft 4 and was made publicly available through the JCT-VC website by September 8, 2011. Ex-1014, ¶15, ¶37; Ex-1050, ¶56. Nakamura and WD4 were publicly available to all meeting participants and publicly accessible on the JCT-VC website to the general public without restriction before the '833 provisional (November 4, 2011). *See generally* Ex-1014; Ex-1050; Ex-1003, ¶290.

JCT-VC was a prominent standards-setting organization in the field of video-coding. Ex-1014, ¶22; Ex-1050, ¶¶38-40. JCT-VC meetings were high-profile, widely known to those interested in video-coding. Ex-1014, ¶22; Ex-1050, ¶¶38-40; Ex-1024; Ex-1051; Ex-1025. Meeting documents (e.g. Nakamura) were uploaded to the JCT-VC website around the time of each meeting; output working drafts, such as WD4, were uploaded shortly after. Ex-1014, ¶¶22-24; Ex-1050, ¶¶44-50. Anyone could access the JCT-VC website to download WD4 and Nakamura by visiting the Torino meeting page, which listed both documents with author and descriptive titles, or by using the search feature

for the meeting page; either approach would have easily located Nakamura and WD4. Ex-1014, ¶¶22-37; Ex-1050, ¶¶45-57. Browser search functions would also have located both. *Id.* Interested members of the public, including Dr. Reader, downloaded Nakamura and WD4 around July and September 2011. Ex-1050, ¶49; Ex-1003, ¶291. The Federal Circuit has held JCT-VC documents to be publicly accessible by the date they were available on the JCT-VC website. *M&K Holdings v. Samsung Elecs. Co.*, 985 F.3d 1376, 1380-83 (Fed. Cir. 2021).

The '833 patent admits Nakamura and WD4 were prior art, citing WD4 in its background (Ex-1001, 2:10-12) and Nakamura in the file history (*supra* §II.A). During prosecution of the EP counterpart, PO did not dispute that Nakamura was prior art. *Id.*; Ex-1003, ¶¶292-93.

Nakamura and WD4 are analogous art in the same field. *Infra* §IV. Nakamura teaches improvements for H.265 video encoding/decoding. Ex-1007, Abstract, §1, Tables 7-12; Ex-1003, ¶294. WD4 is an H.265 draft that teaches encoding/decoding video streams. Ex-1010, §7.1, §8.4. Ex-1003, ¶295.

C. Standing

Petitioner certifies that Petitioner is not barred or estopped from requesting this *inter partes* review, and the '833 patent is eligible for it.

IV. LEVEL OF ORDINARY SKILL IN THE ART

The field of the '833 patent is video encoding/decoding. Ex-1001, 1:6-8, 1:29-32, 2:10-16. A POSITA at the time of the alleged invention of the '833 patent would have had (1) a bachelor's degree in electrical engineering, computer engineering, computer science, or a comparable field of study such as physics, and (2) approximately two to three years of practical experience with video encoding/decoding. Additional experience can substitute for the level of education, and vice-versa. Ex-1003, ¶¶37-39.

V. CLAIM CONSTRUCTION

Claims should be construed according to the ordinary and customary meaning as understood by a POSITA. 37 C.F.R. §42.100(b); Ex-1003, ¶¶40-41.

A. “spatial motion vector prediction candidate”

A POSITA would have understood a “spatial motion vector prediction candidate” to mean a “candidate motion vector obtained from one or more previously-encoded blocks in the current frame.” Ex-1003, ¶42.

The '833 patent states “a spatial motion vector *prediction* is a prediction obtained only on the basis of information of one or more blocks of the same frame than the current frame.” Ex-1001, 2:65-3:3. A “*candidate* motion vector” uses “one or more neighbour blocks and/or other blocks of the current block *in the same frame*” and “represents the motion vector of one or more already encoded block.” Ex-1001, 12:38-43; Ex-1003, ¶43.

B. “temporal motion prediction candidate”

A POSITA would have understood a “temporal motion prediction candidate” to mean a candidate motion vector obtained from a previously-encoded frame.” Ex-1003, ¶44.

The ’833 patent states a “temporal motion vector *prediction* is a prediction obtained on the basis of information of one or more blocks of a frame different from the current frame.” Ex-1001, 2:65-3:3; Ex-1003, ¶45.

C. “the block”

Limitation [1d] recites “the block,” which could be interpreted to refer to either (a) the “block of pixels” introduced in [1a], or (b) the block from which the first spatial motion vector candidate is obtained. A POSITA would have understood that “the block” refers back to the “block of pixels” introduced in [1a] because there is no other block mentioned in the claim. Ex-1003, ¶46. During prosecution the Examiner applied the first interpretation, with “the” block as the “current block” (Ex-1002, 000198), which the Applicant did not dispute (Ex-1002, 000785-788). For purposes of this IPR, Petitioner applies the Examiner’s interpretation, where “the block” finds antecedent basis in the “block of pixels” in [1a]. Ex-1003, ¶46.

D. “a subset of ... candidates”

Limitations [1d], [15d], and [17d] recite “a subset of... candidates,” which means a subset of one or more candidates. The claims confirm that the subset may

comprise one candidate. Limitations [1e], [15e], and [17e] compare motion information of a potential candidate with motion information of “candidate in the determined subset” of limitation [1d], [15d], and [17d]; dependent claims 3 and 20 further specify that the potential candidate is compared with “at most one other” candidate. The specification includes embodiments where the subset is a single candidate. Ex-1001, 15:38-16:28 (e.g., block A1 is compared with only block B1), Figs. 8b, 10a-10b; Ex-1003, ¶47.

VI. CHALLENGED CLAIMS

A. Ground 1:

1. Motivation to Combine

Rusert teaches all limitations of the independent claims. Rusert uses H.264 terminology and teaches the blocks that serve as PUs in H.264 and a list of candidate vectors. To the extent the claims require H.265 PUs and a merge list, those were already in H.265 drafts and taught by Zheng. A POSITA would have been motivated to apply Rusert’s teachings to H.265 PUs, merge lists, and related concepts. Ex-1003, ¶72, ¶117.

Rusert does not itself use H.265 terminology. Nonetheless, Rusert explains that, while its examples were “given in the context of H.264/AVC, the principles disclosed herein can also be applied to... other coding standard[s], and indeed any coding system which uses predicted motion vectors.” Ex-1004, ¶116; Ex-1003, ¶73. Zheng teaches the concept of PUs in H.265, which was emerging as the

successor standard to H.264—both were drafted by the ITU-T—sharing the same concept of block-based video encoding with predicted motion vectors. Ex-1005, ¶3, ¶38; Ex-1055, ¶2, ¶24. Zheng teaches H.265 concepts including PUs. A POSITA would also have been motivated to combine teachings from Rusert and Zheng, with Rusert’s PMV_CANDS used as a merge list for Zheng’s block of pixels called a PU. This would have been a simple application of Rusert’s teachings in an H.265 context. The prior art also provides motivation to combine Rusert and Zheng and to use Zheng’s merge mode. It was known in the art that neighboring blocks in a frame’s background had the same motion information. Ex-1005, ¶¶49-50; Ex-1055, ¶¶33-34; Ex-1005, ¶69; Ex-1055, ¶41; Ex-1007, Fig. 1 (“Remove candidates with the same motion information”), Table 3; Ex-1009, 000013. Using merge mode increased coding efficiency, which both Rusert and Zheng are directed towards. Ex-1003, ¶81, ¶119, ¶102. Therefore, the prior art provides express motivation to apply Rusert’s teachings to other standards, including H.265, as taught by Zheng. Ex-1003, ¶¶74-76, ¶123.

This would have combined prior art elements according to known methods to yield predictable results, e.g., combining Rusert’s teachings for generating/deduplicating MVP candidate lists with H.265 concepts, including PUs and related information for motion vectors. In Rusert’s H.264 examples, motion vectors and motion prediction operate on blocks. Ex-1004, ¶¶2-5, ¶36, ¶43. Zheng explains

that its coding unit is akin to the macroblock of the H.264 standard. Ex-1005, ¶28; Ex-1055, ¶19; Ex-1003, ¶80. As Zheng explains, for H.265 drafts, motion vectors and motion prediction operated on blocks called PUs. Ex-1005, ¶29, ¶32, ¶36; Ex-1055, ¶20, ¶22, ¶24. Zheng teaches types of information conveyed by motion vectors. Ex-1005, ¶40, ¶49; Ex-1055, ¶25, ¶33. A POSITA would have been motivated to apply Ruser's known techniques for selecting PMV candidates for PUs, to improve the draft H.265 standard in the same way that Ruser explained for H.264. This would have been a simple substitution of Zheng's PU teachings for Ruser's block teachings, which would have yielded several advantages, including improved coding efficiency as taught by both references. Ex-1004, ¶7; Ex-1005, ¶29, ¶¶39-40; Ex-1055, ¶20, ¶25; Ex-1003, ¶¶77-81. Additionally, a POSITA would have found motivation in the similarity of the references. Both are directed to ITU video-coding standards that used block-based coding. Ex-1004, ¶116; Ex-1005, ¶3, ¶¶27-28; Ex-1055, ¶2, ¶19.

A POSITA would have been motivated to apply Zheng's merge mode in Ruser because it improved encoding efficiency for large areas of uniform motion, e.g., a static background. Merge mode improved coding efficiency by eliminating the need to signal a difference motion vector. Ex-1005, ¶41; Ex-1055, ¶¶26-27; *see also* Ex-1006, ¶7; Ex-1003, ¶118. H.265's merge mode was optimized for large areas of uniform motion. Zheng also teaches the advantages of using merge

mode including its improved coding efficiency. Ex-1005, ¶39; Ex-1055, ¶25; Ex-1003, ¶122. The spatial candidates in Rusert and Zheng are sourced from the same blocks:

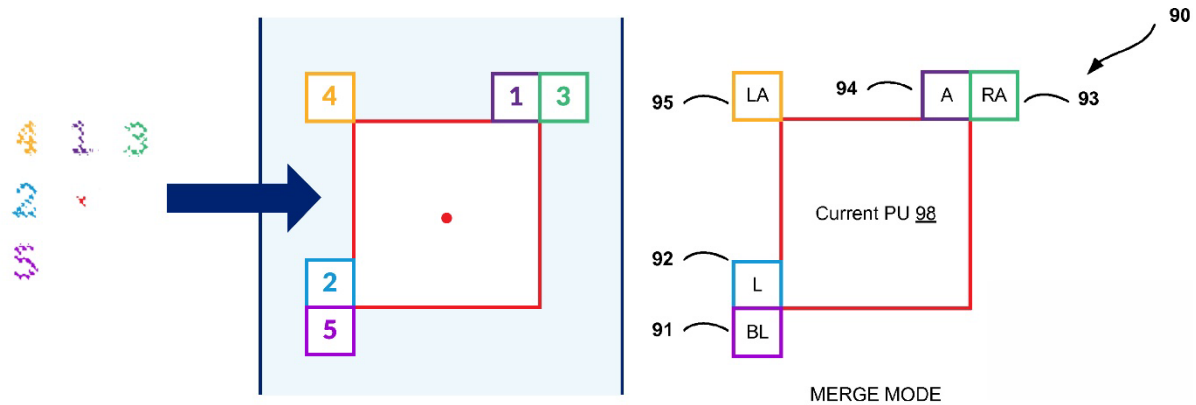

Rusert, Fig. 3n
Scan Order

Rusert Fig. 3n
Reformatted

Zheng, Fig. 1

Ex-1003, ¶¶119-20. A POSITA would have found it obvious to apply Zheng's merge list teachings to Rusert, given the similarities between the references and the scan patterns used. Ex-1003, ¶121.

A POSITA would have been motivated to combine teachings from Rusert's embodiments and background section regarding H.264 with each other. Rusert explains that its embodiments were provided in the context of H.264. Ex-1004, ¶¶3-4, ¶67, ¶77, ¶116; Ex-1003, ¶57.

Ground 1 relies on Rusert's teachings regarding PMV_CANDS, for which Rusert teaches two options: initializing and updating PMV_CANDS dynamically

for each block, or using a sliding window. Ex-1004, ¶41. A POSITA would have been motivated to use the first option (for each block) because Rusert presents it as the first of a finite number of options (two). Ex-1003, ¶111.

Zheng discusses and applies its teachings to H.264 and H.265. Therefore, Zheng's teachings regarding additional H.265 features would not have dissuaded a POSITA from combining Zheng with Rusert. Ex-1005, ¶¶28-29; Ex-1055, ¶¶19-22. H.265 does not prevent H.264 teachings from being applied, or vice-versa. Ex-1003, ¶79.

The combination would have had predictable results. Rusert already applies its teachings to block-based encoding/decoding. Ex-1004, ¶2, ¶11. A PU is a type of block. Ex-1005, ¶29, ¶32, ¶36; Ex-1055, ¶20, ¶22, ¶24; *see also* Ex-1011, ¶35. Rusert's concepts were readily applicable to PUs, and the combination would have had the predictable result of selecting candidates (as Rusert teaches) for PUs (as Zheng teaches). Ex-1004, ¶116; Ex-1003, ¶¶82-83. Rusert's teachings are applied to block-based video encoders/decoder using motion vectors, while Zheng's teachings are applied to blocks known as PUs and are also assigned motion vectors. Ex-1003, ¶124. Therefore, the combination would not have changed the principle of operation for either because it applies their teachings in the manner taught by each. Applying H.265 teachings to Rusert, and vice-versa, was

consistent with Rusert's statement that its principles are applicable to other standards. Ex-1004, ¶116; Ex-1003, ¶84, ¶¶124-26.

A POSITA would have had a reasonable expectation of success when combining Rusert and Zheng. As explained, the combination applies teachings according to their known purposes, in a conventional manner. The teachings are complementary aspects of block-based video encoding from H.264 and H.265. Ex-1004, ¶116. Zheng complements Rusert by teaching terminology and concepts from H.265. Ex-1005, ¶29, ¶32, ¶36; Ex-1055, ¶20, ¶22, ¶24; *see also* Ex-1011, ¶¶32-35. Ground 1 does not modify Rusert or Zheng in a way that would render either inoperative. To the contrary, the similarities would have given a POSITA a reasonable expectation of success in combining their teachings. Ex-1004, ¶11; Ex-1005, ¶¶4-5; Ex-1055, ¶¶3-4; Ex-1003, ¶¶85-86. As explained, the combination applies teachings according to their known purposes, in a conventional manner. Zheng's teachings of merge mode are complementary to Rusert. Ex-1005, ¶¶28-29, ¶¶40-41; Ex-1055, ¶2, ¶¶20-21, ¶¶25-26; Ex-1003, ¶125.

A POSITA would have been more than capable of applying Zheng's teachings to Rusert and vice-versa because it would simply apply Rusert's teachings from H.264 to H.265. Motion estimation had been commonplace since the 1990s; H.264 introduced MVP by the early-mid 2000s. H.265 started with

H.264, making the application of the teachings straightforward. *Supra* §I.B. These were basic aspects of video-coding a POSITA would have been knowledgeable about. *Supra* §IV; Ex-1003, ¶¶87-88.

2. Claim 1

[1pre] A method comprising:

Ground 1 teaches [1pre], e.g. “a method... of selecting a spatial motion vector prediction candidates” comprising elements explained below. Ex-1004, Abstract, ¶1, ¶11; *infra* §§VI.A.2[1a]-[1g]; Ex-1003, ¶¶66-67.

[1a]

Ground 1 teaches [1a]. Ex-1003, ¶¶68-89.

Receiving a block of pixels including a prediction unit. Rusert teaches an encoder that “applies an encoding process to the video signal” which includes blocks of pixels. Ex-1004, ¶2, ¶34, ¶36, Fig. 1:

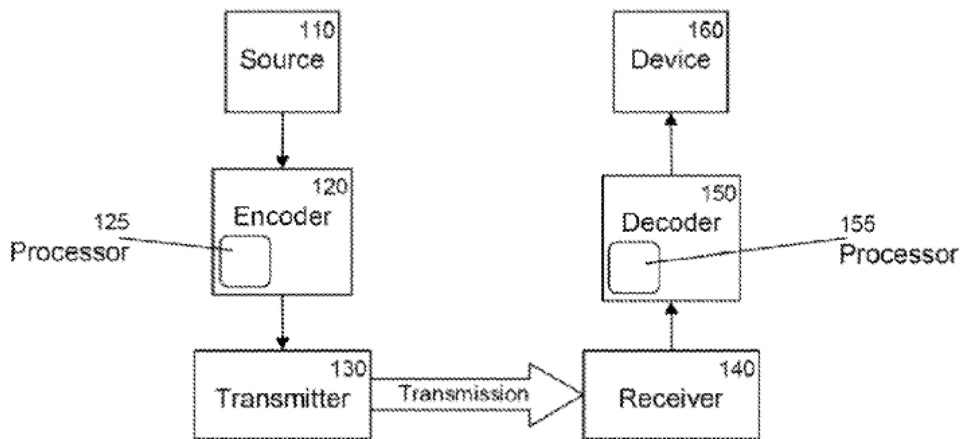

Fig. 1

Rusert encodes the video and transmits it to a receiver which passes the video stream to a decoder. Ex-1004, ¶34; Ex-1003, ¶69.

Rusert's encoder selects motion vectors for blocks of pixels. Ex-1004, ¶¶2-5, ¶36, ¶43. In Rusert's nomenclature, the block of pixels for which a motion vector is to be selected is the PU, because the block is the unit to which motion vectors are assigned for motion prediction. Ex-1004, ¶¶2-4, ¶36, ¶43; Ex-1003, ¶70.

Ground 1 combines Rusert's teaching regarding blocks to Zheng's teaching of PUs (H.265 nomenclature). Rusert's encoder operates in the context of H.264. Ex-1004, ¶¶2-5, ¶36, ¶43. Zheng's encoding process for motion vectors is in the context of H.265, and explains that a PU is a type of block for which motion vectors are assigned. Ex-1005, ¶3, ¶¶27-29, ¶38; Ex-1055, ¶2, ¶¶19-22, ¶24. It would have been obvious to apply Rusert's motion vector encoding process to Zheng's PUs in the H.265 context, and thus the combination teaches receiving a block of pixels including a PU. *See e.g.*, Ex-1005, ¶107, Ex-1055, ¶63; Ex-1003, ¶¶70-71.

[1b]

Ground 1 teaches [1b]. Ex-1003, ¶¶90-98.

Determining a set of spatial motion vector prediction candidates (e.g., the set of previously-coded motion vectors) **for the block of pixels**. Rusert's set of

spatial motion vector prediction candidates is the “set of previously coded motion vectors that were used for previous blocks having an allowed distance [and position] from the current block.” Ex-1004, ¶11, ¶15, ¶¶24-25. For a given block N that is currently being encoded, the set of spatial motion vector prediction candidates encompasses all previously encoded blocks from 1 up to N-1. Ex-1003, ¶91. As Ruserc encodes or decodes the frame, each block will have its own set of previously-coded motion vectors, that is specific to the current block, with later blocks having a commensurate larger set. *Supra* §V.A; Ex-1004, ¶59; Ex-1003, ¶¶92-93.

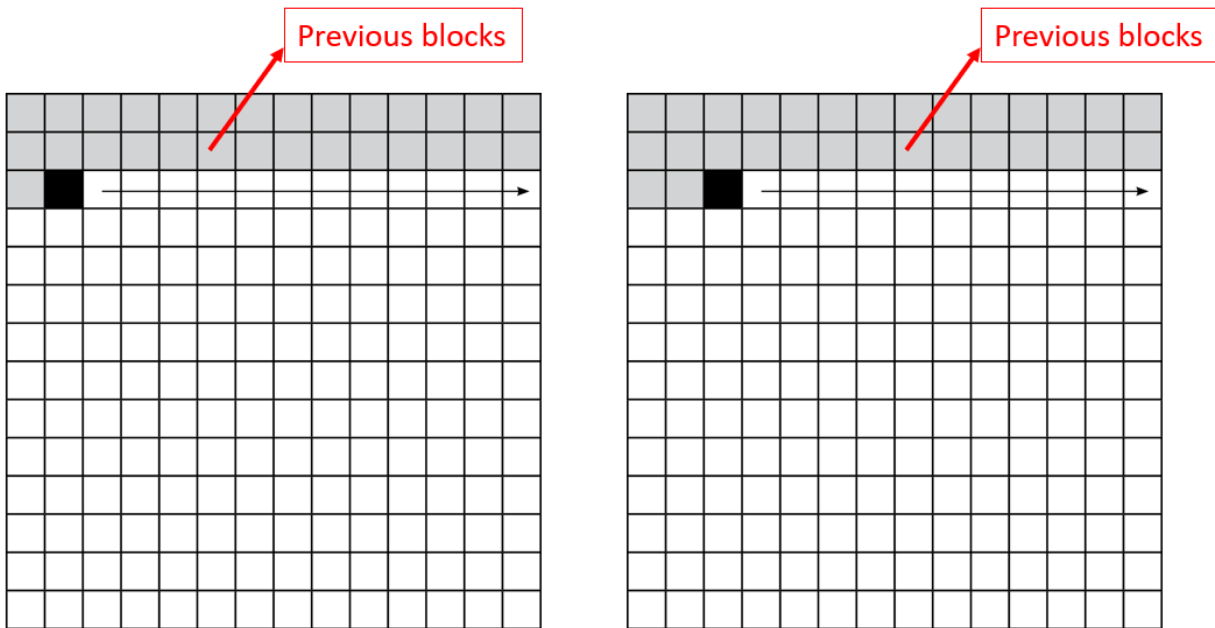

The spatial motion vector prediction candidates being provided with motion information. PMV_CANDS is a “list of PMV candidates.” Ex-1004, ¶37. Each candidate is a motion vector (Ex-1004, ¶11, ¶¶24-25, ¶¶39-41)

including “x and y components.” Ex-1004, ¶¶36, ¶¶91-94, ¶100, ¶106. Thus, Rusert’s spatial motion vector prediction candidates stored in PMV_CANDS include motion information, including the associated motion vectors (x- and y-components) of the PMV candidates. Ex-1004, ¶¶2-3; Ex-1003, ¶94.

Zheng teaches that candidates in its merge list include motion information, e.g., “encoder instructs a decoder... to copy a motion vector” (Ex-1005, ¶41; Ex-1055, ¶¶26-27), and thus Ground 1 teaches that candidates include motion information and candidates stored in Rusert’s PMV_CANDS is a merge list. Ex-1003, ¶¶95-97.

[1c]

Ground 1 teaches [1c]. Ex-1003, ¶¶99-128.

Selecting a first spatial motion vector prediction candidate from the set of spatial motion vector prediction candidates as a potential spatial motion vector prediction candidate to be included in a merge list for the prediction unit. Rusert teaches “selecting... PMV candidates” for a current block from the “set of previously coded motion vectors that were used for previous blocks.” Ex-1004, ¶¶11-12, ¶15, ¶¶24-25, ¶39, ¶44, ¶¶51-66, ¶113, Fig. 6. As Rusert encodes the blocks of a frame, each block has its own set of previously-coded motion vectors from which to select a candidate for the current block. *Supra* §V.A, §VI.A.2[1b]; Ex-1003, ¶100. Rusert teaches that the candidates are selected

Rusert's PMV_CANDS list is dynamically constructed for the current block being encoded. Ex-1004, ¶4, ¶39, ¶¶41-42; Ex-1003, ¶121. In view of Zheng, Rusert's PMV_CANDS is **a merge list for the prediction unit**, because Rusert operates on blocks of pixels, which is the unit for which motion vectors are assigned. Ex-1003, ¶¶105-06. Specifically, Zheng teaches that “[m]erge candidates are generated per PU. That is each PU has its own set of merge candidates.” Ex-1005, ¶47; Ex-1055, ¶29. Zheng teaches that “merge mode” is signaled by setting a flag and sends an index into its merge list to identify the candidate motion vector. Ex-1005, ¶¶40-41; Ex-1055, ¶¶25-27; Ex-1003, ¶105.

Where the merge list is constructed based on the motion information of the spatial motion vector prediction candidates. Zheng teaches a merge candidate list that comprises merge candidates. The merge candidates include motion information that is used for reconstructing the block at the decoder. Ex-1005, ¶38, ¶41; Ex-1055, ¶24, ¶27. When a candidate is selected, the candidate's motion information including the motion vector, reference frame, and prediction direction are used for decoding. Ex-1005, ¶109; Ex-1054, ¶2. Zheng teaches the merge list is constructed based on comparisons of the motion information of the selected candidate and the candidates currently in the merge list. Ex-1005, ¶51-56; Ex-1055, ¶35. Thus Zheng's merge list is constructed based on the candidate's motion information. Ex-1003, ¶107.

Rusert teaches that the candidates in its PMV_CANDS include motion information. PMV_CANDS is a “list of PMV candidates” for predicting the motion of the current block. Ex-1004, ¶37. These motion vectors include “x and y components.” Ex-1004, ¶106, ¶36, ¶¶91-94, ¶100. Rusert’s PMV_CANDS is updated based on comparisons involving the candidate’s motion information. Ex-1004, ¶¶71-72; *infra* §VI.A.2[1e]; Ex-1003, ¶¶108-09.

Motion information... is utilized to identify motion vector prediction candidates of which one spatial motion vector prediction candidate from the merge list is signaled as the motion information for the prediction unit. Rusert teaches sending “a code ‘index’” that identifies (i.e., signals) “a particular PMV candidate ... from a list of PMV candidates, PMV_CANDS[.]” Ex-1004, ¶¶36-37,

Fig. 1:

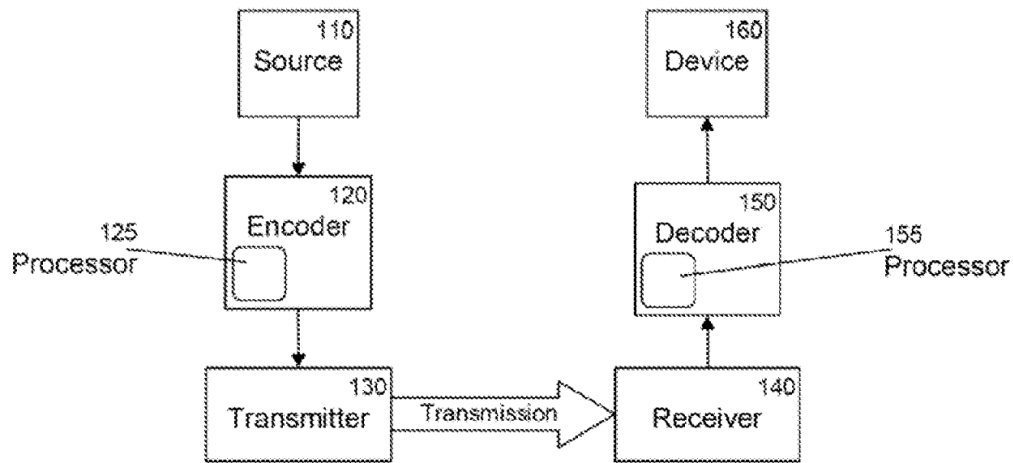

Fig. 1

Ex-1003, ¶109.

The transmitted index is used by Rusert's decoder to select the correct candidate's motion information that should be used to reconstruct the motion vector for the current block. Ex-1003, ¶110. Rusert teaches constructing the same candidate list at both the encoder and decoder, using the same construction and indexing scheme. Ex-1004, ¶35, ¶37, ¶39, ¶¶88-95. When combined with Zheng's teachings, the index is an index into a merge list, identifying a specific candidate based on its position in the list. Ex-1003, ¶110. The combination of Rusert and Zheng teaches dynamically generating the PMV_CANDS list. When the PMV_CANDS list is completed, it is a merge list. Ex-1003, ¶111. A POSITA would have understood that Zheng's merge candidate set and a merge list refer to the same concept in the encoding process of generating motion prediction candidates, and that this teaching is applicable to Rusert's construction of the PMV_CANDS list. Ex-1003, ¶112. Zheng also teaches using the candidates' motion information in the merge list, based on identifying the best candidate in the merge list for use in motion prediction for the current block. Ex-1005, ¶107, ¶109; Ex-1055, ¶63-64; Ex-1003, ¶¶112-15. Finally, both Rusert's and Zheng's teachings are applicable to both video encoders and decoders. Ex-1005, ¶93; Ex-1055, ¶52; Ex-1004, ¶35, ¶¶24-25; Ex-1003, ¶127.

[1d]

Determining a subset of spatial motion vector prediction candidates.

Rusert “select[s] a set of PMV candidates as a *subset* of the set of previously coded motion vectors that were used for previous blocks[.]” Ex-1004, ¶¶11-12, ¶¶24-25; *supra* §V.D. Rusert’s subset is based on a scan of previous PMV candidates that are within an allowed distance and relative position. “[T]he selected set of PMV candidates comprises a subset of the set of previously coded motion vectors... having an allowed distance from the current block and an allowed position[.]” Ex-1004, ¶15, ¶37, Figs. 2a-2b; Ex-1003, ¶¶130-31. The scan pattern of Figure 3n with an allowed distance of 1 results in a scan pattern consistent with Zheng’s merge list candidates:

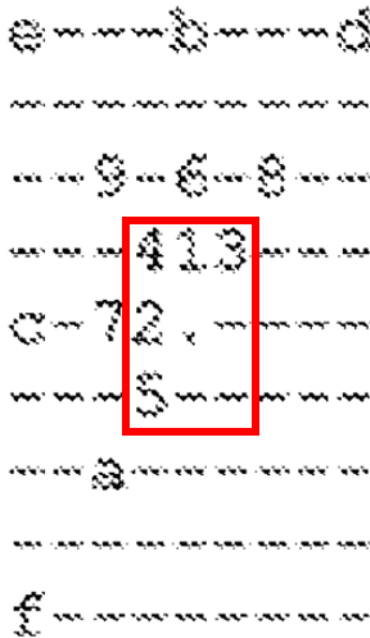

Fig. 3n

Ex-1003, ¶131.

As Ruser's scan progresses, the subset of PMV candidates comprises the previously-coded PMV candidates obtained from previous blocks in the scan pattern from the initial block (e.g., 1) up to candidate being evaluated (e.g., 3).

Ex-1004, ¶¶4-5, ¶¶36-39, ¶¶43-44, ¶¶51-66. For example, using the scan pattern of Fig. 3n, when block "3" is selected in limitation [1c], the subset of PMV candidates comprises the candidates from blocks 1 and 2 as illustrated below. *Id.* When block "4" is selected, the subset comprises the candidates from blocks 1, 2, and 3, and so on. *Id.*; Ex-1003, ¶132.

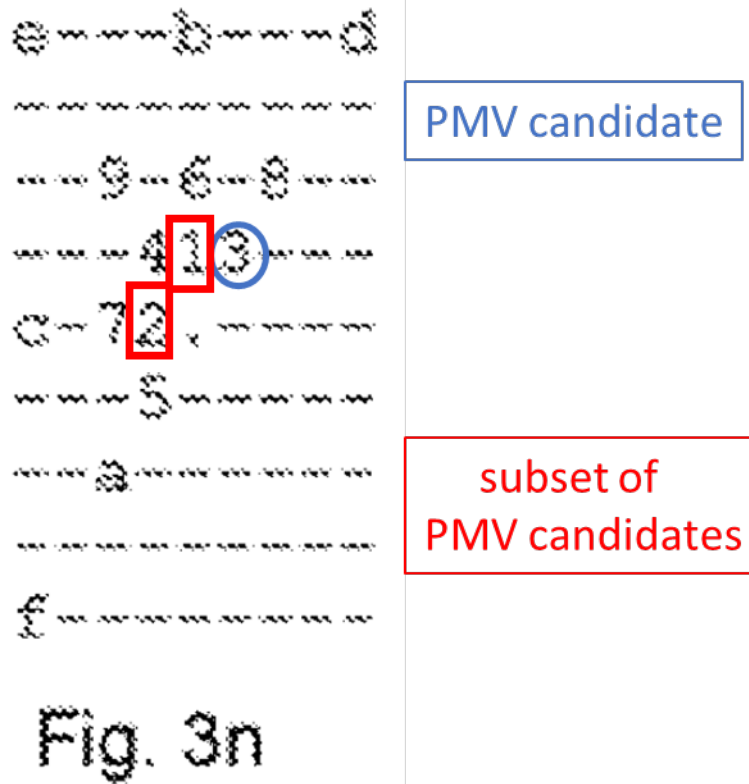

Fig. 3n

Rusert’s subset of candidates are a subset of the larger set of all previously-coded motion vectors as explained. *Supra* §VI.A.2[1b]; Ex-1003, ¶133.

Additionally, Rusert terminates the scan “as soon as a pre-defined number of unique PMV candidates have been found.” Ex-1004, ¶48. PMV candidates that are within “a certain distance” and part of “a predetermined scan pattern” are not considered if the “pre-defined number of unique PMV candidates have been found.” Ex-1004, ¶¶44-49. Therefore, Rusert’s scan of previously-coded motion vectors is further cabined into a subset because it is limited to this predefined number of PMV candidates. Rusert does not consider every candidate in every block of its scan sequence and instead determines a subset of PMV candidates,

from the scan sequence, within a pre-defined number. For example, while Fig. 3n includes a scan of up to 15 blocks, Rusert terminates the scan with a subset of candidates from those blocks when a pre-determined number of candidates are obtained (e.g., 7). Ex-1004, ¶48, ¶107; Ex-1003, ¶¶133-34.

Based on a location of the block associated with the first spatial motion vector prediction candidate. Here, “the block” refers to the “block of pixels” in [1a] and therefore refers to the current block for which candidates are being considered. *Supra* §V.C. Because, the subset of PMV candidates is based on a “scan... around the current block” (Ex-1004, ¶44), the subset of blocks that are scanned for potential inclusion in the subset of PMV candidates is based on the location of the current block within the frame, e.g., block N. Ex-1003, ¶135. Rusert teaches that the set of scanned blocks is determined relative to the location of the current block. Thus, scanned blocks 1, 2, 3, 4, and 5 refer to *different* blocks within the frame when the current block being encoded changes. In other words, the blocks in the scan order refer to different absolute block numbers when encoding for example, block 65 versus block 66 of the frame. Thus, the location of the current block is associated with all spatial motion vector prediction candidates, including the first one. Ex-1003, ¶136.

Additionally, the subset of PMV candidates is based on “an allowed distance from the current block and an allowed position.” Ex-1004, ¶15, ¶¶11-13, ¶17,

¶¶24-25, ¶113, Fig. 6. The distance and position are relative to and therefore based on the location of the current block. Ex-1004, ¶¶11-17, ¶¶24-25, ¶¶43-44, ¶¶51-66, Figs. 3a-3n. Rusert teaches exemplary distance values⁵ based on the location of the current block (“.”). Ex-1004, ¶47, ¶13, ¶43, Figs. 3d, 3f, 3g:

```

22222
21112
21.12
21112
22222

```

Fig. 3d

```

3333333
3222223
3211123
321.123
3211123
3222223
3333333

```

Fig. 3f

```

3333333
3222223
3211123
321.---
321-----
322-----
333-----

```

Fig. 3g

Only candidates from blocks with allowed positions relative to the current block are included. Ex-1004, ¶¶15-16, ¶59 (excluding “blocks to the right and below the current block”), ¶65; Ex-1003, ¶¶137-39.

Even if “the block” was interpreted as the block from which the selected first candidate is obtained, Rusert teaches this. *Supra* §V.C. The “position” of a block’s PMV candidate is represented as (xpos, ypos), i.e., a location of the block associated with the first spatial motion vector prediction candidate. Ex-1004, ¶¶51-52. Based on the block’s location, the subset of PMV candidates with which the PMV candidate is compared includes the candidates of blocks located in the

⁵ “Euclidean distance” is occasionally misspelled “Euclidian distance.”

Ex-1003, ¶137 n.3.

scan pattern up to the PMV candidate. Ex-1004, ¶44. For example, in Fig. 3n, the PMV candidate for block “3” is compared with a subset of PMV candidates for blocks “1” and “2” for de-duplication, as explained for [1c]-[1e]. Ex-1004, ¶44, ¶¶65-66, Fig. 3n:

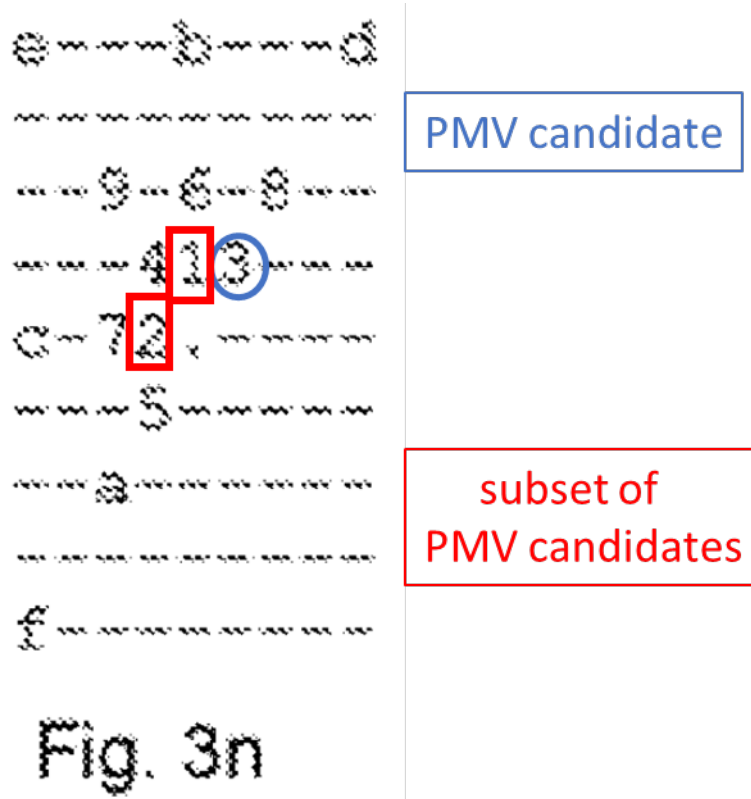

Ex-1003, ¶140. The subset is determined for each encoded block separately, and the set of scanned blocks is determined relative to the location of the current block within the frame (the dot (“.”) in Fig. 3n). When the frame’s next block is encoded, and therefore the current block changes, the scanned blocks refer to different blocks within the frame, i.e., there are different subsets for encoded blocks at different locations within the frame. For example, within the scan order,

block “3” may be the same relative position, the absolute location of block “3” is different within the frame and depends on the location of the current encoded block. Thus, the absolute x-, y- positions of blocks in the scan order within the frame changes when the current block that is being encoded changes, even if the relative position does not. Ex-1003, ¶141.

[1e]

Ground 1 teaches [1e]. Ex-1003, ¶¶143-57.

Comparing motion information of the first spatial motion vector prediction candidate with motion information of spatial motion vector prediction candidates in the determined subset of spatial motion vector prediction candidates... wherein comparing comprises performing an equivalence check or comparing a difference in motion information to a threshold or other similarity metric. Ruser teaches three comparisons that comprise an equivalence check, comparing a difference in motion information to a threshold, or other similarity metric, each of which satisfies [1e]. Ex-1004, ¶21, ¶¶71-72; *supra* §VI.A.2[1c]; Ex-1003, ¶144.

First, Ruser’s equivalence check compares whether “the PMV candidate is a duplicate of another PMV candidate” in the subset of PMV candidates, which is stored as a list in PMV_CANDS. Ex-1004, ¶21, ¶71. “This ca[n] be done, when updating the list, by comparing the candidates already in the list with the new

vector that could be added, and if a duplicate is found... [i]t is preferable to skip the new vector” thus “reducing the number of candidates[.]” Ex-1004, ¶¶71, ¶62. A potential PMV candidate is selected and compared with each PMV candidate in the subset of preceding PMV candidates in Ruser’s scan pattern, which are the candidates already stored in PMV_CANDS. *Supra* §VI.A.2[1d]. If the x- and y-components of two motion vectors are the same, they are equivalent and the potential candidate is excluded. *Id.*; Ex-1003, ¶145.

Second, Ruser compares whether “the PMV candidate is... within a threshold distance of an existing PMV candidate” in the subset of candidates stored in PMV_CANDS, e.g., using “a similarity measure” such as Euclidean distance to calculate whether the difference between the x- and y- components of their motion vectors is “smaller than a pre-defined threshold.” Ex-1004, ¶¶21, ¶72, ¶87. The distance between duplicate PMV candidates is zero. Ex-1003, ¶146, ¶146 n.4.

Third, Ruser compares whether “at least one alternative PMV candidate will allow motion vectors to be coded using fewer bits” (Ex-1004, ¶21) thereby using a “similarity metric” by “removing PMV candidates” that “will never be used” because another candidate stored in PMV_CANDS facilitates “a bit sequence that is shorter or of the same length compared for all possible motion vectors.” Ex-1004, ¶¶90-94, ¶95 (teaching exemplary PMV/DMV combinations requiring fewer bits); Ex-1003, ¶¶147-48.

All three compare a potential candidate with at least one other candidate from the subset of preceding candidates in Ruser's scan pattern. Since preceding candidates have smaller index values, they would be signaled more efficiently than later duplicates, and Ruser improves efficiency by determining this subset and comparing potential new candidates to the subset. Ex-1004, ¶¶88-98; Ex-1003, ¶149.

All three compare motion information of the PMV candidates, including the components of their motion vectors. This is motion information of the PMV candidates because they describe the "motion of pixel blocks across frames[.]" Ex-1004, ¶2; *supra* §VI.A.2[1b] (explaining motion information); Ex-1003, ¶149.

Ruser teaches or at least suggests performing one of these comparisons when evaluating whether to update PMV_CANDS with a candidate. Ex-1004, ¶71, ¶75, ¶¶84-87, ¶90. This process is used when decoding an encoded block of pixels; the same list of candidates is constructed for encoding and decoding. Ex-1004, ¶35; Ex-1003, ¶150.

Comparing... without making a comparison of each possible candidate pair from the set of spatial motion vector prediction candidates. Each of Ruser's three comparisons (explained above) compares motion information of a selected candidate with the subset of PMV candidates stored in PMV_CANDS, without making a comparison of each possible pair from the set of motion vectors

used for all previous blocks. Ex-1004, ¶¶11-13, ¶¶15-16, ¶113. Rusert teaches that the subset of PMV candidates is a “subset of the motion vectors previously used for previous blocks” meaning Rusert does not compare each possible pair from the “set of previously coded motion vectors... used for previous blocks[.]” Ex-1004, ¶¶11-12, ¶¶24-25. Even within the scan order, Rusert compares potential candidates with preceding candidates already in PMV_CANDS, which are a subset of the candidates in the scan order; therefore, Rusert avoids comparing each possible pair of candidates from the scan order. *See id.*; Ex-1003, ¶¶151-53.

Moreover, even within Rusert’s scan patterns, Rusert teaches that a “scan may be terminated... as soon as a pre-defined number of unique PMV candidates have been found[.]” Ex-1004, ¶48. For example, Rusert teaches “us[ing] a maximum of four candidates in the [PMV_CANDS] list” or “us[ing] seven” as the maximum. Ex-1004, ¶107. Therefore, Rusert does not compare each possible pair of candidates from the set of all previously-coded blocks, or even each possible pair of blocks within the scan order. Rusert thus teaches Claim 1 with the recited “determined subset” being either (a) the previously-coded motion vectors for the block as selected in limitation [1d], or (b) the full set of candidates from Rusert’s scan order, because in both cases Rusert compares the selected candidate with a subset of candidates, without comparing each pair from the set of previously-coded motion vectors or the entire scan order. Ex-1003, ¶154.

Additionally, because the subset is limited to candidates having “an allowed distance” and “position[,]” candidates from previous blocks outside the allowed distance/position are not in PMV_CANDS and, therefore, are not compared.

Ex-1004, ¶15; *supra* §VI.A.2[1d]. Furthermore, Rusert teaches scan patterns that exclude certain blocks within the allowed distance. Ex-1004, ¶¶64-65, Figs. 3m, 3n. Given these excluded blocks, there is no comparison of each pair of motion vectors from the set of all previously-coded blocks. Ex-1003, ¶¶152-53.

[1f]

Ground 1 teaches [1f]. Ex-1003, ¶¶158-64.

If at least one of the comparisons indicates that the motion vector information of the spatial motion vector prediction candidates correspond with each other, excluding the first spatial motion vector prediction candidate from the merge list. As explained, Rusert determines whether to exclude the selected first spatial motion vector prediction candidate from the merge list stored in PMV_CANDS, based on one of the comparisons explained for [1e]. Rusert removes “unnecessary PMV candidates” to “ensure[] the length of the [PMV_CANDS] list is not unnecessarily long, which would reduce coding efficiency.” Ex-1004, ¶¶20-21. Rusert explains that “[a] PMV candidate may be determined to be unnecessary” and therefore excluded based on the comparisons. Ex-1004, ¶21; *supra* §§VI.A.2[1c], [1e]. “Unnecessary PMV candidates are

removed... because it may happen that some candidates in the list will never be used.” Ex-1004, ¶90. A shorter PMV_CANDS “allows the remaining PMV candidates to be signaled using shorter codes and so fewer bits[.]” Ex-1004, ¶22, ¶90; Ex-1003, ¶¶159-60.

Rusert excludes unnecessary candidates when deciding whether to add a new candidate to the subset of PMV candidates stored in PMV_CANDS. Ex-1004, ¶21, ¶¶71-72; *supra* §VI.A.2[1e]. As part of the “update” process whereby new candidates are added, Rusert determines whether a selected PMV candidate should be included, meaning it is excluded based on any of the comparisons from [1e]. Ex-1004, ¶¶71-72. Additionally, this would have been obvious because Rusert teaches the advantages of reducing the number of candidates in PMV_CANDS using the comparisons from [1e] (Ex-1004, ¶12, ¶21, ¶70, ¶84, ¶90), and the natural time to perform the comparisons would have been when evaluating whether to add a candidate to the subset of PMV candidates stored in PMV_CANDS. As Rusert teaches, performing this check when PMV_CANDS is updated prevents “unnecessary” candidates from being added, “because it may happen that some candidates... will never be used[.]” Ex-1004, ¶90; Ex-1003, ¶161.

[1g]

Causing information identifying the one spatial motion vector

prediction candidate from the merge list to be transmitted to a decoder or to

be stored. Ruser teaches sending an index from its encoder to the decoder to

identify a specific “candidate... from a list of PMV candidates, PMV_CANDS[.]”

Ex-1004, ¶¶36-37. The transmitted index is information used by Ruser’s decoder

to select the correct candidate that should be used to reconstruct the motion vector

for the current block. *Id.* Ruser teaches an encoder that identifies a spatial motion

vector prediction candidate from the merge list to be transmitted to a decoder.

Ex-1003, ¶¶165-70. This process is illustrated in Ruser’s Figures 2a and 2b:

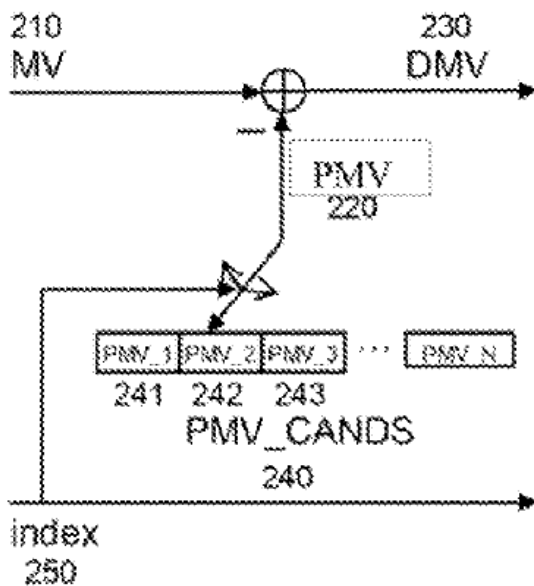

Fig. 2a

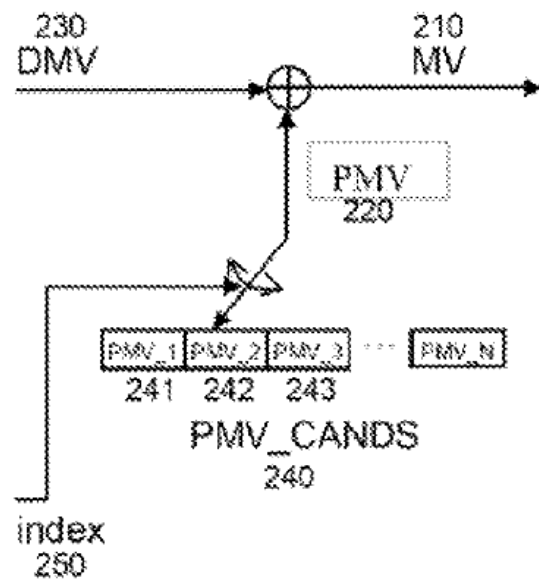

Fig. 2b

Ex-1004, Figs. 2A-B; Ex-1003, ¶168.

3. Claim 2

2. The method according to claim 1 comprising selecting spatial motion vector prediction candidates from the set of spatial motion vector prediction candidates as the potential spatial motion vector prediction candidate in a predetermined order.

Ground 1 teaches claim 2. Ex-1003, ¶¶171-75. Ruser explains that its scan pattern is in a specific order and is “predetermined.” Ex-1004, ¶49 (“all blocks of a *predetermined* scan pattern have been scanned”), ¶65. For example, Ruser’s scan pattern illustrated in Fig. 3n indicates that the blocks are visited in order from 1, 2, 3, ... to f(15):

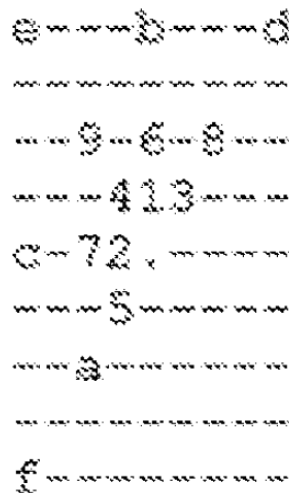

Fig. 3n

Ex-1004, Fig. 3, ¶64; Ex-1003, ¶¶173-74.

4. Claim 3

3. The method according to claim 1, comprising comparing motion information of the potential spatial motion vector prediction candidate with motion information of at most one other spatial motion

vector prediction candidate of the set of spatial motion vector prediction candidates.

Ground 1 teaches claim 3. Ex-1003, ¶¶176-81. Ruser teaches three comparisons; each satisfies the comparing step explained for [1e]. *Supra* §VI.A.2[1e]; Ex-1004, ¶21. Ruser further teaches claim 3’s additional limitation of comparing motion information for at most one other candidate of the set. For Ruser’s scan sequences (*supra* §§VI.A.2[1b]-[1d]; Ex-1004, ¶44, ¶¶51-66, Figs. 3a-3n), the “PMV_CANDS list may be initialized e.g. as an empty list (zero entries)” and then “updated to include previously coded motion vectors[.]” Ex-1004, ¶39, ¶44, ¶71; *supra* §VI.A.2[1e]. When Ruser updates PMV_CANDS with the second PMV candidate in the sequence, that candidate is “compar[ed with] the candidates already in the list[.]” which is at most the first PMV candidate in the scan sequence. Ex-1004, ¶21, ¶¶38-40, ¶44, ¶71. Therefore, the motion information of the second candidate in the sequence is compared with at most one other PMV candidate (the first PMV candidate). Ex-1003, ¶¶177-81.

5. Claim 4

4.

Ground 1 teaches claim 4. Ex-1003, ¶¶182-200.

Examining whether the received block of pixels is divided into a first prediction unit and a second prediction unit. Ruser teaches receiving a block

of pixels (the current block). Ex-1004, ¶¶34-36, Fig. 1; *supra* §VI.A.2[1a]; Ex-1003, ¶177. Zheng teaches H.265 nomenclature such as PUs. *Supra* §VI.A.2[1a]; Ex-1003, ¶184.

Zheng examines whether blocks are divided. As Zheng explains, in H.265, “a coding unit may have variable sizes depending on video content.... In particular, each coding unit may be further partitioned into prediction units (PUs) and transform units (TUs).” Ex-1005, ¶29; Ex-1055, ¶20. Zheng teaches that a CU can be partitioned, either horizontally or vertically, into PUs. Ex-1005, ¶47, Fig. 2; Ex-1055, ¶¶29-31, Figs. 2, 3A-3B. When a CU is divided, the resulting PUs are symmetric with respect to the division orientation. Ex-1005, ¶47, Figs. 2, 3A, 3B; Ex-1055, ¶¶29-31, Figs. 2, 3A-3B; Ex-1003, ¶178. Zheng teaches both types of partitioning, where the CU is divided into two PUs (PU0 and PU1). Ex-1005, ¶47, Figs. 2, 3A, 3B;⁶ Ex-1055, ¶¶29-31, Figs. 2, 3A-3B.

⁶ When the PTO published Zheng, Figs. 3A and 3B were not exact reproductions of the as-filed figures. Ex-1062, 000049 (Figs. 3A-B). Higher-quality figures from the as-issued Zheng patent (US9313494) were reproduced here for clarity. Ex-1061, Figs. 3A-B.

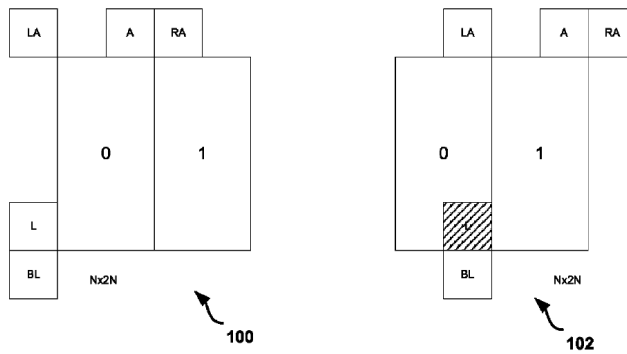

FIG. 3A

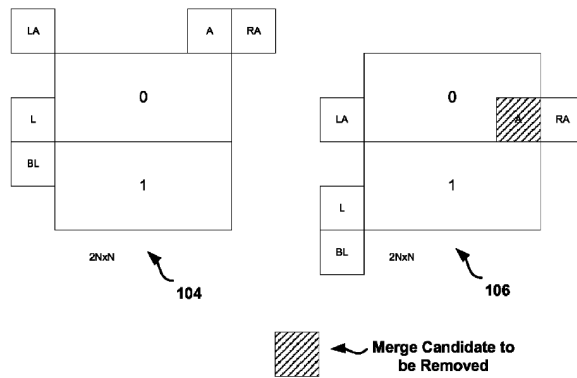

FIG. 3B

Ex-1061, Figs 3A-B.

Zheng examines whether the received encoded block is divided into PUs, either horizontally or vertically. Zheng explains that “merge candidates within the merge candidate set for a current prediction unit may be removed/excluded if they are within another prediction unit of the *same coding unit*.” Ex-1005, ¶78; Ex-1055, ¶30. Specifically, Zheng teaches “techniques to avoid using redundant merge candidates for PUs of the same CU. A redundant merge candidate is a merge candidate that has the same motion information as another PU in the same CU.” Ex-1005, ¶49; Ex-1055, ¶33; *see also* Ex-1005, ¶58; Ex-1055, ¶33, ¶36, ¶44;

Ex-1056, ¶28. Zheng teachings apply to both encoders and decoders. Ex-1003, ¶186.

And if so, excluding the potential spatial motion vector prediction candidate from the merge list if the prediction unit is the second prediction unit. Zheng examines whether (i) the current block is divided into two PUs and (ii) the spatial motion vector prediction candidate is from the other PU; if so, Zheng excludes the candidate from the merge list because it is redundant.

Ex-1005, ¶78; Ex-1055, ¶44.

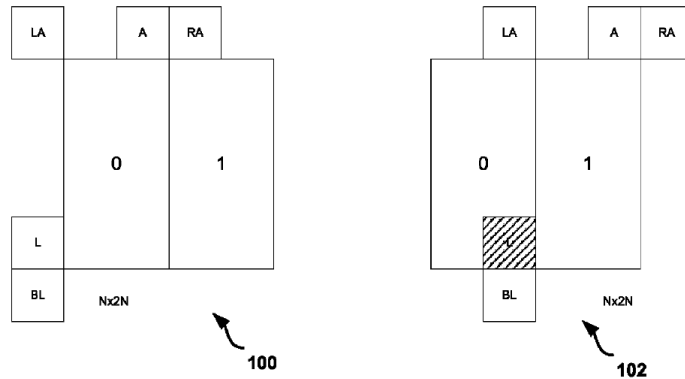

FIG. 3A

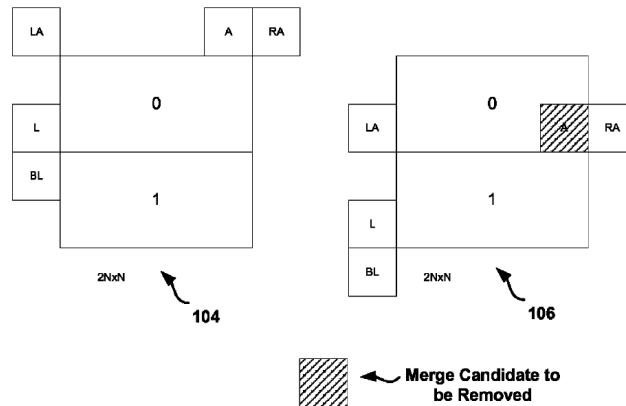

FIG. 3B

Ex-1061, Figs. 3A-3B.⁷ As explained, Zheng excludes candidates from the merge list for a current PU, if the candidate is within another PU of the same CU. Specifically, Zheng explains in the “2NxN/Nx2N cases: if a merge candidate for the second PU (PU 1) has the same motion information as that of the first PU (PU 0), that merge candidate will be set as not available.” Ex-1005, ¶58; Ex-1056, ¶28; Ex-1003, ¶¶187-88. For a block with uniform motion, there is no reason to partition it into multiple PUs; conversely if different parts of the block were moving in different directions, dividing into multiple PUs would have been advantageous as each PU would be assigned its own different motion vector. This concept would have been obvious in light of Zheng’s teachings applied to Rusert. Ex-1003, ¶¶189-99.

6. Claim 5

[5pre] The method according to claim 1, further comprising

Ground 1 teaches [5pre]. *Supra* §VI.A.2; Ex-1003, ¶201.

⁷ See *supra* n.6

[5a] determining a maximum number of spatial motion vector prediction candidates to be included in a merge list; and

Ground 1 teaches [5a]. Ex-1003, ¶¶202-08. As explained, Ground 1 selects spatial motion vector prediction candidates as potential candidates to be included in Ruser's merge list ("PMV_CANDS"). *Supra* §VI.A.2[1c]; Ex-1003, ¶202.

Ruser teaches "the number of candidates in PMV_CANDS may be limited to a pre-defined or dynamically obtained number" including one, four, or seven. Ex-1004, ¶73, ¶77, ¶¶84-90, ¶107. Ruser "reduce[s] the overhead of signaling which PMV is used for motion vector prediction, since shorter lists require shorter code words" and balances the increased chance of a suitable match with the increased cost of longer code words by choosing a limit. Ex-1004, ¶84, ¶13, ¶70, ¶107; Ex-1003, ¶¶203-04. It would have been obvious to use Ruser's PMV_CANDS as a merge list with Ruser's PMV candidates as merge candidates in view of Zheng's teachings. *Supra* §VI.A.1; Ex-1003, ¶¶206-08.

Additionally, Ruser teaches VLC index values that "depend on the maximum number of candidates in PMV_[C]ANDS" denoted as "Maximum list size C[.]" Ex-1004, ¶88. Therefore, Ruser determines a maximum number of candidates "C" which dictates index values. Ex-1003, ¶205.

[5b] limiting the number of spatial motion vector prediction candidates in the merge list [to be] smaller or equal to the maximum number.

Ground 1 teaches [5b]. Ex-1003, ¶¶209-15. Ruser teaches “an outwards going scan... to obtain motion vectors to update PMV_[C]ANDS... may be terminated... as soon as a pre-defined number of unique PMV candidates have been found[.]” Ex-1004, ¶¶44-48. Furthermore, Ruser teaches “the candidate at the end of the PMV_CANDS may be removed” to limit “the number of candidates in PMV_CANDS... to a pre-defined... number[.]” Ex-1004, ¶73. Thus, the number of PMV candidates in PMV_CANDS is smaller or equal to the pre-defined maximum number. Ex-1003, ¶¶210-11. It would have been obvious to use Ruser’s PMV_CANDS as a merge list with Ruser’s PMV candidates as merge candidates in view of Zheng’s teachings. *Supra* §VI.A.1; Ex-1003, ¶¶213-15.

Additionally, Ruser teaches VLC examples based on the “Maximum list size C” of PMV_CANDS that limit the number of candidates in PMV_CANDS to the specified maximum. Ex-1004, ¶88; Ex-1003, ¶212.

7. Claim 6

[6pre] The method according to claim 5 comprising:

Ground 1 teaches [6pre]. *Supra* §VI.A.6; Ex-1003, ¶216.

[6a] examining, if the number of spatial motion vector prediction candidates in the merge list [is] smaller than the maximum number;

Ground 1 teaches [6a]. Ex-1003, ¶¶217-22. Ruser continues scanning for new candidates while their number is smaller than a pre-determined number; Ruser “terminat[es]” the scan for new candidates “as soon as a pre-defined number of unique PMV candidates have been found[.]” Ex-1004, ¶¶44-48, ¶13, ¶¶70-77, ¶¶84-90, ¶107; *supra* §VI.A.6. Additionally, Ruser teaches that “the candidate at the end of the PMV_CANDS may be removed” to limit “the number of candidates in PMV_CANDS... to a pre-defined... number.” Ex-1004, ¶73; Ex-1003, ¶¶218-19. It would have been obvious to use Ruser’s PMV_CANDS as a merge list with Ruser’s PMV candidates as merge candidates in view of Zheng’s teachings. *Supra* §VI.A.1; Ex-1003, ¶¶220-22.

[6b] if so, examining whether the prediction unit to which the potential spatial motion vector prediction candidate belongs is available for motion prediction;

Ground 1 teaches [6b]. Ex-1003, ¶¶223-32. Ruser obtains potential spatial motion vector prediction candidates from neighboring blocks. Ex-1004, ¶44, ¶¶51-66, Figs. 3a-3n; *supra* §VI.A.2[1c]. While scanning, Ruser examines whether the block to which a potential candidate belongs, is available for motion prediction. First, Ruser teaches that blocks “coded after the present block” “would never be available[.]” Ex-1004, ¶54. Second, blocks are “sometimes...

available depending upon the traversal pattern used” to reach the current block, where some blocks would not be coded yet and would not have motion information for motion prediction. *Id.* Third, Rusert examines whether blocks have “no motion vector present” or have “the same [motion vector] as a block earlier in the sequence” and are thus not available (since Rusert seeks to avoid duplication). *Id.*; Ex-1003, ¶¶223-28.

Rusert’s block is a PU because it is the unit for which a motion vector is assigned for motion prediction. Ex-1004, ¶¶2-5, ¶36, ¶43; *supra* §VI.A.2[1a] (explaining PUs). Ground 1 applies Rusert’s motion vector teachings to PUs, as explained. *Supra* §VI.A.1, §VI.A.2[1a]; Ex-1004, ¶¶3-4, ¶36; Ex-1005, ¶3, ¶¶27-29, ¶38; Ex-1055, ¶2, ¶¶19-22, ¶24. It would have been obvious to examine whether a PU, which Zheng teaches is the block for which motion vectors are assigned, is available for motion prediction because Rusert teaches three reasons why a motion vector might not be available for a block. Ex-1005, ¶¶28-30, ¶38; Ex-1055, ¶2, ¶¶19-21, ¶24; Ex-1003, ¶¶229-32.

[6c] if so, performing at least one of the following:

...

[6k] ...

Ground 1 teaches [6k] which also satisfies [6c]. Ex-1003, ¶¶233-41.

As explained, Rusert's block is a PU, and Ground 1 applies Rusert's teachings, e.g. for scanning and analyzing motion vectors from blocks, to PUs. *Supra* §VI.A.2[1a] (explaining Rusert's blocks), §VI.A.1 (motivation to combine); Ex-1004, ¶¶2-5, ¶36, ¶43; Ex-1005, ¶¶33-36, ¶¶64-67; Ex-1055, ¶22, ¶39, ¶79, ¶84; Ex-1003, ¶¶233-34.

If Rusert's scan continues (*supra* §VI.A.7[6a]), Ground 1 teaches performing the step of [6k]. Rusert applies the below-explained teaching **for a potential spatial motion vector prediction candidate** (from block 5), **which is below the potential spatial motion vector prediction candidate on the left side** (from block 2) **of the prediction unit**. Rusert's scan pattern in Fig. 3n proceeds in numerical order. Ex-1004, ¶¶65-66. The PMV candidate for block 5 is below the candidate for block 2, which is on the left side of the current block (“.”) for which candidates are being evaluated. *Id.*, Fig. 3n:

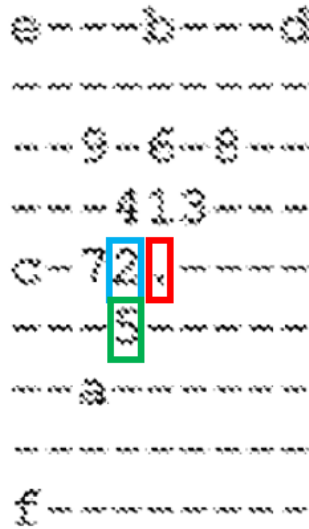

Fig. 3n

Ex-1003, ¶¶234-35. These blocks are PUs, and Ground 1 applies these teachings to PUs. Ex-1003, ¶¶240-41.

Excluding the potential spatial motion vector prediction candidate from the merge list if the potential spatial motion vector prediction candidate has essentially similar motion information than the spatial motion vector prediction candidate on the left side of the prediction unit. When analyzing a potential candidate, Ruser teaches “comparing the [PMV] candidates already in [PMV_CANDS] with the new [PMV candidate] that could be added, and if a duplicate is found,... skipping the new [PMV candidate].” Ex-1004, ¶¶71-72, ¶21. Ruser excludes the potential candidate from PMV_CANDS if “the PMV candidate is a duplicate of another PMV candidate” in PMV_CANDS or if it has essentially similar motion information, e.g., if “the PMV candidate is... within a

threshold distance of an existing PMV candidate” in PMV_CANDS. Ex-1004, ¶21, ¶62, ¶¶71-72, ¶87. In Fig. 3n, when Rusert evaluates whether to update PMV_CANDS with the candidate from block 5, Rusert compares it with candidates already in PMV_CANDS, e.g., from blocks 1, 2, 3, and 4. Ex-1004, ¶44, ¶¶65-66, ¶¶71-72, Fig. 3n. If the candidate from block 5 has essentially the same motion information compared with the candidate from block 2, then Rusert excludes the potential candidate from block 5. *Id.*

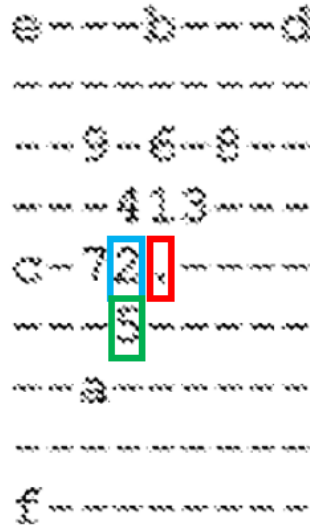

Fig. 3n

Ex-1004, Fig. 3n; Ex-1003, Ex-1003, ¶¶237-39. It would have been obvious to use Rusert’s PMV_CANDS as a merge list with Rusert’s PMV candidates as merge candidates in view of Zheng’s teachings. *Supra* §VI.A.1; Ex-1003, ¶¶240-41.

Rusert looks to whether the candidates are essentially similar by looking at whether they are duplicates or within a threshold distance. Ex-1004, ¶72

(excluding “new motion vectors... that are similar but not equal, such as pairs of motion vectors that have a similarity measure smaller than a pre-defined threshold...”); Ex-1003, ¶239.

8. Claim 7

7. The method according to claim 1 further comprising including a temporal motion prediction candidate into the merge list.

Ground 1 teaches claim 7. Ex-1003, ¶¶242-46. Ruser teaches that candidates in PMV_CANDS “may comprise spatial or *temporal* neighbors of the current block, or combinations of spatial and/or *temporal* neighbors.” Ex-1004, ¶67. Ruser further teaches that the motion vector may need scaling to adjust for the temporal difference in the current frame and the reference frame. *Supra* §V.B; Ex-1003, ¶¶244-45. A POSITA would have found it obvious to use Ruser’s PMV_CANDS as a merge list. *Supra* §VI.A.1, §VI.A.2[1c].

9. Claim 8

8. The method according to claim 1 comprising selecting one motion vector prediction candidate from the merge list to represent a motion vector prediction for the block of pixels.

Ground 1 teaches claim 8. Ex-1003, ¶¶247-53. Ruser teaches “signaling which PMV [candidate] is used for motion vector prediction[.]” Ex-1004, ¶84; *supra* §§VI.A.2[1c], [1g]. “[A] code ‘index’... is sent to *select* a particular PMV candidate... from a list of PMV candidates, PMV_CANDS”; the particular

candidate represents the candidate used for the current block of pixels. Ex-1004, ¶36; Ex-1003, ¶249.

Additionally, Ruser teaches exemplary codes to signal the index of the selected candidate from PMV_CANDS. Ex-1004, ¶¶88-102. Ruser applies the above teachings to “video decoding, wherein the current block is the block being... decoded” (Ex-1004, ¶23, ¶35) and is part of an “encoded video stream” that is “passe[d] to a decoder[.]” Ex-1004, ¶¶34-36; *supra* §VI.A.2[1g]; Ex-1003, ¶¶250-51. It would have been obvious to use Ruser’s PMV_CANDS as a merge list with Ruser’s PMV candidates as merge candidates in view of Zheng’s teachings. *Supra* §VI.A.1; Ex-1003, ¶¶252-53.

10. Claims 15 and 17

Beyond the preambles, claims 15 and 17 are nearly identical to claim 1, with limitations [15a]-[15g]/[17a]-[17g] having only minor differences with [1a]-[1g], respectively, and being satisfied for reasons explained above. *Supra* §§VI.A.2[1a]-[1g]; Ex-1003, ¶¶254-79.

[15pre] An apparatus comprising a processor and a memory including computer program code, the memory and the computer program code configured to, with the processor, cause the apparatus to:

[17pre] A non-transitory computer readable medium having stored thereon a computer executable program code for use by an encoder, said program codes comprise instructions for use by an encoder, said program code comprises instructions for:

Ground 1 teaches [15pre] and [17pre], e.g., with a video encoding/decoding “apparatus” comprising “a processor” and “computer-readable medium, carrying instructions, which when executed[,]... causes [the processor] to carry out any of the methods disclosed herein.” Ex-1004, ¶1, ¶¶24-27, ¶114, ¶116, claims 17-19; Ex-1003, ¶¶254-56, ¶¶267-69.

11. Claims 19-25

Beyond their preambles, claims 19-25 are identical to claims 2-8. Ground 1 teaches the preamble (apparatus of claim 15) (*supra* §VI.A.10) and the rest of claims 19-25 as explained for claims 2-8, respectively. *Supra* §§VI.A.3-9; Ex-1003, ¶¶280-86.

B. Ground 2:

1. Motivation to Combine

Nakamura is an H.265 proposal for “reduc[ing] the number of candidates in the spatial derivation process to reduce the number of... comparison[s] in the removal process.” Ex-1007, Abstract. When applied to WD4, Nakamura’s teachings satisfy the challenged claims. Ex-1003, ¶296.

A POSITA would have been motivated to apply Nakamura’s teachings to the draft H.265 standard because that was its express purpose. Nakamura was proposed at the 6th JCT-VC meeting for inclusion into the standard. WD4 was the output of that meeting, reflecting the state of the draft H.265 standard at that time. Nakamura proposed “simplifications” and “improvement[s]” to H.265. Ex-1007,

000001, §6. WD4 “[i]ncorporated spatial merge candidate positions unification” from Nakamura. Ex-1010, Abstract. There was clear motivation to apply Nakamura to WD4. Ex-1003, ¶¶296-98. This was a combination of prior art elements according to known methods to yield predictable results. Ex-1003, ¶¶299-300.

Ground 2 applies Nakamura’s known techniques to a known method (WD4) ready for improvement to yield predictable results. Nakamura teaches its “proposed technique is implemented into” the H.265 model software. Ex-1007, §2.3.1. Nakamura measured actual improvements from the combination. Ex-1007, §3; Ex-1003, ¶¶298-99, ¶303.

A POSITA would have been motivated by the references’ striking similarities and common purpose. Both are directed to H.265. Both derive motion vector prediction candidates, while seeking to reduce the number of candidates, for block-based inter-prediction. Ex-1010, §0.1, §0.6, §§8.4.2.1.1-8.4.2.1.3; Ex-1007, Abstract. WD4 provides context for Nakamura’s teachings. Ex-1010, §3, §8; Ex-1003, ¶¶301-03.

Nakamura references an earlier H.265 draft (WD3), which is expected because WD3 was the input to the meeting where Nakamura was proposed. This would not have dissuaded a POSITA from combining Nakamura with WD4, which

was the output of the meeting where Nakamura was presented. Ex-1014, ¶19; Ex-1049, ¶54; Ex-1003, ¶305.

The combination would not have changed the principle of operation for either reference. Nakamura was proposed for H.265, which WD4 teaches. Ex-1007, Abstract, §1, §6; Ex-1010, Abstract. Both operate on the same principles of block-based motion prediction. Ex-1023, 000004; Ex-1003, ¶304.

A POSITA would have had a reasonable expectation of success when combining Nakamura and WD4. Ground 2 combines Nakamura with an H.265 draft, as was intended. Nakamura implemented the combination and reported actual results showing performance gains. Ex-1007, §2.3.1, §3; Ex-1009, 000015-18. The combination does not modify Nakamura or WD4 in a way that would render either reference inoperative. A POSITA would have been more than capable of applying Nakamura's teachings to WD4, and vice-versa. Ex-1003, ¶¶306-07.

Nakamura is a single proposal comprising multiple files. A POSITA would have been motivated and had a reasonable expectation of success in combining the teachings of the Nakamura files (Ex-1007-1009) because they were jointly presented in a single proposal, by the same author, packaged in a single zip, and meant to be read together, teaching related aspects of Nakamura's proposal. Ex-1014; *supra* §III.B.3; Ex-1003, ¶¶308-09.

2. Claim 1

Nakamura satisfies claim 1 with its teachings regarding H.265 merge mode. Merge mode saved bits by utilizing predicted motion vectors without signaling difference vectors and other information used by MVP mode. Ex-1003, ¶313.

[1pre]

Ground 2 teaches [1pre], e.g., “improvement of derivation method of the candidates for merge mode” comprising the below-described steps. Ex-1007, §1, Abstract, §2.1, Fig. 1; Ex-1010, §8.4.2.1.2, §8.4.2.1.8; *infra* §§VI.B.2[1a]-[1g]; Ex-1003, ¶¶310-13.

[1a]

Receiving a block of pixels including a prediction unit. WD4 teaches “allow[ing] motion video to be... transmitted and received.” Ex-1010, §0.2. WD4 explains that the encoder transmits the video to a decoder via a bitstream. Ex-1010, §3.11. That bitstream represents an encoded version of the frame of the video that is divided into blocks of pixels, which include PUs. Ex-1010, §0.2, §3.11, §3.12, §3.21, §3.34, §3.38, §7.3.7; Ex-1003, ¶315.

[1b]

Ground 2 teaches [1b]. Ex-1003, ¶¶317-22.

Determining a set of spatial motion vector prediction candidates for the block of pixels. Nakamura identifies two spatial motion vector prediction

candidates (S_0 and S_1) from a set of motion vector candidates from “the position[s] of the spatial neighbors A, B, C, D and E relative to the current prediction unit” which “can be used for... candidates” for the current block. Ex-1007, §2.2.1, Abstract, §1, Tables 2, 4, Figure 1; Ex-1009, 000008, 000010, 000014. The candidates are spatial motion vector prediction candidates because each is a candidate motion vector obtained from one or more previously-encoded blocks in the current frame (A–E). *E.g.*, Ex-1007, §2.2.1; *supra* §V.A. The spatial neighbors are blocks A–E:

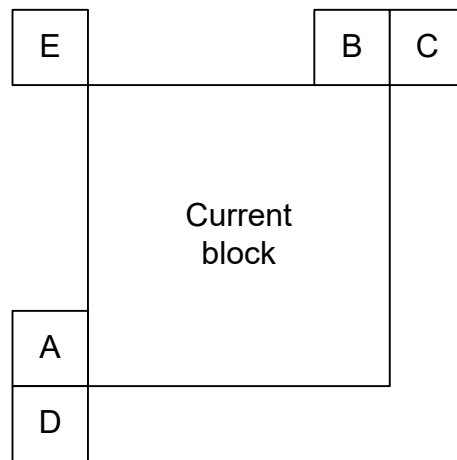

(b) Proposed technique

Ex-1007, Figure 2(b); Ex-1003, ¶314. Blocks A-E represent blocks that have already been encoded due to the raster scan processing of the frame. *See* Ex-1010, §3.83 (explaining “raster scan”), §3.101; Ex-1003, ¶318. WD4 explicitly states that its teachings are applicable to both the encoding and decoding process.

Ex-1010, §3.34, §3.38; Ex-1003, ¶¶319-20.

The spatial motion vector prediction candidates being provided with motion information. Each spatial motion vector prediction candidate comprises “availability flags... reference indices... prediction list utilization flags...” and “*motion vectors*” for prediction. Ex-1008, §8.4.2.1.2; Ex-1010, §8.4.2.1.2. Motion vectors are motion information that is used in the “decoding process for prediction units” to derive the “samples” (e.g., pixels) for a block of pixels. Ex-1010, §8.4.2, §3; Ex-1003, ¶321.

[1c]

Selecting a first spatial motion vector prediction candidate from the set of spatial motion vector prediction candidates. Nakamura teaches identifying two spatial motion vector prediction candidates for a merge list, i.e., “spatial candidate[s]” S_0 and S_1 , from “the position[s] of the spatial neighbors A, B, C, D and E relative to the current prediction unit” which “can be used for... candidates[.]” Ex-1007, §2.2.1, Abstract, §1, Tables 2, 4, Fig. 1; Ex-1009, 000008, 000010, 000012-14. The selection of a candidate from a spatial neighbor for S_1 satisfies the claimed step for selecting a first⁸ spatial motion vector prediction

⁸ Nakamura refers to S_1 as a second candidate. It is irrelevant whether Nakamura applies its own “first” and “second” labels or whether any other

candidate from the set of candidates. Ex-1003, ¶324. S_0 and S_1 are spatial motion vector prediction candidates because each is a candidate motion vector obtained from one or more previously-coded blocks in the current frame (A-E). *Supra* §V.A, §VI.B.2[1b]; Ex-1007, §2.2.1; Ex-1003, ¶324.

Selecting a first... candidate... as a potential spatial motion vector prediction candidate to be included in a merge list for the prediction unit. A “merging candidate list is constructed of two spatial merging candidates” (S_0 and S_1) selected in a “[s]patial derivation order” from the five spatial neighbor candidates “relative to the current prediction unit[.]” Ex-1007, §2.2.1, Tables 2-4; Ex-1008, §8.4.2.1.1; Ex-1009, 000008, 000010, 000012-14. Following the spatial derivation order, Nakamura steps through blocks A–E until two spatial candidates (S_0 and S_1) are selected for potential inclusion in the merging candidate list. Ex-1009, 000008; Ex-1007, §2.2.1, Table 2; Ex-1003, ¶¶325-27.

candidates come before S_1 because claim 9 merely recites “a first” candidate to distinguish it from other candidates, not as an absolute temporal requirement. Ex-1003, ¶324.

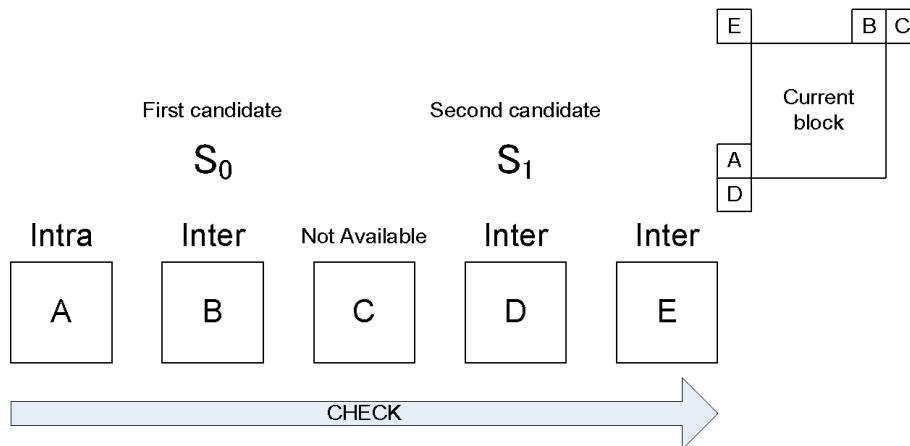

7

Ex-1009, 000008. The merging candidate list is a merge list for the PU.

Nakamura teaches that one candidate in its merging candidate list is assigned as the motion vector for the PU. Ex-1008, §8.4.2.1.1; Ex-1003, ¶¶328-29.

Where the merge list is constructed based on the motion information of the spatial motion vector prediction candidates. The “merging candidate list is constructed of” spatial candidates (Ex-1007, §2.2.1) and includes information of those candidates in the list, including “availability flags... reference indices... prediction list utilization flags...” and “motion vectors[.]” Ex-1008, §8.4.2.1.2; Ex-1010, §8.4.2.1.2; Ex-1003, ¶330.

Motion information... is utilized to identify motion vector prediction candidates of which one spatial motion vector prediction candidate from the merge list is signaled as the motion information for the prediction unit. WD4 teaches a merge index (e.g., “merge_idx”) that “specifies the merging candidate index of the merging candidate list[.]” Ex-1010, §7.4.7. The transmitted merge_idx is information sent by the encoder and used by the decoder to select the correct candidate to use for decoding and reconstructing the PU. Ex-1010, §8.4.2.1.1; §7.3.7 (red square highlights added; other markings in original); Ex-1003, ¶331.

	Descriptor
prediction_unit(x0, y0, log2PUWidth, log2PUHeight, PartIdx) {	
if(skip_flag[x0][y0]) {	
merge_idx [x0][y0]	ue(v) ae(v)
} else if(PredMode == MODE_INTRA) {	
if(PartMode == PART_2Nx2N && log2CUsSizePUWidth >= Log2MinIPCMCUsSize)	
pcm_flag	u(1) ae(v)
if(pcm_flag) {	
while (!byte_aligned())	
pcm_alignment_zero_bit	u(v)
for(i = 0; i < 1 << (log2CUsSize << 1); i++)	
pcm_sample_luma [i]	u(v)
for(i = 0; i < (1 << (log2CUsSize << 1)) >> 1; i++)	
pcm_sample_chroma [i]	u(v)
} else {	
prev_intra_luma_pred_flag [x0][y0]	u(1) ae(v)
if(prev_intra_luma_pred_flag[x0][y0])	
if(NumMPMCand > 1)	
mpm_idx [x0][y0]	u(1) ae(v)
else	
rem_intra_luma_pred_mode [x0][y0]	ce(v) ae(v)
if(IntraPredMode[x0][y0] == 2)	
planar_flag_luma [x0][y0]	u(1) ae(v)

<code>intra_chroma_pred_mode[x0][y0]</code>	<code>ue(v) ae(v)</code>
<code>SignaledAsChromaDC = (chroma_pred_from_luma_enabled_flag ? intra_chroma_pred_mode[x0][y0] == 3 : intra_chroma_pred_mode[x0][y0] == 2)</code>	
<code>if(IntraPredMode[x0][y0] != 2 && IntraPredMode[x0][y0] != 34 && SignaledAsChromaDC)</code>	
<code>planar_flag_chroma[x0][y0]</code>	<code>u(1) ae(v)</code>
<code>}</code>	
<code>} else { /* MODE_INTER */</code>	
<code>if(entropy_coding_mode_flag PartMode != PART_2Nx2N)</code>	
<code>merge_flag[x0][y0]</code>	<code>u(1) ae(v)</code>
<code>if(merge_flag[x0][y0]) {</code>	
<code>merge_idx[x0][y0]</code>	<code>ue(v) ae(v)</code>
<code>} else {</code>	
<code>if(slice_type == B) {</code>	
<code>if(!entropy_coding_mode_flag) {</code>	
<code>combined_inter_pred_ref_idx</code>	<code>ue(v)</code>
<code>if(combined_inter_pred_ref_idx == MaxPredRef)</code>	
<code>inter_pred_flag[x0][y0]</code>	<code>ue(v)</code>
<code>} else</code>	
<code>inter_pred_flag[x0][y0]</code>	<code>ue(v) ae(v)</code>
<code>}</code>	
<code>if(inter_pred_flag[x0][y0] == Pred_LC) {</code>	
<code>if(num_ref_idx_lc_active_minus1 > 0) {</code>	

Merge mode is signaled by the encoder to the decoder via the `merge_flag`.

Ex-1010, §7.4.7. The PU is encoded into the bitstream that is received by a decoder. Ex-1010, §7.3.7, §0.2, §3.11, §3.12, §3.34, §3.38. Ex-1003, ¶331.

The merge list, which WD4 refers to as `mergeCandList`, is constructed by both the encoder and decoder, as part of the encoding and decoding process, respectively. Ex-1008, §8.4.2.1.1; Ex-1010, §7.3.7, §7.4.7, §8.4.2.1.1; Ex-1003, ¶334. The `merge_idx` is selected by the encoder and is information encoded for a PU, based on the merge list, that is then used by the decoder during the decoding process. The `merge_idx` points to a specific merging candidate used for predicting

the motion vector for the current block. Ex-1008, §8.4.2.1.1; Ex-1010, §7.3.7, §7.4.7, §8.4.2.1.1; Ex-1003, ¶¶331-32.

The merge_idx is information received by WD4's decoder to identify the correct spatial motion vector prediction candidate from the merge list as signaled by the encoder, to be used for decoding the encoded block of pixels. Ground 2 teaches, or at least suggests, that the decoder receives merge_idx as selected by the encoder when encoding the bitstream, for use in decoding. Ex-1010, §3.11, §3.12, §3.34, §3.38, §8.4.2.1.1; Ex-1003, ¶¶334-35.

[1d]

Ground 2 teaches [1d]. Ex-1003, ¶¶337-45.

Determining a subset of spatial motion vector prediction candidates.

Nakamura teaches “[t]wo spatial merging candidates” (S_0 , S_1) “are derived in the spatial derivation process[.]” from five “spatial neighbors A, B, C, D, and E relative to the current prediction unit[.]” Ex-1007, §2.2.1, Tables 1, 2, 4; Ex-1009, 000008, 000010, 000014; *supra* §V.D. For S_1 , Nakamura teaches a subset (S_0) with which S_1 is compared to determine whether to include or exclude S_1 . Ex-1007, Tables 2, 4; Ex-1008, §8.4.2.1.1; Ex-1009, 000010, 13; Ex-1010, §8.4.2.1.1; Ex-1003, ¶¶338-39.

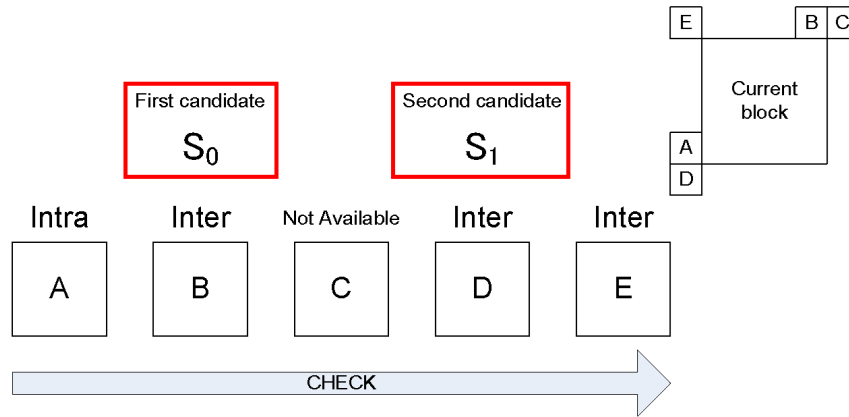

7

Ex-1009, 000008.

Based on a location of the block associated with the first spatial motion vector prediction candidate. The subset is determined from a set of “spatial neighbors A, B, C, D and E relative to the current prediction unit” for the current block. Ex-1007, §2.2.1, Fig. 2(b); Ex-1009, 000008. Additionally, the subset (S_0) is based on the location of S_1 following Nakamura’s spatial derivation order, which is based on relative positions of blocks around the current block. Ex-1007, §2.2.1, Fig. 2; Ex-1008, §8.4.2.1.2, Fig. 8-3; Ex-1009, 000008, 000010; Ex-1003, ¶¶340-44.

[1e]

Ground 2 teaches [1e]. Ex-1003, ¶¶346-53.

Comparing motion information of the first spatial motion vector prediction candidate (e.g., for S_1) with motion information of spatial motion vector prediction candidates (e.g., for S_0) in the determined subset of spatial motion vector prediction candidates (e.g., the subset comprising S_0),... wherein comparing comprises performing an equivalence check or comparing a difference in motion information to a threshold or other similarity metric.

Nakamura compares the spatial candidates (S_0 and S_1) to “[r]emove candidates with the same motion information[.]” Ex-1007, Fig. 1, Table 4, Table 2. Ex-1003, ¶¶347-49. Nakamura compares motion information, which includes “motion vectors” and “reference indices[.]” (Ex-1010, §8.4.2.1.1) and uses an equivalence check to “[r]emove candidates with the same motion information” when the candidates are identified for potential inclusion in the merge list. Ex-1007, Fig. 1, Table 4, Table 2; Ex-1003, ¶¶350-51.

Comparing... without making a comparison of each possible candidate pair from the set of spatial motion vector prediction candidates. Nakamura compares S_0 with S_1 without making a comparison of each possible candidate pair from the set of candidates from blocks A–E. Ex-1007, Tables 1-2, 4; Ex-1009, 000009-10, 000014. Reducing “[t]he number of candidates... in the spatial derivation process... reduce[s] the number of times of comparison in the removal process.” Ex-1007, §2.2.1, Table 1; Ex-1003, ¶352.

[1f]

Ground 2 teaches [1f]. Ex-1003, ¶¶354-56.

If at least one of the comparisons indicates that the motion vector information of the spatial motion vector prediction candidates correspond with each other, excluding the first spatial motion vector prediction candidate from the merge list. Nakamura determines whether to exclude the selected first spatial motion vector prediction candidate from the merge list, based on comparing motion information for the first spatial motion vector prediction candidate (S_1) with another spatial motion vector prediction candidate (S_0). Ex-1007, Fig. 1, Tables 2, 4; Ex-1010, §8.4.2.1.1; *supra* §§VI.B.2[1c], [1e]. When the motion information of S_1 and S_0 are the same, S_1 is excluded from the merging candidate list. Ex-1010, §8.4.2.1.1; Ex-1003, ¶355.

[1g]

Causing information identifying the one spatial motion vector prediction candidate from the merge list to be transmitted to a decoder or to be stored. WD4 teaches a merge index (e.g., “merge_idx”) that specifies “specifies the merging candidate index of the merging candidate list[.]” Ex-1010, §7.4.7.” Based on the merge_idx, one spatial candidate “at position merge_idx[xP][yP] in the merging candidate list mergeCandList” is assigned as the

spatial candidate to use for prediction of the current block and is transmitted to the decoder for use. Ex-1010, §8.4.2.1.1; *supra* §V.B.2[1c]; Ex-1003, ¶358.

WD4 also teaches that `merge_idx` is information that identifies the merging candidate from the merging candidate list, which is then used by the decoder to select the specified merging candidate's motion information from the merge list to be used as the motion vector predictor for reconstructing the block. Ex-1010, §8.4.2.1.1; Ex-1003, ¶359-60.

3. Claim 2

2.

Ground 2 teaches claim 2. Ex-1003, ¶¶362-66. Nakamura teaches selecting a spatial motion vector prediction candidate according to its spatial derivation order. *Supra* §VI.B.2[1c]. Nakamura explains that its scan order is in a predetermined order. Ex-1007, Table 2-4; Ex-1009, 000008, 000010, 000012-14. Nakamura illustrates an example of the “[s]patial derivation order” which starts from A and progresses to E. Ex-1009, 000008:

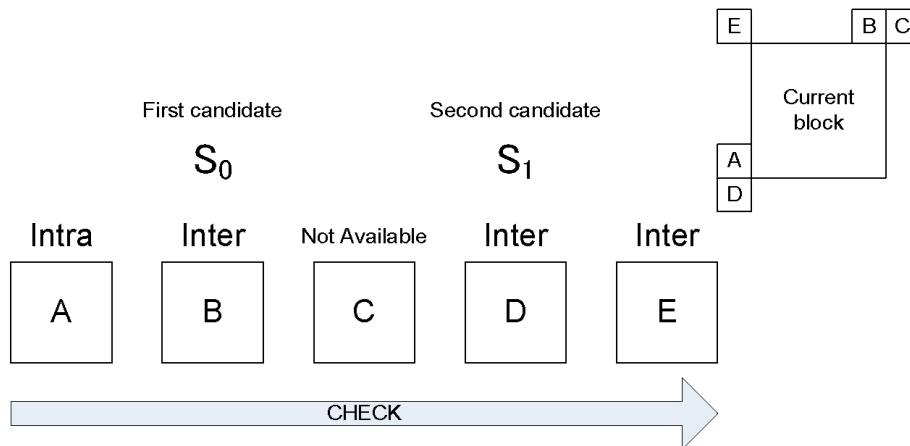

7

Ex-1003, ¶¶364-65.

4. Claim 3

3.

Ground 2 teaches claim 3. Ex-1003, ¶¶367-71. Nakamura teaches comparing motion information of S_1 with at most S_0 to “[r]emove candidates with the same motion information[.]” Ex-1007, Fig. 1, Tables 2, 4; *supra* §VI.B.2[1e]. Potential spatial motion vector prediction candidate S_1 is only compared to one S_0 because “[t]he merging candidate list is constructed of two spatial merging candidates[.]” Ex-1007, §2.2.1, Table 2; Ex-1003, ¶¶367-70.

5. Claim 4

4.

Ground 2 teaches claim 4. Ex-1003, ¶¶372-82. Ground 2 teaches examining the received block of pixels, which is the current block. Ex-1010, §0.2, §§3.11-3.12, §3.34, §3.38; Ex-1007, §2.2.1, Fig. 2; *supra* §VI.B.2[1a].

Nakamura and WD4 exclude a spatial candidate by setting it as unavailable with “availableFlagN is set equal to 0[,]” if the current block is divided into two PUs horizontally (“PartMode of the current prediction unit is PART_2NxN”) or vertically (“PART_Nx2N”). Ex-1008, §8.4.2.1.2; Ex-1010, §8.4.2.1.2; *supra* §I.B (explaining partition notation); Ex-1003, ¶373.

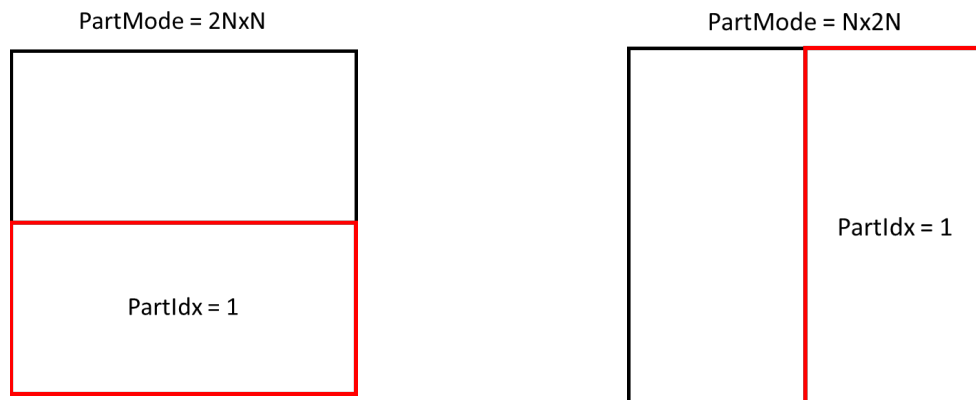

Ex-1003, ¶374. Nakamura checks if the PU is the second PU (“PartIdx is equal to 1”) of the divided block, and if so, excludes the potential spatial motion vector prediction candidate from the merge list. Ex-1008, §8.4.2.1.2; Ex-1003, ¶¶374-75.

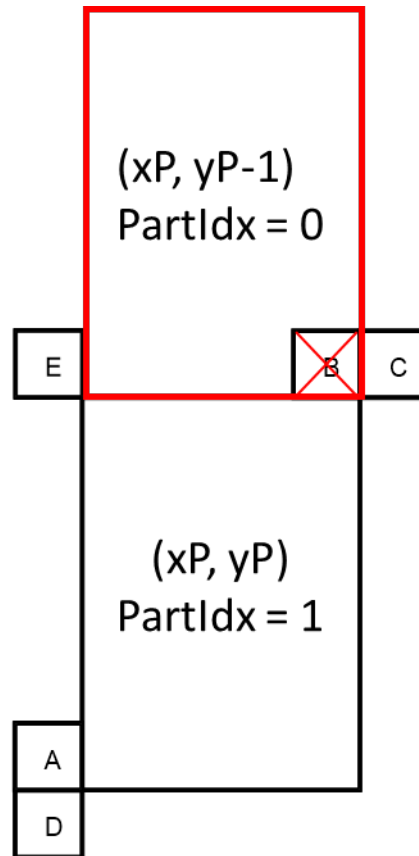

Ex-1003, ¶376. For the 2NxN (horizontally-divided) scenario, Nakamura sets the spatial candidate for block B (“prediction unit[] covering luma location (xP, yP-1) (PartIdx=0)”) and any other spatial candidate that has “identical motion parameters[]” as block B to unavailable (e.g., setting availableFlagB “equal to 0”), which excludes it from the merge list. Ex-1008, §8.4.2.1.2; Ex-1010, §8.4.2.1.2. The coordinates “(xP, yP-1)” refers to the block above the current block (same x coordinate; 1 block up). Block B has “PartIdx=0” because it is above the current block (PartIdx=1) in this vertically-divided block. Ex-1003, ¶¶376-78.

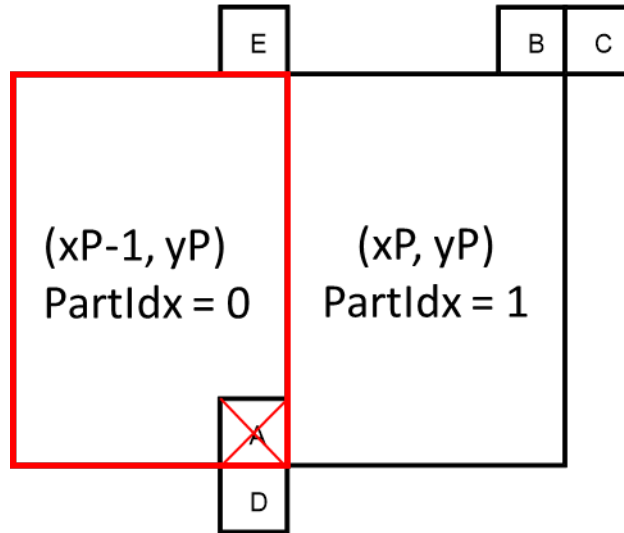

Ex-1003, ¶379. Similarly, for the $N \times 2N$ (vertically-divided) scenario, Nakamura sets the spatial candidate for block A referring to the block on the left and any other spatial candidate that has “identical motion parameters[]” as block A to unavailable (e.g., `availableFlagA` “equal to 0”), which excludes it from the merge list. Ex-1008, §8.4.2.1.2; Ex-1010, §8.4.2.1.2. The coordinates “ (x_{P-1}, y_P) ” refers to the block left of the current block (same y coordinate; 1 block left). Block A has “ $\text{PartIdx}=0$ ” because it is to the left of the current block ($\text{PartIdx}=1$). *Id.*; Ex-1003, ¶¶379-81.

6. Claim 5

[5pre]

Ground 2 teaches [5pre]. *Supra* §VI.B.2; Ex-1003, ¶383.

[5a]

Ground 2 teaches [5a]. Ex-1003, ¶¶384-88. Nakamura teaches “[t]he merging candidate list is constructed of two spatial merging candidates” for a maximum number of two. Ex-1007, §2.2.1, Tables 1-2, 4; Ex-1009, 000008; *supra* §VI.B.2[1d]. Furthermore, Nakamura teaches checking a maximum number of four candidates for the merging candidate list. Ex-1008, §8.4.2.1.1 (checking A-D); Ex-1010, §8.4.2.1.2. If four candidates are available, the fifth is not checked. Ex-1003, ¶¶385-88.

[5b]

Ground 2 teaches [5b]. Ex-1003, ¶¶389-94. Nakamura limits the number of spatial motion vector prediction candidates in the merging candidate list to be smaller or equal to the maximum number two because no further candidates are included. *Supra* §VI.B.6[5a]; Ex-1007, Table 3, Table 4; Ex-1009, 000008. Furthermore, Nakamura teaches limiting the number of checked candidates to four; if so, skipping the fifth candidate (E). Ex-1008, §8.4.2.1.1; Ex-1010, §8.4.2.1.2; *supra* §VI.B.6[5a]; Ex-1003, ¶¶390-94.

7. Claim 6

[6pre]

Ground 2 teaches [6pre]. *Supra* §VI.B.6; Ex-1003, ¶395.

[6a]

Ground 2 teaches [6a]. Ex-1003, ¶¶396-99. Nakamura examines if the number of spatial candidates in “[t]he merging candidate list is” smaller than a maximum of “two spatial merging candidates[.]” Ex-1007, §2.2.1, Tables 1-2, 4; Ex-1009, 000008; *supra* §VI.B.6. “NumMergeCand” represents the “number of elements... within the mergeCandList[.]” Ex-1008, §8.4.2.1.1; Ex-1003, ¶¶397-99.

[6b]

Ground 2 teaches [6b]. Ex-1003, ¶¶400-02. Nakamura and WD4 both teach examining whether the PU to which the potential spatial motion vector prediction candidate belongs is available for motion prediction, so as to exclude the candidate when unavailable. “For the derivation of availableFlagN, with N being A, B, C, D or E... the availableFlagN is set equal to 0[.]” or unavailable, if “[t]he prediction unit... is not available[.]” Ex-1008, §8.4.2.1.2; Ex-1010, §8.4.2.1.2 (teaching same concept). This occurs if the number of spatial candidates in the merging candidate list is at the maximum because no further candidates are examined when the maximum is reached. *Supra* §VI.B.6[5b]; Ex-1003, ¶401.

[6c]-[6h]

Ground 2 teaches [6c]-[6h]. Ex-1003, ¶¶403-14. Ground 2 teaches receiving a block of pixels, which is the current block. Ex-1010, §0.2, §3.11, §3.12, §3.34, §3.38; Ex-1007, §2.2.1, Fig. 2; *supra* §VI.B.2[1a].

For [6c]-[6f], for a vertically-divided block (“PartMode is... PART_Nx2N”) where the potential candidate is on the left of the PU for the current block (PartIdx=1), Nakamura iterates through neighboring blocks, including Block A, and excludes the PU on the left and any other block that has “identical motion parameters” with Block A from the merging candidate list by setting their availability (“availableFlagN”) to zero, illustrated below. Ex-1008, §8.4.2.1.2 (excluding Block A which has identical parameters with itself); Ex-1010, §8.4.2.1.2. Nakamura does this if the current block is vertically divided into first and second PUs (“PART_Nx2N”). *Supra* §VI.B.5, §I.B (explaining partition modes); Ex-1003, ¶¶405-08.

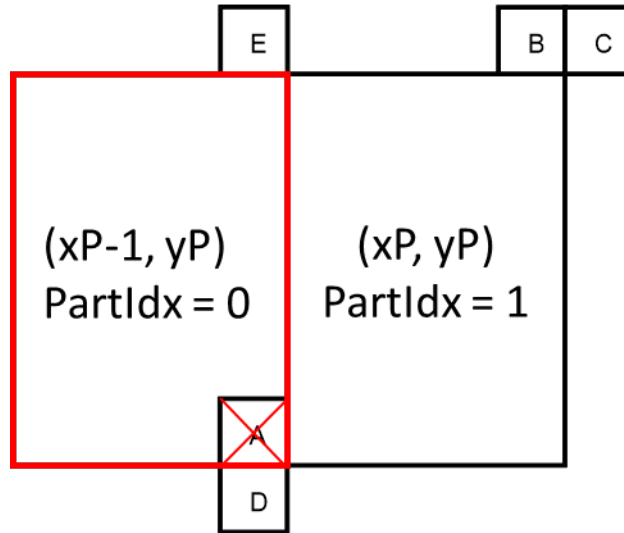

Ex-1003, ¶406.

For [6g]-[6h], for a horizontally-divided block (“PartMode... is PART_2NxN”) where the potential candidate is above the PU for the current block (PartIdx=1), Nakamura iterates through neighboring blocks, including Block B, and excludes Block B and any other block that has “identical motion parameters” from the merging candidate list by setting their availability (“availableFlagN”) to zero, illustrated below. Ex-1008, §8.4.2.1.2; Ex-1010, §8.4.2.1.2. Nakamura does this if the current block is horizontally divided into first and second PUs (“PART_2NxN”). *Supra* §VI.B.5, §I.B; Ex-1003, ¶¶410-13.

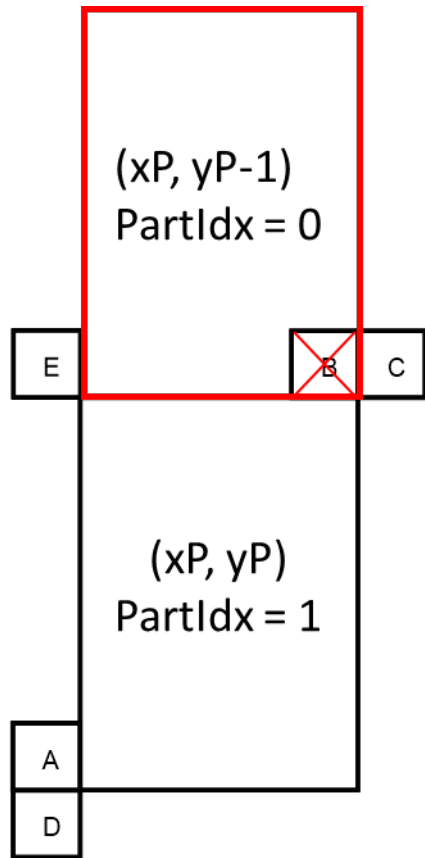

Ex-1003, ¶411.

The above exclusions only occur if the PU on the left (for vertically-divided blocks) or above (for horizontally-divided blocks) is available for motion prediction because otherwise, it would already be marked as unavailable. *Supra* §VI.B.7[6b]; Ex-1003, ¶408, ¶413.

8. Claim 7

7.

Ground 2 teaches claim 7. Ex-1003, ¶¶415-18. Nakamura teaches that “[t]he merging candidate list is constructed of two spatial merging candidates and a *temporal* merging candidate.” Ex-1007, §2.2.1, Table 2, Figure 1(a); Ex-1009,

000010. Nakamura’s Figure 1(a) illustrates that the “Temporal Derivation Process” is meant to “derivate a temporal merging candidate” followed by a “LIST CONSTRUCTION PROCESS” that “constructs the merging candidate list.”

Supra §V.B; Ex-1007, Figure 1(a).

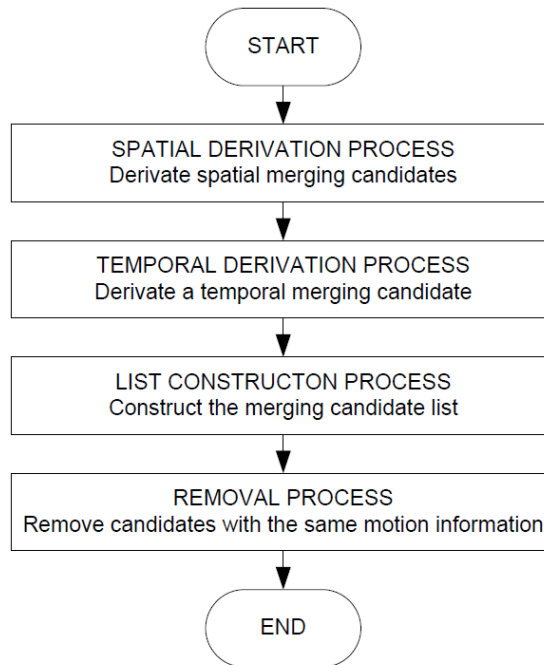

(a) Derivation Process for merge mode

Ex-1007, Figure 1(a); Ex-1003, ¶417.

9. Claim 8

8.

Ground 2 teaches claim 8. Ex-1003, ¶¶419-24. WD4 teaches a merge index (“merge_idx”) that “specifies the merging candidate index of the merging candidate list[.]” Ex-1010, §7.4.7; *supra* §§VI.B.2[1c], [1g]. The “candidate at

position merge_idx[xP][yP] in the merging candidate list mergeCandList” is selected to represent a motion vector prediction for the current block of pixels.

Ex-1010, §8.4.2.1.1; *supra* §§VI.B.2[1c], [1g]; Ex-1003, ¶¶421-23.

10. Claims 15 and 17

Beyond the preambles, claims 15 and 17 are nearly identical to claim 1, with limitations [15a]-[15g]/[17a]-[17g] having minor differences with [1a]-[1g], respectively, and are satisfied as explained above. *Supra* §§VI.B.2[1a]-[1g]; Ex-1003, ¶¶425-46.

[15pre]

[17pre]

Ground 2 teaches [15pre] and [17pre]. Nakamura teaches an encoder “for encoding experiments” that comprises a “CPU” and “[m]emory[.]” Ex-1007, Table 5. WD4 also teaches “video decoders” with various “processing load and memory capability[.]” for implementing its teachings. Ex-1010, Annex A. Their teachings were “implemented into” software such as “HM3.0 software[.]” Ex-1007, §2.3.1, §3.3.3, Tables 7-12; Ex-1010, §0.5, §3.31, 000003, §8.3.3.1.8; Ex-1003, ¶¶425-28, ¶¶436-39.

11. Claims 19-25

Beyond their preambles, claims 19-25 are identical to claims 2-8. Ground 2 teaches the preamble (*supra* §VI.B.10) and the rest of claims 19-25 as explained for claims 2-8, respectively. *Supra* §§VI.B.3-9; Ex-1003, ¶¶447-53.

VII. DISCRETIONARY ANALYSIS

Fintiv. Denial is unwarranted because this Petition's merits are compelling. *See* June 21, 2022 Memorandum, 3-5. No case management conference has occurred and no case schedule has issued in the parallel district court case. This is the only IPR filed against the challenged claims to date. *General Plastic* factors do not weigh against institution.

Advanced Bionics. Denial under §325(d) is unwarranted because Rusert and Zheng are not cited by the '833 patent. WD4 and Nakamura's 10-page document (Ex-1007) are cited (Ex-1002, 000896 (No. 2 "10 pages")), but there is no evidence the full reference—which also includes Nakamura's WD (Ex-1008) and Presentation (Ex-1009)—was considered.

The Office has never considered the allowability of the '833 patent in view of Rusert. Rusert's identification for a *later*-filed continuation does not change this fact. On June 7, 2021, over 4-years after the '833 patent issued, Nokia submitted an IDS that identified a Rusert family member among 43 other references. Ex-1053, 000151-53. That application issued with different claim scope than the

'833 patent, and, for example, did not include the reduced-comparison limitation (“without making a comparison of each pair from the set of spatial motion vector prediction candidates”) that the Examiner cited as the reason for allowance for the '833 patent. Ex-1002, 001045. Therefore, the Examiner had no reason to consider Rusert’s reduced-comparison teachings that are relied on here.

BD Factors (a), (b), and (d) weigh against denial because Rusert and Zheng (Ground 1) were not considered during prosecution of the '833 patent. Rusert is materially different from the cited art because it teaches a dynamically-constructed PMV_CANDS list using reduced comparisons (*supra* §VI.A.2[1e]), which was never before the Examiner during prosecution of the '833 patent.

For Ground 2, nothing in the file history indicates that the *full* Nakamura reference was considered. Moreover, even if cited, the references were never discussed and the combination of Nakamura and WD4 was never considered. Ex-1002, 000266, 000896 (citing WD4 and 10-page Nakamura in different IDS forms 7 months apart). Ground 2 is not the same or substantially the same as the art or arguments that were previously presented.

Factor (d) weighs against denial because the arguments made during prosecution do not overlap with Petitioner’s arguments. Grounds 1-2 were not previously considered. None of the Examiner’s rejections used a Rusert-like

reference that taught reduced comparisons. None used Nakamura, WD4, or combinations based on those references.

BD Factors (c), (e), and (f) weigh strongly against denial. The allowance of the '833 patent was in error because Rusert and Nakamura both teach the reduced-comparison limitation cited as the reason for allowance (*supra* §VI.A.2[1e], §VI.B.2[1e]), yet none of these references were the basis of an Office Action rejection. Thus, the Examiner erred by overlooking the material teachings of these references. *See Snap, Inc. v. Playvuu, Inc.*, IPR2023-00848, Paper 12, 12-16 (PTAB December 6, 2023) (finding error when Examiner “overlooked, or did not appreciate, the materiality of [prior-art] references”); *Samsung Electronics Co., Ltd. v. Evolved Wireless LLC*, IPR2021-00943, Paper 9 at 10-12 (PTAB Dec. 1, 2021) (no denial when file history provides little insight into the Examiner’s evaluation of art). Rusert’s and Nakamura’s teachings are directly relevant to the alleged point of novelty, and therefore not cumulative of the art cited during prosecution, which do not teach this limitation. *Supra* §II.A.

Factor (f) weighs against denial because the Petition presents testimony from Dr. Creusere explaining Rusert, Nakamura, and the H.264/H.265 standards, which was not before the Examiner.

VIII. MANDATORY NOTICES AND FEES

1. **Real Party In Interest:** The real parties-in-interest here are Amazon.com, Inc. and Amazon.com Services, LLC. No other parties directed, controlled, or funded this Inter Partes Review proceeding (IPR).

2. **Related Matters:**

- *Nokia Corporation and Nokia Technologies Oy v. Amazon.com, Inc. and Amazon.com Services, LLC*, Case No. 1:23-cv-01236 (D. Del.)
- *Amazon.com, Inc. v. Nokia Technologies Oy*, IPR2024-01503 (PTAB)
- *Nokia Corporation and Nokia Technologies Oy v. Amazon.com, Inc. and Amazon.com Services, LLC*, Case No. 1:23-cv-01232 (D. Del.) (Related Patent – US Pat. No. 10,536,714)
- *Nokia Technologies Oy, v. HP, Inc.*, 1:23-cv-01237 (D. Del.) (Related Patent – US Pat. No. 10,536,714)
- Certain Video Capable Electronic Devices, Including Computers, Streaming Devices, Televisions, and Components and Modules Thereof; Inv. No. 337-TA-1380 (ITC) (Related Patent – US Pat. No. 10,536,714)

- *Amazon.com, Inc. v. Nokia Technologies Oy*, IPR2024-00604 (PTAB) (Related Patent – US Pat. No. 10,536,714)
- *Amazon.com, Inc. v. Nokia Technologies Oy*, IPR2024-00605 (PTAB) (Related Patent – US Pat. No. 10,536,714)

3. Lead and Backup Counsel: Pursuant to 37 C.F.R. §42.8(b)(3) and 42.10(a), Petitioner designates Harper Batts (Reg. No. 56,160) as lead counsel and Chris Ponder (Reg. No. 77,167), Jeffrey Liang (Reg. No. 69,043) and James Young Hurt (Reg. No. 79,121) as back-up counsel, each of Sheppard, Mullin, Richter & Hampton LLP.

4. Service Information: Petitioner consents to service by electronic mail addressed to:

HBatts@sheppardmullin.com;

CPonder@sheppardmullin.com;

JLiang@sheppardmullin.com;

JHurt@sheppardmullin.com; and

LegalTM-Amazon-Nokia-IPRs@sheppardmullin.com

Petitioner's counsel may also be served by mail or hand delivery at Sheppard, Mullin, Richter & Hampton LLP, 1540 El Camino Real Suite 120, Menlo Park, CA 94025. Petitioner's counsel may be reached by telephone at (650) 815-2673 and by facsimile at (650) 815-4668.

5. **Fees:** The Office is authorized to charge fees for this Petition to Deposit Account 50-4561, Ref. 19AG-385608.

Respectfully submitted,

SHEPPARD, MULLIN,
RICHTER & HAMPTON LLP

/Harper Batts/

Harper Batts (Reg. No. 56,160)
Attorneys for Petitioner

CLAIM APPENDIX

[1pre] A method comprising:

[1a] receiving a block of pixels including a prediction unit;

[1b] determining a set of spatial motion vector prediction candidates for the block of pixels; the spatial motion vector prediction candidates being provided with motion information;

[1c] selecting a first spatial motion vector prediction candidate from the set of spatial motion vector prediction candidates as a potential spatial motion vector prediction candidate to be included in a merge list for the prediction unit, where the merge list is constructed based on the motion information of the spatial motion vector prediction candidates and is utilized to identify motion vector prediction candidates of which one spatial motion vector prediction candidate from the merge list is signaled as the motion information for the prediction unit;

[1d] determining a subset of spatial motion vector prediction candidates based on a location of the block associated with the first spatial motion vector prediction candidate;

[1e] comparing motion information of the first spatial motion vector prediction candidate with motion information of spatial motion vector prediction candidates in the determined subset of spatial motion vector prediction candidates

without making a comparison of each possible candidate pair from the set of spatial motion vector prediction candidates, wherein comparing comprises performing an equivalence check or comparing a difference in motion information to a threshold or other similarity metric;

[1f] if at least one of the comparisons indicates that the motion vector information of the spatial motion vector prediction candidates correspond with each other, excluding the first spatial motion vector prediction candidate from the merge list; and

[1g] causing information identifying the one spatial motion vector prediction candidate from the merge list to be transmitted to a decoder or to be stored.

2. The method according to claim 1 comprising selecting spatial motion vector prediction candidates from the set of spatial motion vector prediction candidates as the potential spatial motion vector prediction candidate in a predetermined order.

3. The method according to claim 1, comprising comparing motion information of the potential spatial motion vector prediction candidate with motion information of at most one other spatial motion vector prediction candidate of the set of spatial motion vector prediction candidates.

4. The method according to claim 1 comprising examining whether the received block of pixels is divided into a first prediction unit and a second prediction

unit; and if so, excluding the potential spatial motion vector prediction candidate from the merge list if the prediction unit is the second prediction unit.

[5pre] The method according to claim 1, further comprising

[5a] determining a maximum number of spatial motion vector prediction candidates to be included in a merge list; and

[5b] limiting the number of spatial motion vector prediction candidates in the merge list smaller or equal to the maximum number .

[6pre] The method according to claim 5 comprising:

[6a] examining, if the number of spatial motion vector prediction candidates in the merge list smaller than the maximum number;

[6b] if so, examining whether the prediction unit to which the potential spatial motion vector prediction candidate belongs is available for motion prediction;

[6c] if so, performing at least one of the following:

[6d] for a potential spatial motion vector prediction candidate on a left side of the prediction unit, excluding the potential spatial motion vector prediction candidate from the merge list if any of the following conditions are fulfilled:

[6e] the received block of pixels is vertically divided into a first prediction unit and a second prediction unit;

[6f] the received block of pixels is horizontally divided into a first prediction unit and a second prediction unit, and if the prediction unit is the second prediction unit, and the potential spatial motion vector prediction candidate has essentially similar motion information than a spatial motion vector prediction candidate above the prediction unit;

[6g] for a potential spatial motion vector prediction candidate above the prediction unit, excluding the potential spatial motion vector prediction candidate from the merge list if any of the following conditions are fulfilled:

[6h] the received block of pixels is horizontally divided into a first prediction unit and a second prediction unit, and the prediction unit is the second prediction unit;

[6i] the potential spatial motion vector prediction candidate has essentially similar motion information than the spatial motion vector prediction candidate on the left side of the prediction unit;

[6j] for a potential spatial motion vector prediction candidate, which is on a right side of the potential spatial motion vector prediction candidate above the prediction unit, excluding the potential spatial motion vector prediction candidate from the merge list if the potential spatial motion vector prediction candidate has

essentially similar motion information than the spatial motion vector prediction candidate above the prediction unit;

[6k] for a potential spatial motion vector prediction candidate, which is below the potential spatial motion vector prediction candidate on the left side of the prediction unit, excluding the potential spatial motion vector prediction candidate from the merge list if the potential spatial motion vector prediction candidate has essentially similar motion information than the spatial motion vector prediction candidate on the left side of the prediction unit;

[6l] for a potential spatial motion vector prediction candidate cornerwise neighbouring the prediction unit, excluding the potential spatial motion vector prediction candidate from the merge list if any of the following conditions are fulfilled:

[6m] all the other potential spatial motion vector prediction candidates have been included in the merge list;

[6n] the potential spatial motion vector prediction candidate has essentially similar motion information than the spatial motion vector prediction candidate above the prediction unit;

[6o] the potential spatial motion vector prediction candidate has essentially similar motion information than the spatial motion vector prediction candidate on the left side of the prediction unit.

7. The method according to claim 1 further comprising including a temporal motion prediction candidate into the merge list.

8. The method according to claim 1 comprising selecting one motion vector prediction candidate from the merge list to represent a motion vector prediction for the block of pixels.

[15pre] An apparatus comprising a processor and a memory including computer program code, the memory and the computer program code configured to, with the processor, cause the apparatus to:

[15a] receive a block of pixels including a prediction unit;

[15b] determine a set of spatial motion vector prediction candidates for the block of pixels; the spatial motion vector prediction candidates being provided with motion information;

[15c] select a first spatial motion vector prediction candidate from the set of spatial motion vector prediction candidates as a potential spatial motion vector prediction candidate to be included in a merge list for the prediction unit, where the merge list is constructed based on the motion information of the spatial motion

vector prediction candidates and is utilized to identify motion vector prediction candidates of which one spatial motion vector prediction candidate from the merge list is signaled as the motion information for the prediction unit;

[15d] determine a subset of spatial motion vector-prediction candidates based on the location of the block associated with the first spatial motion vector prediction candidate;

[15e] compare motion information of the first spatial motion vector prediction candidate with motion information of the spatial motion vector prediction candidate in the determined subset of spatial motion vector prediction candidates without making a comparison of each possible candidate pair from the set of spatial motion vector prediction candidates, wherein comparing comprises performing an equivalence check or comparing a difference in motion information to a threshold or other similarity metric;

[15f] if at least one the comparisons indicates that the motion vector information of the spatial motion vector prediction candidates correspond with each other, exclude the first spatial motion vector prediction candidate from the merge list; and

[15g] cause information identifying the one spatial motion vector prediction candidate from the merge list to be transmitted to a decoder or to be stored.

[17pre] A non-transitory computer readable medium having stored thereon a computer executable program code for use by an encoder, said program codes comprise instructions for use by an encoder, said program code comprises instructions for:

[17a] receiving a block of pixels including a prediction unit;

[17b] determining a set of spatial motion vector prediction candidates for the block of pixels; the spatial motion vector prediction candidates being provided with motion information;

[17c] selecting a first spatial motion vector prediction candidate from the set of spatial motion vector prediction candidates as a potential spatial motion vector prediction candidate to be included in a merge list for the prediction unit, where the merge list is constructed based on the motion information of the spatial motion vector prediction candidates and is utilized to identify motion vector prediction candidates of which one spatial motion vector prediction candidate from the merge list is signaled as the motion information for the prediction unit;

[17d] determining a subset of spatial motion vector prediction candidates based on the location of the block associated with the first spatial motion vector prediction candidate;

[17e] comparing motion information of the first spatial motion vector prediction candidate with motion information of the spatial motion vector prediction candidate in the determined subset of spatial motion vector prediction candidates without making a comparison of each possible candidate pair from the set of spatial motion vector prediction candidates, wherein comparing comprises performing an equivalence check or comparing a difference in motion information to a threshold or other similarity metric;

[17f] if at least one of the comparisons indicates that the motion vector information of the spatial motion vector prediction candidates correspond with each other, excluding the first spatial motion vector prediction candidate from the merge list; and

[17g] causing information identifying the one spatial motion vector prediction candidate from the merge list to be transmitted to a decoder or to be stored.

19. The apparatus according to claim 15 wherein the apparatus is further caused to select spatial motion vector prediction candidates from the set of spatial motion vector prediction candidates as the potential spatial motion vector prediction candidate in a predetermined order.

20. The apparatus according to claim 15, wherein the apparatus is further caused to compare motion information of the potential spatial motion vector

prediction candidate with motion information of at most one other spatial motion vector prediction candidate of the set of spatial motion vector prediction candidates.

21. The apparatus according to claim 15 wherein the apparatus is further caused to examine whether the received block of pixels is divided into a first prediction unit and a second prediction unit; and if so, exclude the potential spatial motion vector prediction candidate from the merge list if the prediction unit is the second prediction unit.

[22pre] The apparatus according to claim 15, wherein the apparatus is further caused to:

[22a] determine a maximum number of spatial motion vector prediction candidates to be included in a merge list; and

[22b] limit the number of spatial motion vector prediction candidates in the merge list smaller or equal to the maximum number.

[23pre] The apparatus according to claim 22 wherein the apparatus is further caused to:

[23a] examine, if the number of spatial motion vector prediction candidates in the merge list smaller than the maximum number;

[23b] if so, examine whether the prediction unit to which the potential spatial motion vector prediction candidate belongs is available for motion prediction;

[23c] if so, perform at least one of the following:

[23d] for a potential spatial motion vector prediction candidate on a left side of the prediction unit, exclude the potential spatial motion vector prediction candidate from the merge list if any of the following conditions are fulfilled:

[23e] the received block of pixels is vertically divided into a first prediction unit and a second prediction unit;

[23f] the received block of pixels is horizontally divided into a first prediction unit and a second prediction unit, and if the prediction unit is the second prediction unit, and the potential spatial motion vector prediction candidate has essentially similar motion information than a spatial motion vector prediction candidate above the prediction unit;

[23g] for a potential spatial motion vector prediction candidate above the prediction unit, exclude the potential spatial motion vector prediction candidate from the merge list if any of the following conditions are fulfilled:

[23h] the received block of pixels is horizontally divided into a first prediction unit and a second prediction unit, and the prediction unit is the second prediction unit;

[23i] the potential spatial motion vector prediction candidate has essentially similar motion information than the spatial motion vector prediction candidate on the left side of the prediction unit;

[23j] for a potential spatial motion vector prediction candidate, which is on a right side of the potential spatial motion vector prediction candidate above the prediction unit, exclude the potential spatial motion vector prediction candidate from the merge list if the potential spatial motion vector prediction candidate has essentially similar motion information than the spatial motion vector prediction candidate above the prediction unit;

[23k] for a potential spatial motion vector prediction candidate, which is below the potential spatial motion vector prediction candidate on the left side of the prediction unit, exclude the potential spatial motion vector prediction candidate from the merge list if the potential spatial motion vector prediction candidate has essentially similar motion information than the spatial motion vector prediction candidate on the left side of the prediction unit;

[23l] for a potential spatial motion vector prediction candidate cornerwise neighbouring the prediction unit, exclude the potential spatial motion vector prediction candidate from the merge list if any of the following conditions are fulfilled:

[23m] all the other potential spatial motion vector prediction candidates have been included in the merge list;

[23n] the potential spatial motion vector prediction candidate has essentially similar motion information than the spatial motion vector prediction candidate above the prediction unit;

[23o] the potential spatial motion vector prediction candidate has essentially similar motion information than the spatial motion vector prediction candidate on the left side of the prediction unit.

24. The apparatus according to claim 15 wherein the apparatus is further caused to include a temporal motion prediction candidate into the merge list.

25. The apparatus according to claim 15 wherein the apparatus is further caused to select one motion vector prediction candidate from the merge list to represent a motion vector prediction for the block of pixels.

CERTIFICATE OF SERVICE

The undersigned hereby certifies that on October 22, 2024, true and correct copies of the foregoing Petition for *Inter Partes* Review of U.S. Patent No. 9,571,833 and Exhibits 1001-1062 were served in entirety on the Patent Owner at the following address of record as listed on Patent Center, via Federal Express®:

Nokia Corporation and Alston & Bird LLP
Vantage South End
1120 South Tryon Street, Suite 300
Charlotte, NC 28203-6818
Official Correspondence Address

The undersigned certifies that true and correct copies of the Petition for *Inter Partes* Review of U.S. Patent No. 9,571,833 and Exhibits 1001-1062 were also sent via electronic mail to the attorneys of record for Plaintiff in the concurrent litigation matter(s):

Brian E. Farnan
bfarnan@farnanlaw.com
Michael J. Farnan
mfarnan@farnanlaw.com
Warren H. Lipschitz
wlipschitz@mckoolsmith.com
Alexandra F. Easley
aeasley@mckoolsmith.com
R. Mitch Verboncoeur
mverboncoeur@mckoolsmith.com
Joshua Newcomer
jnewcomer@mckoolsmith.com
Kevin Burgess
kburgess@mckoolsmith.com
Joshua Budwin
jbudwin@mckoolsmith.com

Bryan Lutz
bryan.lutz@alston.com
Nicholas T. Tsui
nick.tsui@alston.com
Mark A. McCarty
mark.mccarty@alston.com
Shawn P. Gannon
shawn.gannon@alston.com
Stephen R. Lareau
stephen.lareau@alston.com
Theodore Stevenson, III
ted.stevenson@alston.com
John D. Haynes
john.haynes@alston.com

Dated: October 22, 2024

1540 El Camino Real Suite 120
Menlo Park, CA 94025
Tel: (650) 815-2600

/Harper Batts/

Harper Batts (Reg. No. 56,160)

Attorney for Petitioner

**CERTIFICATE OF COMPLIANCE WITH
TYPE-VOLUME LIMITATION, TYPEFACE REQUIREMENTS,
AND TYPE STYLE REQUIREMENTS**

1. This Petition complies with the type-volume limitation of 14,000 words, comprising 13,953 words, as counted using the Microsoft Word software that was used to prepare this paper, excluding the parts exempted by 37 C.F.R. § 42.24(a).

2. This Petition complies with the general format requirements of 37 C.F.R. § 42.6(a) and has been prepared using Microsoft® Word in 14-point Times New Roman.

Respectfully submitted,

SHEPPARD, MULLIN,
RICHTER & HAMPTON LLP

/Harper Batts/
Harper Batts (Reg. No. 56,160)
Attorney for Petitioner

Date: October 22, 2024

1540 El Camino Real Suite 120
Menlo Park, CA 94025
Tel: (650) 815-2673